

Principles and Practice of Clinical Virology

FOURTH EDITION

Principles and Practice of Clinical Virology

FOURTH EDITION

Edited by

Arie J. Zuckerman

Royal Free and University College Medical School, London, UK

Jangu E. Banatvala

The Guy's, King's and St Thomas' School of Medicine, London, UK

John R. Pattison

Royal Free and University College Medical School, London, UK

JOHN WILEY & SONS, LTD

Chichester • New York • Weinheim • Brisbane • Singapore • Toronto

First published 1987; Second Edition published 1990; Third Edition published 1994

Copyright © 1987, 1990, 1994, 2000 by John Wiley & Sons Ltd,
Baffins Lane, Chichester,
West Sussex PO19 1UD, England
National 01243 779777
International (+44) 1243 779777

e-mail (for orders and customer service enquiries): cs-books@wiley.co.uk
Visit our Home Page on <http://www.wiley.co.uk>
or <http://www.wiley.com>

All Rights Reserved. No part of this publication may be reproduced, stored in a retrieval system, or transmitted, in any form or by any means, electronic, mechanical, photocopying, recording, scanning or otherwise, except under the terms of the Copyright, Designs and Patents Act 1988 or under the terms of a licence issued by the Copyright Licensing Agency, 90 Tottenham Court Road, London W1P 9HE, UK, without the permission in writing of the publisher.

Other Wiley Editorial Offices

John Wiley & Sons, Inc., 605 Third Avenue,
New York, NY 10158-0012, USA

WILEY-VCH Verlag GmbH, Pappelallee 3,
D-69469 Weinheim, Germany

Jacaranda Wiley Ltd, 33 Park Road, Milton,
Queensland 4064, Australia

John Wiley & Sons (Asia) Pte Ltd, 2 Clementi Loop #02-01,
Jin Xing Distripark, Singapore 129809

John Wiley & Sons (Canada) Ltd, 22 Worcester Road,
Rexdale, Ontario M9W 1L1, Canada

Library of Congress Cataloging-in-Publication Data

Principles and practice of clinical virology / edited by Arie J. Zuckerman,
Jangu E. Banatvala, John R. Pattison. — 4th ed.

p. cm.

Includes bibliographical references and index.

ISBN 0-471-97340-8

1. Virus diseases 2. Medical virology. I. Zuckerman, Arie J.

II. Banatvala, J. E. III. Pattison, J. R. (John Ridley) IV. Title: Clinical virology.

[DNLM: 1. Virus Diseases. WC 500 P957 2000]

RC114.5.P66 2000

616.9'25—dc21

DNLM/DLC

for Library of Congress 98-50139

CIP

British Library Cataloguing in Publication Data

A catalogue record for this book is available from the British Library

ISBN 0-471-97340-8

Typeset in 10/11.5pt Times from the authors' disks by Vision Typesetting, Manchester
Printed and bound in Great Britain by Bookcraft (Bath) Ltd, Midsomer Norton, Somerset
This book is printed on acid-free paper responsibly manufactured from sustainable forestry,
in which at least two trees are planted for each one used for paper production.

Contents

List of Contributors	vii	4 Viruses Associated with Acute Diarrhoeal Disease	235
Preface	xi	<i>Ulrich Desselberger</i>	
Preface to the Third Edition	xii	5 Influenza	253
Preface to the Second Edition	xiii	<i>Chris W. Potter</i>	
Preface to the First Edition	xiv	6 Parainfluenza Viruses	279
Plates	xv	<i>Donald M. McLean</i>	
1 Diagnostic Approaches	1	7 Respiratory Syncytial Virus	293
<i>Deenan Pillay</i>		<i>Caroline B. Hall</i>	
2 The <i>Herpesviridae</i>	19	8 Adenoviruses	307
<i>Graham M. Cleator and Paul E. Klapper</i>		<i>Göran Wadell</i>	
2A Herpes Simplex	23	9 Rhinoviruses	329
<i>Graham M. Cleator and Paul E. Klapper</i>		<i>Nikolaos G. Papadopoulos and Sebastian L. Johnston</i>	
2B Varicella Zoster	47	10 Coronaviruses and Toroviruses	345
<i>Judith Breuer, David R. Harper and Hillar O. Kangro</i>		<i>David Cavanagh</i>	
2C Cytomegalovirus	79	11 Measles	357
<i>Paul D. Griffiths</i>		<i>Sibylle Schneider-Schaulies and Volker ter Meulen</i>	
2D Epstein–Barr Virus	117	12 Rubella	387
<i>Dorothy H. Crawford</i>		<i>Jennifer M. Best and Jangu E. Banatvala</i>	
2E Human Herpesviruses 6 and 7 . .	141	13 Mumps	419
<i>Ursula A. Gompels</i>		<i>Pauli Leinikki</i>	
2F Kaposi’s Sarcoma-associated Herpesvirus (Human herpesvirus 8)	167	14 Enteroviruses	427
<i>Thomas F. Schulz</i>		<i>Philip D. Minor, Peter Morgan-Capner and Peter Muir</i>	
3 Hepatitis Viruses	187	15 Poxviruses	451
<i>Tim J. Harrison, Geoffrey M. Dusheiko and Arie J. Zuckerman</i>		<i>Derrick Baxby</i>	

16	Alphaviruses	467	22	Papillomaviruses	607
	<i>Nicola S. Brink and Graham Lloyd</i>			<i>Dennis J. McCance</i>	
17	Flaviviruses	485	23	Human Polyomaviruses	619
	<i>Barry D. Schoub and Nigel K. Blackburn</i>			<i>Kristina Dörries</i>	
18	Bunyaviridae	515	24	Human Parvoviruses	645
	<i>Robert Swanepoel</i>			<i>John R. Pattison</i>	
19	Arenaviruses	551	25	Human Immunodeficiency Viruses	659
	<i>Colin R. Howard</i>			<i>Robin A. Weiss, Angus G. Dalglish and Clive Loveday</i>	
20	Filoviruses	571	25A	Human T-Cell Lymphotropic Viruses	695
	<i>Colin R. Howard</i>			<i>Graham P. Taylor</i>	
21	Rabies	583	26	Human Prion Diseases	711
	<i>Karl G. Nicholson</i>			<i>Stanley B. Prusiner</i>	
			Index		749

Contributors

Jangu E. Banatvala Professor, Department of Virology, King's College London (The Guy's, King's and St Thomas' School of Medicine), St Thomas' Hospital, Lambeth Palace Road, London SE1 7EH, UK

Derrick Baxby Senior Lecturer, Department of Medical Microbiology and Genitourinary Medicine, The University of Liverpool, Duncan Building, Daulby Street, Liverpool L69 3GA, UK

Jennifer M. Best Reader in Virology and Chairperson of the European Society for Clinical Virology, Department of Virology, King's College London (The Guy's, King's and St Thomas' School of Medicine), St Thomas' Hospital, Lambeth Palace Road, London SE1 7EH, UK

Nigel K. Blackburn Deputy Director, National Institute for Virology, University of Witwatersrand, Private Bag X4, Sandringham 2131, South Africa

Judith Breuer Consultant Virologist, Department of Virology, St Bartholomew's and the Royal London School of Medicine and Dentistry, 51–53 Bartholomew Close, West Smithfield, London EC1A 7BE, UK

Nicola S. Brink Consultant Virologist and Honorary Senior Lecturer, Division of Virology, Royal Free and University College Medical School, Windeyer Building, 46 Cleveland Street, London W1P 6DP, UK

David Cavanagh Institute for Animal Health, Compton Laboratory, Compton, Newbury, Berkshire RG20 7NN, UK

Graham M. Cleator Reader in Medical Virology, Department of Pathological Sciences, University of Manchester, Stopford Building, Oxford Road, Manchester M13 9PT, UK

Dorothy H. Crawford Professor of Medical Microbiology, University of Edinburgh Medical School, Teviot Place, Edinburgh EH8 9AG, UK

Angus G. Dalgleish Professor, Division of Oncology, St George's Hospital Medical School, Cranmer Terrace, London WC1E 7HT, UK

Ulrich Desselberger Director, Public Health and Clinical Microbiology Laboratory, Box 236, Addenbrooke's Hospital, Hills Road, Cambridge CB2 2QW, UK

Kristina Dörries Senior Research Scientist, Institute of Virology and Immunobiology, Julius-Maximilians University, Versbacher Strasse 7, D-97078 Würzburg, Germany

Geoffrey M. Dusheiko Professor of Medicine, Department of Medicine, Royal Free and University College Medical School, Rowland Hill Street, London NW3 2PF

Ursula A. Gompels Senior Lecturer in Virology, Department of Infectious and Tropical Diseases, London School of Hygiene & Tropical Medicine, University of London, Keppel Street, London WC1E 7HT, UK

Paul D. Griffiths Professor of Virology, Royal Free and University College Medical School, Rowland Hill Street, London NW3 2PF, UK

Caroline B. Hall Professor of Pediatrics and Medicine in Infectious Diseases, University of Rochester School of Medicine, 601 Elmwood Avenue, Box 689, Rochester, NY 14642, USA

David R. Harper Lecturer in Molecular Virology, Department of Virology, St Bartholomew's and the Royal London School of Medicine and Dentistry, 51–53 Bartholomew Close, West Smithfield, London EC1A 7BE, UK

Tim J. Harrison *Reader in Molecular Virology, Royal Free and University College Medical School, Rowland Hill Street, London NW3 2PF, UK*

Colin R. Howard *Vice-Principal for Research, Department of Pathology and Infectious Diseases, Royal Veterinary College, University of London, Royal College Street, London NW1 0TU, UK*

Sebastian L. Johnston *Senior Lecturer in Medicine, University Medicine, Level D, Centre Block (810), Southampton General Hospital, Tremona Road, Southampton SO16 6YD, UK*

Hillar O. Kangro *Vaccines Epidemiologist (formerly Reader in Virology), SmithKline Beecham Plc, New Horizons Court, Great West Road, Brentford, Middlesex TW9 9EP, UK*

Paul E. Klapper *Principal Clinical Scientist (NHS) and Honorary Lecturer in Medical Virology, Department of Clinical Virology, 3rd Floor, Clinical Sciences Building, Manchester Royal Infirmary, Oxford Road, Manchester M13 9WL, UK*

Pauli Leinikki *Professor, Department of Infectious Disease Epidemiology, National Public Health Institute, Mannerheimintie 166, FIN-00300, Helsinki, Finland*

Graham Lloyd *Head of Category 4 and Reference Laboratory, Centre for Applied Microbiology and Research, Porton Down, Salisbury, Wiltshire SP4 0JG, UK*

Clive Loveday *Professor, Department of Retrovirology, Royal Free and University College Medical School, Rowland Hill Street, London NW3 2PF, UK*

Dennis J. McCance *Professor, Microbiology and Immunology and Cancer Center, and Head, Virology Unit, University of Rochester Medical Center, Box 672, 601 Elmwood Avenue, Rochester NY 1462, USA*

Donald M. McLean *Professor Emeritus, Department of Pathology and Laboratory Medicine, University of British Columbia Faculty of Medicine, 2211 Wesbrook Mall, Vancouver, BC, Canada V6T 2B5*

Philip D. Minor *Head, Division of Virology, National Institute for Biological Standards and Control, Blanche Lane, South Mimms, Potters Bar, Hertfordshire EN6 3QG, UK*

Peter Morgan-Capner *Clinical Virologist, Public Health Laboratory, Royal Infirmary, Meadow Street, Preston PR1 6PS, UK*

Peter Muir *Lecturer, Department of Virology, King's College London (The Guy's, King's and St Thomas' School of Medicine, St Thomas' Hospital, Lambeth Palace Road, London SE1 7EH, UK*

Karl G. Nicholson *Senior Lecturer in Infectious Diseases, Ward 38, Leicester Royal Infirmary, Infirmary Square, Leicester LE1 5WW, UK*

Nikolaos G. Papadopoulos *Clinical Research Fellow, University Medicine, Level D, Centre Block (810), Southampton General Hospital, Tremona Road, Southampton SO16 6YD, UK*

Sir John R. Pattison *Vice-Provost, University College London, Gower Street, London WC1E 6BT, UK*

Deenan Pillay *Consultant Medical Virologist and Head of PHLs Antiviral Susceptibility Reference Unit, Public Health Laboratory Service, Antiviral Susceptibility Reference Unit, Department of Infection, Medical School, University of Birmingham, Edgbaston, Birmingham B15 2TT, UK*

Chris W. Potter *Director, Institute for Cancer Studies, University of Sheffield Medical School, Beech Hill Road, Sheffield S10 2RX, UK*

Stanley B. Prusiner *Professor, Department of Neurology, HSE-781, School of Medicine, University of California, San Francisco, CA 94143-0518, USA*

Sibylle Schneider-Schaulies *Lecturer, Institute of Virology and Immunobiology, Julius-Maximilians University, Versbacher Strasse 7, D-97078 Würzburg, Germany*

Barry D. Schoub *Director, National Institute for Virology, University of Witwatersrand, Private Bag X4, Sandringham 2131, South Africa*

Thomas F. Schulz *Professor of Genitourinary Medicine, Department of Medical Microbiology, University of Liverpool, Duncan Building, Daulby Street, Liverpool L69 3GA, UK*

Robert Swanepoel *Professor, National Institute for Virology, University of Witwatersrand, Private Bag X4, Sandringham 2131, South Africa*

Graham P. Taylor *Clinical Trials Centre, Winston*

*Churchill Wing, Imperial College School of
Medicine, St Mary's Hospital, Praed Street, London
W2 1PG, UK*

Volker ter Meulen *Professor of Virology and
Chairman, Institute of Virology and Immunology,
University of Würzburg, Versbacher Strasse 7,
D-8700 Würzburg, Germany*

Göran Wadell *Department of Virology, University*

of Umeå, S-901 85 Umeå, Sweden

Robin A. Weiss *Professor and Head of
Department, Wohl Virion Centre, Windeyer Institute
of Medical Sciences, Windeyer Building, 46
Cleveland Street, London W1P 6DB*

Arie J. Zuckerman *Principal and Dean, and
Professor of Medical Microbiology, Royal Free and
University College Medical School, Rowland Hill
Street, London NW3 2PF, UK*

Preface

It is now thirteen years since the First Edition of *Principles and Practice of Clinical Virology* was published. A comparison of the first and fourth editions testifies to the rapid expansion in virology during the intervening years, including major developments in technology, the application of these to clinical practice and advances in the treatment of viral infections with an increasing number of antiviral drugs. Indeed, such has been the progress in the field of clinical virology even within the period between the third and fourth editions that we have asked a number of new authors to contribute chapters. These include the chapters on rhinoviruses, viruses associated with acute diarrhoeal disease, and human polyomaviruses. Of the remaining chapters, virtually all have been revised substantially. The chapter on the *herpesviridae* has been expanded considerably, particularly in relation to *Human herpes viruses 6, 7 and 8*; new authors have contributed to these sections. The chapter on hepatitis viruses reflects the considerable expansion of information relating to hepatitis E and C as well as the role of such newly recognised agents as GB and the new human virus, TTV.

Advances in diagnostic methods, particularly

molecular biological techniques and their application to clinical problems, are reflected in a new chapter on 'Diagnostic Approaches', which presents an overview of the value and limitations of established and more recently developed techniques. Advances in serological techniques as well as in virus identification are emphasised. This chapter also includes an important section on assays for determining antiviral drug resistance.

Most of the chapters reflect advances in patient management, including—where appropriate—antiviral chemotherapy. As expected, the chapters on hepatitis viruses and human retroviruses have been expanded considerably in the light of continuing and rapid advances in these fields. Both chapters now include a component by authors with everyday practical experience in the management and treatment of patients with these infections.

In comparison with the third edition, more coloured plates have been included, which we hope our readers will appreciate. As in previous editions, we have attempted to limit the reference lists to key publications.

A. J. Zuckerman
J. E. Banatvala
J. R. Pattison

Preface to the Third Edition

Principles and Practice of Clinical Virology was first published in 1987; a third edition within seven years of the first attests to the continuing and rapid progress in the field of clinical virology.

All the chapters have been revised and some completely rewritten, reflecting the increasing knowledge of viruses or groups of viruses included in the various chapters. Thus, the chapter on hepatitis viruses now contains sections on hepatitis A and E viruses as well as individual contributions on hepatitis B, D and C. The previous edition contained two chapters on viral haemorrhagic fevers but this section now includes separate chapters for the flaviviruses, alphaviruses, *Bunyaviridae*, arenaviruses and filoviruses. The chapters on arenaviruses and filoviruses have been contributed by new authors.

New authors have also contributed the chapter on herpes simplex virus infections and the chapter on the more newly-recognized herpes viruses now includes a section on human herpes virus 7.

As expected, rapid developments continue to occur in the field of human retroviruses, particularly the human immunodeficiency viruses, and this chapter reflects the accumulation of new and important data in this area. The chapter on human prion disease has been almost entirely rewritten to reflect many of the substantial advances in prion research.

Most of the authors stress the developments and application of molecular biological techniques which are leading not only to improved methods of diagnosis but also to an increased understanding of viral pathogenesis.

Rather than burden readers with a large number of references, we have aimed to include most of the key ones.

Finally, we are grateful for the helpful comments which we received from many of our readers; some of their suggestions have been incorporated into the third edition.

A. J. Zuckerman
J. E. Banatvala
J. R. Pattison

Preface to the Second Edition

In the preface to the first edition of *Principles and Practice of Clinical Virology* we stated that it was our intention, with new editions, to remain up to date as the subject advanced. Such is the pace of development in clinical virology that plans were laid for a new edition within a few months of the first being published, and this second edition is appearing only two and a half years after the first. Each chapter has been revised, many extensively, to take account of progress in the understanding of the epidemiology, pathogenesis, diagnosis, management and prevention of virus infections. Perhaps the greatest single recent contribution to the subject has been made by the application of molecular biological techniques, and each of our authors has highlighted the contribution of this rapidly developing discipline to clinical virology.

Human herpesvirus 6 is now the subject of a new chapter, and we have also added a new chapter on haemorrhagic fevers to include much new information on their pathogenesis. As expected, the extensive accumulation of new information relating to infection by human retroviruses has resulted in extensive updating of this chapter, not only to include

much more information on human immunodeficiency viruses but also on HTLV-1 and -2. The chapter on hepatitis has been separated into two sections: the first on hepatitis A and the viruses causing non-A, non-B hepatitis, two of which have been identified as hepatitis C and E, and the second on hepatitis B and D (delta agent).

As before, we were aware when organizing the book that no single arrangement is entirely satisfactory. We have chosen to arrange the chapters on the basis of individual viruses or groups of viruses. General chapters on virus structure, taxonomy and pathogenesis are not included, but the information on these aspects necessary for an understanding of the practice of clinical virology is included in the individual chapters.

Such factors as the likely discovery of yet new viruses, improvements in the rapidity and sensitivity of diagnostic techniques, and the development of new vaccines, which are likely to involve recombinant techniques and progress in antiviral therapy, will ensure that thought will be given to revision and preparation of another edition.

A. J. Zuckerman
J. E. Banatvala
J. R. Pattison

Preface to the First Edition

There has been a spectacular increase during the last thirty years in our knowledge of virology. This has taken place to such an extent that virology can now be regarded as an umbrella term encompassing a variety of distinct but related disciplines. There are fundamental connections with biochemistry, genetics and molecular biology, and each of these aspects would be worth a treatise in itself. Clinical virology is that aspect which is concerned with the cause, diagnosis, treatment and prevention of virus infections of man. It too has acquired a substantial body of knowledge and accumulated experience over the past thirty years and this book is intended to be an authoritative account of the present situation. Formerly virological diagnosis was time consuming, retrospective and rarely influenced the management of the patient. During the past 10–15 years the picture has changed dramatically. Newly recognized diseases such as AIDS and some haemorrhagic fevers which have very serious consequences for individuals and populations have been shown to be due to viruses. In the clinical virology laboratory there has been a change in emphasis towards rapid diagnostic techniques. Finally, effective anti-viral chemotherapy is a reality at least for some virus infections and there has been an expansion in the use of immunoprophylaxis. Thus the current principles and practice of clinical virology

are concerned with rapid laboratory diagnosis leading to appropriate patient management which might involve specific therapy and/or infection control measures at a hospital, a national and occasionally at an international level.

In organizing the book we were aware that there is no single arrangement that is entirely satisfactory. We have chosen to arrange the chapters on the basis of individual viruses or groups of viruses. General chapters on virus structure, taxonomy and pathogenesis are not included but the information on these aspects necessary for an understanding of the practice of clinical virology is included in the individual chapters.

Clinical virology is a subject which continues to evolve. This is usually for one of two reasons, either the need to apply new technology or the need to study new diseases or epidemiological situations. We have therefore invited authors who are specialist investigators into each of the viruses to contribute up-to-date, stimulating accounts of the practice of clinical virology and provide a framework for the assimilation of imminent advances. One chapter has already had to be significantly updated during the time of preparation of the book and it is our intention, with new editions, to remain up-to-date as the subject advances.

A. J. Zuckerman
J. E. Banatvala
J. R. Pattison

Plates



Figure 2A.3 'Cold sores' at the pustular and crusting stages



Figure 2A.4 Rose Bengal staining of herpes simplex virus dendritic ulceration in a grafted cornea. (Kindly provided by R. E. Bonshek and A. B. Tullo)

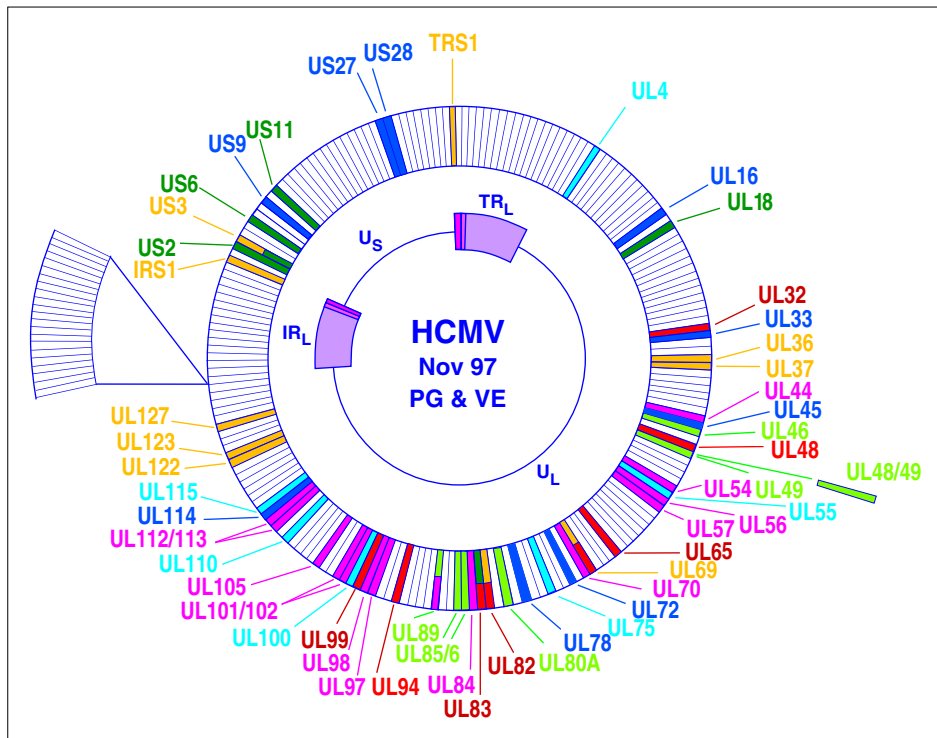

Figure 2C.4 Proteins of CMV which have been mapped to date. UL = unique long region; US = unique short region; TR = terminal repeat; IR = inverted repeat. The genome is linear within the virus but has been circularized for convenience. Open reading frames of known function are coloured according to the following code: orange = transactivators; pink = DNA replication; green = capsid and/or assembly; red = tegument; pale blue = envelope; dark green = immune evasion; dark blue = miscellaneous

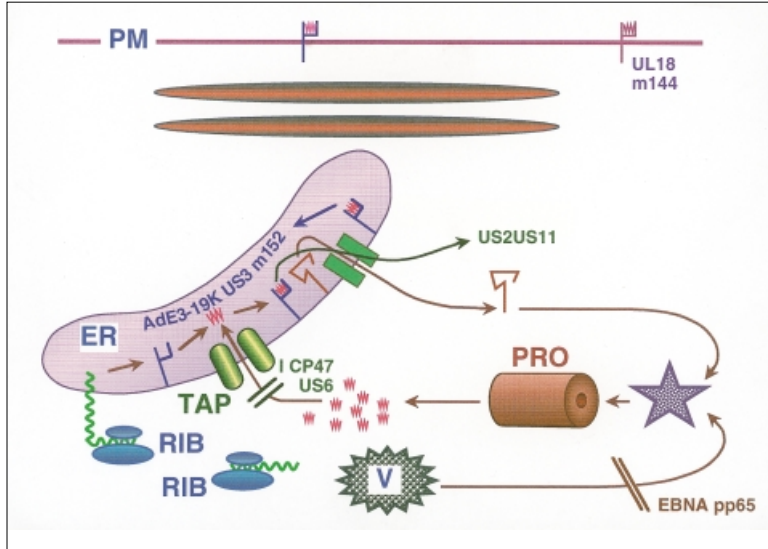

Figure 2C.7 The ways viruses can interfere with presentation of HLA–peptide complexes at the plasma membrane. RIB = ribosome; ER = endoplasmic reticulum; V = virus-encoded protein; PRO = proteasome; PM = plasma membrane; TAP = transporter associated with antigen presentation. Peptides derived from virus-infected cells are generated in the proteasome and actively transported by TAP into the lumen of the ER. A ribosome is shown producing a protein with a signal peptide, which folds in the ER to produce the HLA class I chain. This should normally associate with peptide and be transported to the plasma membrane. Misfolded HLA molecules can be re-exported from the lumen of the ER back into the cytosol, where they are degraded by the proteasome. Virus-encoded genes interfere with this process as follows: the proteins may be inherently unsusceptible to proteasome digestion (EBNA of EBV) or may be modified to reduce their digestion (pp65 acts on MIE protein of human CMV). Proteins may block the function of TAP (ICP47 of HSV; US6 of human CMV). Proteins may bind mature class I molecules within the ER and so sequester them (E3–19K protein of adenoviruses; US3 protein of HCMV; m152 protein of MCMV). Two proteins of HCMV (US2 and US11) facilitate the re-export from the ER to the cytosol of mature HLA class I molecules. If all of these mechanisms are completely successful, the level of HLA display at the PM will be insufficient to prevent NK cells recognizing the cell as being abnormal and so destroying it. Proteins encoded within HCMV (UL18) or MCMV (m144) are thus presented at the plasma membrane to act as a decoy for NK cells

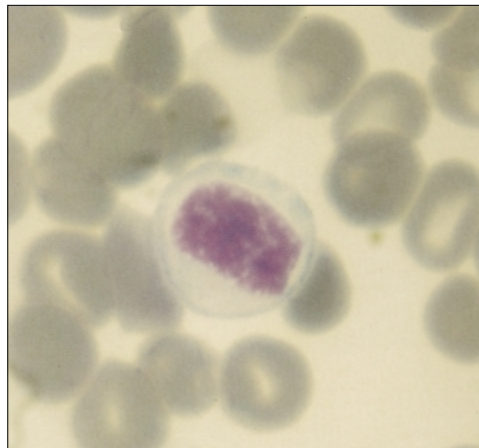

Figure 2D.7 Photomicrograph of a May–Grunwald–Giemsa-stained peripheral blood film from acute infectious mononucleosis. An atypical mononuclear cell is illustrated. (x 1000)



Figure 2E.6 The classical roseola infantum rash in a 10-month-old child. (Reproduced with permission from Stammers, 1988)

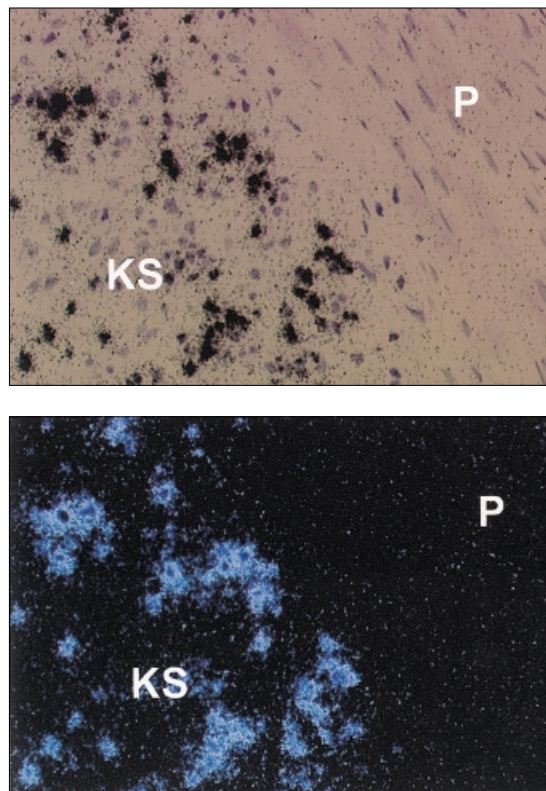

Figure 2F.4 Expression of the latent ORF K12/T0.7 mRNA in KS spindle (endothelial tumour) cells by *in situ* hybridization, as reported in Stürzl *et al.* (1997). The majority of spindle cells expresses this transcript which is indicative of latent infection (see text). KS = KS tissue; P = surrounding tissue. Bottom panel: dark field. (Courtesy M. Stürzl, Munich)



Figure 24.4 The slapped-cheek appearance commonly seen in children following B19 infection. (Reproduced with the permission of Dr A. du Vivier, King's College Hospital, London)

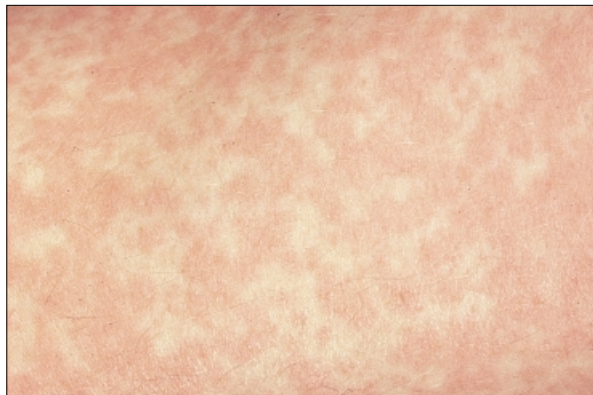

Figure 24.5 The maculopapular rash on the trunk of an adult infected with *B19 virus*



Figure 24.6 The lacy or reticular appearance of the rash on the limb of a girl infected with *B19 virus*. (Reproduced with permission from Parvoviruses: Medical and Biological Aspects, Pattison, J. R. in *Field's Virology*, 2nd edition 1990, p. 1769)

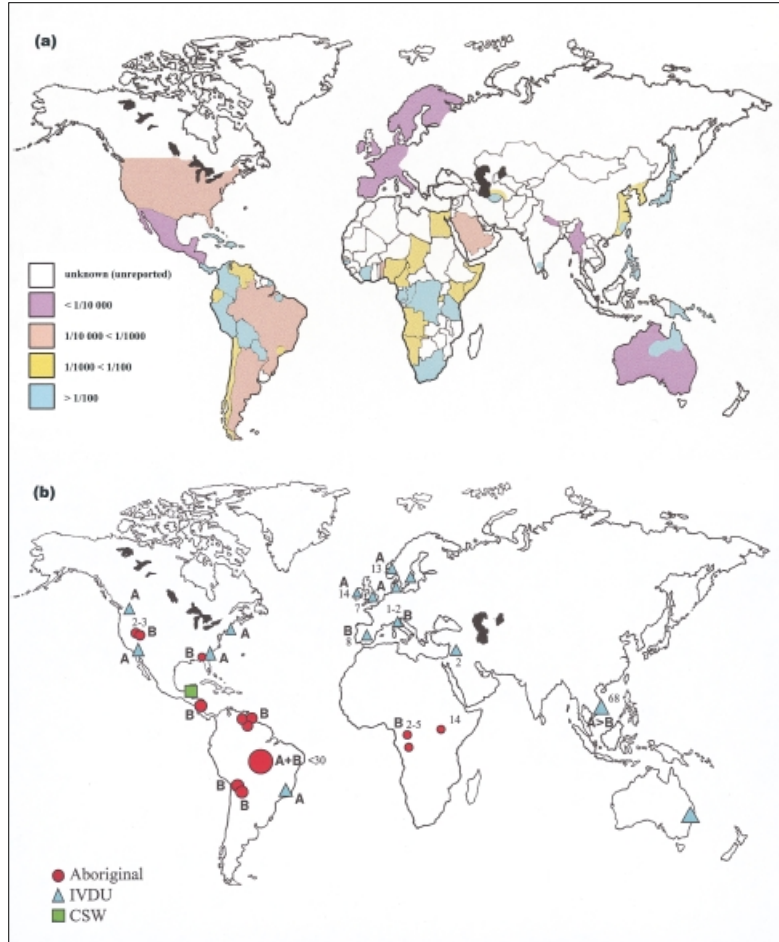

Figure 25A.4 Global seroprevalence of (a) HTLV-I and (b) HTLV-II. Lettering refers to HTLV-II subtypes; numbering is percent of population sample infected with HTLV-II; symbol size relates to size of population; IDVU = intravenous drug user; CSW = commercial sex worker. (Courtesy of the Audiovisual Department at Imperial College School of Medicine, St Mary's Hospital)

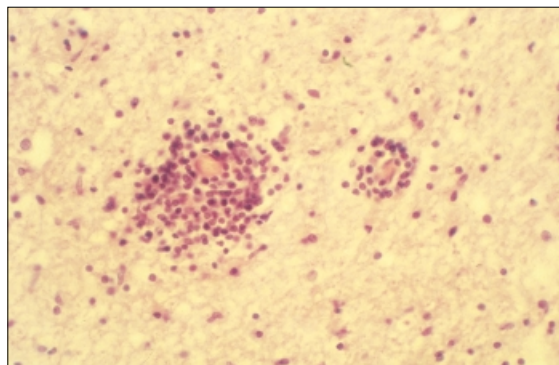

Figure 25A.7 Perivascular lymphocytic infiltration in the central nervous system. (Courtesy of Dr Margaret Esiri)

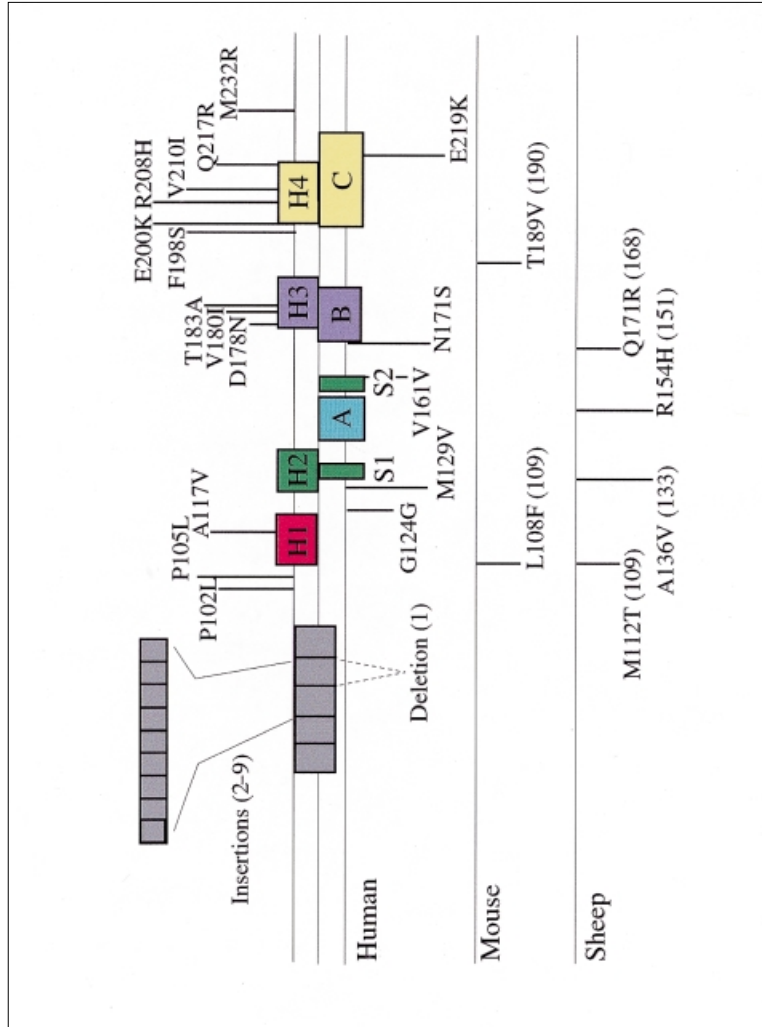

Figure 26.1 Mutations of the prion protein gene. Mutations causing inherited human prion disease and polymorphisms in human, mouse and sheep. Above the line of the human sequence are mutations that cause prion disease. Below the lines are polymorphisms, some but not all of which are known to influence the onset as well as the phenotype of disease. (Data compiled by Paul Barnborough and Fred E. Cohen; from Prasher, S. B. (1997) *Science*, **278**, 245-251)

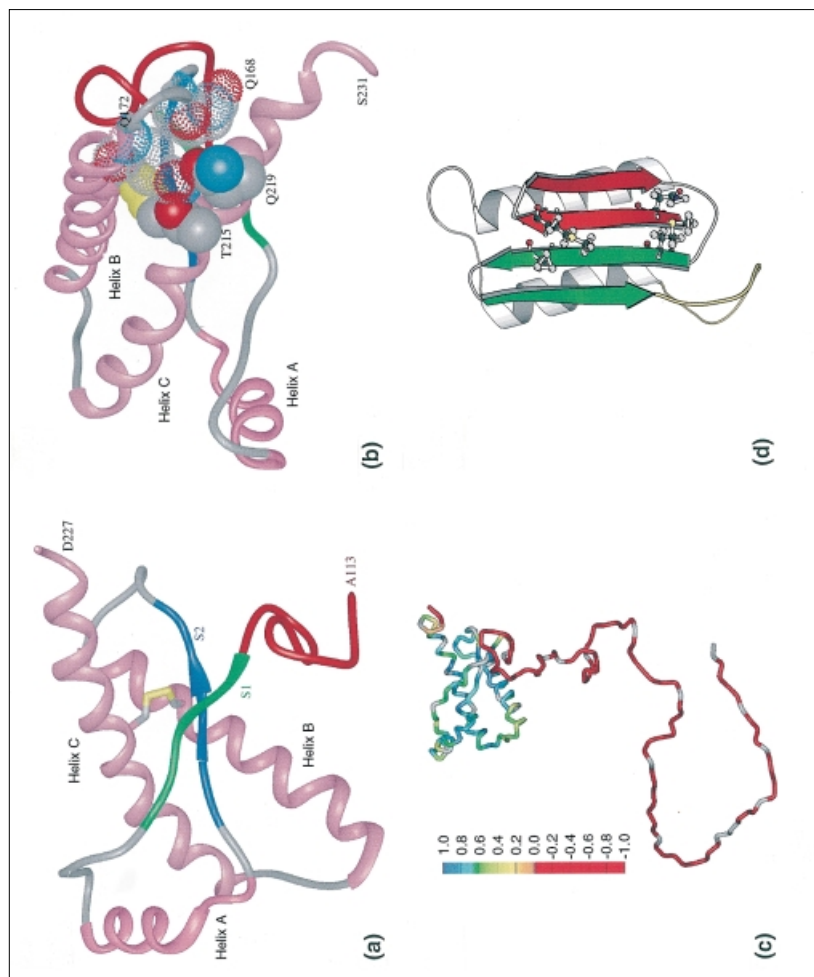

Figure 26.3 Structures of prion proteins. (A) NMR structure of Syrian hamster (SHa) recombinant (r) PrP(90–231). Presumably, the structure of the α -helical form of rPrP(90–231) resembles that of PrPC. rPrP(90–231) is viewed from the interface where PrPSc is thought to bind to PrPC. The color scheme is: α -helices A (residues 144–157), B (172–193) and C (200–227) in pink; disulphide between Cys179 and Cys214 in yellow; conserved hydrophobic region composed of residues 113–126 in red; loops in grey; residues 129–134 in green encompassing strand S1 and residues 159–165 in blue encompassing strand S2; the arrows span residues 129–131 and 161–163, as these show a closer resemblance to β sheet (James *et al.*, 1997). (B) NMR structure of rPrP(90–231) is viewed from the interface where protein X is thought to bind to PrPC. Protein X appears to bind to the side-chains of residues that form a discontinuous epitope; some amino acids are in the loop composed of residues 165–171 and at the end of helix B (Gln168 and Gln172 with a low density van der Waals rendering), while others are on the surface of helix C (Thr215 and Gln219 with a high density van der Waals rendering) (Kaneko *et al.*, 1997). (C) Diagram showing the flexibility of the polypeptide chain form PrP(29–231) (Donne *et al.*, 1997). The structure of the portion of the protein representing residues 90–231 was taken from the coordinates of PrP(90–231) (James *et al.*, 1997). The remainder of the sequence was hand-built for illustration purposes only. The color scale corresponds to the heteronuclear $\{^1\text{H}\}-\{^{15}\text{N}\}$ NOE data: red for the lowest (most negative) values, where the polypeptide is most flexible, to blue for the highest (most positive) values in the most structured and rigid regions of the protein. (D) Plausible model for the tertiary structure of human PrPSc (Huang *et al.*, 1995). Color scheme is: S1 β strands are 108–113 and 116–122 in red; S2 β strands are 128–135 and 138–144 in green; α helices H3 (residues 178–191 and H4 (residues 202–218 in grey; loop) (residues 142–177 in yellow. Four residues implicated in the species barrier are shown in ball-and-stick form (Asn108, Met112, Met129, Ala133). (a) and (b) from Prusiner, S.B. *et al.* (1998) Cell, **93** 337–348; (c) from Donne *et al.*, 1997 (d) from Prusiner, S.B. (1997) *Science*, **278**, 245–251)

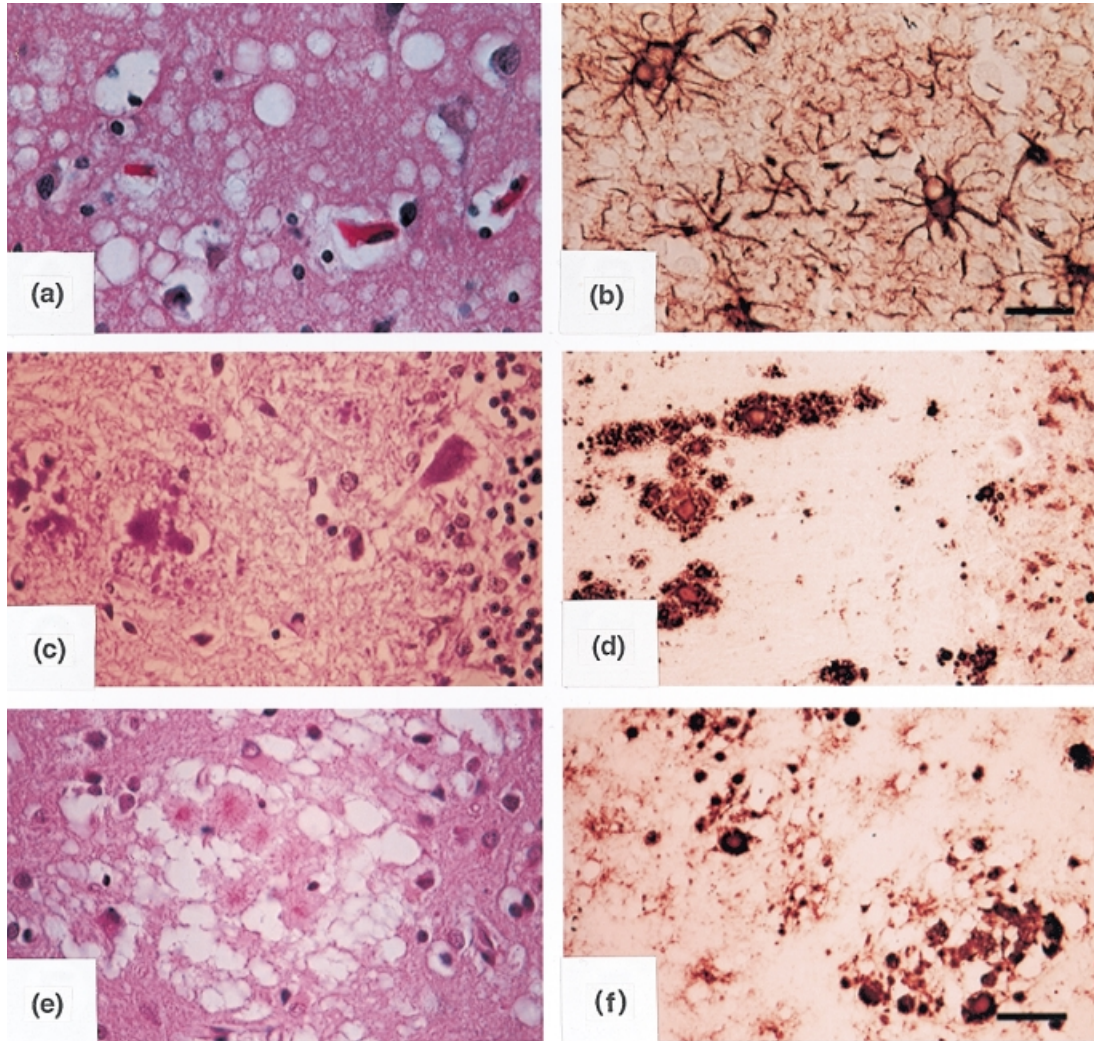

Figure 26.4 Neuropathology of human prion diseases. Sporadic CJD is characterized by vacuolation of the neuropil of the grey matter, by exuberant reactive astrocytic gliosis, the intensity of which is proportional to the degree of nerve cell loss, and rarely by PrP amyloid plaque formation (not shown). The neuropathology of familial CJD is similar. GSS(P102L), as well as other inherited forms of GSS (not shown) is characterized by numerous deposits of PrP amyloid throughout the CNS. The neuropathological features of vCJD are unique among CJD cases because of the abundance of PrP amyloid plaques that are often surrounded by a halo of intense vacuolation (A) Sporadic CJD, cerebral cortex stained with haematoxylin and eosin showing widespread spongiform degeneration. (B) Sporadic CJD, cerebral cortex immunostained with anti-GFAP antibodies demonstrating the widespread reactive gliosis. (C) GSS, cerebellum with most of the GSS plaques in the molecular layer (left 80% of micrograph), and many but not all are periodic acid–Schiff (PAS) reaction positive. Granule cells and a single Purkinje cell are seen in the right 20% of the panel. (D) GSS, cerebellum at the same location as (C) with PrP immunohistochemistry after the hydrolytic autoclaving reveals more PrP plaques than seen with the PAS reaction (E) Variant CJD, cerebral cortex stained with haematoxylin and eosin shows the plaque deposits uniquely located within vacuoles. With the histology, these amyloid deposits have been referred to as ‘florid plaques’. (F) Variant CJD, cerebral cortex stained with PrP immunohistochemistry after hydrolytic autoclaving reveals numerous PrP plaques often occurring in clusters as well as minute PrP deposits surrounding many cortical neurons and their proximal processes. (Bar in (a)–(c) and (e) = 50µm; Bar in (d) and (f) = 100 µm.) (Photomicrographs prepared by Stephen J. DeArmond. Variant CJD specimens provided by James Ironside, Jeanne Bell and Robert Will. From Prusiner, S.B. *et al.* (in press) *The prion diseases*. In *Alzheimer Disease*. Lippincott Williams and Wilkins, Philadelphia)

Diagnostic Approaches

Deenan Pillay

Birmingham Public Health Laboratory and University of Birmingham, UK

INTRODUCTION

If clinical virology in the 1980s was characterized by the widespread use of enzyme-linked immunosorbent assay (ELISA) technology, then there is no doubt that the 1990s will be seen as the period when molecular biological methods of virus detection entered routine diagnostic use. Concurrently, the emphasis and priorities of diagnostic virology laboratories have shifted in response to identification of new viruses, many of which are non-, or poorly, cultivatable; the increasing availability of effective antiviral agents; the increasing number of immunocompromised patients, in whom opportunistic viral infections are life-threatening; and new cost-pressures on pathology services.

The time of retrospective viral diagnosis has gone, to be replaced by rapid techniques which impact directly on patient management. More competition for health care resources mean that new techniques are introduced at the expense of more traditional methods with limited clinical use. Most importantly, clinical virologists are having to work closer with their clinical colleagues to establish new diagnostic criteria, develop protocols for use of antiviral drugs, and for monitoring of those patients with persistent infections.

This chapter provides an overview of diagnostic techniques against this background, and highlights those clinical scenarios of particular importance to virologists in a diagnostic setting.

TECHNIQUES—AN OVERVIEW

Virus Isolation

Many of the advances in clinical virology have come about because of the ability to propagate viruses in the laboratory. Virus isolation cell culture techniques remain the cornerstone of many clinical virology laboratories. With appropriate specimens, and optimal cell lines, this technique can be highly sensitive and specific, and a presumptive diagnosis made on the basis of a characteristic cytopathic effect (CPE), confirmed by immunostaining. The judicious use of two or three cell lines, such as a monkey kidney line, a human continuous cell line and a human fibroblast line will allow the detection of the majority of cultivatable viruses of clinical importance, such as herpes simplex virus (HSV), *Varicella zoster virus* (VZV), cytomegalovirus (CMV), enteroviruses, respiratory syncytial virus (RSV), adenovirus, parainfluenza viruses, influenza viruses and rhinoviruses. In addition, the ability to grow virus from a clinical specimen demonstrates the presence of viable virus (albeit viable within the chosen cell line)—this is not necessarily the case with detection of viral antigen or genome. For example, following initiation of antiviral therapy for genital herpes, HSV antigen can be detected from genital swabs for longer than by virus propagation in cell culture. This infers that antigen persists in the absence of viral replication and under-

Table 1.1 Virus isolation

Advantages	Disadvantages
Sensitive	Slow (conventional cell culture)
'Catch all'	Labour intensive
Generates isolate for further study	Multiple cell lines required
Detects 'viable' virus	
Adaptation for rapid result	

lines the importance of correct interpretation of laboratory results. Nevertheless, virus isolation has now been shown to be less sensitive than molecular amplification methods for this and other viruses (see later).

The major advantage of virus isolation is the ability to undertake further examination of the isolate, such as drug susceptibility assays (see later) or typing (Table 1.1). The latter provides important epidemiological information, such as identification and tracking of new influenza strains.

By contrast, routine cell culture techniques available in most laboratories will not detect a number of clinically important viruses such as gastroenteritis viruses, hepatitis viruses, *Epstein-Barr virus* (EBV), *Human herpesvirus 6, 7 and 8* (HHV-6, -7, -8), and/or human immunodeficiency virus (HIV). Other than HSV, for which most isolates will grow in human fibroblast cells within 3 days, the time for CPE (or, for example, haemadsorption) to develop for most clinical viral isolates is between 7 and 21 days. For this reason, a number of modifications to conventional cell culture have been reported, to provide more rapid results. These include centrifugation of specimens on to cell monolayers, often on cover slips, and immunostaining with viral protein specific antibodies at 48–72 hours following inoculation (e.g. Stirk and Griffiths, 1988). Such techniques can also be undertaken in microtitre plates (O'Neill *et al.*, 1996).

The role of conventional cell culture for routine diagnosis of viral infections is diminishing. Increasingly, antigen or genome detection methods are replacing virus isolation for diagnosis of key viral infections (usually those which are treatable, such as CMV and VZV). Nevertheless, it is important for large laboratories to maintain the ability to employ this methodology for the reasons given above. Where primary diagnosis is undertaken by cell culture, there will be increasing pressure to generate

quicker results by use of the many rapid techniques that have been reported.

Antigen Detection

Immunofluorescence

One of the most effective rapid diagnostic tests is indirect or direct immunofluorescence (IF). Initially undertaken with polyclonal antisera, and then subsequently with pools of monoclonal antibodies, this method uses either indicator-labelled antibody or a labelled antispecies antibody (indirect). Usually, the label used is fluorescein. The indirect method is more sensitive, since more label can be bound to an infected cell. The most common use of this technique is for the diagnosis of respiratory viral infections, whereby a panel of reagents are utilised to detect RSV, parainfluenza virus, influenza A and B and adenovirus in multiple wells of a microscope slide. This technique is sensitive compared to cell culture, especially for detection of RSV. The ideal specimen for such testing is a nasopharyngeal aspirate, most usually obtained from infants with suspected bronchiolitis, for whom a rapid result is essential for correct clinical management and implementation of infection control measures. However, detection can also be made from a well-taken throat/nasal swab. There is increasing evidence that community or nosocomial acquired respiratory viruses lead to severe disease in immunocompromised patients (Flomenberg *et al.*, 1994; Apalsch *et al.*, 1995), and it is important that bronchoalveolar lavage specimens from such patients with respiratory disease are also tested for these viruses, in addition to the more common pathogens such as CMV. Respiratory virus antigens are expressed within the epithelial cells, and the success of the technique depends on an adequate collection of cells. A particular advantage of IF, compared to the commercial rapid antigen tests available for RSV and influenza, is that microscopic examination of the fixed cells can determine the presence of adequate cell numbers for analysis (Table 1.2).

IF has also been used widely for the direct detection of HSV and VZV in vesicle fluid, and has advantages over electron microscopy in both sensitivity and specificity.

Detection and semi-quantitation of CMV antigen-containing cells in blood can also be under-

Table 1.2 Antigen detection by immunofluorescence

Advantages	Disadvantages
Rapid Sensitive for some viruses (e.g. RSV)	Requires skilled staff Variable sensitivity Dependent on high-quality specimen

taken by direct IF. This technique involves separation of peripheral blood mononucleic cells (PBMCs) and fixing on a slide, following by staining with a monoclonal antibody directed against the matrix protein pp65. The frequency of positive cells can predict CMV disease in the immunocompromised patient (Van der Bij *et al.*, 1989), and is used in a number of laboratories. However, it is labour intensive, and requires a rapid processing of blood specimens if a reduction in sensitivity of detection is to be avoided (Boeckh *et al.*, 1994).

ELISA/Latex Agglutination

Solid phase systems for antigen detection are now used widely. ELISAs are based on the capture of antigen in a clinical specimen to a solid phase via a capture antibody, and subsequent detection using an enzyme linked specific antibody. Variation in capture and detector antibody species has increased the sensitivity of these assays, which are used for hepatitis B virus (HBV) surface antigen detection (HBsAg). HIV p24 antigen can also be quantitated in this way, although HIV RNA quantitation has now superseded this method in routine practice.

Small latex particles coated with specific antibody can be agglutinated in the presence of antigen, which can then be observed by the naked eye. This rapid assay is used for rotavirus diagnosis, with an equivalent sensitivity to electron microscopy. Capture of antibody, rather than antigen, can also be undertaken, although latex assays for CMV and VZV antibodies may lack sensitivity and specificity compared to ELISA systems (see below).

Electron Microscopy

Electron microscopy (EM) is the only technique available for visualizing directly viruses, and therefore has many applications beyond purely diagnostic purposes. The major role of EM in a clinical

Table 1.3 Electron microscopy

Advantages	Disadvantages
'Catch all' Economical running costs Detects unculturable viruses Adaptable, e.g. immunoelectron microscopy confirms cytopathic effect	Requires skilled staff Poor sensitivity Large capital outlay

setting is in the diagnosis of viral gastroenteritis, for which many of the aetiological agents are non-cultivable, and analysis of skin lesions for herpes, pox and papillomaviruses.

Preparation of specimens and the technique of negative staining are straightforward and quick, and the method is a 'catch all' approach to detecting viruses. Nevertheless, it has a limit of sensitivity of approximately 10^6 viral particles per millilitre of fluid. Vast numbers of virions are present during skin and gastrointestinal disease, and a diagnosis is easily made. This becomes more difficult later in the course of infection when viral shedding is reduced below the level of detection. Sensitivity can be enhanced by antibody-induced clumping of virus (immune EM) or ultracentrifugation; however, it is unrealistic to undertake these methods routinely.

The survival of EM within the routine clinical virology laboratory hinges on the availability of alternative, more sensitive methods of diagnosis. Many centres already use latex agglutination for rotavirus diagnosis, and polymerase chain reaction (PCR) is more sensitive for detection of herpesviruses in vesicular fluid (Beards *et al.*, 1998). Currently, EM in diagnostic virology laboratories is used primarily for outbreak investigation. Should an alternative method of small round structured virus diagnosis become available (Green *et al.*, 1995), then the future of EM in clinical virology will be put in doubt (Table 1.3).

Serology

All viral infections generate a humoral response, and this can be used for diagnostic purposes. The classical pattern of response following an acute infection is illustrated in Figure 1.1. The functional nature of this response is extremely variable. In some instances, these antibodies are neutralizing

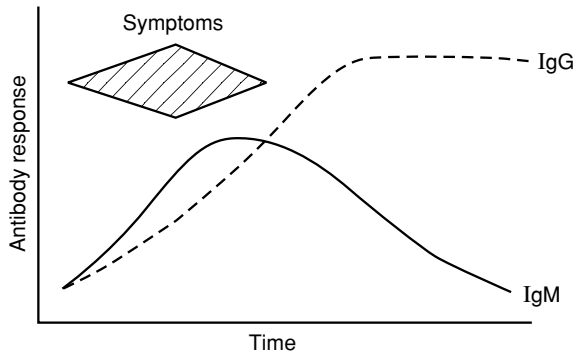

Figure 1.1 Typical evolution of antibody responses following an acute viral infection

and can be assessed for this activity (e.g. polioviruses). However, many infections are controlled more effectively by T cell responses, and antibody detection is used as a surrogate of infection. Traditionally, methods of antibody detection did not distinguish between IgG and IgM responses, and diagnosis was based on seroconversion or a significant rise in antibody titre between acute and

convalescent samples (10–14 days apart). The complement fixation test was used widely in this respect; however, assay insensitivity and the cross-reactivity of many antigens used within the assay limited its clinical usefulness. Most importantly, a diagnosis could only be made after the time of acute illness. Currently, the major use of this assay is for the diagnosis of ‘parabacterial’ pneumonia (*Chlamydia psittaci*, coxiella or mycoplasma), since there are few alternative serological methods. Other serological techniques include haemagglutination inhibition, latex agglutination and immunofluorescence (used most widely for EBV diagnosis).

Increasingly, solid phase enzyme-linked immunoassays are used in diagnostic laboratories. Many of these assays are available commercially, and can be automated. They are essentially of three types (Figure 1.2):

- *Indirect assays.* Viral antigen is immobilized on to a solid phase, specific antibody in the patient serum sample binds to this antigen, and after a washing step, this antibody is detected by an

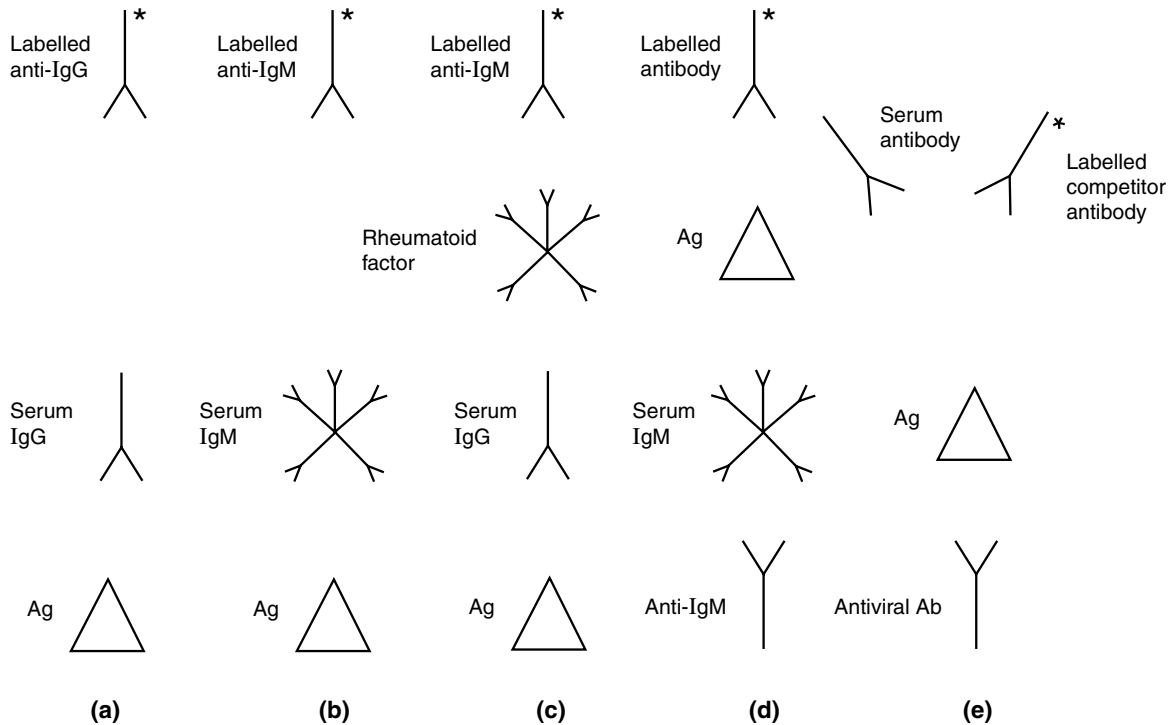

Figure 1.2 ELISA formats: (a) indirect IgG assay; (b) indirect IgM assay; (c) rheumatoid factor interference in IgM assay (indirect); (d) IgM capture assay; (e) competitive assay

Table 1.4 Serology

Advantages	Disadvantages
Specific IgG assays good indicator of prior infection	Retrospective (e.g. rising CFT titres) CFTs insensitive, especially to assess previous infection
Capture IgM assays good indicator of recent infection	Cross reactivity and interference
Allows retrospective diagnosis if no acute clinical specimen obtained	Insensitive for diagnosing some congenital infections (e.g. CMV)
Rapid	Not appropriate for immunocompromised
Automated	Spurious results possible following receipt of blood products
Diagnosis of unculturable or poorly culturable viruses	
Can utilize non-invasive clinical samples e.g. saliva, urine	

CFT = complement fixation test.

enzyme-labelled antihuman immunoglobulin. In this way, either specific IgG or IgM can be detected, depending on the indicator immunoglobulin (Figure 1.2a,b). Clearly, detection of IgM species is dependent on the prevailing level of IgG, such that a high level of specific IgG reduces the sensitivity of an IgM assay for the same virus. If rheumatoid factor is present in the clinical sample, it may lead to false-positive IgM results (Figure 1.2c).

- *Competitive assays.* In this case, a labelled antibody in the ELISA system competes for binding to immobilized antigen with antibody in the clinical sample. This assay improves both the specificity and sensitivity of the assay (Figure 1.2e).
- *Capture assays.* IgG or IgM species are captured on to the solid phase by antihuman immunoglobulin, followed by addition of antigen and then labelled antibody. With regard to IgM assays, this method reduces the potential interference of rheumatoid factor, and is used increasingly for a number of IgM species (Figure 1.2d).

Serological diagnosis of acute infection is best suited to situations in which detection of the virus itself is difficult, time-consuming or where virus excretion is likely to have ceased by the time of investigation, such as hepatitis A, rubella, parvovirus B19. There are situations, however, where IgM is produced over a prolonged period, or in response to reinfection, as is the case for rubella. In these cases, old infection can be distinguished from recent infection by antibody avidity tests. These are based on the principle that antibody responses mature over time, such that high avidity antibodies predominate at a later stage. By using a chaotropic agent (e.g. urea) during the ELISA washing stage, low affinity antibodies (representing recent infection) will be

preferentially dissociated from antigen, compared to higher affinity antibodies (Thomas and Morgan-Capner, 1991).

Immunoblot methods are used widely for confirmation of HIV and hepatitis C virus (HCV) infection. These methods are based on the detection of multiple epitopes blotted on to a membrane by antibodies within a serum sample. Non-specific reactions within ELISAs are often clarified in these systems, since possible cross reacting antibodies can be identified by non-viral antigenic epitopes.

Serology is also essential for diagnosis and screening of persistent infections where antibodies are detectable in the presence of virus replication, such as HIV and HCV. Finally, the availability of sensitive assays allows widespread screening for immunity against, for example, HBV, rubella, varicella zoster virus and hepatitis A.

Despite these more recent advances in serological techniques, there remain some inherent limitations with this form of virological diagnosis. It is highly dependent on the ability of the individual to mount appropriate immune responses to infection. Thus, serological methods have a limited role for diagnosing viral infections in the immunocompromised patient (Paya *et al.*, 1989) and every effort must be made to detect the virus itself. Transfusion or receipt of blood products may also lead to spurious serological results, for instance, leading to a false seroconversion. Since many transplant recipients also receive considerable levels of blood products, interpretation of serological results in such patients is even more difficult (Table 1.4). The major role of serology in these patients is in identifying immune status at baseline in order to ascribe a risk to primary infection, reinfection or reactivation during subsequent immunosuppression (Table 1.10).

NUCLEIC ACID DETECTION

A number of hybridization methods for detecting viral genome have been developed and used extensively since the 1980s. These are based on the hybridization of a labelled oligonucleotide probe to a unique complementary piece of viral genome, and can be undertaken either on a solid phase or *in situ*. These short probes are 20–30 bases in length and can be RNA (riboprobe) or DNA. Many solid phase assays are of the dot-blot or slot-blot type, and have been widely used for HPV diagnosis and typing. A more recent modification of probe assays is the branched DNA assay, whereby signal amplification increases the sensitivity of this methodology (see later).

However, the area of fastest development in diagnostic virology relates to molecular amplification assays to provide qualitative and quantitative results. PCR and other similar molecular assays have been applied to the diagnosis of virtually all human viruses. In general, the sensitivity of these assays far exceeds that of other virus detection systems, and subsequent interpretation of results in a clinical setting may be very difficult. These issues will be discussed following a brief review of the techniques available.

Polymerase Chain Reaction

This technique uses a thermostable DNA polymerase to extend primers complementary to the viral DNA genome target (Saiki *et al.*, 1988). Consecutive cycles of denaturation, annealing and extension result in an exponential accumulation of target DNA. This is limited only by substrate (nucleotide) availability and possible competition between target genome and non target amplicons for reaction components (Figure 1.3). RNA genomes require transcription to complementary DNA (reverse transcription) prior to the PCR reaction. Undertaking a second PCR round on the first round amplicon can increase the overall sensitivity of detection (nested PCR). This uses a different set of PCR primers internal to the first set, and therefore can act as a confirmation of the correct amplicon produced by the first round reaction.

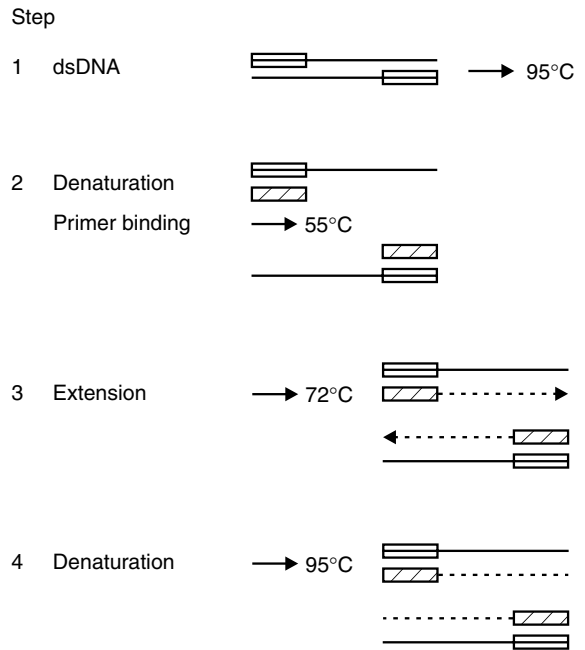

Figure 1.3 Polymerase chain reaction

Primers

The correct choice of primers is an important determinant of the success of any PCR. Clearly, the nucleic acid sequence of at least a part of the viral genome needs to be known, and primers must target a well-conserved region. This can be done using multiple alignment programs; however, the final success of the PCR depends on the availability of sequence data from a range of different viral isolates. Since unusual viral variants may not be detected by an established PCR technique, it is important for the clinical virologist to have knowledge of the primer targets in order to interpret results correctly. This issue is equally important for commercial assays as it is for 'in house' assays, as has recently been demonstrated regarding suboptimal HIV subtype detection by a commercial quantitative PCR assay (Arnold *et al.*, 1995). The appropriateness of primers also requires continual re-evaluation in the light of new selective pressures on viral evolution, such as antiviral drug resistance.

Other important aspects of primer design include the avoidance of secondary structure, or complementarity between primers (leading to so-called primer-dimer amplification artefacts). Computer programs used to design primer sequences address these aspects.

Preparation of Clinical Specimen

Viral gene detection methods do not require the maintenance of viral infectivity within the clinical specimen. Thus, specimens can be transported and stored in the fridge or freezer prior to analysis, with more flexibility than that required for virus isolation. This is a major advantage over traditional methods of virus detection. A particular concern is the susceptibility of RNA to nucleases, which are present in all biological material. Thus, specimens for qualitative and, especially, quantitative PCR require careful preparation. Currently, it is recommended that ethylenediaminetetraacetic acid (EDTA) blood for HIV RNA quantitation is separated as soon as possible, after which the plasma can be stored frozen until analysis. If multiple tests are to be undertaken on one sample, it should be aliquoted on receipt to avoid multiple freeze-thawing. A number of different nucleic acid extraction methods are available, and their use depends on the nature of the clinical specimen and whether the target is RNA or DNA.

Detection of Product

The PCR product of any specific reaction has a known size, and can therefore be detected on an agarose gel in comparison to a molecular weight ladder. However, more than one band may be seen, or the band position may not be in precisely the correct position. For this reason, specific detection of the product by hybridization with a nucleic acid probe is to be encouraged. This can be undertaken within a microtitre plate format, with a colorimetric end-point, and read in a standard spectrophotometer (e.g. Gor *et al.*, 1996). Many commercial PCR assays employ this system. The addition of such a step enhances further the specificity of the assay, and may also improve sensitivity. The limit of sensitivity for any one assay must be assessed. This can be undertaken by serial dilutions of a tissue culture of known median tissue culture infective dose (TCID₅₀), purified viral genome, tissue culture fluid with known virion concentration (by EM) or plasmid containing the target genome. Many laboratories are reluctant to introduce plasmids into the molecular biology area because of the risk of widespread contamination.

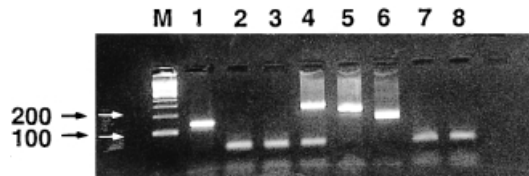

Figure 1.4 A 2% agarose gel of ethidium bromide-stained products from a multiplex PCR for HSV, VZV and CMV. Lanes: M, size markers (the 100 and 200 bp markers are indicated on the left); 1, isolate of HSV; 2, 3, 7 and 8 are negative specimens; 4, CMV control; 5, VZV control; 6, HSV control

Multiplex PCR

Since more than one viral target is often sought in one specimen, efforts have been made to combine multiple sets of primers, against different targets, within one PCR reaction (Jeffrey *et al.*, 1997). Each set of primers requires specific conditions for optimal amplification of the relevant target, and the development of a multiplex system requires a detailed evaluation of these conditions to ensure that the efficiency of amplification for any one target is not compromised. Identification of the specific product in this system may be based on different sized amplicons, or use of different probes. Figure 1.4 illustrates a multiplex PCR for HSV, VZV and CMV.

Quantitation

PCR is inherently a qualitative assay. Initial attempts to produce quantitative information involved the simultaneous analysis of samples with known target genome copy number, and comparing the intensity of bands on an agarose gel with that of the test specimen. However, the efficiency of amplification within any one PCR reaction is exquisitely sensitive to changes in condition, or indeed inhibitory factors within the clinical specimen. It is therefore important that internal standards (within the same PCR reaction) are used for quantitative assays. These control sequences should mimic the target genome as closely as possible, yet be detectable as a distinct entity on final analysis. This can involve the incorporation of restriction enzyme sites whereby the control amplicon, but not target sequence, can be cleaved subsequently (Fox *et al.*, 1992), or merely a control sequence of different size (Piatak *et al.*, 1993). Commercial assays often use a jumbled sequence as a control, with subsequent use

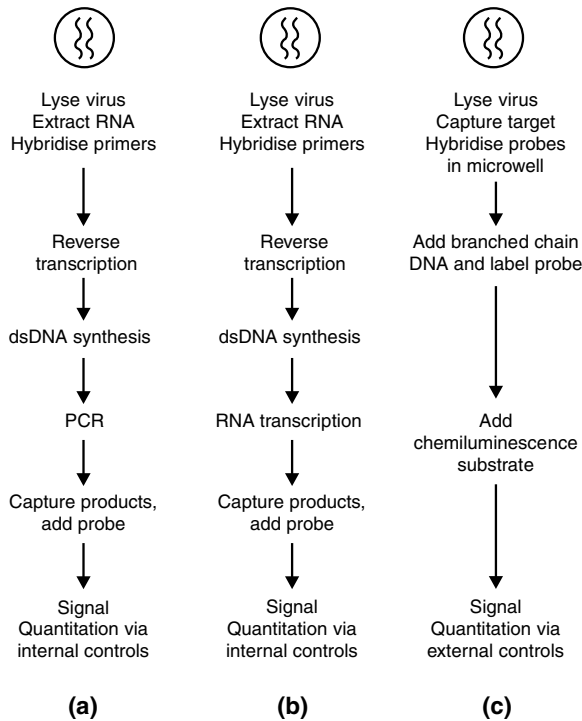

Figure 1.5 Quantitative molecular methods for HIV plasma RNA. (a) PCR; (b) NASBA; (c) bDNA

of probes against both control and target sequences. In all cases, since the number of control genomes is known, simple proportions can be applied to the signals to generate a quantitative value for the clinical specimen (Figure 1.5a).

These assays are inherently variable, due to both laboratory and biological variation. Many commercial assays are associated with a variation of 0.5 \log_{10} , and this must be considered in the clinical interpretation of results (Saag *et al.*, 1996). The dynamic range of these assays is determined by the linearity of the reaction. Variability is more likely at the extremes of this range, and this variability determines the lowest value (lower limit) at which the user can be confident that the value given approximates to the truth. The lower limit of sensitivity for quantitative HIV PCR can be increased by initial ultracentrifugation of plasma to concentrate virus.

Real-time PCR

The type of PCR reaction discussed above depends on end-point detection of product, with the aim of maximizing the amplification reaction. More sensi-

tive detection methods allow the kinetics of the amplification to be measured, and require fewer cycles of amplification for product to be detected.

Real-time PCR systems allow the reactions to be undertaken within a closed system, and fluorescence generated by the assay is measured without further manipulation. In the 'TaqMan' system, a specific probe binds to the relevant amplicon, and subsequent hydrolysis of this probe produces an increase in fluorescence (Morris *et al.*, 1996). The 'LightCycler' system allows product detection by the incorporation of an intercalating dye into double stranded DNA, with an increase in fluorescence as product accumulates (Wittwer *et al.*, 1997). Specificity of this reaction for the correct product (rather than artefacts) is provided by analysing a decrease in fluorescence at the melting temperature specific for that product. A number of probe systems are also available to generate sequence-specific fluorescence signals. These systems are also suitable for quantitative PCR, based on the number of temperature cycles required for a threshold fluorescence signal to be reached.

These systems produce very rapid temperature cycling times, and therefore PCR reactions can be completed within minutes. It is likely that real-time PCR will prove highly suitable to the diagnostic virology laboratory in future.

PCR Contamination and Control Reactions

PCR is highly susceptible to contamination from amplified products generated in a previous reaction, from target sequences cloned in plasmid vectors and from other positive clinical specimens. By contrast, a false negative result can arise from inadequate nucleic acid extraction from a sample, and inhibitory factors in the PCR reaction. Similarly, the sensitivity of the assay may be reduced but not completely inhibited. Relevant controls within each PCR run are essential for a correct interpretation of a positive or negative result, and these are highlighted in Table 1.5.

There are two specific procedures designed to reduce PCR contamination. Firstly, extraneous DNA within PCR reagents can be inactivated by subjecting 'clean' PCR reagents to ultraviolet irradiation. This introduces thymidine dimers into the DNA chain, rendering it unamplifiable. More effective is the use of uracil-*N*-glycosylase (UNG) in the PCR reaction (Longo *et al.*, 1990). Thus, uracil

Table 1.5 PCR—recommended controls

<i>Negative Controls</i>	
• Extraction control	—to control for contamination during extraction —mimic clinical sample
• Reagent control	—to control for contamination of reagents —use solvent in which extracted nucleic acid is suspended
<i>Positive controls</i>	
• Extraction control	—use positive clinical specimen
• Control genome	—to control for PCR efficiency, specifically to assess sensitivity
• Alternate target	—to control for inhibition of reaction

rather than thymidine is incorporated into the PCR product. This does not affect specific product detection, however, incorporation of UNG into new PCR reactions within the laboratory will lead to cleavage of contaminating uracil containing DNA fragments.

Physical Organization of the Laboratory

The physical requirements for undertaking ‘in-house’ PCR reactions are demanding (Victor *et al.*, 1993). A ‘clean room’ is required in which preparation and aliquoting of reagents occurs. This must be isolated from any possible contamination with viral nucleic acid. A separate area is also required for nucleic acid extraction, although this can be undertaken in a diagnostic area. A dedicated PCR room is required for setting up reactions and siting of thermal cyclers. Finally, another room is required for post-PCR analysis, such as gel running and genome detection. Dedicated laboratory coats and equipment are required for each of these areas, and strict adherence to protocol by all staff is essential (Table 1.6).

Clearly, the provision of such a dedicated set of rooms for molecular biology is a challenge for busy diagnostic virology laboratories. Nevertheless, it is paramount that diagnostic PCR reactions are undertaken with minimal risk of contamination, and every effort must be made to provide the relevant space if such assays are to enter the routine diagnostic armamentarium. Some of the newer automated commercial assays incorporate some of the above steps within a self contained machine, however, it is unwise to use such assays outside of a molecular biology environment in which staff are well trained in this type of work.

Table 1.6 PCR—physical separation

1. Preparation of reagents
 - ‘clean’ room (no nucleic acid)
 - separate room
2. Nucleic acid extraction.
3. Amplification reactions (in cases of nested reactions, second round PCR should be further separated)
4. PCR product analysis

Quality control

Molecular biology is expensive compared to more traditional virological methods, making it difficult for each laboratory to undertake comprehensive evaluations of each PCR assay. For this reason, there is an urgent requirement for standardized methodologies, and, at least in this respect, the availability of commercial assays is welcome. There is also a need for external quality control schemes, since major clinical and therapeutic decisions are made on the basis of molecular assay results, many of which have been developed ‘in house’.

Other amplification systems

Nucleic Acid Sequence-Based Amplification (NASBA)

This technique uses RNA as a target, utilising three enzyme activities simultaneously: reverse transcriptase (RT), RNase H, and a DNA-dependent RNA polymerase (Guatelli *et al.*, 1990). A primer incorporating the T7 promoter hybridizes to the target RNA and is extended by reverse transcriptase. RNase degrades the RNA strand and the RT utilizing a second primer produces double-stranded DNA. T7 polymerase then forms multiple copies of RNA from this DNA template. This method is suited to the detection of RNA viruses, or mRNA transcripts of DNA viruses. In addition, it can be modified to a quantitative assay using internal controls (Figure 1.5b).

Ligase Chain Reaction (LCR)

The ligase chain reaction involves hybridization of two oligonucleotide probes at adjacent positions to complementary strands of target DNA. These are joined subsequently by a thermostable ligase, and multiple rounds of denaturation, annealing and

ligation lead to an exponential amplification of the viral DNA target (Hsuih *et al.*, 1996). RNA targets require prior reverse transcription.

Branched chain DNA (bDNA)

This method uses a signal amplification system rather than amplifying target genome. Single stranded genome (RNA or DNA) is hybridized to an assortment of hybrid probes, which are captured in turn onto a solid phase by further complementary sequences. Branched DNA amplifier molecules then mediate signal amplification via enzyme-labeled probes with a chemiluminescent output. This method can also provide quantitative results (Dewar *et al.*, 1994) (Figure 1.5c).

CLINICAL USE OF MOLECULAR TECHNIQUES

The application of qualitative and quantitative molecular analysis to human viral infections has provided new insights into the natural history of human viral infections, such as HIV, HBV, HCV and the herpesviruses. This includes the nature of viral persistence and latency, viral replication and turnover rate, and an understanding of the response to antiviral therapies. It follows that molecular diagnostic assays do not merely offer an increase in sensitivity over alternative methods—rather, their correct interpretation demands an understanding of our transformed knowledge. These issues are discussed further below (Table 1.7).

Table 1.7 Clinical use of molecular amplification techniques

- Diagnosis of infection
- Diagnosis of disease
- Prediction of disease/staging of infection
- Monitoring antiviral therapy
- Prediction of transmission
- Confirming transmission events
- Epidemiology of infection

Diagnosis of Infection

Infection is defined by the presence of virus in a clinical specimen. The infection may be asymptomatic or symptomatic (disease), however the key determinant for correct diagnosis is the sensitivity of the assay, with a goal of detecting viral genome if it is present at any level. A qualitative assay is relevant, for instance, in the diagnosis of HIV in infants (proviral DNA in PBMCs) (*Morbidity and Mortality Weekly Report*, 1998a) or HCV (serum RNA) infection (Zeuzen *et al.*, 1994). Before introducing such an assay into routine use, the sensitivity and specificity of the new test must be established, according to the formulae in Table 1.8. Note that in this instance, these parameters are compared to an existing gold standard assay, (true positives or negatives) and therefore relate purely to a comparison between assays. Since molecular assays are usually more sensitive than existing assays, it is often necessary to confirm that those samples positive solely by the molecular assay are indeed true positives. This can be done by confirming the identity of the PCR product, correlation with another marker of infection (for instance, seropositivity,

Table 1.8 Evaluation of a new diagnostic assay

Parameter	Description	Formula
Sensitivity	Proportion of true positives correctly identified by test	$\frac{\text{positive results}}{\text{true positives}}$
Specificity	Proportion of true negatives correctly identified by test	$\frac{\text{negative results}}{\text{true negatives}}$
Positive predictive value	Proportion of patients with positive test results who are correctly diagnosed	$\frac{\text{sensitivity} \times \text{prevalence}}{\text{sensitive} \times \text{prevalence} + (1 - \text{specificity}) \times (1 - \text{prevalence})}$
Negative predictive value	Proportion of patients with negative test results who are correctly diagnosed	$\frac{\text{specificity} \times (1 - \text{prevalence})}{(1 - \text{sensitivity}) \times \text{prevalence} + \text{specificity} \times (1 - \text{prevalence})}$

where appropriate) or the clinical background. Thus, an expanded gold standard, including positives by both existing and new assay, is used for sensitivity and specificity calculations.

Diagnosis of Disease

As discussed above, the nature of viral disease has had to be redefined in the light of qualitative and quantitative molecular data. Increasingly, it is possible to detect the presence of infectious agents at low copy number, in the absence of symptoms. This makes the interpretation of positive results problematic, and requires close clinical–virological liaison. Three approaches are possible:

1. **Qualitative detection of viral genome at a site which is normally virus free.** A good example is the diagnosis of viral encephalitis, in which detection of HSV, CMV, VZV or enterovirus genome is diagnostic (Jeffrey *et al.*, 1997). Indeed, it has been very difficult traditionally to propagate herpesviruses in cell culture from cerebrospinal fluid (CSF) samples. It is unclear whether this is a reflection of a low level of virus, or whether there is a preponderance of disrupted, non-infectious virus produced from brain tissue into the CSF.
2. **Qualitative detection of virus without an exquisite level of sensitivity.** This is important for instances in which low-level viraemia may occur in the absence of disease, and which does not predict disease. An example is CMV infection following transplantation. The sensitivity of a diagnostic qualitative PCR must be chosen with care in order that results are predictive of disease (Figure 1.6).
3. **Quantitative detection of virus at a level associated with disease.** For many persistent virus infections with transient or continual low level viraemia, the onset of disease is related to a higher viral replication rate. This provides the rationale to identify levels of viraemia, which are predictive of disease. HHV-6 and HHV7 infections can be used as examples. These herpesviruses are acquired commonly in early childhood, and primary infections are associated with erythema infectiosum and febrile seizures in a small proportion of infants, with the majority of infections remaining asymptomatic (Hall *et al.*,

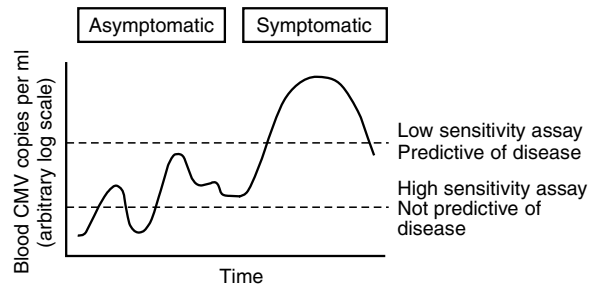

Figure 1.6 The relevance of PCR sensitivity for CMV diagnosis following transplantation. A very sensitive assay for detection of persistent/latent viruses, such as CMV, may not provide clinically useful information. This is because low levels of viraemia may occur without causing disease. With regard to CMV, the threshold for detection of virus in whole blood should have a high level

1994). These persistent infections can be detected by PCR in saliva and blood of many seropositive individuals, so that a qualitative PCR is not helpful in diagnosis of symptoms specifically associated with these infections. By contrast, application of a quantitative PCR to such clinical specimens demonstrates that febrile seizures are specifically associated with higher systemic viral loads (Clark *et al.*, 1997). Quantitative molecular and antigenaemia data on CMV disease in transplant patients (Boeckh *et al.*, 1996) and those with the acquired immune deficiency syndrome (AIDS) (Spector *et al.*, 1998) also demonstrates the usefulness of this approach. Clear diagnostic definitions of diseases will depend on the assay itself and the patient group concerned. Large prospective studies are therefore required in each case. Standardization within commercial assay systems will help in this respect.

Prediction of Disease/Staging of Infection

Pre-emptive therapy entails the initiation of therapy in those at highest risk of disease, and is an approach which is used commonly for CMV infection in bone marrow and solid organ recipients. The capacity of a positive laboratory test to predict disease must be established by detailed prospective surveillance protocols, in order to generate positive, and negative predictive values (Table 1.8). Since the natural history of viral infections (relationship be-

tween replication and disease) may be influenced by factors such as the length and nature of immunosuppression, these parameters should be determined separately for different patient groups, such as bone marrow recipients, solid organ recipients and patients with AIDS.

A similar approach has now been established for HIV infection. The large Multicentre AIDS Cohort Study (MACS) demonstrated clearly a relationship between plasma HIV RNA load and risk of disease progression. In this analysis, CD4 cell count was also an independent predictor, and both measurements together provided the best prognostic indicator (Mellors *et al.*, 1997). Subsequently, this prognostic capability has been transformed into guidelines for initiating antiviral therapy (see next section). A similar analysis of HCV viral load has been undertaken (Gretch *et al.*, 1994). A detailed understanding of the virological natural history of HBV using sensitive quantitative molecular assays is required before prognostic criteria can be applied to this infection.

Use of Molecular Assay to Monitor Antiviral Therapy

The decision on when to initiate therapy for HIV disease is complex. Recent guidelines (*Morbidity and Mortality Weekly Report*, 1998b) suggest that therapy should be considered when the plasma HIV RNA is above 10 000 copies ml⁻¹. Of note, this recommended level is reduced to 5000 if the bDNA assay available currently is used, in recognition of the different assay dynamics at low copy number.

The relationship of HIV RNA quantitation to prognosis supports the thesis that the 'disease activity' is reflected in overall viral replication rate. It follows that antiviral induced reduction in plasma RNA is likely to translate into clinical benefit. This has now been confirmed in a number of clinical trials. For example, a virological analysis of the AIDS Clinical Trial Group (ACTG) 241 trial (zidovudine, 3TC with/without nevirapine) showed that for each 1 log₁₀ reduction of HIV RNA between baseline and week 8, there was an incremental reduction in clinical progression of death at week 48 (Hughes *et al.*, 1997). This is important information, since it provides more confidence in using viral load measurements for short term trials

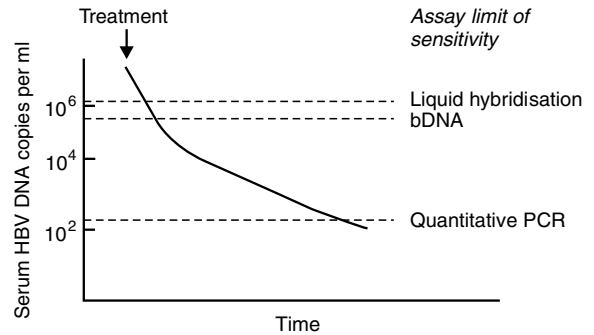

Figure 1.7 Quantitative assays for HBV: their relevance in assessing response to antiviral drugs. A relatively modest reduction in HBV viral load in response to therapy is required in order for HBV DNA levels to become undetectable by an insensitive assay. Important information on the rate and extent of viral suppression is missed by the liquid hybridization assay

of antiviral agents.

The virological goal of HIV therapy is to reduce HIV RNA to undetectable levels, and optimal therapy should achieve this by 12 weeks following initiation of therapy. Current protocols recommend subsequent tests at 2–3 month intervals to monitor the success of therapy (*Morbidity and Mortality Weekly Report*, 1998b). Commercially available assays have a limit of sensitivity of around 400 copies ml⁻¹. Subsequent generations of these assays have a 50 copies ml⁻¹ limit, and clinical trial data suggest that reduction of viral load to below this level predicts durability of antiviral response (Montaner *et al.*, 1998).

Quantitation of serum HBV DNA has been an important tool in determining when to initiate interferon therapy, and to assess response. This has usually been undertaken by a liquid hybridization assay, with results expressed as pg ml⁻¹. More recently, nucleoside analogues (lamivudine, famciclovir) and nucleotide analogues (adefovir) have demonstrated potent anti-HBV activity (e.g. Lai *et al.*, 1998). Using more sensitive quantitative assays, such as bDNA or PCR, 2–3 log reductions in HBV viral load have been observed (defined as copies ml⁻¹). In view of the relative insensitivity of the hybridization assay (approximately 10⁶ copies ml⁻¹), these new assays can provide important information on the potency of drugs and dynamics of response (Figure 1.7). Prior to their introduction as routine tests, clinicians and virologists alike must appreciate fully the meaning of changes and abso-

lute levels of viral load.

With regard to HCV, a high pretreatment viral load predicts poor response to interferon therapy, and such individuals are more likely to respond to interferon/ribavirin combination (Reichard *et al.*, 1998). Following therapy, a rapid loss of viraemia predicts longer-term success. However, the role of quantitative PCR for monitoring therapy requires further clarification. Of note, HCV response to current antiviral drugs is also partially dependent on viral genotype, and there is an increasing requirement for diagnostic laboratories to provide such assays.

Virological monitoring of patients receiving anti-CMV therapy is important. Not only does a high viral load predict CMV disease, but persistent viraemia following onset of therapy, or virological relapse on therapy is associated with continuing disease. Conversely, in bone marrow transplant recipients treated with ganciclovir pre-emptively, clearance of viraemia can be used as a guide to stop therapy (Einsele *et al.*, 1995). As for HBV and HCV, more standardization of assays and validation in different patient groups is required before quantitative CMV assays are routinely applied.

In all cases of antiviral drug monitoring using qualitative or quantitative molecular assays, a rebound in viral load or failure to suppress viral replication may reflect reduced drug susceptibility. In these cases, it may be appropriate to undertake drug susceptibility assays, and these are described later.

One of the interesting aspects to emerge from the measurement of viral load responses to antiviral therapy is an understanding of the turnover and compartmentalization of viral infections with a persistent viraemic phase. A detailed and longitudinal study of viral load changes under therapy allows calculation of viral production kinetics. Such analysis demonstrates more than one slope of viral load decline (in a log scale) for HIV (Perelson *et al.*, 1997), HBV (Burroughs *et al.*, 1998), HCV (Zeuzen *et al.*, 1994) and CMV (Payan *et al.*, 1996). This suggests a differential antiviral activity on the total viral population and may also reflect different turnover rates for infected cell types. Thus, the initial three slopes of HIV decline following potent therapy are thought to reflect turnover of HIV-infected activated CD4 cells, turnover of infected macrophages and turnover of latently infected CD4 cells. For HBV, the first slope represents reduction in

production from infected hepatocytes, and the second slope probably represents turnover of virus containing hepatocytes. The importance of these studies is in identifying strategies for long term suppression or even eradication of infection.

Prediction of Transmission

It is reasonable to assume that a high viral load within an individual will predict transmission to another, although this is difficult to demonstrate in practice. Studies on vertical HIV transmission suggest that the mother's viral load is a better indicator of vertical transmission than CD4 cell count (O'Shea *et al.*, 1998). Similarly, in a study of 155 HIV and HCV coinfecting women, the maternal plasma HCV RNA was significantly higher in those who transmitted HCV to their offspring compared to those who did not (Thomas *et al.*, 1998). The availability of quantitative assays allows similar studies to be undertaken with other viruses.

Use of Viral Genetic Analysis for Transmission Events and Epidemiology

Viral genome sequencing is now a standard method for establishing transmission events. This uses the nature of viral quasispecies, in that genetic relatedness between viruses is sought against a background of variation. In such investigations, the choice of gene targets to amplify and sequence is important, and results must be subject to the correct statistical and phylogenetic analysis if strong evidence for a transmission event is to be demonstrated. This approach is particularly important in the investigation of health care workers infected with blood-borne viruses, such as HBV (Zuckerman *et al.*, 1995; Ngui and Teo, 1997) and HIV (Blanchard *et al.*, 1998).

Sequence relatedness between different virus isolates is also essential for virus classification. The data used to generate phylogenetic trees is usually derived from conserved genes, such as those coding for viral enzymes or structural proteins. This type of analysis has been used recently to develop a classification of small round structured viruses (Clarke and Lambden, 1997).

Table 1.9 Advantages and disadvantages of phenotypic and genotypic antiviral drug resistance assays

	Advantages	Disadvantages
<i>Phenotype</i>	Represents sum of all mutations Quantitative assessment of resistance (IC_{50} , IC_{95}) Can assess cross-resistance	Expensive Labour intensive Slow Selection of culture adapted strains (not with recombinant virus assay)
<i>Genotype</i>		
(a) Selective (e.g. point mutation assay, line probe)	Quick Relatively inexpensive (PMA) Semiquantitation (PMA)	Difficult to interpret single mutation in absence of other information
(b) sequencing	Rapid Comprehensive information Background polymorphisms detected	Expensive Labour intensive Expertise in genomic analysis required Simultaneous mutations not necessarily on same genome

ANTIVIRAL DRUG RESISTANCE

Resistance has been documented to virtually all compounds with antiviral activity, and the emergence of antiviral resistance in clinical practice should come as no surprise. Drug susceptibility is a biological concept, and defined by the concentration of drug required to inhibit viral replication. Thus, drug resistance is not 'all or none' but rather a quantitative measure. The genetic basis of this resistance is becoming well understood, and thus specific viral genetic mutations are associated with resistance.

As the use of these drugs increases, there will be increasing pressure on diagnostic laboratories to provide assays to determine the cause of drug failure, of which drug resistance is one. Laboratory assays for drug resistance fall into two major categories: phenotypic and genotype assays. Their relative advantages and disadvantages are summarized in Table 1.9.

Phenotypic Assays

The plaque reduction assay (PRA) is used widely for herpesviruses and remains the gold standard for detecting HSV, CMV and VZV drug resistance. In essence, a specific titre (plaque forming units) of

virus is inoculated on to a permissive cell monolayer, usually within a multiwell plate. These monolayers are overlaid with increasing concentrations of drug in a semisolid medium, thus preventing extracellular virus spread. The plaque reduction associated with drug inhibition can then be calculated, with results expressed as IC_{50} or IC_{90} (concentrations of drug required to inhibit virus production by 50% and 90%, respectively). Alternative methods for HSV include the dye uptake method which quantitates viable cells within a viral infected monolayer. The time consuming nature of VZV and CMV culture techniques has led to the development of rapid culture methods, using viral antigen detection or genome detection to assess drug efficacy (Pepin *et al.*, 1992). All these assays produce different IC_{50} values on the same isolates, and standardization is therefore required.

Plaque assays have also been developed for HIV, making use of a CD4 expressing HeLa cell line (Chesebro and Wehrly, 1988). This assay is easy to use, but is limited to syncytium-inducing isolates, and cannot be used to assess protease inhibitor activity. The most standardized of HIV susceptibility assays uses peripheral blood mononuclear cells in which to grow the isolate in question, in the presence of drug. The end-point in this primary cell assay is p24 production (Hollinger *et al.*, 1992). However, this is a very labour intensive assay which is impractical for routine clinical use. A more inter-

esting development in the area of HIV susceptibility assays is the recombinant virus assay, whereby PCR product amplified directly from plasma virus is recombined with an HIV clone lacking the relevant gene (Hertogs *et al.*, 1998). These fragments can include the reverse transcriptase gene, protease gene, and gag cleavage sites, and the resulting recombinant can then be screened for susceptibility to a range of drugs. Since the background clone of virus used grows rapidly in culture, this method is more rapid than conventional phenotypic assays, and holds much promise for the future.

Phenotypic assays are clearly important, since they reflect global determinants of drug resistance. A criticism is that they require propagation of a virus stock before the assay is undertaken. This process is selective itself, and may lead to the final susceptibility assay being carried out on an unrepresentative species. This problem does not relate to recombinant assay, however, selection may still occur within the PCR amplification step.

Genotypic Assays

An understanding of the genetic basis of drug resistance, and the availability of automated and non-radioactive methods of nucleic acid sequencing have enabled widespread assessment of clinical isolates with reduced viral susceptibility. These methods are used most commonly for HIV drug resistance, and will become important for poorly cultivatable viruses such as HBV and HCV. Genotypic assays for drug resistance in CMV have also been developed recently.

Detection of Individual Mutations

A number of groups have described selective PCR or point mutation assays (PMAs) for HIV, HBV and CMV resistance associated mutations. In the selective PCR assays, PCR primers are synthesized that selectively hybridize to a wild type or mutant target (Kozal *et al.*, 1993). The PMA is based on the specific detection (radioactivity or colorimetry) of one of four bases extending the 3' end of a primer, complementary to the wild type or mutant sequence (Kaye *et al.*, 1992). One particular advantage of the PMA is the ability to detect mixtures of genotypes within a viral population with a sensitivity of less

than 10%. These assays are most appropriate when the mutation in question is clearly associated with resistance, such as the detection of lamivudine-resistance mutations in HBV by a real-time PCR method (Cane *et al.*, 1999). Since multiple mutations may be associated with resistance, especially in the context of combination therapy for HIV, the implications of a single mutation may change, making interpretation of a PMA difficult. To some extent this can be overcome by the application of a range of PMAs to one PCR product.

Line Probe Assays

These assays are available commercially for HIV mutations. A reverse transcriptase-PCR (RT-PCR) product is hybridized to multiple probes attached along a solid phase strip. The visual signal generated by such hybridization allows a range of possible mutations to be detected and compared with a standard (Stuyver *et al.*, 1997). Problems with this assay include a lack of signal due to viral genome polymorphism in the hybridization region. In addition, strips need almost constant updating in order to detect mutations conferring resistance to new drug combinations.

Restriction Fragment Length Polymorphism (RFLP) Assays

Based on the common ganciclovir resistance mutations within the UL97 (kinase) gene of CMV, a system has been devised involving two PCR reactions and restriction digests of the products to detect one or more of these mutations from clinical isolates. This system detects some 70% of currently recognized UL97 mutations, and can function as a useful screening assay (Chou *et al.*, 1995).

Nucleic Acid Sequencing

Recent advances in automated sequencing and gene chip technology (based on specific hybridization to PCR-amplified product of thousands of oligonucleotides on a microchip) (Kozal *et al.*, 1996) allow complex data from the viral gene or genes of interest to be accumulated. When based on PCR-amplified product from the plasma, as they usually are, these techniques provide information only on the majority population within the quasispecies and cannot identify specific linkages between two or more

Table 1.10 A typical protocol for virological monitoring of transplant recipients

Pretransplant	Donor serology:	HIVAb, HCVAb, HBSAg, HbcoreAb, CMVAb, EBVAb.	
	Recipient serology:	HIVAb, HCVAb, HBSAg, HBcoreAb, CMVAb, EVBAb, HSVAb, VZVAb.	
Posttransplant	Weekly surveillance (3 months): CMV viraemia (PCR, antigenaemia)		
<i>Symptoms</i>	<i>Specimens</i>	<i>Possible causes</i>	<i>Techniques</i>
Respiratory	Throat swab	CMV, HSV, influenza	Virus isolate
	BAL	RSV, parainfluenza	Immunofluorescence
	Blood (CMV)	Adenovirus	PCR
Gastrointestinal	Biopsy, stool,	CMV, HSV	Virus isolation
	Blood (CMV)	Adenovirus	PCR and EM
		Rotavirus (rare)	
CNS	CSF	CMV, JC (rare)	PCR
	Blood (CMV)		
Urinary tract (haemorrhagic cystitis)	Urine	Adenovirus, BK	PCR, EM

BAL, bronchoalveolar lavage.

Risk factors for specific viruses differ between transplant groups.

Significance of CMV viraemia during routine surveillance depends on nature of prophylaxis given.

mutations—that is, they cannot exclude different mutations existing on separate genomes. Despite the cost of these techniques, and the software and expertise required for data analysis, they are currently being introduced into routine practice for HIV drug resistance testing.

RECOMMENDED INVESTIGATIONS

It is the role of the clinical virologist to decide on the most appropriate investigations for any given clinical scenario. In the light of assay developments and identification of new viruses, clinical protocols require constant updating. There is an increasing emphasis on direct and rapid detection of viral causes of disease, in contrast to retrospective serological diagnosis, and this is to be encouraged. Not only is this important for clinical management, but it also leads to a higher rate of positive identifications.

Thus, wherever possible, the relevant clinical specimen should be requested. Laboratory request forms are important in this respect, and should encourage documentation of full clinical details. The practice of sending a serum sample to the virology laboratory accompanying a request for a 'screen' should be strongly discouraged.

A special emphasis on the immunocompromised

patient population is required, since they may experience life-threatening viral infections, which may present atypically. Ongoing antiviral prophylactic therapy may also distort the nature and timing of presentation. Table 1.10 highlights a typical set of protocols for the monitoring of transplant recipients. Precise protocols will depend on the patient group concerned, availability of laboratory facilities and, of course, budgetary constraints. Nevertheless, in the context of high risk patients, such as those receiving long-term chemotherapy or transplants, the overall cost of virological investigations will be relatively small.

REFERENCES

- Apalsch, A.M., Green, M., Ledesma-Medina, J. *et al.* (1995) Parainfluenza and influenza virus infections in pediatric organ transplant recipients. *Clinical Infectious Diseases*, **20**, 394–399.
- Arnold, C., Barlow, K.L., Kaye, S. *et al.* (1995) HIV type 1 sequence subtype G transmission from mother to infant: failure of variant sequence species to amplify in the Roche Amplicor Test. *AIDS Research and Human Retroviruses*, **11**, 999–1001.
- Beards, G., Graham, C. and Pillay, D. (1998) Investigation of vesicular rashes for HSV and VZV by PCR. *Journal of Medical Virology*, **54**, 155–157.
- Blanchard, A., Ferris, S., Chamaret, S. *et al.* (1998) Molecular evidence for nosocomial transmission of human immunodeficiency virus from a surgeon to one of his patients. *Journal of*

- Virology*, **72**, 4537–4540.
- Boeckh, M., Woogerd, P.M., Stevens-Ayers, T. *et al.* (1994) Factors influencing detection of quantitative cytomegalovirus antigenemia. *Journal of Clinical Microbiology*, **32**, 832–834.
- Boeckh, M., Gooley, T.A., Myerson, D. *et al.* (1996) Cytomegalovirus pp65 Antigenemia-guided early treatment with ganciclovir at engraftment after allogeneic marrow transplantation: a randomised double-blind study. *Blood*, **88**, 4063–4071.
- Burroughs, N.J., Rand, D.A., Pillay, D. *et al.* (1998) The consequences of quasispecies heterogeneity and within-host ecology for antiviral therapy in HBV. In *Therapies for Viral Hepatitis* (eds R.F. Schinazi, J.-P. Sommadossi and H.C. Thomas), pp. 335–343. International Medical Press, London.
- Cane, P.A., Cook, P., Ratcliffe, D., *et al.* (1999) Use of real-time PCR and fluorimetry to detect lamivudine resistance-associated mutations in Hepatitis B virus. *Antimicrobial Agents and Chemotherapy*, **43**(7), 1600–1608.
- Chesebro, B. and Wehrly, K. (1988) Development of a sensitive quantitative focal assay for human immunodeficiency virus infectivity. *Journal of Virology*, **62**, 3779–3788.
- Chou, S., Guentzel, S., Michels, K.R. *et al.* (1995) Frequency of UL97 phosphotransferase mutations related to ganciclovir resistance in clinical cytomegalovirus isolates. *Journal of Infectious Diseases*, **172**, 239–242.
- Clark, D.A., Kidd, I.M., Collingham, K.E. *et al.* (1997) Diagnosis of primary human herpesvirus 6 and 7 infections in febrile infants by polymerase chain reaction. *Archives of Disease in Childhood*, **77**, 42–45.
- Clarke, I.N. and Lambden, P.R. (1997) The molecular biology of caliciviruses. *Journal of General Virology*, **78**, 291–301.
- Dewar R.L., Highbarger, H.C., Sarmiento, M.D. *et al.* (1994) Application of branched DNA signal amplification to monitor human immunodeficiency virus type 1 burden in human plasma. *Journal of Infectious Diseases*, **170**, 1172–1179.
- Einsle, H., Ehninger, G., Hebart, H. *et al.* (1995) Polymerase chain reaction monitoring reduces the incidence of cytomegalovirus disease and the duration and side effects of antiviral therapy after bone marrow transplantation. *Blood*, **86**, 2815–2820.
- Flomenberg, P., Babbitt, J., Drobyski, W.R. *et al.* (1994) Increasing incidence of adenovirus disease in bone marrow transplant recipients. *Journal of Infectious Diseases*, **169**, 775–781.
- Fox, J.C., Griffiths, P.D. and Emery, V.C. (1992) Quantification of human cytomegalovirus DNA using the polymerase chain reaction. *Journal of General Virology*, **73**, 2405–2408.
- Gor, D., Lee, D. and Emery, V.C. (1996) Detection of human cytomegalovirus polymerase chain reaction products using oligonucleotide probes directly conjugated to alkaline phosphatase. *Journal of Virological Methods*, **61**, 145–150.
- Green, J., Gallimore, C.I., Norcott, J.P. *et al.* (1995) Broadly reactive reverse transcriptase polymerase chain reaction for the diagnosis of SRSV-associated gastroenteritis. *Journal of Medical Virology*, **47**, 392–398.
- Gretch, D., Corey, L., Wilson, J. *et al.* (1994) Assessment of hepatitis C virus RNA levels by quantitative RNA polymerase chain reaction: high-titer viremia correlates with advanced stage of disease. *Journal of Infectious Diseases*, **169**, 1219–1225.
- Guatelli, J.C., Whitfield, K.M., Kwoh, D.Y. *et al.* (1990) Isothermal, *in vitro* amplification of nucleic acids by a multienzyme reaction modeled after retroviral replication. *Proceedings of the National Academy of Sciences of the USA*, **87**, 1874–1878.
- Hall, C.B., Long, C., Schnabel, K.C. *et al.* (1994) Human herpesvirus-6 infection in children. A prospective study of complications and reactivation. *New England Journal of Medicine*, **331**, 432–438.
- Hertogs, K., de Bethune, M.P., Miller, V. *et al.* (1998) A rapid method for simultaneous detection of phenotypic resistance to inhibitors of protease and reverse transcriptase in recombinant human immunodeficiency virus type 1 isolates from patients treated with antiretroviral drugs. *Antimicrobial Agents and Chemotherapy*, **42**, 269–276.
- Hollinger, F., Bremer, J., Myers, L. *et al.* (1992) Standardisation of sensitive human immunodeficiency virus coculture procedures and establishment of a multicentre quality assurance program for the AIDS clinical trials group. *Journal of Clinical Microbiology*, **30**, 1787–1794.
- Hsuih, T.C., Park, Y.N., Zaretsky, C. *et al.* (1996) Novel, ligation-dependent PCR assay for detection of hepatitis C in serum. *Journal of Clinical Microbiology*, **34**, 501–507.
- Hughes, M.D., Johnson, V.A., Hirsch, M.S. *et al.* (1997) Monitoring plasma HIV-1 RNA levels in addition to CD4⁺. *Annals of Internal Medicine*, **126**, 929–938.
- Jeffrey, K.J., Read, S.J., Peto, T.E. *et al.* (1997) Diagnosis of viral infections of the central nervous system: clinical interpretation of PCR results. *Lancet*, **349**, 313–317.
- Kaye, S., Loveday, C. and Tedder, R.S. (1992) A microtitre format point mutation assay: application to the detection of drug resistance in human immunodeficiency virus type 1 infected patients treated with zidovudine. *Journal of Medical Virology*, **37**, 241–246.
- Kozal, M.J., Shafer, R.W., Winters, M.A. *et al.* (1993) A mutation in human immunodeficiency virus reverse transcriptase and decline in CD4 lymphocyte numbers in long-term zidovudine recipients. *Journal of Infectious Diseases*, **167**, 526–532.
- Kozal, M.J., Shah, N., Shen, N. *et al.* (1996) Extensive polymorphisms observed in HIV-1 clade B protease gene using high-density oligonucleotide arrays. *Nature Medicine*, **2**, 753–759.
- Lai, C.L., Chien, R.N., Leung, N.W.Y. *et al.* (1998) A one-year trial of lamivudine for chronic hepatitis B. *New England Journal of Medicine*, **339**, 61–68.
- Longo, M.C., Berninger, M.S. and Hartley, J.L. (1990) Use of uracil DNA glycosylase to control carry-over contamination in polymerase chain reaction. *Gene*, **93**, 125–128.
- Mellors, J.W., Munoz, A., Giorgi, J.V. *et al.* (1997) Plasma viral load and CD4⁺ lymphocytes as prognostic markers of HIV-1 infection. *Annals of Internal Medicine*, **126**, 946–954.
- Montaner, J.S., Reiss, P., Cooper, D. *et al.* (1998) A randomized, double-blind trial comparing combinations of nevirapine, didanosine, and zidovudine for HIV-infected patients: the IN-CAS Trial Italy, The Netherlands, Canada and Australia Study. *JAMA*, **279**, 930–937.
- Morbidity and Mortality Weekly Report* (1998a) Guidelines for the use of antiretroviral agents in pediatric HIV infection. **47**, RR-4.
- Morbidity and Mortality Weekly Report* (1998b) Guidelines for the use of antiretroviral agents in HIV infected adults and adolescents. **47**, RR-5.
- Morris, T., Robertson, B. and Gallagher, M. (1996) Rapid reverse transcription-PCR detection of hepatitis C virus RNA in serum by using the TaqMan fluorogenic detection system. *Journal of Clinical Microbiology*, **34**, 2933–2936.

- Ngui, S.L. and Teo, C.G. (1997) Hepatitis B virus genomic heterogeneity: variation between quasispecies may confound molecular epidemiological analyses of transmission incidents. *Journal of Viral Hepatitis*, **4**, 309–315.
- O'Neill, H.J., Russell, J.D., Wyatt, D.E. *et al.* (1996) Isolation of viruses from clinical specimens in microtitre plates with cells inoculated in suspension. *Journal of Virological Methods*, **62**, 169–178.
- O'Shea, S., Newell, M.L., Dunn, D.T. *et al.* (1998) Maternal viral load, CD4 cell count and vertical transmission of HIV-1. *Journal of Medical Virology*, **54**, 113–117.
- Paya, C.V., Smith, T.F., Ludwig, J. *et al.* (1989) Rapid shell vial culture and tissue histology compared with serology for the rapid diagnosis of cytomegalovirus infection in liver transplantation. *Mayo Clinic Proceedings*, **64**, 670–675.
- Payan, C., Veal, N., Sarol, L. *et al.* (1996) Human cytomegalovirus DNA kinetics using a novel HCMV DNA quantitative assay in white blood cells of immunocompromised patients under ganciclovir therapy. *Journal of Virological Methods*, **65**, 131–138.
- Pepin, J., Simon, F., Dussault, A. *et al.* (1992) Rapid determination of human cytomegalovirus susceptibility to ganciclovir directly from clinical specimen primocultures. *Journal of Clinical Microbiology*, **30**, 2917.
- Perelson, A.S., Essunger, P., Cao, Y. *et al.* (1997) Decay characteristics of HIV-1-infected compartments during combination therapy. *Nature*, **387**, 188–191.
- Piatak, M. Jr, Luk, K.C., Williams, B. *et al.* (1993) Quantitative competitive polymerase chain reaction for accurate quantitation of HIV DNA and RNA species. *Biotechnology*, **14**, 70–81.
- Reichard, O., Norkrans, G., Fryden, A. *et al.* (1998) Randomised, double-blind, placebo-controlled trial of interferon α_{2b} with and without ribavirin for chronic hepatitis C. *Lancet*, **351**, 83–87.
- Saag, M.S., Holodniy, M., Kuritzkes, D.R. *et al.* (1996) HIV viral load markers in clinical practice. *Nature Medicine*, **2**, 625–629.
- Saiki, R.K., Gelfand, D.H., Stoffel, S. *et al.* (1988) Primer-directed enzymatic amplification of DNA with a thermostable DNA polymerase. *Science*, **239**, 487–491.
- Spector, S.A., Wong, R., Hsia, K. *et al.* (1998) Plasma cytomegalovirus (CMV) DNA load predicts CMV disease and survival in AIDS patients. *Journal of Clinical Investigation*, **101**, 497–502.
- Stirk, P.R. and Griffiths, P.D. (1988) Comparative sensitivity of three methods for the diagnosis of cytomegalovirus lung infection. *Journal of Virological Methods*, **20**, 133–142.
- Stuyver, L., Wyseur, A., Rombout, A. *et al.* (1997) Line probe assay for rapid detection of drug-selected mutations in the human immunodeficiency virus type 1 reverse transcriptase gene. *Antimicrobial Agents and Chemotherapy*, **41**, 284–291.
- Thomas, D.L., Villano, S.A., Riester, K.A. *et al.* (1998) Perinatal transmission of hepatitis C virus from human immunodeficiency virus type 1-infected mothers. *Journal of Infectious Diseases*, **177**, 1480–1488.
- Thomas, H.I. and Morgan-Capner, P. (1991) Rubella-specific IgG1 avidity: a comparison of methods. *Journal of Virological Methods*, **31**, 219–228.
- van der Bij, W., van Son, W.J., van der Berg, A.P. *et al.* (1989) Cytomegalovirus (CMV) antigenaemia: rapid diagnosis and relationship with CMV-associated clinical syndromes in renal allograft recipients. *Transplantation Proceedings*, **21**, 2061–2064.
- Victor, T., Jordaan, A., du Toit R. *et al.* (1993) Laboratory experience and guidelines for avoiding false positive polymerase chain reaction results. *European Journal of Clinical Chemistry and Clinical Biochemistry*, **31**, 531–535.
- Wittwer, C.T., Herrmann, M.G., Moss, A.A. *et al.* (1997) Continuous fluorescence monitoring of rapid cycle DNA amplification. *Biotechnology*, **22**, 130–138.
- Zeuzen, S., Ruster, B. and Roth, W.K. (1994) Clinical evaluation of a new polymerase chain reaction assay (Amplicor HCV) for detection of hepatitis C virus. *Zeitschrift für Gastroenterologie*, **32**, 342–347.
- Zuckerman, M.A., Hawkins, A.E., Briggs, M. *et al.* (1995) Investigation of hepatitis B virus transmission in a health care setting: application of direct sequence analysis. *Journal of Infectious Disease*, **172**, 1080–1083.

The *Herpesviridae*

Graham M. Cleator and Paul E. Klapper

University of Manchester, Manchester, UK

The *Herpesviridae* are a large family of enveloped double-stranded DNA viruses. To date, more than 150 members of the family have been identified. These viruses have been found in almost every species in which they have been actively sought, including both warm- and cold-blooded species, vertebrate and invertebrates. Some species appear to be the host of only one member of the *Herpesviridae*, while others harbour multiple viruses (e.g. nine herpesviruses have been found in *cercopithecine* species, eight herpesviruses in *equids*, and eight human herpesviruses are known).

Viruses included in the family *Herpesviridae* have a double-stranded DNA genome of between 80 and 150 million daltons molecular weight. The genome, tightly wound in the form of a torus, is enclosed within an icosadeltahedral capsid (triangulation number $T = 16$), 100–110 nm in diameter. The capsid is composed of 12 pentavalent capsomers (one at each apex) and 150 hexavalent capsomers. Each capsomer has a deep central indentation. An envelope surrounds the nucleocapsid from which numerous glycoprotein spikes project; these provide important antigenic determinants of the individual members of the group. Between the nucleocapsid and the envelope is an amorphous electron dense area—the tegument. The overall diameter of the enveloped particle is between 120 and 300 nm, depending upon the particular virus and the preparation method utilized for examination by electron microscopy. Following infection of their natural host, the viruses establish a latent infection, in which form they persist for the life of the host. In

this latent state only a small subset of the viral genes are expressed. Reactivation, with expression of viral proteins and production of progeny virus, may occur at intervals to produce recurrent infection. This allows virus transmission to new, susceptible hosts. Individual members are well adapted to their natural host and exhibit little or no ability to cause cross-species infection. The viruses encode many enzymes involved in nucleic acid metabolism, and the replication and assembly of progeny virus occurs in the host cell nucleus. The host cell is ultimately lysed as a result of virus infection. Several members of the *Herpesviridae* have strong oncogenic associations, most notable among the human herpesviruses being the associations of *Epstein–Barr virus* with nasopharyngeal carcinoma and Burkitt's lymphoma, and *Human herpesvirus 8* with Kaposi's sarcoma and abdominal cavity B cell lymphomas in patients with the acquired immune deficiency syndrome (AIDS).

The International Committee on the Taxonomy of Viruses divided the *Herpesviridae* family into three subfamilies, the *Alpha-*, *Beta-* and *Gammaherpesvirinae* (Roizman *et al.*, 1995), broadly on the basis of differences in the biological properties of the various viruses. Inevitably, a classification system based upon biological properties creates anomalies. It is acknowledged that this classification system is imprecise, being based upon artificial, subjective criteria. It is conceivable that, in the future, classification will exploit more objective parameters, such as the conservation of genes and gene clusters and their relative position in the genome;

Table 2.1 Human herpesviruses

Official name	Subfamily	Genus	Trivial name and abbreviation	Site of latency	G + C (moles %)	Genome (kb pairs)
<i>Human herpesvirus 1</i> (HSV-1)	Alpha-	<i>Simplexvirus</i>	Herpes simplex virus type 1	Sensory nerve ganglia	68	152
<i>Human herpesvirus 2</i>	Alpha-	<i>Simplexvirus</i>	Herpes simplex virus type 2 (HSV-2)	Sensory nerve ganglia	69	152
<i>Human herpesvirus 3</i>	Alpha-	<i>Varicellovirus</i>	Varicella zoster virus (VZV)	Sensory nerve ganglia	46	125
<i>Human herpesvirus 4</i>	Gamma-	<i>Lymphocryptovirus</i>	Epstein-Barr virus (EBV)	Leucocytes, epithelial cells	57	172
<i>Human herpesvirus 5</i>	Beta-	<i>Cytomegalovirus</i>	Human cytomegalovirus (CMV)	B lymphocytes	60	229
<i>Human herpesvirus 6</i>	Beta-	<i>Roseolovirus</i>	HHV-6	T lymphocytes (CD4 +), epithelial cells	43	160
<i>Human herpesvirus 7</i>	Beta-	—	HHV-7	T lymphocytes (CD4 +)	35	145
<i>Human herpesvirus 8</i>	Gamma-	<i>Rhadinovirus</i>	Kaposi's sarcoma-associated herpesvirus (KSHV)	B lymphocytes, epithelial cells	—	170

the presence and distribution of nucleotides that are subject to methylation; and genome sequence arrangements (Roizman, 1996). The last of these differences is particularly distinctive: six different structural forms of virion DNA have been identified among members of the *Herpesviridae* (reviewed by Roizman, 1996), differing in the presence and location of reiterations of terminal sequences of greater than 100 bp. However, at the present time detailed molecular biological data are available for only a limited number of the herpesviruses. As more information on the genomes of a wider number of members of the *Herpesviridae* emerges, a more precise classification system may evolve.

A formal binomial nomenclature is not applied presently in classification of the *Herpesviridae*. The International Committee on the Taxonomy of Viruses has decided that herpesviruses will be described by serial number and the family or subfamily in which the natural host of the virus is classified (e.g. *Bovine herpesvirus 1*, *Cercopithecine herpesvirus 1*). Each subfamily is divided into a series of genera. The sub-family *Alphaherpesvirinae* contains two genera: *Simplexvirus*, exemplified by *Human herpesvirus 1*; and *Varicellovirus* exemplified by *Human*

herpesvirus 3. The subfamily *Betaherpesvirinae* contains three genera: *Cytomegalovirus*, exemplified by *Human herpesvirus 5* (*Human cytomegalovirus*); *cytomegalovirus*); *Muromegalovirus*, exemplified by *Mouse cytomegalovirus*; and *Roseolovirus* as exemplified by *Human herpesvirus 6*. The subfamily *Gammaherpesvirinae* contains two genera: *Lymphocryptovirus*, exemplified by *Human herpesvirus 4* (*Epstein-Barr virus*); and *Rhadinovirus*, exemplified by *Ateline herpesvirus 2* and also *Human herpesvirus 8*.

As mentioned previously, the present classification, being based upon a summary of biological properties, is somewhat inexact. Within the human herpesviruses an example is the problem surrounding the classification of *Human herpesvirus 6* (HHV-6). All HHV-6 strains analysed can be segregated into one of two subtypes. Type B is the major aetiologic agent of *exanthem subitum* (Dewhurst *et al.*, 1993), while type A has no clear association with human disease. The subtypes differ in *in vitro* cell tropism, reactivity with monoclonal antibodies and T cell clones, and in nucleotide sequence. Thus the question arises: should these virus continue to be classified under the same name or are they distinct

viruses? The classification scheme for the *Herpesviridae* will doubtless evolve to accommodate such anomalies in the future.

There are presently eight members of the *Herpesviridae* known to infect humans (Table 2.1). The viruses are distributed worldwide and no animal reservoirs of infection are known for any of the human herpesviruses. The official names, *Human herpesvirus 1–8*, are, with the exception of *Human herpesvirus 6*, *7* and possibly *8*, seldom utilized and they are more usually known by their common names (*Herpes simplex virus type 1* and *type 2*, *Varicella zoster virus*, *Human cytomegalovirus*, *Epstein–Barr virus*). One further member of the *Herpesviridae*—*Cercopithecine herpesvirus 1*, common name ‘B’ virus—is known to occasionally infect humans. Transmitted by the bite of an infected

monkey, the virus may cause an ascending myelitis that may progress to a fulminant demyelinating encephalopathy.

REFERENCES

- Dewhurst, S., McIntyre, K., Schnabel, K. *et al.* (1993) Human herpesvirus 6 (HHV-6) variant B accounts for the majority of symptomatic primary HHV-6 infections in a population of US infants. *Journal of Clinical Microbiology*, **31**, 416–418.
- Roizman, B. (1996) Herpesviridae. In *Fields Virology* (eds B.N. Fields, D.M. Knipe, P.M. Howley *et al.*), pp 2221–2230. Lippincott-Raven, Philadelphia.
- Roizman, B., Deroisiers, R.C., Fleckenstein, B. *et al.* (1995) Herpesviridae: In: Sixth Report of the International Committee on Taxonomy of Viruses (eds F.A. Murphy, C.M. Fauquet, D.H.L. Bishop *et al.*). *Archives of Virology* suppl. 10, 586 pp.

Herpes Simplex

Graham M. Cleator and Paul E. Klapper

University of Manchester, Manchester, UK

THE VIRUSES

Human herpesvirus 1 (Herpes simplex virus type 1; HSV-1) and *Human herpesvirus 2 (Herpes simplex virus type 2; HSV-2)* are members of the *Herpesviridae*, subfamily *Alphaherpesvirinae*, genus *Simplexvirus*. The viruses are characterized by a short (18–24 h) replicative cycle that is cytolytic. Humans are the only natural host, although a wide range of primates and non-primates can be infected under artificial (laboratory) conditions. The genomes of HSV-1 and HSV-2 show considerable homology (~50%) but HSV-1 and HSV-2 are biologically and antigenically distinct. Infection with either virus may be clinically inapparent or may produce symptoms that range from the mild and trivial to those of severe disease. During infection the virus establishes latency in the nuclei of nerve cells in the local dorsal root ganglion. At intervals throughout the life of the host the virus may reactivate and is either shed silently or produces symptoms of recurrent infection. In immunocompromised individuals both primary infection and recurrent infection may be severe and life threatening.

Morphology

The morphology of the viruses, as seen by electron microscopy (EM), is identical for all members of the *Herpesviridae* (Figure 2A.1). By negative staining transmission EM the virus particle often appears to

be pleomorphic. The most accurate representation of the virion structure is obtained using the pseudoreplica EM technique. This reveals a spherical virus particle 150–200 nm in diameter with four structural elements:

- an electron opaque core;
- a protein capsid, surrounding the virus core, comprised of 162 capsomers;
- an amorphous tegument surrounding the capsid;
- an outer envelope with spikes on its surface.

The core of the virus is composed of linear double-stranded DNA packaged in the form of a torus. Data derived from electron micrographs suggest that the torus of DNA is physically stabilized within the capsid by a series of protein fibrils embedded in the underside of the capsid and passing through the central hole of the torus. The ends of the genome are probably held in close proximity within the capsid, since the DNA circularizes rapidly soon after it enters the host cell nucleus. The genomes of both HSV-1 and HSV-2 are approximately 152 kb in length (*c.* 100 million molecular weight). The G + C content of HSV-1 is about 68%, while that of HSV-2 is about 69%. The genome consists of a covalently linked 'long unique' and a 'short unique' base sequence, each of which is flanked by inverted repeat sequences (Figure 2A.2). The long and short unique elements can invert relative to one another, and four isomeric forms of viral DNA can be identified in infected cell cultures. The entire nucleotide sequence of the HSV-1 genome has been determined (McGeogh *et al.*, 1986, 1988) and a map showing its

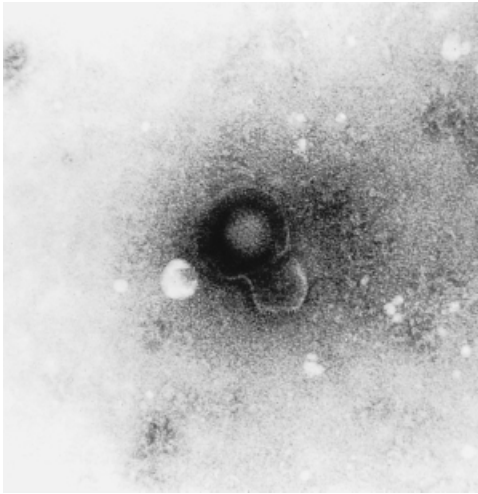

Figure 2A.1 Enveloped virus particle, HSV-1

functional organization has been published (Roizman and Sears, 1996). The genetic maps of HSV-1 and HSV-2 are largely colinear but differ in restriction endonuclease cleavage sites and in the apparent sizes of viral proteins. Up to 70 polypeptides are thought to be encoded by the genome, and 33 of these have been identified as structural (virion) proteins.

The viral capsid (100–110 nm in diameter) is a closed shell in the form of an icosadeltahedron ($T = 16$) with 162 capsomers arranged as 12 pentamers (vertices) and 150 hexamers (face and edges). Using high resolution cryo-EM and computer image reconstruction techniques the three-dimensional structure of empty capsids of HSV-1 has been determined to a resolution of approximately 26 Å

(Zhou *et al.*, 1994, 1995). These studies suggest the involvement of four proteins (VPs 5, 19c, 23 and 26) aggregated as pentons and hexons, which are associated with polypeptide triplexes to form the nucleocapsid. The interior of the capsid is accessible via transcapsomeric channels ('tubes') formed by the polypeptide arrangement of the pentons, hexons and holes at the base of each triplex. These openings are postulated to play a role in the transport of genomic DNA and scaffolding proteins during capsid morphogenesis.

Between the capsid and envelope is the tegument. An amorphous structure as visualized in thin-section EM, but with a fibrous appearance on negative staining. The tegument contains at least 12 proteins that are believed to have important functions in the early stages of virus replication following penetration of the host cell by the virion.

The virus envelope has a typical trilaminar appearance and is thought to be derived from patches of host cell nuclear membrane modified by the insertion of virus glycoprotein spikes. Numerous such spikes may be observed on the surface of the envelope, with lengths ranging from 8 to 24 nm (Stannard *et al.*, 1987).

REPLICATION

An appreciation of the replicative cycle of HSV is fundamental to an understanding of HSV disease and its control.

Initial attachment and penetration of the host cell is mediated via the glycoprotein spikes found on the

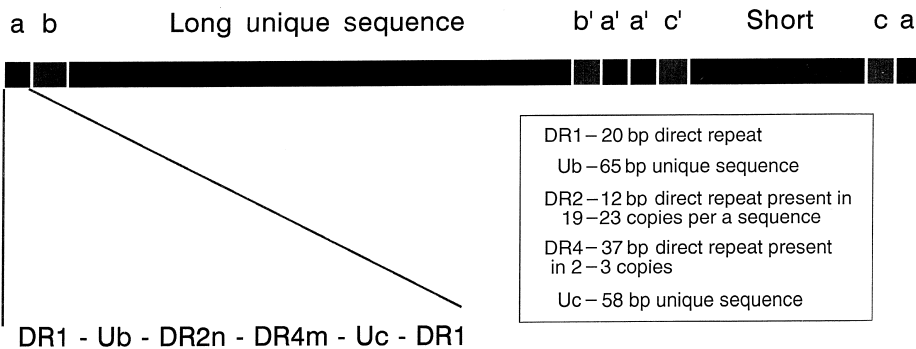

Figure 2A.2 The HSV genome. There are two covalently linked components designated 'L' (long) and 'S' (short). The four possible isomeric forms of the virus genome are created through inversions of the L or the S sequences. The L and the S components each consist of unique sequences bracketed by inverted repeats. The repeats of the L component are designated ab and a'b'; those of the S, a'c' and ca. The number of 'a' sequence repeats at the L–S junction and the L terminus is variable. The structure of the 'a' sequence is highly conserved but consists of a variable number of repeat elements; the detail shown is for HSV-1 strain F

Table 2A.1 HSV glycoproteins

Glycoprotein nomenclature ^a	Gene ^b	Essential for virus infectivity ^c	Function
gB	U _L 27	Yes	Forms a dimer, gB is essential for viral entry. Induces neutralizing antibody
gC	U _L 44	No	Involved in cell attachment
gD	U _s 6	Yes	Required after attachment of virus to cell, to allow virus entry into the cell
gE	U _s 8	No	Complexes with gE. Binds Fc portion of antibodies
gG	U _s 4	No	Involved in entry, egress and spread from cell to cell
gH	U _L 22	Yes	Forms complex with gL (see below); role in entry, egress and cell-cell spread
gL	U _s 7	No	gI and gE form a complex for transport to plasma membrane
gK	U _L 53	Yes	Required for efficient egress (viral exocytosis)
gL	U _L 1	Yes	Forms complex with gH which is required for transport of gH and gL to plasma membrane and for viral entry mediated by gH
gM	U _L 10	No	

^a Viral glycoproteins are named sequentially by letter as glycoprotein A, glycoprotein B, etc. The missing sequence letters (e.g. gA, gF) reflect earlier misidentification of precursors of glycoprotein species as the actual virion glycoprotein. A further glycoprotein, gI, has been predicted from DNA analyses (open reading frame U_s5) but has not been identified. There are a further two (the products of genes U_L20 and U_L34), and possibly more, non-glycosylated viral proteins inserted in the membrane.

^b Gene or transcriptional unit: U_s = unique short sequence of the genome; U_L = unique long sequence.

^c Information from *in vitro* experimentation with HSV-1. All glycoproteins are essential in 'wild-type' virus. In cell culture only some functionality can be dispensed with. Requirement of glycoprotein, non-essential in routine cell culture, can be demonstrated under specialized conditions, e.g. gC is essential for attachment to the apical surface of polarized MDCK cells; gI is essential for basolateral spread of virus in polarized cells.

surface of the virus envelope. These glycoprotein spikes have been extensively investigated (Table 2A.1) and the major antigenic differences between HSV-1 and HSV-2 relate to the type-specific epitopes found on certain of these glycoproteins (Bergstrom and Trybala, 1996).

Studies with deletion mutants, purified glycoproteins, peptides and monoclonal antibodies show that *in vitro*, at least five of the 10 virion glycoproteins are essential for virus entry to a host cell and for egress from the infected cell. It has not been possible to define either a single virus glycoprotein or a single cellular receptor as the sole means of virus attachment. Experiments in which the genes encoding particular glycoproteins were individually deleted failed to prevent each of the resulting virus constructs from attaching to non-polarized cells. It now seems likely that the virus is capable of attachment to more than one cell surface receptor, as blockade of one of the known cell receptors, heparan sulphate, does not prevent attachment of virus.

Attachment to the host cell activates a process, mediated by the virion surface glycoproteins, that induces fusion of the virion envelope and cell plasma membrane. This process probably involves several, if not all, of the virion surface glycoproteins and is accomplished very rapidly. Fusion results in the introduction of tegument proteins and viral nucleocapsid into the cell cytoplasm. Subsequently

host macromolecular metabolism is rapidly and efficiently shut down. Host DNA synthesis ceases, protein synthesis declines rapidly, ribosomal RNA synthesis is reduced and the glycosylation of host proteins ceases. There are at least 12 tegument proteins, and while the function of several of these is not understood, they are all believed to act directly or indirectly to produce early shut-off of host macromolecular synthesis and to contribute to the early events of replication. The virion host shut-off protein (VHS), for example, causes non-specific degradation of mRNA, leading to shut-off of macromolecule synthesis after infection. Conversely, some tegument proteins are believed to facilitate attachment of the nucleocapsid to nuclear pores and facilitate release of viral DNA. An important tegument protein is α -trans-induction factor (α -TIF), which is essential to the initiation of transcription of viral DNA (see below); two further tegument proteins (the products of U_L46 and U_L47) are reported to modulate its activity.

The nucleocapsid is transported through the cytoplasm to a nuclear pore. There is evidence from monoclonal antibody studies that the virus nucleocapsid proteins exhibit 'molecular mimicry' of host cell proteins, permitting the capsid to utilize the cell cytoskeleton for transport to the nuclear pore. On arrival at the nuclear pore, the capsid degrades and the virus DNA is released into the nucleus of the cell, where it circularizes immediate-

ly. To initiate transcription the circularized DNA must bind a host cell protein (OCT-1) to a *cis*-acting site; the tegument protein α -TIF binds an additional factor designated C1 (and possibly others). This α -TIF–C1 complex then binds to the OCT-1–DNA complex (Roizman and Sears, 1996). α -TIF acts in *trans* to induce α (or ‘immediate-early’) genes—the first set of viral genes to be transcribed. Viral gene expression is coordinately regulated and sequentially ordered in a cascade manner ($\alpha \rightarrow \beta \rightarrow \gamma$). The five α gene products are regulatory proteins; their expression is required for the production of all subsequent polypeptide groups. The proteins serve to *trans*-activate β and γ gene expression and to turn-off both α and early γ gene expression (other domains of the viral genome are transcribed under ‘ α ’ conditions including the ‘latency-associated transcript’ LAT-1, which will be discussed below). Viral DNA is transcribed throughout the replicative cycle by host RNA polymerase II.

The expression of the β genes results in the production of enzymes involved in nucleic acid metabolism (ribonucleotide reductase, thymidine kinase, thymidilate synthetase, alkaline DNase, dUTPase, etc.) and in DNA synthesis (DNA polymerase, helicase, primase, etc.). Peak rates of synthesis of β -gene products are observed 5–7 h postinfection and their appearance in the infected cell coincides with the commencement of viral DNA synthesis. HSV DNA is believed to replicate by a rolling circle mechanism yielding a concatomer that must be cleaved subsequently to package genome lengths of DNA within the nucleocapsid.

The synthesis of nucleocapsid and all other structural proteins occurs when γ gene expression is induced by β -gene products. Nucleocapsids assemble and encapsidate viral DNA within the host cell nucleus. A model to describe the cleavage of the concatomer of replicating DNA, packaging of a genome length of viral DNA within the nucleocapsid and restoration (repair) of the concatomer of DNA has been proposed (summarized in Roizman and Sears 1996). Virus glycoproteins undergo extensive post-translational modification during transit through the Golgi apparatus; they then become inserted in the nuclear and other cellular membranes. The tegument proteins also migrate to the cell nucleus and form patches underneath the modified nuclear membrane. Mature nucleocapsids bud through the nuclear membrane at these points and acquire their envelope and tegument. The virion

escapes from the infected cell by transit through the cisternae of the rough endoplasmic reticulum of the Golgi apparatus and cytoplasmic transport vesicles. Productive infection of a cell results in the destruction of the host cell through the major structural and biochemical changes induced by the viral replication.

PATHOGENESIS

Terminology

A *primary infection* refers to the first experience of HSV-1 or HSV-2 infection by a susceptible individual. If a person already infected with one type of virus (for example HSV-1) becomes infected with the other virus type (e.g. HSV-2), the infection is described as an *initial infection*. During primary infection and during initial infection the virus establishes a *latent infection* of sensory nerves at the local dorsal root ganglion. Subsequent reactivation of latent virus results in *recurrent infection*. If someone already infected with HSV becomes infected with the same strain of virus but at different site to the usual site of recurrent infection (e.g. transfer of HSV-1 from a cold sore to the eye), infection at the new site is described as an *endogenous reinfection*. Finally, it is possible that a person already infected with HSV may be reinfected with the same type of virus. Infection in this case is described as *exogenous reinfection*.

Overview

Humans are the only natural host of HSV. While animal studies have provided, and continue to provide, significant insights into the pathogenetic mechanisms of HSV infection of humans, it is important to appreciate that no animal model can exactly mimic human HSV disease.

The transmission of HSV requires direct contact between a susceptible individual (usually antibody negative) and a person actively shedding the virus. Transfer of virus is achieved by infection of mucosal surfaces or by entry through abrasions or cuts in the skin. Virus replication occurs at the site of infection and produces a short-lived viraemia. This primary infection is usually inapparent, but in a minority of

cases may lead to localized and even systemic symptoms. The site of infection is determined mainly by the route of transmission of the virus from the infected to the susceptible host. For HSV-1 it is the buccal cavity and oropharynx, and for HSV-2 the genital mucosa. HSV-1 and HSV-2 may, however, infect at either of these sites.

During the primary infection, virus comes into contact with the cutaneous receptors of local sensory nerves. Virus is believed to attach to and penetrate the nerve cell via these receptors. Once internalized the nucleocapsid moves to the perikaryon, utilizing the normal cellular retrograde axoplasmic flow. Viral DNA is released, enters the nucleus and immediately circularizes. A latent infection of the nerve cell is then established. In the latent state the virus is believed to exist as extrachromosomal circularized DNA (analogous to plasmids). No virions can be detected and no viral antigens appear to be expressed on or within the latently infected cell. The host immune response to infection rapidly eliminates virus and virus-infected cells from peripheral sites but does not recognize latently infected nervous tissue as harbouring virus, as no viral antigens are expressed.

The establishment of latency is central to the success of HSV as a human pathogen. Latency permits persistence of the virus in the presence of a fully developed immune response and allows lifelong infection of the host. As a result of periodic reactivation of latent virus and the production of recurrent infection, virus shedding occurs at intervals throughout life.

The underlying molecular mechanisms involved in the establishment and maintenance of latency are the subject of intensive study. Because current antiviral chemotherapy is effective only when the virus is replicating, it cannot eradicate latent virus. An understanding of the pathogenetic mechanisms involved in the establishment, maintenance and reactivation of latent infection is therefore fundamental to improved management of HSV disease.

Latently infected neurons apparently contain no viral protein but do contain numerous virus-specified RNA transcripts—the so-called latency-associated transcripts (LATs). Mutant viruses that do not produce LAT (i.e. LAT⁻) are, however, also capable of establishing latency. Current thinking is that these transcripts have no functional role in latency and that they are merely introns (i.e. a segment of RNA spliced out from the gene transcript

that does not code for a translated gene product). The product of the gene from which the LAT RNA is excised has not been identified in latently infected cells. A further point of interest is that latently infected neurons seem to harbour more than one viral genome per cell, and in animal experiments the numbers of copies per cell appears to increase with time. A host-dependent origin of DNA replication has been identified within the viral genome (Sears and Roizman, 1990) and thus the increase in the number of viral genomes might be explained in terms of host cell enzymes effecting replication of the viral DNA, independent of viral protein expression, in latently infected neurons. However, an understanding of the molecular events involved in the maintenance of latency remains elusive. The latent state appears to be effected by a repression of α genes or a lack of a host cell protein involved in α -gene transactivation, or both. As yet, no viral gene, including several of those found to be essential for productive viral infection *in vitro* and animal experiments, has been found to be essential for maintenance of the latent state. One of many theories (Roizman and Sears, 1996) is that within neuronal cells a further host cell protein—octamer-binding protein OCT-2 (and spliced variants thereof)—acts to inhibit the binding of the OCT-1- α TIF complex (see Replication, above), thereby preventing transactivation of α genes (Latchmann, 1996). Removal of OCT-2 allows the binding of the OCT-1- α TIF complex and viral genome expression (i.e. virus reactivation). The concentration of research into the mechanisms of latency will undoubtedly allow an understanding of the process to emerge.

The site of virus latency is related to the site of primary infection: for HSV-1 the trigeminal ganglia, and for HSV-2 the sacral ganglia, are the most common sites. Other dorsal root ganglia, including the superior cervical, vagal and geniculate ganglia, may also harbour virus. Although primary HSV-1 infection of the genitalia and primary HSV-2 infection of the oropharynx are often reported, recurrent infection of the genitalia by HSV-1 and recurrent orofacial infection by HSV-2 are rare. Infrequent reactivation is not thought to be due to a failure by HSV-1 to establish latent infection in cells of the sacral ganglia or of HSV-2 to fail to establish latent infection in cells of the trigeminal ganglion, since the respective genomes of the viruses have been detected at these sites. The inhibition seems to be at the level of effective viral gene expression in relation

to the particular environment of these sites. Sensory nerve ganglia may not be the only sites of latency of HSV. Using molecular techniques for the detection of viral nucleic acid, evidence for latency within the cornea, brain and other (non-neuronal) sites is accumulating.

Reactivation of latent virus produces recurrent infection. A variety of non-specific 'triggers' for this process have been described, including sunlight, cold, infection, stress, menstruation, ingestion of certain foods, etc. However, the molecular basis of such 'triggering' is not understood. A further conceptual difficulty is that productive herpes simplex infection is cytolytic. If the usual process of virus replication were followed in nervous tissue, an individual experiencing frequent reactivation over a period of years might be expected to experience loss of sensation through the progressive loss of sensory nerves. The damage might also be compounded through the action of the immune system because in a productive infection virus antigens are expressed on the infected cell surface, rendering the infected cell 'visible' to the immune system. Various models have been proposed (Ho, 1992; Roizman and Sears, 1996) to explain this process, although none are entirely satisfactory. It seems likely that virus replication in nervous tissue is somehow restricted, with no expression of virion glycoproteins on the cell surface (thereby permitting the cell to escape immune-mediated cytolysis) and no irreversible damage (cell lysis) to the host neuron. Studies of HSV-1 infection of cultured human embryonic dorsal root ganglion cells (Lycke *et al.*, 1988) suggest that egress of virus from sensory nerves is accomplished via anterograde axoplasmic flow in transport vesicles. The released virus infects adjacent skin cells, replicates and infects further cells by cell-to-cell passage, leading to the distinctive lesions of recurrent HSV infection.

Immune Response to Infection

Recovery from HSV infection and the control of reactivated virus infection involves all components of the immune system acting in concert as an immune 'network' (Jerne, 1976). The host's genetic make-up, macrophages, specific T cell populations, complement, specific antibodies, and lymphokine and cytokine responses all have an important role

in the immune response to HSV infection.

Humoral Immunity

Western blot and radioimmune precipitation experiments show that serum from patients recovering from severe HSV infection may contain antibody to all 33 structural (virion) proteins of HSV. The actual number and quantity of antibodies detected correlate with the severity of infection, and in mild infection only a restricted number of antibodies may be detectable.

The immune response is directed principally to the glycoprotein spikes (Table 2A.1) found on the virion envelope and on the surface of virus-infected cells. Neutralizing and cytolytic antibodies may be detected; glycoprotein D being the most potent inducer of neutralizing antibody. In a primary infection, an IgM subclass response is detected just before, or at the same time as, an IgG and IgA immune response. The response is relatively short-lived but IgM antibody may also be detected during recurrence, rendering serological differentiation of primary from recurrent infection difficult. Both IgG and IgA antibody persist, although the IgG antibody response is of greater magnitude. Repeated HSV recurrences lead to a gradual boosting of antibody levels but individual reactivation events, or even reinfection, may not result in a significant increase in circulating antibody. The presence of serum antibody may not protect from reinfection, and neither the quantity nor the range of reactivity (i.e. the lack of antibody to a particular virus protein) appears directly to influence either the frequency or severity of reactivation events.

The early immune response to HSV is relatively type specific but 'later' antibody is more broadly cross-reacting. Monoclonal antibody studies show that both type-common and type-specific epitopes may be found on virion glycoproteins. As a major part of the humoral immune response is directed to virion glycoproteins, the change from type specificity with time presumably reflects temporal changes in the relative preponderance of antibodies to type-specific and subsequently type-common epitopes on the virion glycoproteins.

Cell-Mediated Immunity

The cellular immune response to infection involves a complex interaction of natural killer cells, macro-

phages, T lymphocytes and associated cytokines. Most adults can be shown to be HSV seropositive and are therefore presumed to harbour latent virus. About 45% of this population give a history of herpes labialis. Some may recall only one recurrence, while others report frequent episodes. If seropositive persons with no history of herpes labialis are monitored, silent virus shedding may be shown to occur at intervals. Differences in humoral immune status fail to explain these observations. The appearance or non-appearance of clinical symptoms and the severity of these symptoms are perhaps most easily explained in terms of differences in the cell-mediated immune responsiveness (CMI). Thus in patients with known cellular immune deficiencies, herpes labialis occurs frequently and is a very much more severe and prolonged disease. Unfortunately, in individuals without overt cellular immune deficiencies, determination of relative differences in CMI between those with few recurrences and those with frequent recurrences is not easily accomplished.

Virus-induced Modulation of the Immune Response

In *in vitro* cell culture experiments and in animal experiments HSV-1 has been shown capable of preventing apoptosis in differentiated cells. Premature death of a virus-infected cell presents one of a range of possible host responses to prevent the spread of virus to other, as yet uninfected cells. The products of gene mapping in the long unique component of the viral genome, particularly the γ 34.5 gene (Chou and Roizman, 1994), appear to be involved in this process. The viral glycoproteins expressed on the surface of the infected cell provide further modulators of the immune defence. The complex of glycoproteins E and I (Table 2A.1) produces an Fc receptor which binds monomeric IgG molecules. Glycoprotein E, by itself, provides a further type of Fc receptor binding polymeric IgG molecules. Glycoprotein C has been shown to bind the C3b component of complement, possibly through mimicry of the C3b receptor CR1. The effect of these molecules is presumably to interfere in antibody interaction with infected cells and virions, and complement-mediated and antibody-dependent cytotoxic T cell destruction of virus-infected cells. A further effect of HSV is to prevent the induction of CD8 + T lymphocytes. It is known that HSV-

caused epithelial lesions contain a disproportionately high number of CD4 + cells and relatively few CD8 + cells. It appears that the product of the α 47 gene of HSV renders cells resistant to the activity of CD8 + lymphocytes by retaining MHC class I molecules in the cytoplasm, resulting in a lack of peptide presentation on the cell surface (York *et al.*, 1994). Undoubtedly other HSV-induced mechanisms operate to interfere in antigen presentation and processing and the combination of molecular biological and immunological investigation promises to continue to provide fascinating information on the adaptation of these viruses to their natural host.

Pathogenesis in Immunocompromised Patients

Congenital deficiencies in humoral immunity (hypogammaglobulinaemia or even agammaglobulinaemia) do not appear to be significant risk factors for serious primary or recurrent HSV disease. Congenital deficiencies in CMI may, however, be associated with severe HSV disease. The risk of serious disease varies with the particular immune deficit; for example, patients with congenital athymic aplasia (DiGeorge syndrome) do not appear to be at particular risk, while those with severe combined immune deficiency, such as the Wiskott–Aldrich syndrome, are. These differences emphasize the complex interplay of the immune network in controlling HSV infection. Severe HSV disease is also observed in infants, children and adults with deficiencies in CMI induced by ‘therapy’. These include recipients of cytotoxic chemotherapy (e.g. for cancer) and recipients of major organ grafts. The severity of HSV disease in these patients is related to the type and degree of immunosuppression. Severe primary and recurrent HSV infections also occur in patients with AIDS.

EPIDEMIOLOGY

HSV has a worldwide distribution and is endemic in all human population groups examined. There appear to be no animal reservoirs for the infection. The rate of infection and the timing of primary infection differs for HSV-1 and HSV-2, reflecting the differences in the major modes of transmission of the two viruses.

Primary HSV-1 Infection

Primary HSV-1 infection occurs when a susceptible individual comes into close, intimate contact with an individual suffering recurrent infection. Thus infants become infected when their parents or relatives kiss them; adolescents who escape infection in infancy are usually infected later by kissing. Infection in an infant is likely to be missed or dismissed as 'teething'. In adolescents infection is more commonly symptomatic but rarely severe. Because the majority of primary infections are asymptomatic, epidemiological data collected by observation of clinically apparent disease provide only a partial measure of its true incidence. For accurate data collection serological studies must be employed.

The broad principles of the seroepidemiology of primary HSV-1 infection were established in the classic study of Burnet and Williams (1939) and have since been confirmed in numerous studies. Burnet and Williams showed that in the first 6–9 months of life infants escape infection by virtue of passively transferred maternal immunity. Afterwards infants become infected and develop HSV IgG antibody. The majority of these seroconversions occur during the first 5 years of life and those who escape infection in infancy undergo seroconversion during adolescence or in early adulthood. A relationship between the age of acquisition of the virus and socioeconomic status was also found. Populations associated with a low socioeconomic environment collectively exhibited earlier acquisition of HSV infection than more affluent populations, although in both groups 90–95% infection rates were observed by early adulthood and primary HSV-1 infection was a rare event in those of > 30 years of age.

In recent years seroepidemiological studies have shown that in developed countries there has been a lowering in the overall prevalence of HSV-1 antibody (rates of 70% or lower are often reported among 30–40-year-old adults). In these countries, in children, in adolescents and, particularly in those from a high socioeconomic class, in young adults, a significant lowering in seroprevalence is evident. However, even within individual countries there are wide variations in seroprevalence; for example, inner-city residents generally exhibit higher seroprevalence rates than those from rural areas. The

major mediator of seroprevalence is the frequency of direct person-to-person contact. In crowded areas (e.g. disadvantaged inner-city areas) seroprevalence is highest; in affluent, rural areas, seroprevalence is lowest. On a worldwide basis however, overall rates of 90–95% seroprevalence are still commonplace in adult populations.

Primary HSV-2 Infection

HSV-2 transmission is apparently less efficient than that observed for HSV-1. The principal route of transmission is via sexual activity. Although some infants acquire HSV-2 infection, in most cases primary infection is delayed until the onset of sexual activity in adolescence and early adulthood. At this time the majority will have already experienced primary infection with HSV-1 (i.e. infection with HSV-2 usually causes an *initial* rather than a *primary* infection). Because of the shared antigenicity of HSV-1 and HSV-2, HSV-1 immunity may be partially protective and not all those exposed to HSV-2 will necessarily become infected. Also, since transmission usually requires sexual contact, the number of exposures to the virus will inevitably be lower than the number of exposures to HSV-1 infection.

A major problem in determining the seroepidemiology of HSV-2 infections has been the lack of well-characterized methods to differentiate HSV-1 and HSV-2 antibody. Only very recently have relevant assays become available on a commercial basis (see diagnosis below). At the present time seroepidemiological studies of HSV-2 are thus incomplete. However, the data collected to date suggest that the major influence on acquisition of HSV-2 infections is, as might be expected for a sexually transmitted virus, the number of sexual partners. Rates of up to 95% seroprevalence have been reported in some female commercial sex workers. In the general population there are wide differences in seroprevalence between different patient groups and even between apparently similar social groups in different cities. Women are generally infected at an earlier age than men, and rates of infection in women are higher for all age groups up to and including those of 45 or more years of age. Studies among genitourinary medicine clinic patients suggest that only in homosexual men do the rates of

infection with HSV-2 match those found in women; although, even in this context, it is not until age 40–45 that equivalent rates are observed. The majority (80% or more) of those found to be HSV-2 antibody positive cannot recall primary infection with the virus and either do not recall, or are unaware of, recurrent genital herpes, emphasizing that, as with primary HSV-1 infection, the majority of primary infections are mild and clinically 'silent'.

The changing seroepidemiology of HSV-1 infections in developed countries and changes in sexual practices have led to suggestions that the epidemiology of genital herpes is changing. In some UK studies 40–60% of isolates of HSV from first-episode genital herpes have been found to be due to HSV-1. These data have not been corroborated in other centres where more usually only 10–20% of first episode genital HSV isolates are found to be HSV-1.

Recurrent HSV-1 and HSV-2 Infection

Both silent and overt (i.e. symptomatic) recurrences of HSV-1 and HSV-2 infection occur. Thus without continuous monitoring of a cohort (by virus isolation studies) accurate data on rates of recurrence cannot be obtained. Only 38–45% of an adult population (in whom seroprevalence rates of 90–95% are reported) will give a history of recurrent herpes labialis.

The frequency of recurrence of genital HSV-2 infection is thought to be higher than that observed in HSV-1 herpes labialis, although the number of lesions produced per episode and their duration are generally shorter. The rate of recurrence is believed to be slightly higher in men than in women, with rates of up to 2.7 and 1.9 episodes per 100 patient-days, respectively. Overall about 60% of those infected with HSV-2 infection will report recurrent infection.

Endogenous and Exogenous Reinfections

Reinfection, recognized by the appearance of lesions at another body site, for example infection of the finger (herpetic whitlow), can occur at any age. Differentiation of endogenous and exogenous re-

infection can only be accomplished by isolation of strains of virus from two sites and demonstration of genetic polymorphism by restriction enzyme analysis of their respective DNAs.

CLINICAL FEATURES

Oropharyngeal and Orofacial Infection

In a symptomatic primary HSV infection involving the oropharynx, gingivostomatitis is the most common symptom. The incubation period ranges from 2 to 12 days, with a median of 4 days, and the duration of clinical illness is 2–3 weeks. The spectrum of severity ranges from the trivial, involving the buccal and gingival mucosa, to severe, painful, ulceration of the mouth, tongue, gingivae and fauces. In severe disease, shallow ulcers on an erythematous base evolve from vesicles and often coalesce, particularly on the mucosa of the cheeks and under the tongue. The ulcers are observed on the hard rather than the soft palate—a feature that may help differentiate herpetic ulcerations from those caused by the Coxsackieviruses ('herpangina'). In young children the skin around the mouth is frequently involved. Submandibular lymphadenopathy and fever (39–40°C) are common and may produce febrile convulsions in children. A moderate lymphocytosis (up to 700 mm^{-3}) and mild neutropenia are frequently observed. Elevated liver enzymes are noted in occasional cases. Acute gingivostomatitis is a self-limiting disease and the resolution begins abruptly. The lesions become painless and inflammation subsides. Intraoral ulceration progresses to healing, although crusting of lesions, as seen in resolving cutaneous HSV infection, is not usually observed. The patient becomes afebrile and symptoms regress rapidly, although lymphadenopathy may persist for several weeks.

Other symptoms that may be associated with primary infection include sore throat, mild conjunctivitis, nausea and vomiting, myalgia and abdominal discomfort. Dehydration and anorexia may result through mouth discomfort and difficulty in swallowing associated with the pain and oedema of the mucosal membrane infection. Older patients may experience a pharyngitis associated with a mononucleosis syndrome (up to 20% atypical lymphocytes). Tonsillar ulceration is observed fre-

quently in pharyngitis, together with submandibular lymphadenopathy.

The oral disease can be associated with lesions elsewhere. Herpetic dermatitis, nasal herpes, ocular herpes, herpetic whitlows and even genital herpes are not infrequent complications of primary HSV infection of the mouth. These probably represent endogenous reinfections caused by autoinoculation from the site of primary infection.

Recurrent infection, triggered by a variety of apparently non-specific stimuli, such as fever, stress, cold, menstruation or ultraviolet radiation, appears as a fresh vesicular eruption termed 'herpes labialis', 'herpes febrilis', 'fever blisters' or 'cold sores'. The most frequent site is at the border of the lips but lesions may appear elsewhere—for example, on the chin, cheek and on, or inside, the nose. Their appearance is usually preceded by a prodrome of tingling or itching at the site where recurrence will occur. In the immunocompetent, the area of involvement is usually small and vesicles progress to the pustular and crusting stage within 3–4 days (Figure 2A.3, *see* Plate I). The time for complete healing is variable (5–12 days, mean 7.5 days).

Asymptomatic oral shedding of HSV can occur and is occasionally preceded by a prodrome similar to that associated with overt herpes labialis. In the immunocompetent complications of recurrent infection are rare.

Recurrent intraoral ulcers are caused only rarely by HSV. In the few instances where reactivation of HSV is responsible, lesions are limited to the gingivae and the hard palate. Severe cellular immune deficiency can, however, lead to extensive ulceration of the mouth, and involve the pharynx and oesophagus.

Genital Infection

In comparison to primary infection of the oropharynx, primary genital infection is often a more severe clinical disease that may last up to 3 weeks. Fever, dysuria associated with urethritis and cystitis (with urinary retention in a proportion), localized inguinal adenopathy and malaise is common. A prominent feature of primary genital herpes is pain, which, especially in women, may be severe. In women the lesions are located principally on the vulva but the vagina and cervix are almost always

involved. The lesions may extend to the perineum, upper thigh and buttocks. In men, vesicular lesions with an erythematous base are observed on the glans of the penis or on the penile shank. Perianal and anal infections producing proctitis are common in homosexual men.

Sacral radiculomyelitis is sometimes observed, with urinary retention and attendant neuralgia. Secondary microbial infections often follow primary genital HSV infection and their occurrence necessitates appropriate antimicrobial therapy. Primary (maternal) genital herpes occurring at or around the time of birth may produce severe neonatal infection. Aseptic meningitis associated with primary genital HSV-2 infection is occasionally observed.

In recurrent genital herpes a limited number of vesicles are produced and their appearance is usually associated with a localized irritation rather than with significant pain. In comparison to herpes labialis, recurrent lesions in the perineal area tend to be more numerous and can persist longer than their oral counterparts. New vesicles often appear during the course of a recurrence, and delay healing. The mean healing time in recurrent genital herpes may be up to 15 days, compared to an average of 7.5 days in recurrent oral disease. Complications (neurological or systemic) associated with recurrent infections are rare.

Ocular Infection

The early symptoms of herpes keratitis are of a unilateral or bilateral conjunctivitis, with preauricular lymphadenopathy. The most common first presentation is, however, of a unilateral, characteristic, dendritic (branching) ulcer (Figure 2A.4, *see* Plate I). The normal course of the disease is 3 weeks, but if ulcers are large, healing can be slow. Mild systemic disturbances, blepharitis and circumocular herpetic dermatitis are commonly present during the primary infection. Infection may occur as a part of a primary infection but most cases are thought to represent an endogenous reinfection caused by autoinoculation from the site of a recurrent infection. Almost all cases are due to HSV-1. New HSV infections of the eye are estimated to occur at a rate of about 50 000 per year in the UK and up to 300 000 per year in the USA.

A single recurrence of ophthalmic infection is observed in between 20 and 30% of patients within 2 years of the first infection. Subsequent recurrences are less common but if a second recurrence does occur then further recurrences will be observed in 40–45% of these cases. There are several forms of recurrent ophthalmic infection that may occur in combination. Dendritic or larger 'geographic' ulcers are usually the first manifestation of recurrence, with the patient complaining of ocular irritation, lacrimation, photophobia and sometimes blurring of vision. Infection is usually confined to the superficial layers of the cornea and stromal involvement is absent or only relatively mild. Days or weeks after the recurrent infection the corneal epithelium may ulcerate to form a nondescript ovoid ulcer (i.e. post-infectious or metaherpetic keratitis). Virus replication does not appear to be directly responsible for the production of this ulcer. If the ulceration is prolonged (weeks and months), collagenolytic activity may appear, leading to stromal melting and perforation. This form of disease requires careful management if these serious sequelae are to be avoided.

Repeated and severe epithelial disease recurrence or chronic epithelial keratitis leads to involvement of the deeper layers of the cornea, producing interstitial or disciform keratitis. Neovascularization and scarring may ultimately lead to loss of vision. HSV infection is second only to accidental injury as the major cause of blindness in developed countries.

The observation of recurrent infection of the cornea raises questions as to extraneuronal sites of latency of HSV. Restriction endonuclease analysis of viral DNA isolated from successive ocular recurrences suggests the same strain of virus is involved in each recurrence. Repeated autoinoculation of the virus from a cold sore seems unlikely and virus latency in the ophthalmic division of the trigeminal ganglion and spread to the cornea in the tear film might not explain the recurrence of virus infection in the same region of the cornea in each episode. Thus extraneuronal virus latency within the cornea has been suggested. Using the polymerase chain reaction it has proved possible to demonstrate HSV DNA within corneal cells of both normal and diseased corneal tissues obtained at keratoplasty. Moreover, infectious virus has been isolated using cocultivation techniques from corneas obtained from patients with stromal herpes keratitis. These observations do not in themselves prove that cor-

neal latency of HSV occurs (they might reflect low-grade virus persistence rather than latency) and further work will be required to allow firm conclusions to be drawn.

The influence of the immune response in control of ocular infection is an additional area of interest in the pathogenesis of ocular HSV infection. Because of the unique anatomy and physiology of the eye, the local immune response to infection may differ from that occurring at, for example, cutaneous sites. The lack of, and/or relative overproduction of, individual components of the immune response undoubtedly influences disease pathogenesis at this site.

Recurrent iridocyclitis and occasionally panuveitis may be caused by HSV. Iridocyclitis, produced by intraocular inflammation, is observed often in association with active herpes keratitis. It may be due to direct involvement of the virus or may be secondary to the irritative effects of keratitis.

Ophthalmic disease associated with intrauterine and neonatal infection with HSV (see below) can present at keratoconjunctivitis or later as choriooretinitis, but cataract, corneal ulceration, anterior uveitis, vitritis, optic atrophy, nystagmus, strabismus, microphthalmia and retinal dysplasia have all been reported in association with such infection. Ocular manifestations are more common in those infected *in utero* than in those infected *intra-* or *postpartum*.

Neonatal Herpes

The reported incidence of neonatal herpes varies from extremes of 1 case in 2500 live births (Alabama, USA; Whitley 1993) to 1.65 per 100 000 live births reported in a UK survey (Tookey and Peckham, 1996). This variation reflects both the wide variation in HSV-2 seropositivity found in different geographical and socioeconomic groupings and the difficulties in diagnosis of the condition. Symptoms at presentation can range from the very severe, associated with high mortality, to the relatively mild, which none the less can be a cause of significant residual morbidity. Congenital infection is rare: most neonatal herpes is a result of perinatal infection. A few cases occur as a result of transmission of oral herpes from the mother, her relatives or hospital staff in the immediate postdelivery per-

iod. Both HSV-1 and HSV-2 can cause neonatal herpes but the majority of cases are due to HSV-2. In general HSV-1 infection poses a lower risk for long-term sequelae, although this distinction is not absolute.

Primary and also initial infection during the first or second trimester of pregnancy is not associated with significant risk. When infection occurs during the third trimester there is a risk of transmission to the baby during vaginal delivery. Risk is highest when infection occurs around the time of labour (Smith *et al.*, 1998).

Primary maternal genital herpes poses the greatest threat to the neonate, although recurrent genital herpes is also a risk. Most mothers bearing children who develop neonatal herpes *do not* have genital lesions at delivery.

American studies (Whitley, 1990) suggest that neonatal herpes may manifest as disease localized to skin, eye and mouth; encephalitis with or without skin, eye and mouth involvement; and disseminated disease with multiorgan involvement including CNS, lung, liver, adrenals, eyes and skin. Symptoms appear 4–5 days postpartum, with most peripheral and disseminated infections being evident at 11–12 days and most CNS disease appearing by 17–18 days. In the absence of therapy, mortality in disseminated disease exceeds 80%, and exceeds 50% in those with CNS symptoms only. Both forms of disease are associated with severe morbidity. Babies exhibiting only skin, eye and mouth infection may suffer permanent ocular damage, and most will, if followed for a sufficient period of time, eventually show some sign of neurological impairment. All HSV infections identified in the neonatal period therefore warrant antiviral therapy.

Herpes Simplex Encephalitis

The most common presentation of herpes simplex encephalitis (HSE) is a focal encephalopathic process with signs and symptoms that localize to the frontotemporal and parietal areas of the brain. As the disease progresses, symptoms increase in severity and there is progressive decrease in consciousness, leading, in severe cases, to coma and death. In the majority of patients there is a history of a 'flu-like' illness occurring at some time in the 2 weeks preceding the appearance of neurological symp-

toms. Herpes encephalitis occurs in all age groups and approximately the same number of cases occur in men as in women. There is no seasonal variation in incidence and cases occur sporadically. Precise estimates of the incidence of HSE are not possible because of underreporting, but estimates of incidence range from about 1 case per million population per year to 1 case per 200 000. Most cases are caused by HSV-1, with HSV-2 causing 2–6.5% of cases. In the immunocompromised, 'classical' herpes encephalitis appears to occur at the same rate as in the immunocompetent, although in AIDS patients an atypical, subacute encephalitis associated with either HSV-1 or HSV-2 has been identified in 1–2% of cases studied at autopsy, usually in association with a concurrent cytomegalovirus infection of the CNS (Cinque *et al.*, 1996).

The onset of disease may be either abrupt or insidious. In the early stages, signs and symptoms of the infection may be incomplete. Electroencephalographic examination (EEG) will usually reveal non-specific slow-wave activity during the first 5–7 days of illness. Later, more characteristic paroxysmal sharp waves or triphasic complexes with a temporal predominance can be found. Low-density lesions are demonstrable by X-ray computed axial tomography (CT) in about 70% of cases, within 5 days of the onset of neurological illness. Proton magnetic resonance imaging (MRI) has the potential to detect abnormalities that may not be revealed by routine CT. MRI can show frontobasal and temporal lesions as hypointense lesions on T₁-weighted images and hyperintense lesions on proton density and T₂₁-weighted images at an earlier stage than changes can be detected by CT.

The histopathological changes associated with severe HSE consist of acute inflammation that evolves to produce haemorrhagic and necrotizing lesions. The lesions are characteristically located in the temporal lobes and orbital surface of the frontal lobes, but adjacent frontal, parietal and occipital lobes and the cingulate gyri may also be involved. Clinically, herpes encephalitis ranges in severity from a mild encephalitis of low mortality and morbidity to severe necrotizing encephalitis associated with both high mortality (70–90% in the absence of specific antiviral chemotherapy and expert neurological care) and high morbidity (with only 10% of survivors returning to normal neurological function in the absence of antiviral chemotherapy). Herpes encephalitis is, however, a treatable disease and

prompt initiation of chemotherapy using the antiviral drug acyclovir, combined with intensive neurological nursing care, results in a reduction of mortality to less than 20%, with up to 40% of survivors returning to apparently normal neurological function. In some patients there may be residual neurological deficit: this may be severe, with impairment, or complete loss, of short-term memory being the most commonly observed sequelae.

In contrast to several other enveloped viruses (including *Varicella zoster virus* (VZV), *Epstein-Barr virus* and *Human cytomegalovirus*), HSV does not seem to be a significant cause of perivascular leucoencephalopathy ('postinfectious encephalitis'). However, this disease has been reported to occur in a minority of patients recovering from acute herpes encephalitis. Between 5 days and 3 weeks after apparent recovery from acute encephalitis the patient suddenly develops a relapse and a further bout of encephalitic illness. In the small number of cases examined by brain biopsy no virus antigen has been detected and histopathologically lesions are similar to those seen in postinfectious encephalitis triggered by other virus infections (i.e. significant demyelination and immune cellular infiltration). Viral DNA is usually not detected in the cerebrospinal fluid (CSF) and most patients survive and recover to at least their level of disability following acute herpes encephalitis.

The pathogenesis of herpes encephalitis remains enigmatic. The structure of the vasculature within the brain, together with the meninges surrounding the brain, represents, in the physiologically normal host, a significant barrier to virus entry to brain parenchyma. Haematogenous spread of virus to the brain is usually prevented by these blood-brain and blood-CSF barriers. To gain access to the brain the virus must circumvent the physiological/anatomic barriers. Virus may achieve this by transit from the periphery within nerve cells. Various pathways have been proposed, although in all probability no one route explains all cases of herpes encephalitis.

Once within the brain the spread of virus represents a fascinating and largely unexplained area of neurovirology. At least in the early stages virus infection is principally of neurons, with only relatively occasional involvement of astrocyte and glial cells. The frontal and temporal lobes together with the associated limbic structures of the brain appear to be the primary targets of the infective process (Esiri, 1982) and has led to the suggestion that this

localization reflects the particular neurochemical and perhaps local neuroimmunological environment of the limbic region (Damasio and Van Hoesen, 1985); however, such localization is not observed in all cases and virus may spread to involve other regions of the brain.

Disease in the Immunocompromised

Patients who are immunocompromised through deficits in CMI are at risk of severe HSV infection, with the possibility of life-threatening, disseminated infection. Oral HSV infection can progress to extensive necrotic mouth ulceration, with bacterial superinfection or haemorrhage in those with thrombocytopenia. Equally severe, progressive genital HSV infections may occur. Antoinoculation may result in initial infection at sites distant from the original focus. Cutaneous dissemination can take place and may be clinically indistinguishable from varicella. Visceral dissemination is also possible with hepatitis, pneumonia and encephalitis. Primary, recurrent and exogenous reinfections all pose a significant threat to such patients. In organ transplant recipients, progressive disease may involve the oesophagus, respiratory tract and even the gastrointestinal tract—the severity of disease observed in such patients being linked with the degree of immunosuppression. In patients with human immunodeficiency virus (HIV) infection, recurrent HSV infection may occur with high frequency at multiple sites; widespread cutaneous distribution may occur; and markedly prolonged times to healing of lesions are observed. Prolonged viraemia in such patients leads to multiorgan distribution, including dissemination to the CNS.

Herpes Simplex Dermatitis; Herpetic Whitlows; Traumatic Herpes; Herpes Gladiatorum

Herpetic dermatitis is a complication of primary infection. Perioral or periorbital herpes simplex regularly accompanies more severe primary gingivostomatitis or primary/initial herpes keratitis. In babies, seeding of the virus can involve large areas of the face and, when transferred to the anogenital area by scratching, may involve the whole napkin

area. In primary HSV vulvovaginitis, vesicles readily appear on the perineum and thigh.

In patients with atopic eczema or with Darier's disease the normal resistance of the skin to HSV infection is reduced and primary, recurrent and possibly both endogenous and exogenous reinfection may produce eczema herpeticum. Eczema herpeticum as a primary infection carries a small but significant mortality through progression to severe generalized disease.

Under normal circumstances, HSV does not readily penetrate healthy skin but when the dermis is breached, a portal of entry is created. Health care personnel are at particular risk of perforation injuries. Direct inoculation of virus into the fingers of those who constantly manipulate in the oral cavity (dentists, dental nurses, intensive care doctors, nurses and anaesthetists) leads to herpetic whitlow, an inflammation of the nail folds. A similar condition is seen in children and adolescents who transfer their own oral virus through nail biting. In other situations, workers such as hairdressers, dress-makers and laboratory personnel can be infected by accidental stab injuries with contaminated needles or broken glassware (traumatic herpes).

Herpes gladiatorum and 'scrum pox' are conditions spread among wrestlers through bites or 'mat burns', and rugby players through bites and facial scraping. The appearance of herpetic vesicles at 'unusual' sites can sometimes be explained by an inquiry into the individuals athletic pursuits!

A distinct form of cutaneous infection 'zosteriform herpes simplex' is an infrequent presentation of herpes simplex but is recognized when the distribution of HSV lesions accords with a dermatome and otherwise resembles zoster. Unlike zoster, nerve root pain is not a feature.

Erythema Multiforme

Erythema multiforme is regarded as a hypersensitivity phenomena precipitated by a variety of infectious agents, immunizations and drugs. The clinical lesions are characteristic: acraly distributed erythematous papules which evolve into concentric 'target' lesions; annular plaques and bullae may also be produced. Although usually mild and self-limiting, the disease can be recurrent or progress to toxic epidermal necrolysis, or severe mucous membrane

involvement (Stevens-Johnson syndrome). *Mycoplasma pneumoniae* and HSV are the infectious agents most commonly associated as precipitants. Up to 65% of patients with recurrent erythema multiforme give a preceding history of herpes labialis, on average 11 days before the lesions of the disease appear. Infectious virus cannot be cultured from the lesions but immunofluorescence studies have shown HSV glycoprotein B located around keratinocytes in the viable epidermis, polymerase chain reaction (PCR) studies have detected HSV DNA in cutaneous lesions, and *in situ* hybridization has been used to demonstrate HSV nucleic acids within the epidermis.

Erythema multiforme does not respond directly to antiviral chemotherapy (HSV replication is apparently a precipitant of the disease but not a direct cause of the pathology) but cases of recurrent HSV-associated erythema multiforme can be prevented by prophylactic use of acyclovir. Some cases of idiopathic recurrent erythema multiforme (i.e. where antecedent herpes labialis is not suspected) also respond to prophylactic use of acyclovir. This is perhaps consistent with a preceding 'silent' recurrence of HSV.

DIAGNOSIS

The ability of HSV to establish latent infection inevitably complicates diagnosis. A clinical role for the virus in causation of disease is not established simply because it is recovered from a patient. To achieve *meaningful* diagnosis a close collaboration between clinic and laboratory is always necessary.

Light and UV Microscopy

In diagnostic virology direct light microscopic examination of clinical material is now seldom used to provide a diagnosis of HSV infection but histopathological examination remains an important technique in the differential diagnosis of infection. Rapid detection of HSV in clinical material may be achieved by direct or indirect immunofluorescence (IF) microscopy. Scrapings from vesicles, impression smears or cryostat sections of tissue biopsies provide suitable specimens.

Electron Microscopy

Transmission electron microscopic examination of negatively stained vesicle fluid presents one of the most rapid methods for detection of HSV. The morphology of HSV is characteristic but HSV-1, HSV-2 and VZV cannot be differentiated by such direct examination. The technique is also relatively insensitive and a specimen must contain at least 10^6 or more particles per millilitre to allow detection of virus.

Virus Culture

HSV-1 and HSV-2 are among the easiest of viruses to cultivate and propagate in the laboratory. A wide range of both primary and continuous monolayer cell cultures may be infected with HSV. Cytopathic effect (CPE) develops within 1–7 days of inoculation. Both ballooning degenerating cells and multinucleate giant cells may be observed. The CPE of HSV-1 and HSV-2 may be rapidly differentiated by immunofluorescence staining of infected cells with type-specific monoclonal antibodies.

Virus isolation in cell culture provides a highly sensitive method for the detection of HSV but its efficiency depends on the method of specimen collection and the preservation of virus infectivity between the patient and the laboratory. Vesicle fluid is usually rich in virus, provided the fluid is collected from a 'fresh' vesicles. Virus is rarely isolated from crusted vesicle. A cotton wool bud is used to swab ulcers or mucous membranes in order to detach virus-containing cells. To reduce loss of infectious virus between the patient and laboratory, the swab is then placed in a suitable transport medium. If there is delay in transportation, the material should be maintained at $+4^{\circ}\text{C}$ or immersed in liquid nitrogen. CSF, biopsy or necropsy specimens are collected into dry sterile containers and require no special transport media. Such specimens should be transported and maintained at $+4^{\circ}\text{C}$; they should not be frozen. On arrival in the laboratory, they are inoculated on to at least two different cell types. Biopsy or necropsy specimens are homogenized in a small amount of transport medium prior to their inoculation on to cell cultures. As for human cytomegalovirus (DEAFF test), detection of virus growth in tissue culture can be accelerated if speci-

mens are centrifuged on to cells cultivated on small cover slips and the cells are stained after 24 h with a monoclonal antibody directed to HSV early antigen.

Immunoassay

A number of ELISA procedures are available for rapid detection of HSV. While the specificity of these procedures is high (c. 98%), their sensitivity for the detection of virus in acute vesicular lesions is only about 80%, and with material from crusting lesions may reduce to less than 60%. While culture provides at present the optimum method for the detection of virus in acute lesions, as immunoassay can detect non-infectious virus (i.e. virus antigens); immunoassays can offer advantage where suboptimal transportation of specimens to the laboratory has resulted in loss of virus infectivity.

Nucleic Acid Detection

Direct hybridization of clinical samples with radio- or enzyme-labelled oligonucleotides has been used for the direct detection of viral nucleic acid (dot-blot or slot-blot hybridization). Since the widespread introduction of nucleic acid amplification techniques such as the PCR, this technique is seldom used. While there are several competing technologies involving either target (e.g. NASBATM) or signal (bDNATM) amplification, PCR is at present the principal method of nucleic acid amplification applied in diagnosis of HSV infection.

Polymerase Chain Reaction

In some situations there is insufficient virus present in the available clinical specimen to allow diagnosis by antigen detection or culture. The most clear-cut example is in the acute stage diagnosis of herpes encephalitis by detection of HSV DNA in CSF. Numerous studies have demonstrated that in the acute stages of the illness the detection of HSV DNA in CSF has a sensitivity of 95–100% and a specificity of 97–100%, making this procedure the most sensitive and specific neurological test described (Cinque *et al.*, 1996). Application of PCR to the examination of CSF for diagnosis of cases of suspected HSV meningitis has improved radically

the efficiency of diagnosis and has provided evidence which shows that most cases of the recurrent meningitis—Mollaret's meningitis—are due to HSV-2 (Linde *et al.*, 1997). PCR is also valuable in investigation of infants with suspected neonatal herpes where cultures have been negative (Koskiniemi *et al.*, 1998), and in the investigation of intraocular infection.

The sensitivity, specificity and speed (5–24 h) of diagnosis afforded by PCR make it attractive as a universal method of diagnosis. However, while the method is simple in concept there remain many practical difficulties. Rigorous quality control and attention to detail are essential for routine application of the technique. Many types of clinical samples contain substances that prove inhibitory to the PCR reaction, which, if not removed efficiently, will result in the production of false-negative test results. There is variation between different PCR protocols in relation to their sensitivity to inhibitors. When using CSF, many of the PCR protocols described to date require sample volumes of only a few microlitres of CSF, with freezing, thawing and boiling as the only method of sample preparation. In other protocols, to achieve sufficient sensitivity and to remove PCR inhibitors, DNA is extracted from CSF. It is also now possible to incorporate internal control molecules in the PCR test, a development which allows the monitoring of possible sample-induced PCR inhibition and also the quantitation of the virus DNA present in a clinical sample (Revello *et al.*, 1997). Virus, and virus type, specific primers have been commonly used. Some methods utilize single PCR (sPCR), in which the DNA sequence is amplified during one sequence of thermal cycling. In others, two sets of primers and two thermal cycling sequences are used; nested PCR (nPCR). The nPCR methods may be more sensitive than sPCR, but application of postamplification amplicon detection methods, such as oligonucleotide hybridization using a probe sequence homologous to a region of HSV DNA internal to the primer binding sites and ELISA-like detection of hybrids, allow sPCR to achieve comparable levels of sensitivity.

The contamination of samples, both inside and outside the laboratory, with virus or amplicons may give rise to false-positive PCR results. This represents a significant practical problem and requires careful consideration in the design of PCR protocols. The larger number of technical manipulations

associated with nPCR may more easily lead to contamination than sPCR. The relative complexity of DNA extraction procedures in different PCR protocols may also increase the risk of contamination but with careful design and attention to detail many such problems can be avoided. A particular consideration in herpesvirus PCR is the possible detection of DNA from (asymptomatic) recurrent herpesvirus infections. This may create difficulties in defining the clinical significance of a test result.

In Situ Hybridization and In Situ PCR

HSV nucleic acids may be detected in biopsy or necropsy material by *in situ* hybridization. Paraffin-embedded tissue sections are dewaxed and rehydrated and digested with proteinase K. After a denaturing step, a labelled DNA fragment or 'probe' (an oligonucleotide produced synthetically or a cloned (plasmid amplified) fragment of HSV DNA) is incubated with the tissue section. The section is then washed to remove non-hybridized probe DNA. The probe may be labelled radioisotopically, in which case specific hybridization is revealed by autoradiography. Non-isotopic methods employ enzymes, biotin (together with avidin/enzyme), di-oxygenin (with an antideoxygenin-antibody/enzyme) or chemiluminescent labels where specific hybridization is revealed by application of a chromogenic substrate. Modifications of the basic methodology allow the detection of mRNA, thereby allowing distinction between replicating and latent virus. Methods for *in situ* specific nucleic acid amplification using polymerase chain reaction (*in situ* PCR) are also available and are valuable where only very small amounts of viral DNA are present in the clinical sample. Unfortunately, the technical complexity of the latter techniques restricts their usage.

Serology

Peripheral Blood

A large number of techniques are available to detect and quantitate the humoral immune response to HSV infection, including complement fixation tests (CFTs), immunofluorescence tests and tests for neutralizing antibody. Differences in specificity and in sensitivity are observed between the different tech-

niques and different assays. In most clinical laboratories CFT has been replaced by commercially available ELISA tests. In clinical situations assay of HSV-specific IgG antibody is usually sufficient. In primary infection seroconversion is readily detected in adequately spaced samples (14 or more days). In a primary infection IgG production can be detected at around the same time as an IgM response. Differentiation of primary and reactivated infection may be possible by measurement of HSV-specific IgG avidity. In recent infection IgG avidity will be low, while in reactivated infection IgG avidity will usually be high.

IgM antibody to HSV can be detected using a suitable enzyme-labelled antiglobulin in the standard indirect ELISA technique. Unfortunately, false-negative results are possible where IgG HSV antibody competes for the limited amount of viral antigen available on the immunosorbent (the binding of the smaller IgG molecule being kinetically favoured over that of the larger IgG molecule). To circumvent this problem, IgM 'capture' immunoassay can be used. The detection of IgM antibody does not allow differentiation of a primary infection and a reactivation event. During reactivation an IgM response can often be detected. The magnitude of the response can vary from individual to individual and from reactivation event to reactivation event. The clinical uses of HSV IgM assays are therefore limited. They may be of value in evaluating immunocompromised patients and are certainly of value in diagnosis of neonatal HSV infection, where in some cases an IgM response to HSV is the only serological response detectable.

The type-common epitopes of HSV-1 and HSV-2 ensure that most conventional ELISA techniques are adequate for the detection of seroconversion to either virus. Cross-reaction with VZV can occur and interpretation of results in reactivation may be difficult because there is sometimes evidence of parallel increases in HSV and VZV antibody, either because of an anamnestic immune response or possibly because of synchronous reactivation ('dual reactivation') or synchronous infection ('dual infection').

ELISA procedures utilizing whole virus preparations representative of the complete antigenic spectrum of HSV provide the most sensitive assays for HSV antibody. However, to differentiate HSV-1 and HSV-2 serological responses, ELISA procedures using type-specific peptide and/or recom-

binant antigens to distinguish HSV-1-specific and HSV-2-specific antibodies are necessary. Such assays have only become commercially available recently but have potential value in epidemiological studies and in specialized situations, such as determination of the serostatus of the partner of a newly diagnosed case of genital herpes. In general, these assays are of lower sensitivity than assays employing whole virus antigens, as they detect only a subset of the total humoral immune response to the virus (i.e. antibodies to cross-reactive epitopes—the majority of HSV antigens—are not detected by these assays). Their use in the diagnosis of acute infection is thus limited.

Cerebrospinal Fluid

Demonstration of a peripheral blood HSV antibody response is not in itself diagnostic of CNS infection. Such a response may merely reflect reactivation of latent HSV secondary to neurological disease of unrelated aetiology. Detection of HSV IgM in HSV IgG-negative patients, or in patients with very low levels of specific HSV IgG, is suggestive of a primary infection, although false-positive IgM reactions are known to occur, making follow-up serology necessary.

Serological diagnosis of CNS infection requires proof of intrathecal synthesis of specific antibody. To determine whether specific antibodies are produced intrathecally, and not transferred passively from serum, the integrity of the blood-CSF barrier must be assessed. A variety of methods are available (Linde *et al.*, 1997). The most accurate are believed to be those in which the ratio of antibody quantitated in both serum and CSF are compared to the distribution of a reference protein such as albumin, or, where antigen-mediated capillary blotting is performed, after isoelectric focusing of serum and unconcentrated CSF (Monteyne *et al.*, 1997).

In the former technique, the most reliable of several formulae applied to determine intrathecal synthesis was determined to be that of Reiber (1994). Here, locally produced IgG is differentiated from polyclonal IgG derived from peripheral blood circulation by dividing the unit ratio by Q_{Lim} (Q_{Lim} representing the fraction of antibody in CSF originating from serum, i.e. $Q_{Lim} = 0.93((QA_{lb} + 6 \times 10^6) - 1.7 \times 10^3)$. Q_{Lim} can be estimated for IgG, IgM and IgA using Reiber's diagrams (Reiber, 1994).

The antigen-mediated capillary blot technique, performed after isoelectric focusing of serum and unconcentrated CSF, provides an alternative and sensitive method for the detection of specific intrathecal synthesis of antibody. The presence of two or more anti-HSV oligoclonal IgG bands present only in CSF is considered to provide a definite diagnosis.

Cell-Mediated Immunity

The cell-mediated immune response is of major importance in the control of, and recovery from, HSV infection. However, current studies of CMI are at present restricted to the *investigation* of HSV disease rather than the *diagnosis* of infection. Biological assays of lymphokines have been replaced by more specific immunoassays; monoclonal antibodies provide reagents for the identification of particular cell types; and molecular biological techniques provide purified HSV proteins to allow precise identification of virus and host immune interactions. A growing number of the individual components of the immune response may now be identified and quantified (e.g. interferons and interleukins) and the cell types participating in the inflammatory response to infection can be determined.

MANAGEMENT

Outside the natural host, HSV has only a short half-life and is inactivated readily by a variety of physical and chemical agents, including detergents, common disinfectants (phenolics, formaldehyde, glutaraldehyde, hypochlorite, quaternary ammonium compounds) and solvents (e.g. 70% alcohol). Standard methods of sterilization, including autoclaving, dry heat, UV or gamma irradiation, and ethylene oxide sterilization are all equally effective for the decontamination of medical equipment. In the controlled environment of a hospital, prevention of host-to-host transmission is achieved by simple hygiene. In the home, or other social contexts, prevention of transmission by avoidance of contact with a person with evidence of recurrent infection (cold sores or genital herpes) is only partially effective. This is because infectious virus is often excreted before the appearance of overt symp-

toms of recurrent infection and 'silent' recurrent infections also occur.

Antiviral Chemotherapy

A large number of compounds with anti-HSV activity have been described in *in vitro* experiments. Few have progressed to clinical trial and fewer still have gained a place in clinical practice. The major 'anti-herpetic' in current use is acyclovir, although newer antivirals such as penciclovir or the prodrugs of acyclovir and penciclovir, valaciclovir and famciclovir, offering better systemic bioavailability following oral administration, are being brought into use.

Acyclovir (ZoviraxTM)

The structure of acyclovir is shown in Figure 2A.5a. The compound is an acyclic nucleoside analogue. The mode of action of acyclovir is illustrated in Figure 2A.6. Virus-infected cells appear to be slightly more permeable to acyclovir than non-infected cells but the compound is only entrapped and selectively concentrated within virus-infected cells. Within the infected cell, a virus-specified enzyme, thymidine kinase, effects the monophosphorylation of acyclovir. The resulting acyclovir monophosphate cannot traverse cellular membranes and is consequently localized within the virus-infected cell. Host cell kinases (including host cell-derived thymidine kinase) do not appear capable of catalysing this reaction to any significant degree.

The active antiviral drug is acyclovir triphosphate and conversion of acyclovir monophosphate to the active triphosphate form is accomplished by host cell kinases. The triphosphate form of acyclovir has much greater affinity for virus-specified, as opposed to host cell-derived, DNA polymerase. Acyclovir triphosphate binds to host-derived DNA polymerase, leading to the inactivation of this enzyme's activity. Thus, viral DNA replication is inhibited, while normal host cell DNA metabolism remains virtually unaffected. An additional but less significant antiviral action is via chain termination through incorporation into the growing viral DNA chain (absence of 2' and 3' carbons of guanosine).

Prolonged use of acyclovir can result in the development of drug-resistant strains of HSV. Thymidine kinase mutants have been reported with

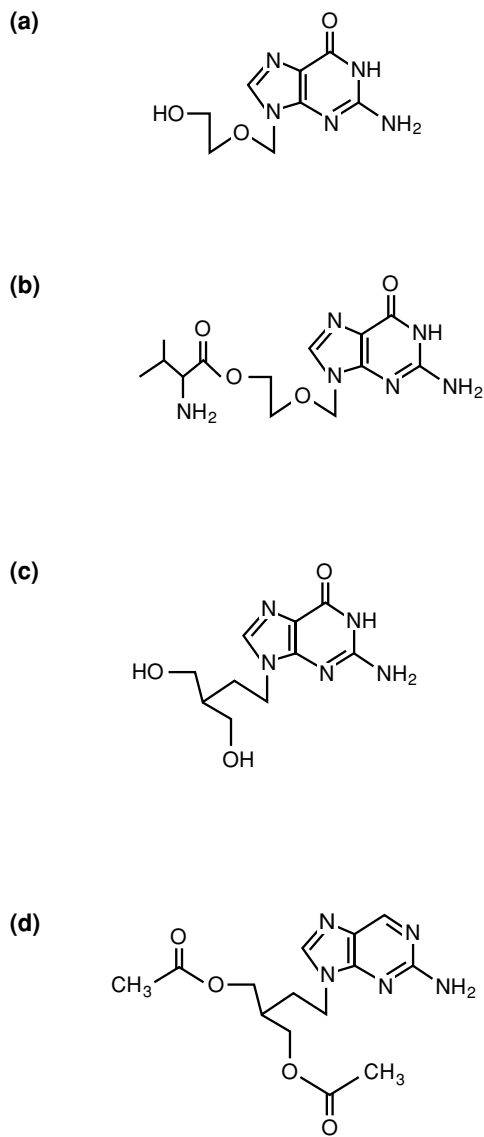

Figure 2A.5 Antiviral drugs. (a) Acyclovir: 2-amino-1,9-dihydro-9-[(2-hydroxyethoxy)methyl]-6H-purin-6-one (mol. wt 225.21). (b) Valaciclovir: L-valine, 2-[(2-amino-1,6-dihydro-6-oxo-9H-purin-9-yl)methoxy]ethyl ester, monohydrochloride (mol. wt 360.80). (c) Penciclovir: 9-[4-hydroxy-3-(hydroxymethyl)butyl] guanine (mol. wt 253.26). (d) Famciclovir: 2-[2-(2-amino-9H-purin-9-yl)-1,3-propanediol]-acetate (mol. wt 321.3)

either altered substrate specificity (i.e. acyclovir is no longer recognized as a substrate for virus specified enzyme) or with loss of thymidine kinase (TK) activity—the latter group being of lesser importance because loss of TK activity is associated with

reduction of virulence. These mutants arise through point mutation in the TK gene and are thus readily generated both *in vivo* and *in vitro*. A third type of mutant has altered DNA polymerase such that acyclovir triphosphate no longer binds, with high affinity, to the virus-encoded enzyme (altered substrate specificity). The consequence of alteration in TK is a failure of the virus-infected cell to phosphorylate and thereby selectively concentrate acyclovir. Alteration in DNA polymerase results in a much reduced antiviral activity because the only antiviral action of the drug resides in the ability of acyclovir triphosphate to induce chain termination.

The emergence of drug resistance gives rise to concern, but thus far drug resistance has not become a widespread problem. It is usually only seen in individual patients undergoing long-term acyclovir prophylaxis. Most acyclovir-resistant strains of virus are also found to be resistant to penciclovir (see below).

Valaciclovir (Valtrex™, Zelitrex™)

The oral bioavailability of acyclovir is relatively low and for this reason a prodrug ester of acyclovir—valaciclovir—was developed (Figure 2A.5b). Valaciclovir hydrochloride is rapidly adsorbed from the gastrointestinal tract and rapidly and almost completely converted to acyclovir and L-valine by first-pass intestinal and/or hepatic metabolism. The mode of action and clinical spectrum of activity of valaciclovir is identical to that of acyclovir. The plasma concentrations of acyclovir achieved after oral administration of valaciclovir are believed to be equivalent to those achieved by intravenous administration of acyclovir and are 3–5 fold greater than are achieved with oral administration of acyclovir.

Penciclovir (Denavir™)

Penciclovir is an acyclic nucleoside analogue (Figure 2A.5c) whose mode of action is essentially identical to that of acyclovir. However, the half-life of the active antiviral (penciclovir triphosphate) is substantially longer than that of acyclovir triphosphate. *In vitro* experiments the half-life of penciclovir triphosphate in HSV-1-infected cells is about 10 h, and in HSV-2 infected cells is about 20 h.

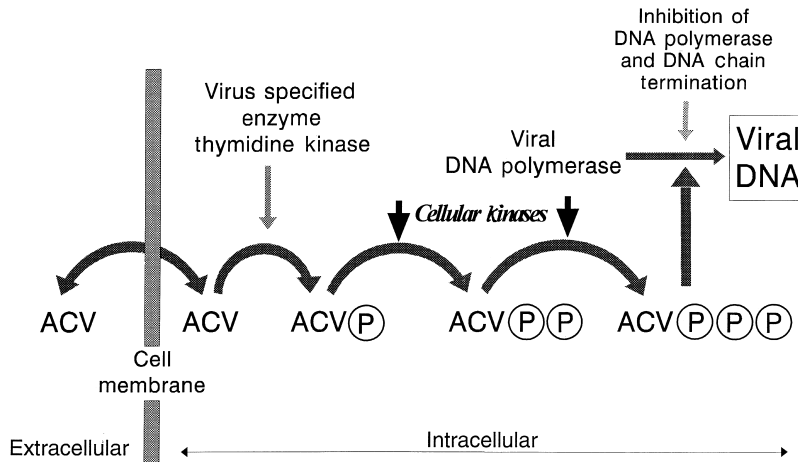

Figure 2A.6 Acyclovir: mode of action

Famciclovir (Famvir™)

Famciclovir (Figure 2A.5d) is the diacetyl 6-deoxy prodrug of penciclovir. Famciclovir achieves high levels of systemic bioavailability following oral administration. Following administration the drug is deacetylated and oxidized to form penciclovir. The mode of action and clinical spectrum of activity is thus identical to that of penciclovir.

Other Antivirals

A number of other antiviral compounds show anti-HSV activity and may be used when antiviral drug resistance is suspected. Examples are foscarnet (trisodium phosphonoformate), a pyrophosphate analogue and thus an inhibitor of DNA polymerase and ganciclovir ([9-(1,3-dihydroxy-2-propoxy)methyl] guanine)—a further acyclic nucleoside analogue which inhibits DNA polymerase but lacks the selectivity of acyclovir or penciclovir, as the conversion of ganciclovir to ganciclovir monophosphate is not dependent upon virus-specified TK.

Immunization

Active Immunization

The short time interval between loss of passively acquired maternal immunity and acquisition of primary infection, together with the high level of HSV

infection in the general population, means that effective prevention of HSV-1 infection by vaccination is problematic. Immunization against HSV-2 infection is possibly a more attainable goal. The currently available epidemiological data suggest that there is more time between birth and acquisition of primary or initial HSV-2 infection for a vaccine to be administered. At the present time, two strategies are being investigated: classical immunization to promote host immunity prior to virus exposure; and a novel (and unproven) strategy—modification of the immune response by vaccine administration designed to potentiate immunity and improve control of, or prevent, recurrent infection.

In the past, the use of attenuated 'live virus' vaccines has been approached with extreme caution because of the possibility of establishing latent infection and subsequently recurrent infection. Currently a replication-disabled 'live virus' vaccine, several 'subunit' vaccines using viral proteins produced by recombinant technology, peptide vaccines and, most novelly, bacterial plasmid DNA with fragments of viral DNA encoding viral antigens, are in various stages of clinical and preclinical trial.

Passive immunization

Passive immunization using hyperimmune HSV-specific immunoglobulin has not been widely utilized. In neonatal disease, and possibly in immunocompromised patients, trials of therapy using hu-

man recombinant monoclonal antibodies are planned, as such therapy might have a role in helping to prevent virus dissemination by viraemia.

Specific Management

Primary or Initial Infection

Primary or initial infection with HSV is, in the majority of cases, inapparent or only associated with mild symptoms, and therapeutic intervention is not considered. For symptomatic infection, management is tailored to the severity of symptoms. Bicarbonate- or chlorhexidine-containing mouthwashes combined with simple analgesia may be adequate in gingivostomatitis. Saline douches may provide relief from herpes vaginitis. Severe cases merit the introduction of specific antiviral chemotherapy. Acyclovir and penciclovir creams are available for direct application to skin lesions; however, a more effective treatment is oral administration of acyclovir (given in 250 mg doses five times daily), valaciclovir (1 g per day) or famciclovir (250 mg three times daily) for 5–10 days. There is some evidence that antiviral treatment of primary or initial infections may impact upon the subsequent frequency of reactivation. Severe primary or initial infections are associated with a higher frequency of (symptomatic) reactivation.

Secondary bacterial and fungal infection is common in severe symptomatic primary and initial HSV infection and requires appropriate antimicrobial therapy.

Steroid treatment in general increases the severity of disease and, where patients are receiving high doses of steroids (e.g. in treatment of eczema), the appearance of HSV infection is an indication for temporary cessation or reduction of steroid dosage. In other cases of iatrogenic immunosuppression (e.g. for organ transplantation), HSV infection is an indicator for temporary reassessment of the dosage of the immunosuppressive therapy. Primary HSV infection in the immunocompromised host always gives cause for concern because of the possibility of the development of generalized multiorgan infection. Serious HSV infections require not only the prompt initiation of specific antiviral chemotherapy but also full medical and nursing intervention. Generalized infection in the immunocompromised produces osmotic imbalances, endocrine dysfunction,

and circulatory and respiratory failure which necessitate an aggressive approach to intensive care.

Recurrent Infection

Recurrent HSV infections inconvenience the host but are rarely serious in the immunocompetent individual. Patients with only occasional recurrences often develop their own preferred self-treatment; for example, the dabbing of perfume or alcohol on cold sores, or the use of acyclovir cream. Frequent or severe recurrences may require oral or systemic antiviral chemotherapy. The most effective episodic treatment requires a 5 day course of oral antiviral therapy initiated as soon as prodromal symptoms are observed. Acyclovir (200 mg 5 times daily), famciclovir (125 mg twice daily) or valaciclovir (500 mg twice daily) can be used. In a recurrent episode, the earlier the treatment is started the more effective it proves in reducing the severity and duration of the recurrent episode.

Since the maintenance of latent virus infection appears to be independent of virus replication, antiviral chemotherapy cannot 'cure' recurrent virus infection. Patients with frequent recurrences should, however, be considered for continuous suppressive therapy; acyclovir (400 mg twice daily 200 mg p.o. 3–5 times a day), valaciclovir (500 mg twice daily) or famciclovir (125 mg twice daily) are believed to be effective. Usually a 6–12 month period is chosen for continuous therapy and the necessity for therapy is then reassessed.

Ocular Infection

The majority of cases of ocular HSV infection are thought to result from an endogenous reinfection (i.e. transfer of virus from the site of a recurrent infection to the eye). Misdiagnosis of the condition has led frequently to the administration of corticosteroids to the eye. Unfortunately such treatment may exacerbate and prolong the infection. Endogenous reinfections or primary infections of the eye should not be treated with steroids. Conservative treatment is warranted, with application of specific antiviral chemotherapy (acyclovir ophthalmic ointment) and possibly debridement of the cornea. Oral or systemic antiviral therapy (see above) should be given in severe disease. Secondary bacterial infection may occur, necessitating appropriate

antimicrobial therapy. Recurrent ocular HSV infections are managed in a similar fashion except that the indication for antiviral chemotherapy is more pronounced.

The treatment of the late stage of herpetic eye disease (stromal involvement) is more controversial, in that some authors believe that antiviral treatment may accentuate rather than alleviate stromal disease. Steroid therapy is almost certainly indicated in stromal herpes keratitis and possibly also in iridocyclitis, as most damage is believed to result from an inflammatory reaction rather than the direct action of virus replication in corneal tissues. Severe stromal scarring necessitates corneal transplantation.

CNS Infection

Treatment of herpes encephalitis requires the early administration of antiviral chemotherapy (Cinque *et al.*, 1996). Antiviral chemotherapy should also be given in herpes meningitis, as the sequelae of this infection are not defined but do include the possible development of recurrent meningitis. The currently accepted antiviral treatment for herpes encephalitis is a 10 day intravenous course of acyclovir at 10 mg kg⁻¹ given every 8 hours. Acyclovir therapy should be approached with caution in patients with impaired renal function because build-up of excessive serum concentrations of acyclovir has been associated with (reversible) neurotoxicity.

Specific antiviral chemotherapy is not the only important factor in treatment of CNS infection. Brain oedema is believed to be the major cause of mortality in herpes encephalitis, hence reduction in intracranial pressure is an important consideration in the overall treatment regimen and necessitates careful management in close collaboration with the clinical virology laboratory (Cinque *et al.*, 1996).

Neonatal Infection

HSV-1 and HSV-2 can both cause neonatal infections. In general, type 1 infection poses a relatively low risk for long-term sequelae in the child, type 2 high, although these associations are not absolute and type 1 infection may cause fatal disease. Primary maternal genital infection appears to pose the greatest threat to the neonate, although recurrent maternal infection is also a risk. In the large majority of cases the mother may have no genital lesions

at the time of delivery. Prediction of infection by routine cultures performed during pregnancy is not possible and caesarean section in prevention of infection is of doubtful benefit and should not be reserved only for those with known primary or ongoing recurrent infection within the birth canal at the time of delivery. Where vaginal delivery cannot be avoided, intravenous administration of acyclovir to both mother and infant are probably appropriate (Smith *et al.*, 1998).

Antiviral therapy for HSV must be administered to the neonate early in the course of the disease before irreversible damage occurs. In at least 50% of cases the child and the mother lack apparent lesions and the majority of mothers have no history of genital herpes. Recurrence of herpetic lesions or relapse of neurological or retinal disease is unfortunately frequent in infants with neonatal herpes who have received a course of parenteral acyclovir. Treatment of neonatal herpes using increased dosages of acyclovir and prolonged (21 days) intravenous therapy has been attempted on an empirical basis. Prolonged oral administration of acyclovir has also been utilized, although at present there is no evidence from appropriately controlled studies to confirm or refute the benefit of either of these strategies.

REFERENCES

- Bergstrom, T. and Trybala, E. (1996) Antigenic differences between HSV-1 and HSV-2 glycoproteins and their importance for type-specific serology. *Immunology*, **39**, 176–184.
- Burnet, F.M. and Williams, S.W. (1939) Herpes simplex: a new point of view. *Medical Journal of Australia*, **1**, 637–641.
- Chou, J. and Roizman, B. (1994) Herpes simplex virus 1 γ 34.5 gene function which blocks the host response to infection maps in the homologous domain of the genes expressed during growth arrest and DNA damage. *Proceedings of the National Academy of Sciences of the USA*, **91**, 5247–5251.
- Cinque, P., Cleator, G.M., Weber, T. *et al.* (1996) The role of laboratory investigation in the diagnosis and management of patients with suspected herpes encephalitis: a consensus report. *Journal of Neurology Neurosurgery and Psychiatry*, **61**, 339–345.
- Damasio, A.R. and Van Hoesen, G.W. (1985) The limbic system and the localisation of herpes simplex encephalitis. *Journal of Neurology, Neurosurgery and Psychiatry*, **48**, 297–301.
- Esiri, M.M. (1982) Herpes simplex encephalitis: an immunohistological study of the distribution of viral antigen within the brain. *Journal of the Neurological Sciences*, **54**, 209–226.
- Ho, D.Y. (1992) Herpes simplex virus latency: molecular aspects. *Progress in Medical Virology*, **39**, 76–115.

- Jerne, N.K. (1976) The immune system: A web of v-domains. *Harvey Lectures*, **70**, 93–110.
- Koskiniemi, M., Klapper, P.E., Forsgren, M. *et al.* (1999) Laboratory diagnosis of neonatal CNS infections: a consensus from the European Union Concerted Action on Virus Meningitis and Encephalitis. (submitted for publication)
- Latchman, D.S. (1996) Transcriptional regulation of herpes simplex virus gene expression: implications for our understanding of latency. In *Protocols for Gene Transfer in Neuroscience: Towards Gene Therapy of Neurological Disorders* (eds P.R. Lowenstein and L.W. Enquist), pp 131–139. Wiley, Chichester.
- Linde, A., Klapper, P.E., Monteyne, P. *et al.* (1997) Specific diagnostic methods for herpesvirus infections of the central nervous system: a consensus review by the European Union Concerted Action on Virus Meningitis and Encephalitis. *Clinical and Diagnostic Virology*, **8**, 83–104.
- Lycke, E., Hamark, B., Johansson, M. *et al.* (1988) Herpes simplex infection of the human sensory neuron. An electron microscope study. *Archives of Virology*, **101**, 87–104.
- McGeoch, D.J., Dolan, A., Donald, S. *et al.* (1986) Complete DNA sequence of the short repeat region in the genome of herpes simplex virus type 1. *Nucleic Acids Research*, **14**, 1727–1745.
- McGeoch, D.J., Dalrymple, M.A., Davison, A.J. *et al.* (1988) The complete DNA sequence of the long unique region in the genome of herpes simplex virus type 1. *Journal of General Virology*, **69**, 1531–1574.
- Monteyne, P., Albert, F., Weissbrich, B. *et al.* and the EU Concerted Action on Virus Meningitis and Encephalitis (1997) The detection of intrathecal synthesis of anti-herpes simplex IgG antibodies: comparison between an antigen-mediated immunoblotting technique and antibody index calculations. *Journal of Medical Virology*, **53**, 324–331.
- Reiber, H. (1994) Flow rate of cerebrospinal fluid (CSF): a concept common to normal blood–CSF barrier function and to dysfunction in neurological diseases. *Journal of the Neurological Sciences*, **122**, 189–203.
- Revello, M.G., Baldanti, F., Sarasini, A. *et al.* (1997) Quantitation of herpes simplex virus DNA in cerebrospinal fluid of patients with herpes simplex encephalitis by the polymerase chain reaction. *Clinical and Diagnostic Virology*, **34**, 39–50.
- Roizman, B. and Sears, A.E. (1996) Herpes simplex viruses and their replication. In *Fields Virology* (eds B.N. Fields, D.M. Knipe, P.M. Howley *et al.*), pp. 2231–2295. Lippincott-Raven, Philadelphia.
- Sears, A.E. and Roizman, B. (1990) Amplification by host factors of a sequence contained within the herpes simplex virus 1 genome. *Proceedings of the National Academy of Sciences of the USA*, **87**, 9441–9445.
- Smith, J.R., Cowan, F.M. and Munday, P. (1998) The management of herpes simplex virus infection in pregnancy. *British Journal of Obstetrics and Gynaecology*, **105**, 255–260.
- Stannard, L.M., Fuller, A.O. and Spear, P.G. (1987) Herpes simplex virus glycoproteins associated with different morphological entities projecting from the virion envelope. *Journal of General Virology*, **68**, 715–725.
- Tookey, P. and Peckham, C.S. (1996) Neonatal herpes simplex virus infection in the British Isles. *Paediatric and Perinatal Epidemiology*, **10**, 432–442.
- Whitley, R.J. (1990) Herpes simplex viruses. In *Fields Virology* (eds B.N. Fields and D.M. Knipe), 1843–1888. Raven Press, New York.
- Whitley, R.J. (1993) Neonatal herpes simplex virus infections. *Journal of Medical Virology*, **suppl. 1**, 13–21.
- York, I.A., Roop, C., Andrews, D.W. *et al.* (1994) A cytosolic herpes simplex virus protein inhibits antigen presentation to CD8 + T lymphocytes. *Cell*, **77**, 525–535.
- Zhou, Z.H., Prasad, B.V.V., Jakana, J. *et al.* (1994) Protein subunit structures in the herpes simplex virus A-capsid determined from 400kV spot-scan cryomicroscopy. *Journal of Molecular Biology*, **242**, 458–469.
- Zhou, Z.H., He, J., Jakana, J. *et al.* (1995) Assembly of VP26 in HSV-1 inferred from structures of wild-type and recombinant capsids. *Nature Structural Biology*, **2**, 1026–1030.

Varicella Zoster

Judith Breuer, David R. Harper and Hillar O. Kangro

St Bartholomew's and the Royal London School of Medicine and Dentistry, London, UK

INTRODUCTION

Two common diseases are caused by *Varicella zoster virus* (VZV): chickenpox (varicella) and shingles (herpes zoster). Nobody appears to know for sure what the word 'chicken' has to do with chickenpox but one possible derivation of the term 'chickenpox' is from the Old English 'gican' (itch) designating it the 'itchy' pox to differentiate it from diseases such as smallpox. The words 'zoster' and 'shingles' are derived respectively from Greek and Latin words meaning a belt or girdle and are obviously descriptive of the characteristic distribution of the rash.

Chickenpox is the manifestation of primary infection with VZV and is one of the commonest communicable diseases worldwide. Its characteristic presentation in the majority of cases is as familiar to laymen as it is to doctors and is usually of little concern to either. However, it has also been long recognized that chickenpox can have serious consequences in adults and in immunosuppressed individuals. Shingles is the manifestation of recurrent VZV infection and, although rarely a life-threatening disease, it is perhaps of more concern community-wide because of the pain, not only of the acute lesion but also of the frequent postherpetic neuralgia, which can be very debilitating and is notoriously difficult to treat.

The common aetiology of varicella and herpes zoster was first recognized at the beginning of the century by clinicians who noticed that a case of zoster in a household was often followed by an

outbreak of varicella in the younger members of the family and their friends. Furthermore, it was shown that vesicle fluid taken from cases of herpes zoster could induce chickenpox when inoculated into young volunteers. Virus particles were first observed in vesicle fluids by electron microscopy in 1943 and definitive evidence that the two diseases are due to the same virus came with the isolation of the virus in cell culture by Weller in 1953 (Weller *et al.*, 1958). It has now been confirmed by analysis of viral DNA in sequential isolates from the same individual that the same virus causes varicella, upon primary infection, and later causes zoster as a manifestation of reactivation.

There is currently considerable interest in VZV infections, which stems partly from the increasing problems encountered with these infections and partly from the recent advances in prevention and treatment. It is likely that the medical significance of VZV infections will continue to increase in industrialized countries as a direct result of demographic changes in the population. The size of the aged population is increasing, which will result in increasing incidence of herpes zoster. The success of treatment regimens which are immunosuppressive in the fields of oncology and transplantation surgery, as well as the increasing numbers of individuals who are infected with HIV, are creating an ever-increasing number of patients who are at risk of contracting the severe forms of varicella and herpes zoster. At the same time, there is now the distinct possibility of the wider use of vaccines in the community to prevent varicella.

Capsid Three forms exist: A (empty), B (intermediate) and C (mature). Assembly proteins present in the B form are lost during DNA insertion to produce the C form.

Tegument A complex mass of proteins surrounding the capsid. Contains enzymes controlling virus replication and regulating cell function.

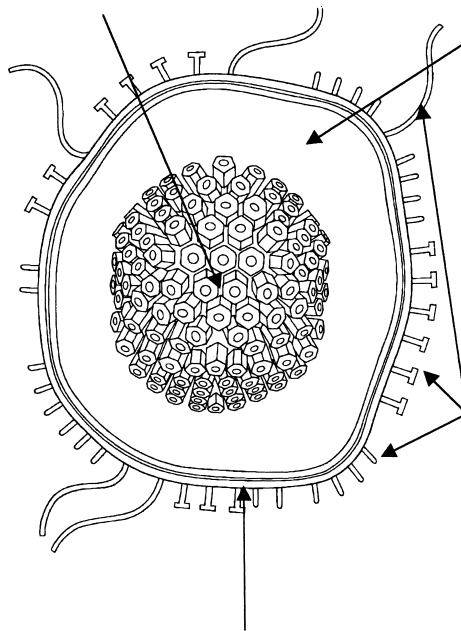

Glycoprotein 'spikes'
Glycoproteins gE, gB, gH, gI, gC and gL project through the lipid envelope allowing the virus to interact with its environment. gE/gI and gH/gL are present as complexes.

Envelope A complex membranous structure derived from cellular membranes of the trans-Golgi network

Figure 2B.1 Structure of the VZV particle (virion). When intact, the particle is spherical and approximately 200 nm in diameter. Amorphous forms may be seen using traditional electron microscopy. (From *The Sourcebook of Medical Illustration*. Parthenon Press)

THE VIRUS

Structure

Varicella zoster virus has the characteristic morphological appearance of a herpesvirus (Figure 2.B.1), which has been described in detail in Chapter 2A. However, because VZV is quite difficult to grow and particularly difficult to purify, less is known about its proteins and genome organization than is known about those of herpes simplex virus (HSV). In fact much of the knowledge about VZV has been obtained by drawing parallels from HSV. Nonetheless, the recent years have seen major advances in the understanding of VZV at the molecular level. The complete DNA sequence of VZV was published in 1986 by Davison and Scott. A general review of the molecular biology of VZV is given by Davison (1991).

The genome is a linear double-stranded DNA molecule with a molecular weight of 80×10^6 (approximately 125 kb) and, thus, amongst the smallest of all herpesviruses studied. Buoyant density estimations, as well as the sequence data, show a (G + C) content of 46%, which is much lower than most herpesviruses: for example, 67% in herpes simplex 1 (HSV) and 58% in cytomegalovirus (CMV) DNA. Within the genome there are, however, (G + C)-rich regions, notably the repeat regions. The organization of the VZV genome (summarized in Figure 2B.2) shows distinct similarities with HSV DNA and the two viruses have sufficient sequence homology to permit hybridization under non-stringent conditions. However, there is substantial local variation in the extent of this homology, most notably in the almost complete loss of the repeats around the long unique sequence in VZV, which accounts for much of the size difference between the genomes of these two viruses. The similar-

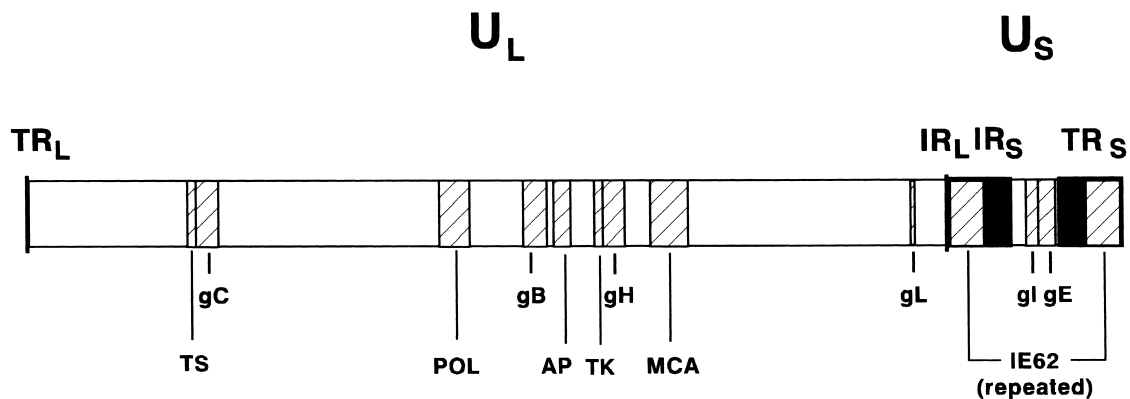

Figure 2B.2 Gene map showing the organization of the VZV genome and the location of genes (hatched) encoding the viral glycoproteins, the major capsid antigen (MCA), the DNA polymerase (POL), the thymidine kinase (TK), the thymidylate synthetase (TS) and the assembly proteinase/protein (AP). The unique long (U_L) and unique short (U_S) regions are identified, as are the terminal repeat (TR_L and TR_S) and inverted repeat regions (IR_L and IR_S). TR_L and IR_L are 88 bp long, while TR_S and IR_S (black boxes) are 7300 bp long

ities between the HSV and VZV genomes would be compatible with a common ancestry, and a model for this has been proposed (Davison and McGeoch, 1986). The VZV genome is divided into two main coding regions: a unique long region (approx. 105000 bp) which is flanked by inverted repeat elements (at 88 bp, far shorter than those of HSV), and a unique short region (approx. 5200 bp), also flanked by inverted repeat sequences (7300 bp). The short region can be found in either of two orientations relative to the long region, producing two isomeric forms of the genome which occur in equal proportion. Inversion of the long region is rare. By contrast, in HSV and CMV both regions invert at equal frequency, resulting in four isomeric forms. An inherent size variation of the genome of approximately 2% (2500 bp) has been demonstrated in clinical isolates, concentrated in five variable regions. Restriction endonuclease cleavage patterns show some DNA polymorphism between clinical isolates, and strain differences in circulating viruses are now becoming apparent which may make such analyses a useful tool in epidemiological studies (see below).

Sixty-nine unique open reading frames (ORFs) have been identified on the VZV genome, of which three are repeated, two are spliced and two are located entirely within other genes. Over 70 different RNA transcripts have been demonstrated in VZV infected cells but the majority of these appear to contain more than one ORF. The genes that have been identified to date account for virtually the whole genome, although the presence of overlap-

ping genes does allow for still further ORFs to be identified. Approximately half of the genes have been, at least tentatively, identified (Table 2B.1)—mostly by analogy with HSV. However, five of the VZV genes, including a gene for a thymidylate synthetase, are not found in HSV, while three HSV genes have no VZV equivalent.

In common with other herpesviruses, the synthesis of VZV proteins broadly involves three phases, designated immediate-early (alpha), early (beta) and late (gamma). More than 30 virus-coded polypeptides can normally be detected in VZV-infected cells, ranging in molecular weight from 7K to over 200K. Among these, at least six groups of glycoproteins can be identified, with molecular weights ranging from 38K to 118K, which correspond to the gene products of VZV glycoproteins E, B, H, I, C and L (Table 2B.2). VZV gE mediates IgG Fc-binding in a complex with VZV gI, while gB is present in virions as a disulphide-linked complex of 140K molecular weight. In addition to the glycoproteins, a range of non-glycosylated proteins have been identified. These include the main protein component of the nucleocapsid (major capsid antigen or MCA, 155K), an assembling proteinase/assembly protein complex produced from gene 33, and the IE62 protein (175K)—an immediate-early translational activator analogous to the HSV ICP4 protein which is present in the virions. Many of the other proteins of VZV are involved in virus replication. These include the thymidine kinase and thymidylate synthetase enzymes, several virus-specified protein kinases, a range of DNA-binding pro-

Table 2B.1 VZV genes for which functional products have been identified

Gene	HSV homologue	Protein identity (%)	Translation product (kDa)	Function
1	No homologue		12.1	Membrane protein
4	U _L 54	29	51.5	Transcriptional activator (IE protein)
6	U _L 52	37	122.5	DNA helicase/primase component
8	U _L 50	25	44.8	Deoxyuridine triphosphatase
9A ^a	U _L 49.5 ^a	Low	9.8	Stearoylated membrane protein
13	No homologue		34.5	Thymidylate synthetase
14	U _L 44	23	61.4	Membrane glycoprotein gC (gpV)
16	U _L 42	21	46.1	Associated with DNA polymerase
17	U _L 41	32	51.4	Host shut-off
18	U _L 40	54	35.4	Ribonucleotide reductase small subunit
19	U _L 39	30	86.8	Ribonucleotide reductase large subunit
28	U _L 30	52	134.0	DNA polymerase
29	U _L 29	50	132.1	Binds single-stranded DNA
31	U _L 27	45	98.1	Membrane glycoprotein gB (gpII)
33	U _L 26	34	66.0	Assembly protease
33.5 ^a	U _L 26.5 ^a	24	32.8	Assembly protein
36	U _L 23	28	37.8	Pyrimidine deoxyribonucleotide kinase
37	U _L 22	25	93.6	Membrane glycoprotein gH (gpIII)
40	U _L 19	52	155.0	Major capsid antigen
47	U _L 13	33	54.3	Protein kinase
48	U _L 12	29	61.3	Deoxyribonuclease
49	U _L 11	26	8.9	Myristoylated protein
51	U _L 9	44	94.4	ori _s binding protein
52	U _L 8	28	86.3	DNA helicase/primase component
55	U _L 5	56	98.8	DNA helicase/primase component
59	U _L 2	39	34.4	Uracil-DNA glycosylase
60	U _L 1	19	17.6	Membrane glycoprotein gL (gpVI)
61	IE110	Local only	50.9	Transcriptional repressor (IE protein)
62/71	IE175	Complex	140.0	Transcriptional activator (IE protein)
63/70	U _s 1	Local only	30.5	Transcriptional activator (IE protein)
66	U _s	33	43.7	Protein kinase
67	U _s 7	23	39.4	Membrane glycoprotein gI (gpIV)
68	U _s 8	22	70.0	Membrane glycoprotein gE (gpI)

^a Internal initiation within previously identified gene.

teins, including the viral DNA polymerase, and five transcriptional regulators produced from ORFs 4, 10, 61–63 (Table 2B.1).

Replication

VZV attaches to the outer membrane of the cell, and this is followed by membrane fusion and entry of the viral core into the cell. This process is mediated primarily by the glycoproteins projecting from the virus particles, although some tegument proteins may also play a role in viral penetration. Attachment is initiated by binding to heparan sulphate proteoglycan on the cell surface. This binding is followed by attachment of mannose 6–phosphate

(M–6–P) oligosaccharides, present on the surface of VZV particles, to M–6–P specific receptors on the host cell (Zhu *et al.*, 1995).

The tegument proteins prepare the cell to produce virus and separate from the nucleocapsid during transportation of virus particles to the nucleus. Once within the the nucleus, the linear DNA genome circularizes.

In common with other herpesviruses, the replication cycle is coordinately regulated. There are three basic stages of gene expression and protein synthesis: immediate early (IE), early (E) and late (L). The first viral proteins (IE) can be detected 4–6 hours post-infection. Structural proteins (L) such as the major capsid protein and viral glycoproteins are not detected until 18 hours post-infection. Viral protein synthesis appears to reach maximum levels

Table 2B.2 VZV

VZV gene	HSV homologue (% protein identity)	Primary transcript (kDa)	Glycosylation pathway (where known)			Mature form (kDa)				
gE (gpI)	gE (22)	73	$\overline{\text{N-linked}}$	81	$\overline{\text{O-linked}}$	90	$\overline{\text{Sialylation}}$	98		
gB (gpII)	gB (45)	100	$\overline{\text{N-linked}}$	126	$\overline{\text{O-linked}}$	130	$\overline{\text{Sialylation}}$ $\overline{\text{Sulphation}}$	140	$\overline{\text{Proteolysis}}$	66, 68
gH (gpIII)	gH (25)	79	$\overline{\text{N-linked}}$			98	$\overline{\text{O-linked}}$	118		
gI (gpIV)	GI (23)	35	$\overline{\hspace{10em}}$					60		
gC (gpV)	gC (23)	58	$\overline{\hspace{10em}}$					100		
gL (gpVI)	gL (18)	18	$\overline{\hspace{10em}}$					20		

at 46–48 hours post-infection in some cell culture systems.

IE transcripts are translated in the cytoplasm and the IE (regulatory) proteins are then transported back into the nucleus where they induce the E gene expression and down-regulate further IE gene transcription. The E proteins include those which are required for VZV DNA replication, such as viral DNA polymerase, viral thymidine kinase and protein kinases. As with the IE proteins, the E proteins are not generally present in the virus particles and are only detected in virus-infected cells.

The L proteins can be subdivided into two categories: the early-late proteins which do not require the synthesis of viral DNA, and the late-late proteins which are dependent on new viral DNA synthesis. DNA synthesis occurs by the movement of the DNA polymerase around the circularized genomic DNA, producing head-to-tail polymers of the viral genome (concatamers). This is referred to as a ‘rolling circle’ mechanism. After translation of late mRNA, the structural proteins that will form the viral capsid are transported back to the nucleus and are assembled around a core of the viral assembly protein. The newly transcribed DNA genome is inserted into the assembled capsid, concurrent with the loss of at least some of the assembly proteins (Harper *et al.*, 1995). Capsids acquire a ‘temporary envelope’ from the inner nuclear membrane and move to the *trans*-Golgi network of membranes (TGN) where the final stages of assembly take place. The nucleocapsid acquires an envelope containing the viral glycoproteins and to which the tegument

proteins are bound. In the normal course of events it appears that a second membrane derived from TGN forms a transport vesicle around the mature virions which then leave the infected cell by a process of exocytosis. In some cells, however, the virions appear to be aberrantly processed and are transported to digestive lysosomes, which possibly accounts for the very low level of cell-free infectious virus found in VZV infected cell cultures (see below).

Growth in Cell Culture

Varicella zoster virus will replicate, with varying degrees of success, in cultures of most cells of human and several of simian origin. Cells from non-primates are generally resistant to infection but the virus has been adapted to embryonic guinea-pig cells and passage in these cells was an early stage of the attenuation of the virus used in the current live vaccines. The behaviour of VZV in cell culture can be regarded as being intermediate between that of HSV, which will grow in nearly all cell cultures, and CMV, which will grow only in few cell types of human origin. In other respects, VZV behaves more like CMV. For example, it grows slowly even in the most sensitive cell systems, with the cytopathic effect (Figure 2B.3) taking from 3 days to over 2 weeks to appear. This process may be mediated by apoptosis rather than direct cell killing. VZV remains even more strongly cell-associated than CMV, and

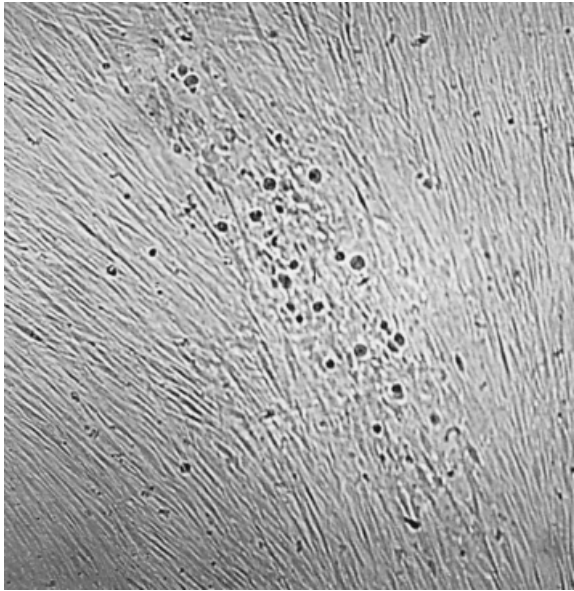

Figure 2B.3 The typical early ovoid cytopathic effect of VZV seen in unstained human embryo lung cells

with most systems passage of virus can be achieved only by transfer of infected cells. Cell-free virus can be obtained by a number of procedures, which typically include sonication of the infected cells. Additionally, protective storage media may be used to increase the yield of infectious virus. Higher yields of infectious cell-free virus can be obtained from the media of infected cultures of human thyroid or malignant melanoma cells, which may reflect the release of a high proportion of defective virus particles in other cell culture systems, as noted above.

The cytopathic effect in most cell systems is so characteristic that no further means of identification may be required. Because of the strong cell association of the virus, the lesion it produces is typically focal and slowly extends into the surrounding cell sheet due to the spread of virus between contiguous cells. Viral antigen can be detected much more rapidly than cytopathic effect. Typically, antigens can be detected in the cytoplasm and nuclei of infected cells within 2–4 hours after infection and in neighbouring cells after 8–18 hours, depending on cell type and the type of antigen targeted. The shape of the lesion is dependent on the architecture of the cell sheet. The typical elongated ovoid shape of the lesion in human embryo lung fibroblasts is shown in Figure 2B.3. Enlarged cells can frequently be seen in the lesion and staining

reveals that these are multinucleated, resulting from virus-induced cell fusion. Staining of the affected cell sheet reveals another feature of VZV cytopathology, namely that many of both the mononuclear and the multinucleated cells have irregularly shaped intranuclear inclusions (Figure 2B.4). With time, the infection ultimately spreads to involve the whole cell sheet.

Strain Variation and Antigenic Properties

The nucleotide diversity of the VZV genome as a whole has been estimated at 0.05%, which is comparable to that of human DNA but may be less than that of HSV (0.2–0.5%). As with all herpesviruses, the VZV genome contains blocks of repeated nucleotide sequences, in this case five (R1–5). R1, R2 and R3 are GC-rich and are located in the coding sequences of genes 11, 44 and 22, respectively. R4, which is present in both of the inverted repeat regions (TR_L and IR_L) flanking the unique long region, and R5 are non-coding. Variation in the number of repeat elements within these regions has been used to distinguish one strain of virus from another, either by means of restriction endonuclease sites generated or lost or by variations in the length of the cleaved fragments (Hawrami *et al.*, 1996). Other restriction sites throughout the genome have also proved useful for typing of clinical isolates. Most notably, a Pst 1 restriction site in gene 38 has been shown to be present in most clinical isolates tested from USA and UK to date but is absent in the Oka vaccine strain. This marker has been used to determine whether cases of chickenpox and zoster following vaccination are due to Oka vaccine virus or wild-type virus. In Japan, approximately 30% of wild type virus isolates do not, like Oka, possess a Pst 1 site and distinguishing them from the vaccine strain requires more extensive typing using other restriction enzymes and the repeat regions.

Only one serological type of VZV is known and thus the diseases it produces may well be preventable with the currently available vaccine. Recent work has shown the existence of a pathogenic VZV strain which has lost a major antigenic epitope on gE, which is the target of a monoclonal antibody often used for diagnostic purposes. Protein differen-

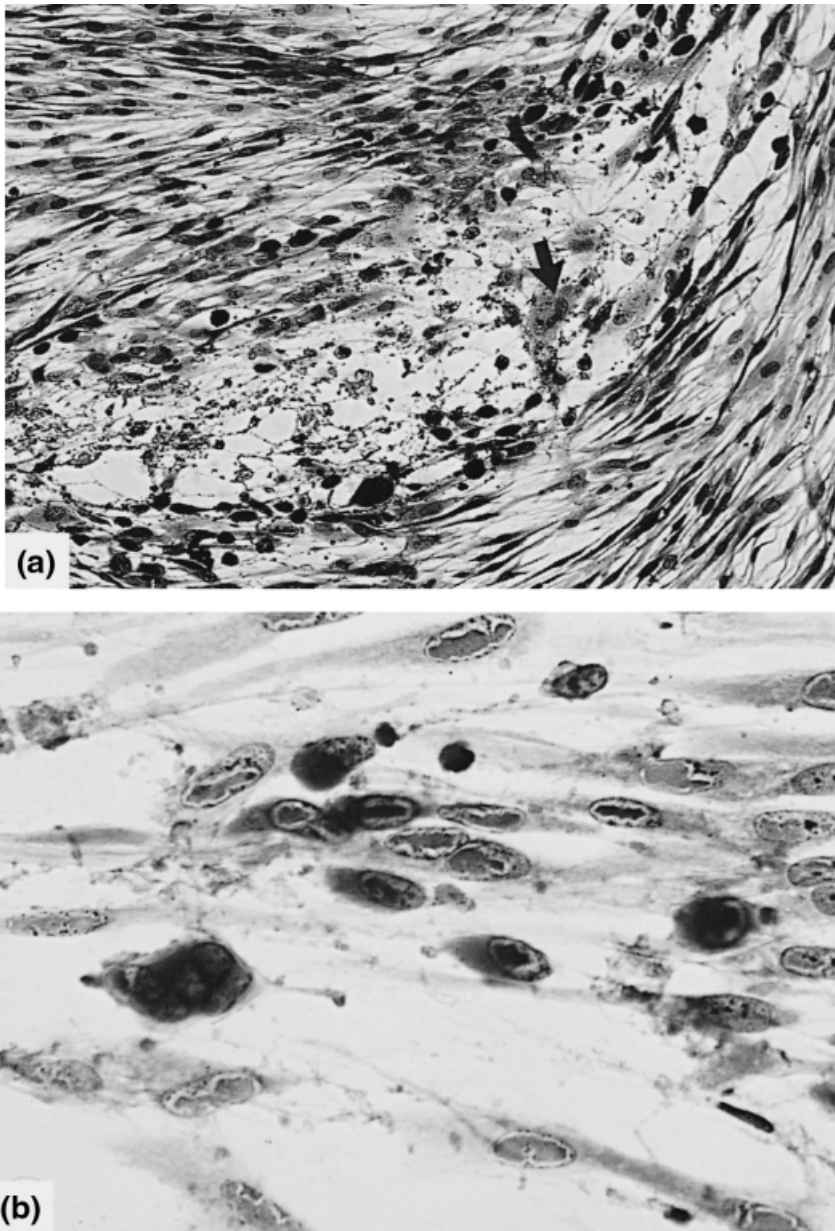

Figure 2B.4 (a) Stained VZV-infected human embryo lung fibroblasts. Note the rounded and multinucleated cells (arrow). (H&E) (b) High-power view with many affected cells showing typical intranuclear inclusions

ces have also been observed in the amino terminal region of ORF 10 (a tegument protein) which may be useful for identifying strains of Japanese origin, including the Oka vaccine strain. However, the biological significance of such minor antigenic differences is currently unknown.

Some serological cross-reaction with HSV does

occur, indicating that these two viruses share common antigens. It has not been shown conclusively on which of the viral proteins the responsible epitope (or epitopes) is situated. The gB glycoproteins of VZV and HSV have cross-reacting epitopes but it has been difficult to demonstrate any significant cross-reactivity with other proteins, in

spite of the sequence homologies between the two viruses. Thus, HSV and VZV cannot be regarded as closely related antigenically. The cross-reactivity manifests most prominently when an individual previously infected with one of the viruses becomes infected with the other virus. This would appear to be somewhat analogous with the theory of 'original antigenic sin' relating to influenza viruses. This postulated that when individuals become infected with a new influenza virus they not only develop antibodies to the new strain but also boost the levels of antibody to any different but antigenically related strains they have previously encountered. This theory cannot entirely explain the heterologous reactions between VZV and HSV since it is known that a small number of children, with no previous exposure to VZV but who are experiencing primary HSV infection, go on to develop low levels of antibody transiently which react with VZV. The converse has also occasionally been observed with patients experiencing primary VZV infection. It is not known whether this cross-reactivity extends to cellular immune responses or whether it confers any cross-protection between the two viruses.

It is also known that there is appreciable cross-reaction between VZV and simian viruses which cause varicella-like illnesses (see below). The level of cross-reactivity between these viruses is such that administration of live human varicella virus will prevent the development of clinical illness in animals subsequently infected with the simian virus.

Following infection with VZV, antibodies are produced to the various structural and non-structural proteins of VZV. Up to 30 protein bands can be detected with convalescent sera by radioimmunoprecipitation or immunoblotting. The predominant immunogenic components of the virus appear to be the glycoproteins, the major capsid protein and the assembly protein complex (Harper *et al.*, 1988). Both IgG and IgM antibodies react with these proteins (Figure 2B.5). Typically, sera from cases of zoster react more strongly and reveal a wider range of proteins compared to varicella. In addition, gE, gB and gH have been shown to be potential targets for the cell-mediated immune response against VZV. Firm data on other glycoproteins are still lacking in this area. Interestingly, the translational activator IE62 also appears to be a target for cellular responses (Arvin *et al.*, 1991), while the assembly proteinase/protein is a poor target.

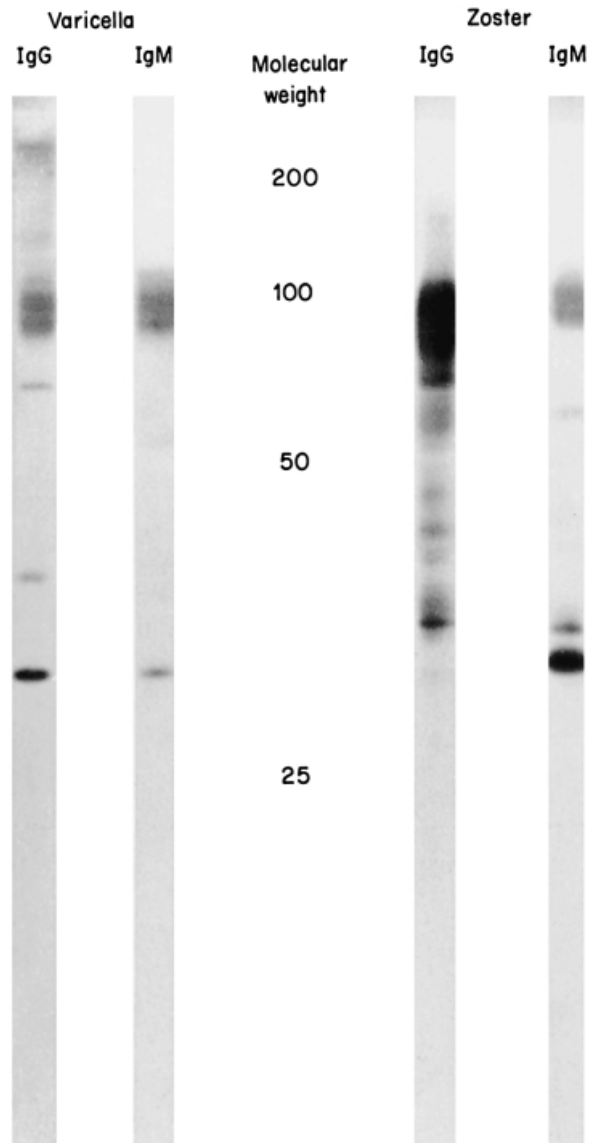

Figure 2B.5 Typical immunoblot patterns for IgG and IgM antibodies obtained with early convalescent sera from varicella and zoster cases. The viral proteins were separated on a 9% polyacrylamide gel, electroblotted on to nitrocellulose and reacted with the sera. IgG and IgM antibodies were detected with ^{125}I -labelled sheep antihuman IgG or IgM. The bands revealed by zoster sera are more numerous and more intense

Pathogenicity for Animals

Animals other than humans are reputed not to be susceptible to VZV but there are reports of successful infection of primates such as gorillas and chim-

panzees, and also marmosets. It has also been shown that guinea-pigs can be infected with virus which has been passaged in embryonic tissue obtained from these animals, leading to virus replication in the nasopharynx, viraemia and an immune response, but without a rash. Hairless guinea-pigs have been reported to develop a papular rash frequently after inoculation but this model remains challenging to use. Some progress has recently been made on studies of VZV latency (see below) using VZV-infected rats in which latent virus appears to behave in a fashion similar to that seen in human ganglia. However, no *in vivo* reactivation is observed in this model.

The lack of a good animal model of human VZV infections has hampered our understanding of the pathogenesis of these diseases. In passing it should be mentioned that outbreaks of varicella-like illness have been reported in several specimens of monkeys from primate centres throughout the world and viruses which are similar to VZV have been isolated from these monkeys. These viruses, which are immunologically indistinguishable from one another, are partially related to VZV, showing 70–75% DNA homology across the genome, and are currently being evaluated in an attempt to establish a useful model of VZV infection in humans. Studies of simian varicella virus continue to identify similarities to human VZV (Pumphrey and Gray, 1995) but the applicability of data obtained from such a model directly to humans is limited.

Pathogenesis

Our knowledge about the pathogenesis of VZV-induced diseases, particularly the primary infection, is still limited due to the difficulty in growing the virus and the lack of a suitable animal model.

Surprisingly little is known about the source and route of transmission of the virus. The skin lesions are certainly teeming with infectious virus, even at the maculopapular stage. Airborne transmission from skin lesions is therefore highly likely, especially since VZV DNA is readily detected by polymerase chain reaction (PCR) in the air surrounding patients with VZV infection. It is virtually impossible to isolate infectious virus at any stage from the upper respiratory tract of cases of varicella, although viral DNA may be detectable by PCR.

Nevertheless, it is widely believed that transmission occurs from this site, probably from symptomless oral lesions which are present before the skin eruption appears. Whatever the case, VZV undoubtedly is transmissible via an airborne route and does not require close personal contact. The clinical attack rate of varicella in outbreaks ranges typically from 80 to 90% of susceptible individuals, which compares well with other viruses transmitted via the respiratory route, e.g. 90% for measles.

The proposed model for the pathogenesis of varicella is shown in Figure 2B.6. It is presumed, as with the vast majority of human virus infections, that the respiratory tract is the portal of entry. Again it is presumed that after an initial phase of replication at the site of entry, the virus spreads to a distant site, the lymphoid system, where a second phase of replication takes place. What is certain is that after a period of about 14 days the virus arrives at its main target organ, the skin, and the final phase of replication occurs there. It is likely that the virus spreads to and replicates in many other organs of the body, particularly the lung. In most cases, the infection at these sites does not manifest clinically, presumably because little or no damage results from it. However, in those cases when extensive infection involves organs such as the lung or brain, serious disease can result.

There is considerable clinical evidence in support of this proposed model for the pathogenesis of varicella, and leucoviraemia has been demonstrated during the incubation period in healthy, as well as in immunocompromised, patients. For a full discussion of this subject see Grose (1987).

Histological examination of the skin lesions of both varicella and zoster shows focal degenerative changes in the epidermis. The affected cells are swollen and many of these contain well defined eosinophilic intranuclear inclusions. Multinucleated cells, also with intranuclear inclusions, are characteristically seen at the base of the lesion (Figure 2B.7). The histology of the skin lesions is thus essentially similar to the cytopathology seen in cell culture. The lesion extends and its centre fills at first with clear fluid, which then becomes cloudy due to the influx of inflammatory cells.

Termination of the infection at this site is indicated by the drying up of the pustules, which is followed by separation of the scabs and regeneration of the epithelium. Termination must be brought about by both the humoral and the cellular

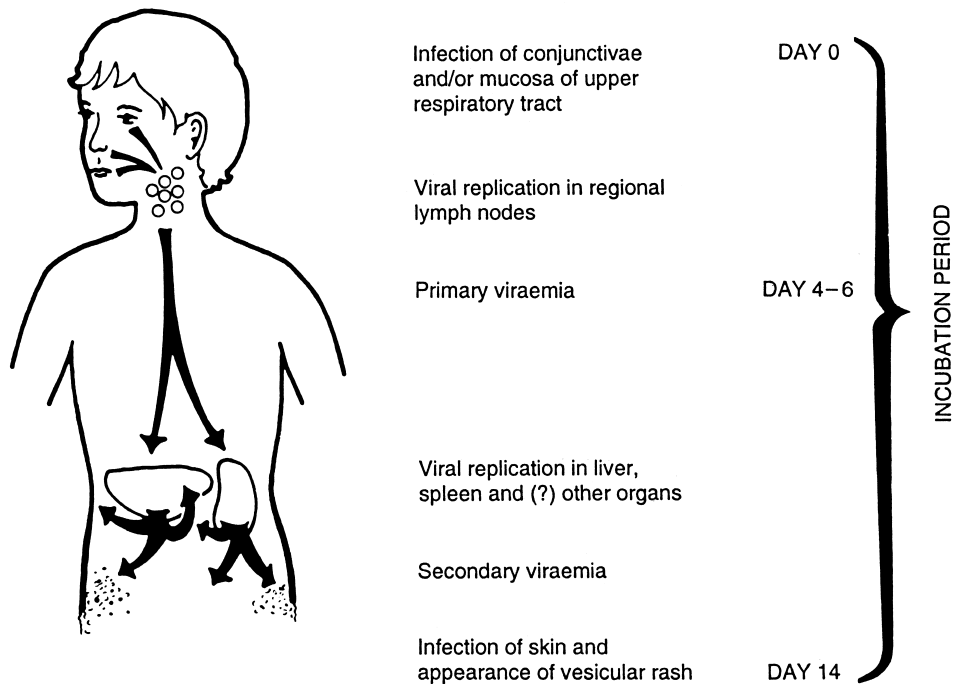

Figure 2B.6 Proposed model for the pathogenesis of varicella. (Reprinted by permission from C. Grose (1981) *Pediatrics*. **68**, 735-737; copyright 1981)

immune responses and it appears likely that the latter is the most important. The presence of large amounts of free and cell-associated virus in the lesion, as well as degenerating cells showing all the characteristic features of VZV infection, strongly suggests that the damage results from a lytic effect of the virus. The lesions in the immunocompromised are not modified in any way other than being more extensive and this makes it unlikely that immunopathology is playing an important part in their genesis.

Recovery from the primary infection results in lifelong immunity to exogenous infection, at least of the kind which manifests clinically. It is known, however, that this immunity is not complete, since it has been demonstrated that seropositive individuals who are in contact with varicella can occasionally show significant rises in the level of specific antibodies. Furthermore, viral DNA can be detected by PCR in nasopharyngeal secretions of immune individuals who are in close contact with chickenpox, suggesting that localized reinfections may occur. It is possible that such re-exposures to VZV throughout life help to maintain effective immunity to varicella, and maybe also zoster.

Latency

Following the primary infection, the virus remains latent in one or more posterior root ganglia. The trigeminal and thoracic ganglia are most frequently involved but ganglia at multiple sites may contain VZV DNA, including ganglia not directly connected with the skin (Furuta *et al.*, 1997). VZV can also infect T lymphocytes and this is likely to be the route of infection of at least some ganglia. In up to 20% of individuals a single recurrent infection occurs, usually after a period of several decades after the primary infection. The virus reactivates in the ganglion and then progresses peripherally down the sensory nerve to produce the typical skin lesions of herpes zoster which are restricted to the dermatome supplied by the nerve.

Less is known about VZV latency and reactivation than is known about the corresponding processes with HSV. During latency the viral DNA appears to exist in episomal form with fused genome termini. As discussed above, the TR_L/IR_L regions in VZV are shorter than in HSV. This is a significant finding since the genes for the HSV

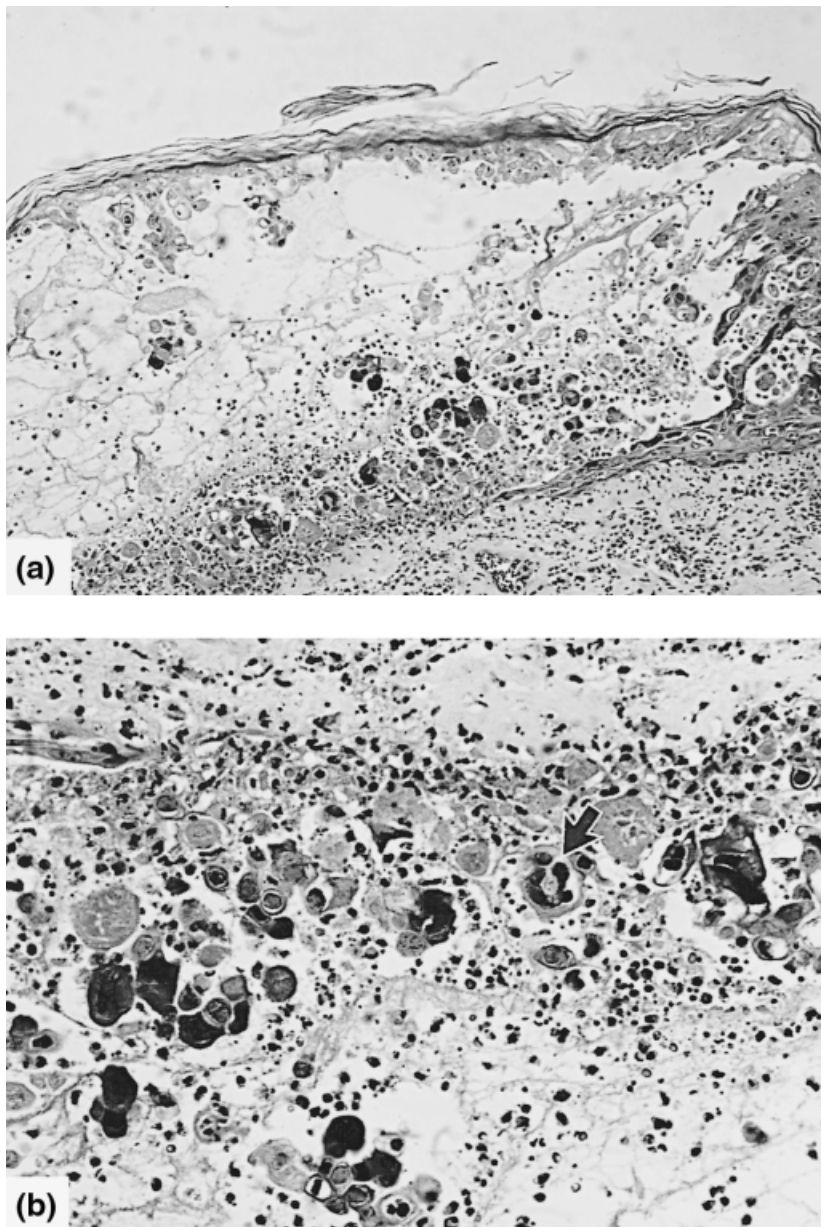

Figure 2B.7 VZV skin lesions. (a) Low-power view showing inflammatory exudate into the vesicle. (b) High-power view showing multinucleated cells (arrow). Many of the affected cells have typical intranuclear inclusions

latency-associated transcripts (LATs) and sequences required for neurovirulence are contained within these regions. The absence of LAT genes has initiated the search for alternative regulators in VZV. *In vitro* studies have shown that while the majority of the VZV genome is inactive during latency, at least two and possibly three discrete

regions of the genome are actively transcribed during latency. Transcripts appear to be produced from ORFs 21, 29, 62 and 63 and there is evidence that (unlike the situation with HSV) a protein—the ORF 63 product—is produced during latency (Mahalingam *et al.*, 1996).

Intense destructive inflammatory changes occur

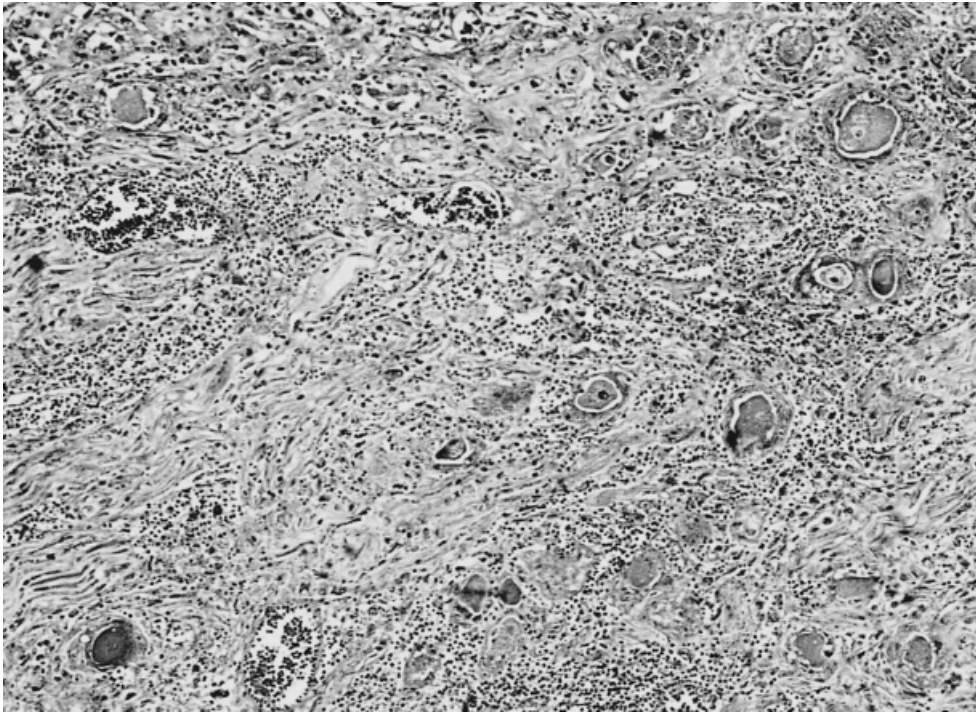

Figure 2B.8 Section of a posterior root ganglion obtained from a patient with herpes zoster. Note the intense inflammatory exudate and degenerate neurons. (H & E)

in the involved ganglion during reactivation (Figure 2B.8) and this may be reflected in the severe pain which frequently is experienced in association with zoster. It has been suggested from studies in the rat model that the site of latency is in satellite cells, rather than in neurons, and this would require a lytic cycle of infection initially to infect the sensory neurons during reactivation. This could explain the observed damage in the ganglia and the frequent prodromal pain experienced during zoster. However, more recent studies have shown that latent VZV is present in neurons (Kennedy *et al.*, 1998) and the reason for ganglionic damage remains unresolved. The failure of the host defence mechanisms to contain the virus in the ganglia after such prolonged periods of time is not understood. In immunocompetent individuals it is probably due to the decline of the effectiveness of previously acquired *cell-mediated* immunity to VZV with advancing years. Inadequacy of cell-mediated immunity is likely to be of critical importance since patients with Hodgkin's and similar diseases are more likely to experience zoster. These patients are also more likely to experience more than one attack

of the disease or they may develop the disseminated form of the disease. The term 'disseminated' implies that the virus spreads through viraemia from the affected dermatome to infect the skin or other organ at some distal site, producing lesions which are similar to those of varicella in their appearance and distribution. In recent years it has also been shown that the appearance of zoster correlates with increasing immunodeficiency in patients infected with human immunodeficiency virus (HIV), which primarily affects cellular immunity.

Most cases of zoster occur spontaneously but trauma and stress are well-known triggers of reactivation. It has been suggested that re-exposure to varicella may trigger zoster but this is based only on anecdotal reports.

EPIDEMIOLOGY

Cases of varicella are seen throughout the year but they occur more frequently in the winter and early spring months. The seasonal incidence of the dis-

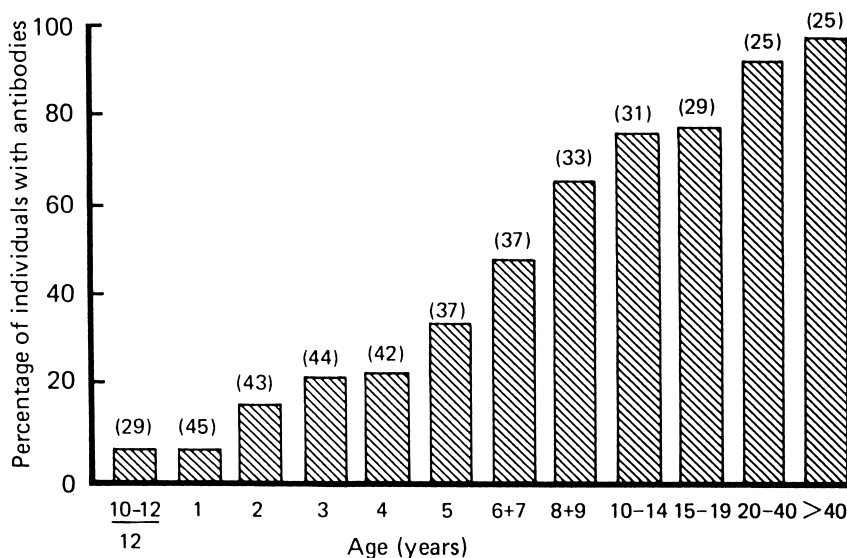

Figure 2B.9 Age prevalence of antibodies to VZV. The antibodies were detected by both RIA and indirect immunofluorescence procedures. The numbers of each age group tested are given at the ends of the columns. (These results were obtained in a collaborative study with Dr J. Cradock-Watson, Withington Hospital, Manchester)

ease is therefore roughly similar to that of other systemic diseases such as measles and rubella, and the respiratory viral infections, but quite unlike that of the enteroviruses. Because of the comparatively small variation in the seasonal incidence of varicella, it is preferable to regard it as a disease which shows variation in seasonal endemicity rather than an epidemic disease. Annual variation in incidence also occurs with higher than average incidence in 3–4 year cycles. Herpes zoster, in contrast, occurs sporadically and evenly throughout the year. Some of the cases of varicella which occur away from the peak periods are due to contacts with zoster.

Varicella is one of the most common communicable diseases worldwide and is predominantly a disease of childhood. However, different parts of the world can show significant variations in the age distribution of infection. In temperate areas it is one of the classic diseases of childhood, with the highest incidence occurring in the age group 4–10 years (Figure 2B.9). Infections before this age are relatively uncommon and include cases in the preschool years and also the rare congenital and neonatal infections, which will be discussed below. In general, varicella is highly communicable in temperate countries, with a reported attack rate of up to 96% in close contacts (i.e. household or play-friend), and therefore most people become infected before adult-

hood. Seroprevalence studies generally show that less than 10% of young adults are still susceptible to varicella (Figure 2B.9), although the rate of increase of seropositivity during preschool and school years may differ depending on local variations in exposure to the virus. Recent surveillance reports from the UK (Royal College of General Practitioners) and the USA indicate that the age-specific pattern of varicella may have changed in recent years. Firstly, there seems to be a trend towards higher incidence of varicella in preschool children, which may be related to an increased use of daycare and play-group facilities, leading to greater exposure at a younger age. Secondly, the incidence and overall proportion of cases in adults (aged over 15 years) appears to have increased during the past 20 years (Fairley and Miller, 1996). Before 1975, only 10% of reported cases of varicella in the UK were in adults, but this had risen to approximately 20% by 1989–1990. This is also reflected in increased consultations for varicella in general practices, increased hospitalization rates and more deaths among adults. It is now estimated that there are approximately 3000 hospital admissions for varicella per year in the UK, of which 40% are adults. There is evidence of a similar trend in the USA with a five-fold increase in hospital admission rates for varicella in adults in the past two decades (Choo *et al.*, 1995). The reasons for this shift in

incidence to older age groups are not known but smaller families, having the first child at an older age, and immigration of adults from countries with different varicella epidemiology (see below) may be contributing factors.

It is not known what role different environmental factors or different virus strains (see below) may play in determining the epidemiology of varicella but the patterns of infection and disease can be very different in tropical regions compared to those of temperate regions. In many tropical countries, varicella is predominantly a disease of adults, with a mean age of 20–25 years, or even as high as 38 years reported from St Lucia. Studies from the Indian subcontinent, South-East Asia and the Caribbean have shown that between 25 and 60% of adults over 15 years old are susceptible to varicella. Interestingly, there is also evidence of shifting epidemiology in these regions. Thus, the peak incidence of varicella in Singapore has shifted from 5–14-year-olds in 1982, to 15–24-year-olds in 1990 (Ooi *et al.*, 1992). It appears that very little transmission occurs amongst the young children in these areas, even though most of them live in crowded conditions and are in frequent contact with infected adults of their family. The reason for this is not understood but a number of theories have been put forward, including that it is due to competition with other viruses infecting the respiratory tract. Another possibility is that in these countries exposure in the early months of life is so common that infants experience asymptomatic infection due to the presence of maternally transferred antibodies. Latency perhaps does not always follow such infection and some individuals thus become susceptible later in life.

It is important in hospital practice in temperate climates to be aware of the fact that staff who were born in tropical countries are more likely to be susceptible to varicella.

Molecular Epidemiology

Using restriction fragment length polymorphisms (RFLPs) and PCR, strains of VZV in the USA have been shown to be related, and distinct from strains circulating in Japan (Takada *et al.*, 1995). Restriction analysis has also been used to prove that the virus causing chickenpox in an individual was the

same as that reactivating as zoster some years later and that Oka vaccine strain can be distinguished from wild-type viruses in the USA (Adams *et al.*, 1989). Most RFLPs are generated by variations in the numbers and sequence of repeats in the five (GC)-rich repeat regions, R1–R5, in the genome. RFLP differences between the Oka vaccine strain and wild type American strains have been described (Adams *et al.*, 1989), while PCR across a Bgl 1 restriction site in gene 54 and a Pst 1 site in gene 38 has simplified the identification of Oka which, unlike VZV in USA, is Pst 1 – Bgl 1 +. The Oka strain also differs from all UK strains tested but is genetically indistinguishable from about 3% of wild type Japanese strains. It is probable that, as with herpes simplex, geographical variations reflect selection by host factors. However, it is interesting to note that people from the Indian subcontinent, Singapore and Africa, despite their genetic differences, may carry similar strains of VZV (J. Breuer, unpublished data).

CLINICAL FEATURES

Varicella: The Primary Infection

The incubation period of varicella is approximately 2 weeks but a range of 7–23 days has been quoted. A shortened incubation period can be encountered, particularly in immunocompromised patients. A potential source of error in these estimates will be the infections that are acquired from asymptomatic cases.

The illness usually commences with the appearance of the rash but occasionally there are prodromal symptoms that resemble an influenza-like illness. These symptoms appear a few days before the rash and are seen more frequently in adults than in children.

The rash is characteristically centripetal in distribution and is seen mainly in areas that are not exposed to pressure, such as the flanks, between the shoulder blades and in the axillae. It is generally sparse in the antecubital and popliteal fossae and is rarely seen on the palms or the soles. This distribution is markedly different from the more centrifugal distribution of the smallpox rash, a distinction which used to be of considerable diagnostic importance. Other differentiating features were that the

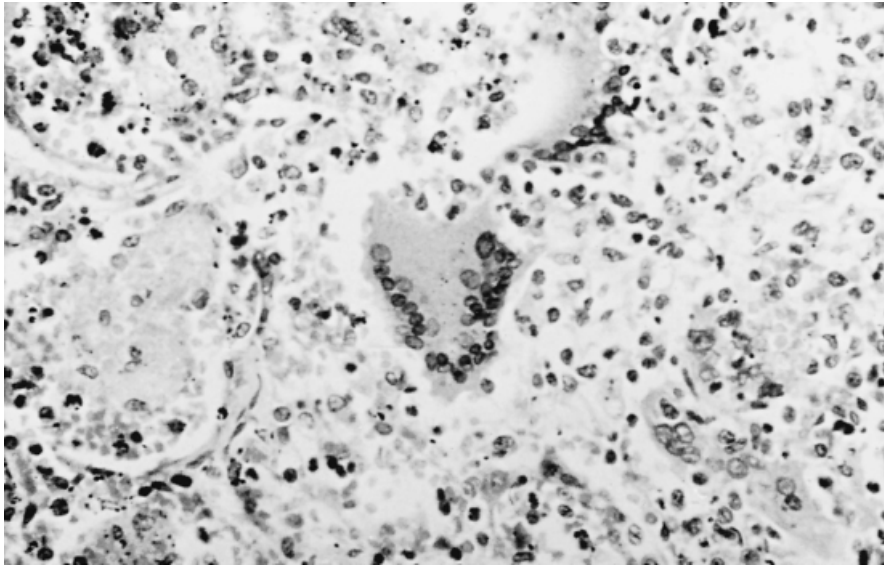

Figure 2B.10 Varicella pneumonia. Area of consolidated lung with typical multinucleated cells. (H & E)

lesions of smallpox are rounder and deeper than the more superficial and irregular shaped lesions of varicella.

The skin lesions progress fairly rapidly through the stages of macules and papules to vesicles which rapidly break down with crust formation. The vesicle with its surrounding area of erythema is the most characteristic feature of the rash. The lesions appear in a series of crops so that all stages in their genesis can be seen at any one time. This is very different from smallpox, where the lesions were always at the same stage. Patients with varicella are generally considered to be infectious from a couple of days before the rash until new vesicle formation has ceased and existing vesicles have crusted. This usually occurs 5–7 days after onset but may be longer in the immunocompromised. The crusts separate usually within 10 days, revealing healthy skin, but a minor degree of scarring is common. The general constitutional symptoms of the illness are typically mild, particularly in children.

Complications of varicella

Sepsis

Secondary bacterial infection is by far the most common complication of varicella, especially in children, and causes increased scarring of the skin.

Streptococci group A and staphylococci are most frequently involved and may be life threatening in the immunocompromised. Of those children requiring hospitalization for pneumonia associated with VZV, over 30% may have bacterial pathogens.

Viral Pneumonia

Symptomatic varicella pneumonia occurs in 1 per 200 000 cases of varicella in children, rising to 1 per 200 in immunocompetent adults, although radiological changes may be found in 10 times this number. In pregnant women the incidence of pneumonitis is increased to 9%, while 10% of smokers develop the disease. Those most at risk are the immunocompromised, including children with leukaemia, in whom up to 32% develop pneumonitis with a mortality of up to 25% (Feldman and Lott, 1987). Adults with malignant disease of the lymphoreticular system who have received organ transplants, and patients taking systemic steroids, are also at increased risk.

Pneumonia complicating varicella begins 1–3 (range 1–6) days after the onset of rash and the clinical features include dry cough, dyspnoea, tachypnoea with chest pain; haemoptysis and cyanosis occur less frequently. Over 90% of patients with chest symptoms will develop pneumonitis and all such patients should be admitted to hospital for antiviral therapy. Histological examination of an

area of lung affected by VZV shows alveoli filled with oedema fluid, a few foamy macrophages and other round cells. The absence of an extensive outpouring of polymorphonuclear leucocytes is a feature which distinguishes this disease from bacterial pneumonia. The presence of multinucleated giant cells with intranuclear inclusions (Figure 2B.10) is pathognomonic, although somewhat similar cells are seen in measles pneumonia. It is important to realize that these multinucleated cells are not always seen, but large swollen mononuclear cells, similar to cytomegalic cells, but without the dominant intranuclear inclusion, are always present. Clinical diagnosis is confirmed by chest X-ray changes and direct immunofluorescence of vesicle fluid and nasopharyngeal secretions using a fluorescein-conjugated monoclonal antibody or specific IgM antibodies in the serum.

The illness runs a fulminating course if not treated early with high dose intravenous acyclovir and is the single most common cause of varicella-associated death in the immunocompromised. Surviving patients may recover completely but others develop fibrosis of the lungs with permanent respiratory impairment.

Haemorrhagic Chickenpox

Haemorrhagic symptoms sometimes occur during the course of varicella and usually make their appearance on the second or third day of the rash. Haemorrhage typically occurs into the skin but epistaxis, melaena or haematuria may be additional presenting features. The haemorrhage may be so severe as to be life threatening. This complication is more commonly seen in immunocompromised patients, such as renal transplant recipients in whom a thrombocytopenia and/or consumptive coagulopathy may also develop. Other clinical features in these cases often include hepatitis and gastrointestinal bleeding or distention. Treatment is with high-dose intravenous antivirals (acyclovir or analogues) and intensive care. Intravenous immunoglobulin, although it has not formally been evaluated, is also commonly used. The addition of steroids is more controversial.

Encephalitis

Varicella meningoencephalitis necessitating admission to hospital, occurs in 3–4 cases per 100 000

children and more commonly in adults. Cerebral symptoms are more common in adults, while cerebellar ataxia occurs in children. In the majority of cases symptoms begin 4–8 days after onset of rash. Cerebrospinal fluid (CSF) examination may be normal or reveal a lymphocytosis, with a high cell count and protein level being more likely in encephalitis than in cerebellar disease. Typical cases of encephalitis presenting with headache and vomiting and proceeding to coma are rarely seen but carry a high mortality. By contrast, most patients with cerebellar disease recover fully, although it may take some months. Other neurological disorders including meningitis, transverse myelitis and Guillain–Barré syndrome have also been associated with the disease.

As with varicella pneumonia, central nervous system (CNS) involvement occurs much more frequently in immunocompromised patients and is another important factor contributing to the increased mortality of the disease in these patients.

Other Unusual Manifestations and Complications of Varicella

As mentioned under Pathogenesis above, VZV infection may involve virtually any organ of the body but, apart from the skin and occasionally the lung and brain, it is unusual for infection at other sites to manifest clinically. Nevertheless, myocarditis, arthritis, hepatitis and both renal and ureteric damage associated with varicella have been reported.

Reye's syndrome is a serious and frequently fatal form of encephalopathy which is secondary to liver damage occurring in children with varicella or influenza and is associated with ingestion of aspirin. The incidence of this has fallen with strictures on the use of salicylates in children.

Varicella in Pregnancy

From Figure 2B.9 it can be seen that approximately 10% of women of childbearing age are still susceptible to varicella but this figure may be as high as 20% in communities with a high proportion of immigrants from India and Africa. The incidence of varicella in adults aged 15–44 years has been estimated at 3 cases per 1000, which would result in about 2000 cases per year in pregnant women in

Table 2B.3 Clinical features of the congenital varicella syndrome

Scarring of the skin
Hypoplasia of the limbs, muscular atrophy, rudimentary digits
Cortical atrophy, psychomotor retardation
Choreoretinitis, cataracts

England and Wales. In areas with immigrant populations from India and Africa, the incidence may be twice as high. Varicella in pregnancy can present two quite distinct problems, depending on whether the infection is contracted in the early or in the very late stages of the pregnancy. For a review of varicella in pregnancy, see Hanshaw *et al.* (1985).

Varicella in the Early Stages of Pregnancy

Congenital varicella syndrome occurs in fewer than 1% of fetuses where maternal infection occurs before 13 weeks of gestation, but this rises to 2% if maternal infection occurs between weeks 13 and 20 (Enders *et al.*, 1994; Pastusak *et al.*, 1994). The main features of this syndrome are shown in Table 2B.3. Certain defects, such as those involving the brain and eye, are similar to those seen in congenital infections caused by rubella virus and CMV but other features are quite different. Scarring of the skin, which can be extensive, is a unique feature of the varicella syndrome and indicates that VZV is dermatotropic even *in utero*. Other unique features are the hypoplasia of limbs and rudimentary or even missing digits, indicating that VZV intrauterine infection has a marked propensity for the musculoskeletal system. Gastrointestinal abnormalities are also described. The pathogenesis of the unique lesions of the congenital varicella syndrome is not fully understood but it is possible that they result from fetal zoster following the initial VZV infection. The very short latency period is explained by poorly developed cell-mediated immunity in the fetus.

All of the reported cases in the literature were seriously affected and less than half of them survived beyond 20 months. In addition, a few cases have been reported in the literature of babies born with severe disseminated varicella acquired as late as the 25th week of gestation. Exposure to maternal varicella *in utero*, although only rarely resulting in fetal damage, may result in shingles in infancy or early childhood.

Varicella in the Late Stages of Pregnancy

In common with other viruses (e.g. poliovirus), varicella is known to cross the placenta in the late stages of pregnancy, causing congenital infection of the fetus, and infection acquired in this way can result in the child developing varicella. Varicella occurring within 10 days of delivery is evidence of intrauterine infection. The risk of a child acquiring varicella in this way is dependent on the rapidity with which the mother develops and transfers humoral immunity across the placenta and also the time interval between the date of onset of the rash in the mother and the date of delivery. This period is important because it affects the management of these cases. From numerous clinical observations it has now become consistently apparent that if the onset of the rash in the mother occurred 7 days or more before delivery, sufficient immunity will have been transferred so that even if infection has occurred *in utero* it will subsequently be mild or even inapparent. In contrast, if the onset of the mother's rash is 6 days or less before delivery, the child will be exposed to infection without the protection of maternally transferred antibody. Young children infected in this way may experience severe fatal disseminated forms of the disease. Case-fatality rates of approximately 30% have been reported for untreated neonatal varicella. Also at risk of severe infection are babies born to seronegative mothers who contract varicella in the neonatal period, as no passive immunity will have been transferred from the mother. The administration of varicella zoster immune globulin (VZIG) to attenuate infection (see below) is therefore recommended for all children in contact with varicella within the first 28 days of birth where the mother is seronegative. Infected children born to seropositive mothers are usually protected, although it is worth noting that this protection is not complete, since cases of mild varicella have been reported in babies born to seropositive mothers. The protective efficacy of the maternal antibodies is maximal during the first 2 months of life. Children born before 32 weeks gestation may not have acquired maternal immunity even if the mother has antibodies to VZV. In such cases, and indeed in all cases where a prematurely born infant is exposed to varicella while in hospital, it is advisable to test the infant for varicella antibody and administer prophylactic VZIG if it is absent.

As mentioned above, the pathogenesis of

varicella is not fully understood. The behaviour of VZV in pregnancy does, however, shed some light on this. First, the fact that intrauterine infection occurs at all provides further evidence that primary infection must have a viraemic phase. Of greater significance is the observation that serious congenital varicella will occur only if the onset of the maternal rash is within 7 days of delivery. This clearly indicates that humoral immunity can affect the course of infection.

Herpes Zoster: The Recurrent Infection

This is the recurrent form of VZV which typically affects a single dermatome of the skin. The average annual incidence is 0.2% and it can occur at any age, although the vast majority of individuals experiencing this disease are more than 50 years old. Shingles is rare in children except among those exposed *in utero*.

The disease is a result of the virus reactivating in a single sensory ganglion and then proceeding peripherally down the associated sensory nerve to infect the skin supplied by that nerve. The siting of the skin lesion is therefore dependent on the involved ganglion. The ophthalmic branch of the trigeminal nerve as well as the lower cervical (in children especially), thoracic and lumbar (T5–L2) posterior root ganglia are those that are most frequently involved. The eruption is usually preceded by paraesthesia and, perhaps, burning or shooting pains in the involved segment and the skin may be exquisitely tender to the touch (hyperaesthesia). This is followed by the familiar unilateral ‘strap’ of vesicles on the trunk. This can be accompanied by muscle weakness in the affected or adjoining limb. The density of the vesicles is very variable, being often sparse in children but densely packed in adults. Definitive involvement of the eye in ophthalmic shingles is signalled by vesicles appearing at the tip of the nose which is supplied by the nasopharyngeal branch of the nerve, Hutchinsons’s sign. Where the sacral ganglia may be involved, the skin lesions may be associated with retention of urine or symptoms suggestive of urinary tract infection and, sometimes, frank haemorrhagic cystitis. Facial palsy associated with vesicles in the external auditory meatus is known as the Ramsay Hunt syndrome and is thought to be a form of zoster involving the geniculate ganglion of the seventh nerve. It is often accompanied by hearing loss and vertigo. The

pathology of this form of zoster is, however, disputed and it is preferable to refer to this disease as aural zoster rather than by its eponymous title or even ‘geniculate herpes’. VZV reactivation has also been implicated as a cause of facial Bell’s-type palsy without vesicles or other symptoms but this association is difficult to prove. It is rare, other than in immunocompromised patients, that more than one dermatome is involved. A forme fruste of herpes zoster (zoster sine herpete) in which dermatomal pain is present without lesions, has been shown to be associated with high IgG antibody titres to VZV and in some cases VZV DNA is detectable by PCR in circulating lymphocytes (Gilden *et al.*, 1994).

As with primary VZV infection, herpes zoster is a far greater problem in immunocompromised patients. In these individuals it frequently occurs earlier in life and second attacks, which are virtually unknown in the immunocompetent, are sometimes seen. Moreover, the disease process is frequently prolonged in immunocompromised patients and they are most likely to experience the disseminated form of zoster. If any patient with zoster is examined carefully it is not uncommon to find isolated vesicles in areas of the skin far away from the main lesion. This means that a minor degree of dissemination must occur quite frequently. In one study, asymptomatic VZV viraemia was detected in 19% of bone marrow transplant recipients, using PCR (Wilson *et al.*, 1992). In the immunocompromised patient, however, extensive dissemination of the virus can occur so that the appearance is identical to varicella but with the addition of the zoster lesion. Such patients are frequently extremely ill, often with visceral involvement, but with antiviral therapy there is rarely a fatal outcome.

Herpes zoster, unlike varicella, does not usually present a problem during pregnancy. The disease is typically mild in pregnant women and transmission to the fetus is not described. Herpes zoster near term is not associated with serious neonatal infection, presumably because of the protection afforded by maternal antibodies.

Complications of Herpes Zoster

Infection

As with varicella, secondary bacterial infection of the skin can occur and occasionally can lead to

impetigo or cellulitis, but with appropriate anti-biotic therapy this is rarely a serious problem.

Neuralgia

Pain lasting more than 4 weeks after the onset of the rash has been termed postherpetic neuralgia. Since the pain is usually a continuum of the pain occurring during the acute phase, a more modern terminology is zoster associated pain (ZAP). Prolonged ZAP is the most common complication of zoster, occurring in 15% of cases overall and up to 40% of those aged 60 years and over. Nearly all patients experience severe acute pain at the site of the lesion, although the severity and duration increase with age. The pain may be present before the onset of the rash but, in just over 85% per cent of cases, it remits within 2–3 weeks. It may consist of a constant pain, an intermittent stabbing pain or paraesthesia. In some patients severe disabling chronic pain occurs. The cause of the pain is not clear but is associated with ganglionic destruction and scarring with perturbation of type C nociceptor function (Rowbotham and Fields, 1996). Symptoms may be precipitated by temperature change and are often worse at night. Age and, when that is controlled for, severity of pain at the onset of zoster are the factors which most strongly predict severe ZAP. Treatment with antiviral drugs will reduce the incidence, duration and severity of ZAP if started within 72 hours of the onset of rash, especially in those over 55 years. Recent studies also suggest that the level of active drug, both peak values and total dose (area under the curve) are inversely correlated with severity and duration of ZAP (Beutner *et al.*, 1995). Postherpetic neuralgia is rarely seen in children.

Encephalitis and Myelitis

Should a patient with zoster lapse into a coma then encephalitis should be suspected. Typically the rash involves the cranial or upper cervical nerves. It is, fortunately, very rare and little is known about its pathogenesis.

A number of clinical observations have strongly suggested that motor as well as sensory neurons may be involved in cases of herpes zoster. Ptosis associated with ophthalmic zoster and paralysis of the intrinsic muscles of the hand associated with skin lesions of the deltoid region are examples of this. The phenomenon is thought to be due to cen-

tripetal spread of the virus from a ganglion into the central nervous system and thence into a motor neuron. It is possible that facial palsy with aural herpes referred to above may be mediated in this way rather than through involvement of the geniculate ganglion. Most of the motor neuropathies are fortunately transient and serious sequelae are rarely seen. Guillain–Barré syndrome and transverse myelitis with ascending paralysis have been reported in small numbers of cases and appear to be more common in HIV positive patients. A rare but serious complication, particularly associated with ophthalmic zoster, is contralateral hemiparesis. This is caused by a granulomatous inflammatory process in the brain with infarction of the cerebral arteries.

Ocular

The presentation of ophthalmic zoster is complex because of the many structures of the eye and its surrounds which can be involved, such as the eyelid, conjunctiva, sclera, cornea and iris. Consequently the risk of complications is high even in immunocompetent individuals. The risk of complications is particularly high if the nasociliary branch of the fifth cranial nerve is involved. Iritis and keratitis are the most common complications. Blindness following ophthalmic zoster is, however, rare.

Varicella Retinitis

Acute retinal necrosis due to reactivation of VZV has been described, and is characterized by focal, well-demarcated necrotizing retinitis occurring predominantly unilaterally. Treatment with intravenous acyclovir produces improvement within 48–72 hours and prevents the development of ragged retinal holes and retinal detachment. A similar picture can be produced by HSV, usually in association with encephalitis. The clinical complexities of ophthalmic zoster have been reviewed by Marsh (1976) and Culbertson *et al.* (1996).

In patients with the acquired immunodeficiency syndrome (AIDS), rapidly progressive herpetic retinal necrosis due to VZV infection has been recognized. First described as progressive outer retinal necrosis (PORN), the condition is characterized by outer retinal opacification, absence of inflammatory changes in the eye bilaterality and multifocality. The signs are rapidly progressive and are distinct from the retinal infiltration and haemorrhages seen

in CMV retinitis. Untreated, PORN quickly progresses to bilateral total blindness. VZV is the most common cause of this condition and is diagnosed by PCR of fluid from the anterior chamber. Treatment with intravenous acyclovir or ganciclovir may halt the progression of the lesions but will not usually affect the loss of visual acuity. Foscarnet has also been used both alone and in combination with a nucleoside analogue, most commonly ganciclovir. Both foscarnet and ganciclovir have been given as intravitreal injections.

Zoster and HIV

Zoster occurs in up to 20% of patients with HIV infection, and in parts of Africa 85% of patients with zoster aged less than 45 years are HIV-1 positive. Most episodes of zoster occur early in the HIV disease process, before the CD4 cell count has fallen, and tend to be unidermatomal. Zoster occurring after onset of AIDS is associated with disseminated and multidermatomal zoster. Recurrent zoster is also more common as the CD4 cell count falls and some patients may develop a chronic form of zoster with atypical verrucous-like skin lesions, which have been associated with decreased expression of VZV gE and gB (Nikkels *et al.*, 1997).

DIAGNOSIS OF VZV INFECTION

The clinical presentations of both varicella and herpes zoster are usually so typical that laboratory confirmation is rarely required. Notwithstanding, in one series of shingles diagnosed clinically in the community, 15% turned out to be due to HSV infection or non-herpetic (J.Breuer, unpublished data). Where the distinction between HSV infection and herpes zoster is difficult, such as in a generalized rash occurring in an immunocompromised patient or where atypical lesions occur, laboratory confirmation should be sought. Similarly, laboratory diagnosis may also be useful for some of the rarer CNS and ocular complications affecting immunocompromised patients. The VZV antibody status of an individual is also commonly required now that treatment and prophylactic measures are readily available, and also because of the increasing problem of nosocomial varicella outbreaks which require prompt intervention.

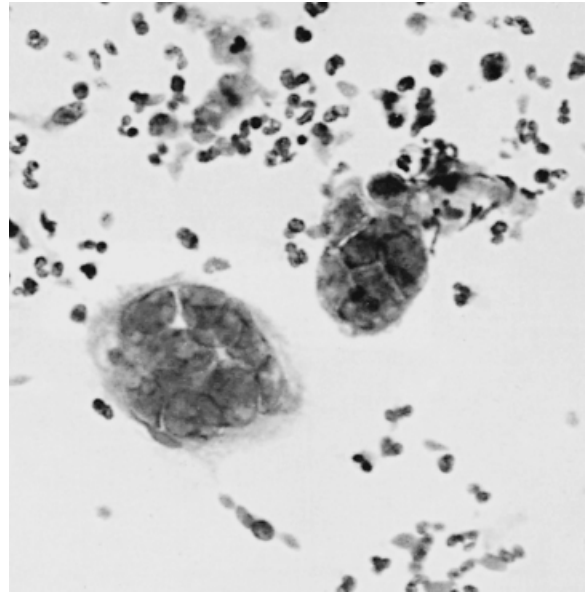

Figure 2B.11 Scraping of the base of a lesion of herpes zoster. Note the typical multinucleated cells. (Papanicolaou)

Direct Demonstration Techniques

The main advantage of these techniques is that they are rapid, usually giving results on the same day that the specimen is received.

Electron Microscopy (EM)

Typical herpesvirus particles can be seen in profusion in fluid taken from early vesicles of either varicella or zoster. The particles can also be seen in emulsions of material scraped from the base of lesions. The particles are more difficult to see when the specimens are taken late in the disease. EM will not distinguish between VZV and HSV infection unless combined with immunological techniques.

Cytology

Smears of scrapings of the base of the lesions, stained by Papanicolaou's method or, for quickness, methylene blue, will reveal characteristic multinucleated giant cells (Figure 2B.11), also known as Tzanck cells. Although not a routine procedure, microscopic examination of biopsies of the lesion will also reveal these giant cells as well as the other characteristics of the histology which have

been described above. Again, it is unfortunate that neither cytology or histology will distinguish between HSV- and VZV-induced lesions.

Immunofluorescence Cytology

A more specific diagnosis can be made if immunofluorescence or immunoperoxidase examination of the smears is carried out. Even cells from crusted lesions contain viral antigen in abundance, allowing easy detection. This method is therefore particularly useful at a time when EM or virus isolation (see below) may not be reliable. Direct detection of VZV in cells scraped from the base of a vesicle is now easily achieved using a fluorescein isothiocyanate conjugated monoclonal antibody. This simple method has replaced indirect immunofluorescence.

Detection of Viral DNA

Both dot-blot and *in situ* hybridization have been used for diagnosing VZV infections. While they may be useful for specific investigations, they are too cumbersome and insensitive to be used as routine diagnostic tests. However, the PCR has proven to be a valuable tool for the diagnosis of VZV CNS and ocular disease. It may not be as reliable as PCR for the diagnosis of HSV encephalitis, which reflects the difference in pathogenesis between the two diseases, but it offers better prospects than the alternatives which are brain biopsy or serology. It is not known at present how frequently VZV DNA can be detected in CSF by PCR in uncomplicated cases of varicella and zoster. PCR has also proved useful for detection of VZV in vesicle fluid and even crusts. PCR of vitreous fluid is also used to confirm the diagnosis of acute retinal necrosis and PORN.

Virus Isolation

This remains the most definitive method for diagnosing VZV infections. It is important that the cell culture used can easily be maintained for up to 21 days because this may be required for some isolations. It is for this reason that human fibroblast cultures are used in most laboratories.

Vesicle fluid or material swabbed from the base of fresh lesions are the specimens which are most suit-

able for isolation attempts. Supernatants from emulsion of affected organs such as the lung, obtained at postmortem examination or by biopsy, can also be used. Virus can rarely, if ever, be recovered from crusted lesions, the upper respiratory tract or blood.

With virus-containing specimens, the characteristic cytopathic effect of VZV will ultimately be produced (Figure 2B.3). Occasionally, clinical isolates only show a restricted cytopathic effect on primary isolation and require 'blind passage' on to fresh fibroblast cultures before the classical cytopathic effect develops.

It is possible to increase the speed of isolation by centrifugation-enhanced infection ('shell-vial' culture). In addition, immunological staining techniques utilizing monoclonal antibodies can be used to detect viral antigens in cell cultures within 24–48 hours of inoculation, before cytopathic effect becomes apparent. (Figure 2B.12).

Identification of Isolates

Many laboratories do not undertake further identification of isolates because the cytopathic effect of VZV is so characteristic. This is not unreasonable provided that there is awareness that the early changes in the culture may not be too dissimilar from the early cytopathic effect of both HSV and CMV.

The definitive identification of an isolate has traditionally involved tedious methods where a crude antigen preparation is prepared from the affected cell sheet and reacted with a standard VZV antiserum in serological tests such as the complement fixation test. However, staining with VZV monoclonal antibodies (Figure 2B.12) or detection of viral DNA by, for example, PCR now provide simple and rapid means of identification.

Serological Diagnosis

A number of different methods are currently available for the serological diagnosis of VZV infection, but perhaps the most important use of this technology is the determination of immune status of patients prior to the administration of prophylactics.

The serological diagnosis of varicella using acute and convalescent sera is easily accomplished but is

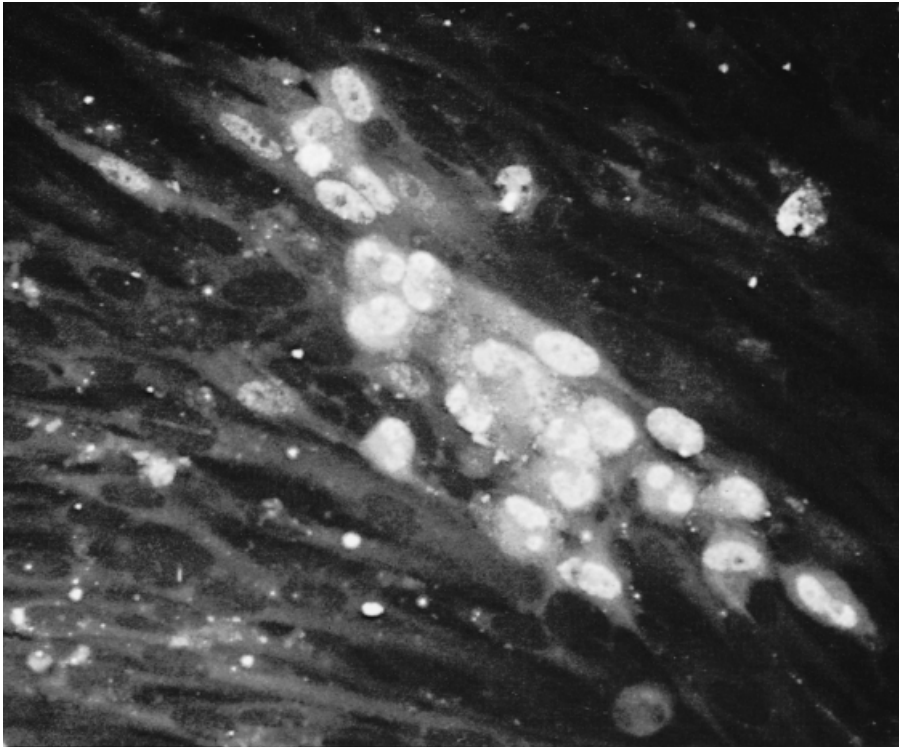

Figure 2B.12 Immunofluorescence staining of a cell sheet of human embryo lung fibroblast cells infected with VZV. An indirect method with monoclonal antibody was used

less reliable for herpes zoster. Sera obtained in the early stages of varicella are either devoid of or contain only low levels of specific antibody, whereas these antibodies are present in high titre in sera taken in the convalescent period. While significant rises in antibody titre in paired sera can be demonstrated in cases of zoster, this is in general only possible if the first serum is taken soon after the onset of the rash, for the reason that pre-eruption sera will always contain some specific antibodies and the titres rise very rapidly after onset. In cases of zoster it is not uncommon to see a drop in the pre-eruption antibody level around the time of onset so that the antibodies may barely be detectable in sera taken within the first 2 days after appearance of the rash. Testing for avidity of IgG antibodies provides a means of distinguishing between primary and anamnestic antibody responses.

The sharing of antigens between VZV and HSV (discussed above) sometimes makes the interpretation of serological results difficult. It is quite frequently found that levels of antibodies to both VZV

and HSV will have shown significant rises in association with a particular illness; however, without additional information, such as virus isolation data, it may be impossible to determine which of these viruses was responsible for the infection.

Complement Fixation (CF)

This test is now all but obsolete for the diagnosis of VZV as it is too slow, not sensitive enough for the determination of immune status and more susceptible to cross-reaction between VZV and HSV than other tests.

Immunofluorescence (IF)

This method provides a sensitive determination of serological status to VZV but has now been superseded by enzyme immunoassays in most diagnostic laboratories. In IF tests, serial dilutions of sera are reacted with VZV-infected culture cells, and any specific antibodies attaching to these cells are detected.

ted with a fluorescein-conjugated antihuman IgG serum. There are two variants of this basic test. One is the standard IF procedure in which sera react with acetone-treated culture cells and is therefore capable, at least theoretically, of detecting antibodies to all virus-induced proteins. The fluorescent antibody to membrane antigen (FAMA) technique uses glutaraldehyde-fixed cells and is designed to detect only antibodies to viral antigens that appear on the surface of infected cells. Consequently FAMA should, in theory, specifically detect those antibodies which are concerned with protection.

Enzyme Immunoassays (EIAs)

These are generally regarded as being the most sensitive methods for detecting specific antiviral antibodies, and are therefore the preferred method for determining immune status, but they have no advantage over CF for routine diagnostic purposes. Assays of the indirect solid phase kind are used most frequently but a competitive type assay has also been described which should, theoretically, not be affected by cross-reacting antibodies to HSV.

Several EIAs are now commercially available and are for practical reasons the most commonly used method for determining immune status.

Neutralization

Theoretically this should be the method of choice for determining VZV immune status, since it measures antibodies concerned with protection. However, current procedures are technically very difficult to carry out, due mainly to the difficulty of obtaining a consistent supply of challenge virus, since virus infectivity is so highly cell associated. It is also an insensitive test. For these reasons, it has no role in routine diagnosis.

Detection of VZV-Specific IgM Class Antibodies

This class of antibody can be detected using the indirect IF or immunoassay procedures in which the labelled antibody used in the system is directed against human IgM class antibodies. Procedures in which the IgM antibodies are captured on to the solid phase (MACRIA or MACEIA) can also be used. VZV IgM may not initially be detectable in sera from patients with varicella but is present in

100% of convalescent sera, and it can be detected for about 3 months from the onset of the illness. Tests for specific VZV IgM are therefore useful for diagnosing recent infection when the only sera available are those taken late or after the termination of the illness.

It is, unfortunately, not possible to use these tests to distinguish reliably between primary and recurrent VZV infection, since specific IgM antibodies are also induced in most cases of herpes zoster. In these patients, however, the amount of IgM antibody is generally lower than that found in varicella cases and is also of shorter duration (Figure 2B.13).

The VZV IgM tests are likely to prove valuable for determining the nature of congenital varicella infections.

MANAGEMENT

Varicella

Varicella in healthy individuals is generally mild and complications are rare. Where treatment is indicated, the drug of choice is acyclovir, a nucleoside analogue which blocks viral replication. VZV is less susceptible to acyclovir than is HSV and requires approximately a tenfold higher concentration of the drug for effective inhibition. The inhibitory concentration (ID₅₀) of acyclovir for VZV in cell culture is usually in the range 2–20 $\mu\text{mol L}^{-1}$ depending on the cell type and virus strain used. It is possible to obtain adequate inhibitory concentrations in the blood if a dose of 10 mg kg^{-1} (or 500 mg m^{-2} for children < 12 years old) is given intravenously over a 1 hour period every 8 hours. This dosage maintains plasma levels in the range 10–90 mol l^{-1} . Duration of treatment is normally 5–10 days, depending on the severity and progression of the disease, but a minimum of 7 days is recommended for immunocompromised patients and adults with visceral complications. Oral acyclovir is poorly absorbed and the recommended dose of 800 mg 5 times a day, will give blood levels of 4–8 $\mu\text{mol l}^{-1}$, which are only just at the ID₅₀ concentration for VZV. Studies in children (Dunkle *et al.*, 1991) and adults (Wallace *et al.*, 1992) have shown that antiviral treatment must be started within 24 hours of the onset of rash to be effective. In immunocompetent patients, the duration of rash and fever are

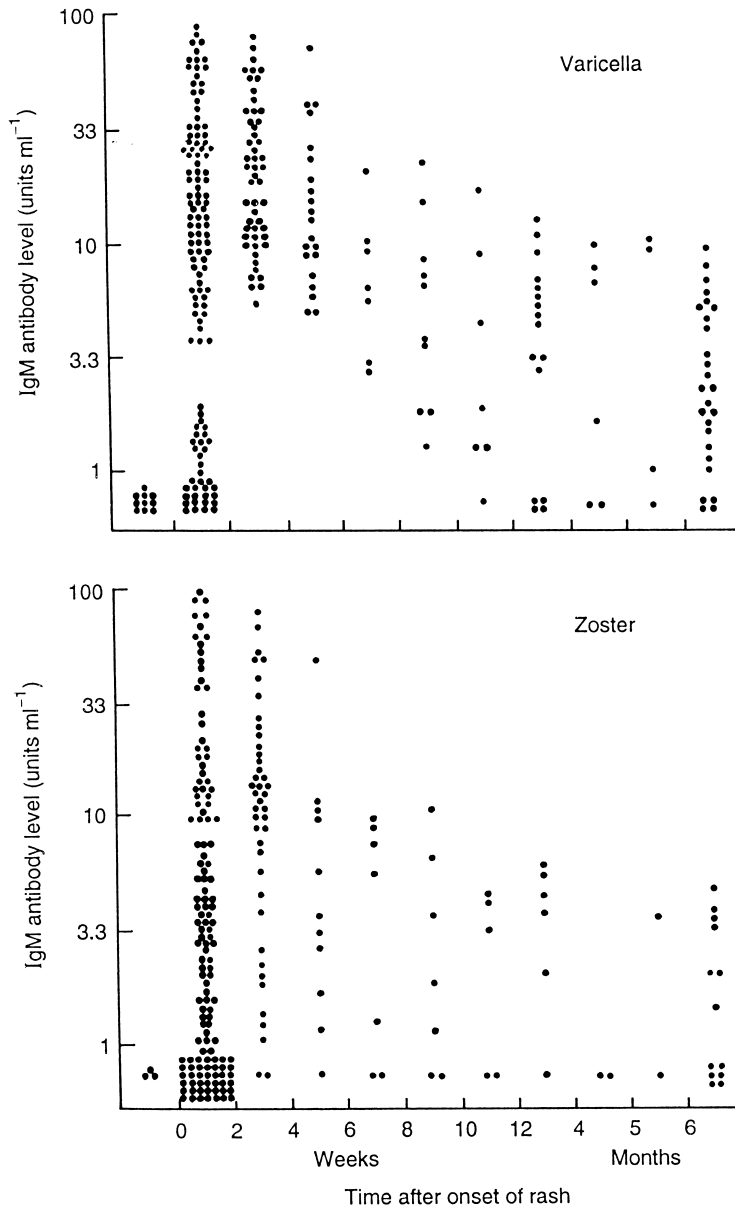

Figure 2B.13 Detection and duration of the specific IgM response in patients with varicella and herpes zoster. MACRIA was used for the antibody determinations

reduced by treatment with acyclovir but none of the studies has had the power to show whether treatment reduces the risk of complications.

The nucleoside analogues famciclovir (*Famvir*TM) and valaciclovir (*Valtrex*TM), both of which are better absorbed orally (50–70%) than acyclovir (20%), metabolize to produce blood levels of active drug equivalent to intravenous acyclovir. However, these

have not yet been licensed for the treatment of varicella.

A detailed review and recommendations for the management of varicella in different patient groups have recently been prepared by the UK Advisory Group on Chickenpox for the British Society for the Study of Infection (Carrington and McKendrick, 1998).

Varicella in Children

For the typical childhood case, no treatment is required, apart, perhaps, for soothing lotions for itching and antibiotics if there is any question of secondary infection. There is some evidence that secondary cases of varicella acquired within a family are more severe and treatment of such cases, particularly adolescents, is advocated by some, although current UK consensus is not to use oral acyclovir routinely in healthy children. Children on inhaled or intranasal steroids are not considered to be at special risk but such cases should be considered individually. No great pressure is usually exerted on parents even to quarantine affected children and, indeed, there are some who advocate that it is preferable for children to contract the disease to ensure that immunity is acquired at an early age.

Varicella in Adults

One in 200 adults will develop clinical pneumonitis and approximately 1 in 2000 will require intensive care. Those most at risk include smokers and patients with severe chronic lung conditions. Acyclovir commenced within 24 hours of the onset of symptoms does reduce viral shedding and new lesion formation by 0.5 days, and accelerates rash healing by 1–2 days (Wallace *et al.*, 1992). Pregnant women are also at increased risk of pneumonitis but acyclovir is currently not licensed for use in pregnancy. However, it has been used successfully in numerous pregnant women to treat serious VZV disease without ill-effect and there is no evidence to date that it is teratogenic, although it is known to cross the placenta and can be detected in urine from infants of mothers who have been treated. It is not known at present whether treatment with acyclovir has any beneficial effect on fetal varicella syndrome. Current UK recommendations are therefore to treat varicella presenting within 24 hours in otherwise healthy adult smokers, patients with chronic lung conditions (including adults on inhaled steroids) and pregnant women in the second half of pregnancy (Carrington and McKendrick, 1998). Adults presenting more than 24 hours after the onset of the rash should have their clinical progress assessed. Those who appear to be deteriorating, for example with recurrent fever or progressive rash or who develop chest symptoms or signs, should be admitted for chest X-ray, gases and assessment as to

whether they need intravenous acyclovir and antibiotics. For detailed algorithms for the management of varicella in adults see Wilkins *et al.* (1998).

Varicella in the Immunocompromised Patient

Varicella in the immunocompromised can be a serious, even fatal, illness and consequently its management in these patients is different from that in a previously healthy individual. Immunocompromised patients, including those on systemic steroids (including for up to 3 months previously), should be aware of their immune status and, where possible, i.e. in all except those with lymphoreticular malignancies, be immunized with live attenuated Oka vaccine. Where this is not possible, patients should be counselled against contact with patients with varicella or zoster as well as being advised to seek medical help immediately if contact occurs. Where the patient has no immunity and significant exposure has occurred, measures should be taken to prevent or attenuate the infection (see below). Significant exposure has been defined arbitrarily by the American Academy of Pediatrics and by the UK Joint Committee on Vaccination and Immunization. Broadly there is consensus that significant contact constitutes living in the same house as a case of zoster or chickenpox, indoor contact with a case of zoster or chickenpox for a period of time (15 minutes or more in the UK) and face-to-face contact with a case of chickenpox.

There are no data on the efficacy of acyclovir prophylaxis in the immunocompromised.

Herpes Zoster

The main aims of therapy in acute herpes zoster occurring in a previously healthy individual, are to heal the rash rapidly, alleviate acute pain, prevent postherpetic neuralgia and reduce the risks of ophthalmic and neurological complications.

Antiviral Drugs

Several drugs are currently licensed for use in the UK for treatment of acute shingles, including topical idoxuridine, acyclovir, famciclovir and valaciclovir. Idoxuridine was the first antiviral drug to be

used for this purpose. It is too toxic to be used systemically but can be administered topically as a 40% suspension in dimethyl sulphoxide. This form of treatment is cumbersome and has now been replaced by systemic or oral treatment with the newer antiviral compounds.

Patients given high-dose acyclovir (800 mg orally 5 times per day) for acute shingles have been shown, in placebo controlled studies, to have faster resolution of the rash (by up to 2 days), have less acute pain, reduced viral shedding (by 1–3 days) and fewer ophthalmic complications. Several studies have also shown a reduction in the incidence, severity and duration of persistent ZAP in those most at risk, i.e. over the age of 55 years, when acyclovir is given within 72 hours of the onset of rash. Valaciclovir (a prodrug of acyclovir) and famciclovir (a prodrug of penciclovir) give higher blood levels of the active drug, and thus allow easier treatment regimens, on account of their improved oral bioavailability. In addition, penciclovir, and its derivative famciclovir, have a significantly longer intracellular half-life compared to acyclovir. A dosing schedule of famciclovir of 250 mg three times a day is as effective as high-dose acyclovir for treatment of zoster. The newer prodrugs also have the potential to prove more effective than acyclovir in reducing the severity and duration of ZAP (Beutner *et al.*, 1995; Cirelli *et al.*, 1996).

Other new drugs which have been developed for the treatment of zoster include sorivudine (BVaraU) and brivudin (BVDU). Both these agents are particularly active against VZV when taken orally, and result in accelerated rash healing; however, neither appear to affect prolonged ZAP (Gnann *et al.*, 1998). Furthermore, when administered in combination with 5-fluorouracil, sorivudine has caused the deaths of a number of patients.

Adjunctive Treatment

Oral prednisolone in addition to acyclovir slightly reduces acute symptoms but does not protect against prolonged ZAP more than acyclovir alone. Other treatments, such as sympathetic nerve blocks and amitriptyline given acutely, have been reported anecdotally to reduce pain and require proper trials to assess adequately.

Treatment of Established ZAP

During the acute attack of zoster, mild opiate analgesics are recommended. If pain persists beyond 4–6 weeks after the rash, patients can be tried on low dose tricyclic antidepressants such as amitriptyline. Other recommendations for pain relief include topical measures such as ice packs, capsaicin, acupuncture and occasionally local injection of sensitive nerves. Patients with intractable pain should be referred for specialist pain management advice.

Ophthalmic Zoster

Management of patients with ophthalmic zoster should include topical acyclovir applied to the eye and oral acyclovir (800 mg 5 times per day), whatever the patient's age. Treatment should however be started as soon as possible to be effective and preferably within 72 hours of onset. It is currently not known how effective acyclovir or the newer antivirals are in treating chronic complications such as anterior uveitis and stromal keratitis. Early referral of patients with ophthalmic zoster to an ophthalmologist is desirable and topical steroids should in no case be administered without specialist consultation.

Herpes Zoster in Immunocompromised Patients

The more severe, and particularly the disseminated, forms of herpes zoster are seen in those who are immunocompromised and may be life or sight threatening. Patients at high risk should be educated to recognize shingles and to seek medical advice early. Highly immunocompromised patients should initially receive intravenous acyclovir, followed by oral acyclovir if necessary. Treatment should be continued until the lesions crust, approximately 5–7 days later. Less severely immunocompromised patients with localized shingles can be given oral acyclovir.

Antiviral Drug Resistance

VZV resistance to acyclovir has been described in immunocompromised patients, in particular those infected with HIV. There is currently no evidence that such resistant virus strains are transmissible but they can present a considerable challenge to

treatment and are therefore of much concern. Almost all the resistant strains which have been characterized to date have had reduced thymidine kinase (TK) function as a result of mutations in the TK gene (Talarico *et al.*, 1993). These mutations have been either deletions or point mutations leading to a truncated TK protein, or single point mutations leading to amino acid substitutions. Mutations involved in resistance to acyclovir have been demonstrated in different positions in the gene and are not only restricted to the ATP or nucleotide binding sites on the protein. Some acyclovir-resistant strains have also been shown to be cross-resistant to other TK-dependent drugs, including penciclovir and sorivudine. However, such resistant strains are generally found to be sensitive to foscarnet, a broad-spectrum antiviral drug which directly inhibits viral DNA polymerase and thus provides an alternative treatment. AIDS patients with acyclovir-resistant VZV infections have been successfully treated with foscarnet (40 mg kg⁻¹ every 8 hours in a 1 hour infusion over 10 days) in an open study (Safrin *et al.*, 1991) but the optimal dose and duration of treatment are not yet defined. Furthermore, a small number of drug-resistant VZV isolates have been identified which have an altered DNA polymerase.

PREVENTION

The prevention of varicella forms an important part of the overall management of VZV disease in those who are at risk of contracting the severe forms of the disease. An increase in adult susceptibility to varicella (see above, Epidemiology) also has serious implications for hospital infection control, since medical staff without immunity may become infected following contact with zoster patients and can, sometimes with disastrous consequences, transmit the infection to patients who are immunocompromised.

Many immunocompromised patients will cope normally with varicella but the possibility of administering VZIG and/or antiviral drugs prophylactically to these patients should always be considered if they come in contact with VZV. At the moment there is, unfortunately, no means of preventing herpes zoster.

Antiviral Drugs

Acyclovir is now routinely used for prophylaxis against HSV infections in immunocompromised patients and may also provide some benefit against VZV. However, studies have not yet been performed to demonstrate the efficacy of such a strategy. Oral acyclovir has been shown to prevent or modify varicella in young immunocompetent household contacts given a 7 day course (40 mg kg⁻¹ in divided doses) beginning 7–9 days after the contact with the index case, i.e. during the presumed phase of secondary viraemia. Administration within 7 days following contact, i.e. during primary viraemia, was not as effective, possibly because early priming of T cells is reduced.

Passive Immunization

Human immunoglobulin preparations with high titres of antibody to VZV are an established means of attempting to prevent varicella. Such preparations were originally prepared by cold ethanol precipitation from the blood of patients recovering from shingles and were consequently designated zoster immunoglobulin (ZIG). Current preparations are obtained by processing preselected sera from blood donors with high titres of antibody to VZV. These preparations are referred to as varicella zoster immune globulin (VZIG) or human anti-varicella zoster immunoglobulin. VZIG preparations are frequently in short supply but antibody concentrations in the blood as high as those with VZIG have been obtained with intravenous normal human immunoglobulin (iv-NHIG) preparations and these may be used empirically as an alternative when VZIG is not available. However, nothing is known about the effectiveness of iv-NHIG. NHIG given intramuscularly has been shown not to be effective and plays no role in prevention of varicella.

VZIG is recommended for any susceptible 'at risk' individual (Table 2B.4) who has *significant* exposure to varicella or herpes zoster. It should be administered as soon as possible after contact, preferably within 96 hours, although some studies have shown VZIG to have a beneficial effect when given up to 10 days after contact. The immune status of the patient should be assessed by testing for specific antibodies in the serum before adminis-

Table 2B.4 Underlying or associated conditions which place patients at risk of contracting the severe forms of varicella

Leukaemias, Hodgkin's disease and other neoplasms of the lymphoreticular system, whether or not treatment is being given
Other cancers which are being treated with cytotoxic drugs or other regimens which are immunosuppressive
Primary immunodeficiency syndromes
Bone marrow transplant recipients irrespective of their own or the donors' VZV status
Diseases requiring systemic steroids at a dosage equivalent to at least 2 mg prednisone per kg per day
Susceptible pregnant women in close contact with VZV
Newborn infants of women who contracted varicella \leq 7 days before or after delivery
Premature infants whose mothers have no history of varicella or any infant whose birth weight was $<$ 1000 g

tration of VZIG whenever possible. Since tests with the appropriate sensitivity (see above, Diagnosis) are generally only available in specialist laboratories, the administration of VZIG should not be delayed past 7 days after the initial contact while waiting for the test result. A convincing history of varicella or zoster is a reasonably reliable indicator of immunity and usually obviates the need to administer prophylactics. Nevertheless, it is recommended that an antibody test is performed to confirm the immune status in immunocompromised patients even if a past history of VZV infection is given. Recipients of bone marrow transplants should be assumed to be susceptible regardless of past history of varicella because of their severe degree of immunosuppression.

The true efficacy of VZIG has not been established in well-controlled trials and differences in the results of different studies may reflect different potencies of the preparations used. It is known that VZIG gives incomplete protection against infection. In a study carried out in the UK it was shown that of 27 seronegative children who were in contact at home, 18 (67%) became infected—14 (52%) with symptoms—in spite of receiving VZIG. Therefore, the rationale for administering VZIG to those at risk is not so much to prevent infection but to prevent the serious forms of the disease with visceral involvement. There are numerous studies, based on case-series, showing the beneficial effects of VZIG in reducing morbidity and mortality compared to historic controls or untreated patients. Unfortunately, there are also reports of correctly administered VZIG failing to prevent fatal varicella in im-

munocompromised patients. Feldman and Lott (1987) reviewed the impact of varicella in 280 children with cancer and the effectiveness of various forms of management. In their study group, passive immunization significantly reduced both the incidence and mortality of pneumonitis compared to untreated children. Even so, pneumonitis developed in 11% of children who received VZIG, requiring intensive additional antiviral chemotherapy.

It is important, particularly in a hospital environment, to be aware of the shortcomings of VZIG and to be alert to the possibility that an inoculated patient might develop varicella and become a source of infection for others.

It is also recommended that VZIG be given to susceptible pregnant women in close contact with VZV infection at any stage of the pregnancy in the hope that it will reduce the risk of transmission of infection to the fetus, and also to ameliorate any potentially serious VZV disease which can occur in pregnant women. Maternal varicella can still occur despite VZIG prophylaxis but a large prospective study has shown that, even in such cases, the risk of fetal infection during the first 20 weeks of pregnancy, and subsequent fetal damage, may be reduced (Enders *et al.*, 1994). Should a woman contract varicella perinatally it is important to administer VZIG to the newborn baby (Table 2B.4).

The recommended dosage for VZIG preparations available in the UK is as follows: 0–5 years, 250 mg; 6–10 years, 500 mg; 11–14 years, 750 mg; and 15 years or more 1000 mg. A second dose can be given after 3 weeks if necessary.

Active Immunization

Although individual cases of varicella may be prevented or modified by VZIG or with antiviral drugs, control of varicella in the community can only be achieved by widespread vaccination. Active immunization also has the advantage in individual 'at risk' patients by offering long-term protection. Varicella vaccines based on the attenuated Oka strain of VZV have been available since 1974 when it was first developed in Japan (Takahashi *et al.*, 1974). The original vaccine was derived from VZV isolated from vesicles of a 3-year-old child with typical varicella and was attenuated by serial passage in guinea-pig cells and human embryo lung

cells. Since its development, the live attenuated varicella vaccine has been shown to be safe and clinically effective for the prevention of varicella in healthy children and adults, as well as in immunocompromised children with leukaemia or other malignancies.

The potential benefits of varicella vaccine in immunocompromised children are considerable and the vaccine is licensed in several European countries for this purpose, although in the UK it is so far only available on a named patient basis. The experience in immunocompromised patients (Kangro, 1990) has shown that:

- The vaccine is generally well tolerated in children with cancer, provided the recommended guidelines about its use are adhered to. Between 5 and 15% of recipients develop a very mild varicella rash, depending on the level of immunosuppression. It is worth noting that transmission of vaccine virus has been documented from the vaccinees who develop a rash.
- Between 70 and 95% of the vaccinees seroconvert but the levels of antibody are appreciably lower than those observed after wild virus infection or in healthy vaccine recipients. Antibody responses persist in the majority of vaccinees for at least 6–10 years but some vaccinees lose detectable antibody after periods of time which vary from 6 months up to 3 years. For this reason, it is advisable to monitor regularly the immune status of vaccine recipients, and if necessary administer a booster vaccination.
- The vaccine confers significant protection, even in those with waning antibody responses. Break-through infections have been reported in 10–15% of vaccinees after close contact but they have always been mild.
- The vaccine is potentially useful for postexposure prophylaxis, although it is generally not licensed for this purpose. Antibody responses usually do not appear until 3–5 weeks after vaccination but cell-mediated immune responses develop within 4 days after vaccination in approximately 50% of recipients and it has been shown in controlled trials to confer protection after contact.
- The vaccine virus can undoubtedly establish latent infection in some vaccinees and reactivate to cause zoster. All the evidence to date shows that this occurs less frequently and is less severe than with wild-type virus.

Increasing awareness of the seriousness of varicella in adolescents and adults, as well as the growing number of susceptible individuals at risk of severe disease, have encouraged serious consideration of the wider use of the vaccine in the community for control of varicella. The vaccine could undoubtedly be of significant benefit in individual adolescents and adults without a past history of varicella, especially those at increased risk of contracting or spreading the infection, such as healthcare workers, and such a policy has recently been recommended by the World Health Organization.

Routine childhood immunization against varicella is also a distinct possibility and is already recommended in some industrialized countries. Varicella vaccine was licensed in the USA in 1995 for use in susceptible healthy persons over the age of 12 months and routine vaccination of healthy children has been practised in Japan and Korea since 1987. The benefits of mass vaccination of healthy children are currently debated, and supported by the positive results of extensive safety, efficacy and cost-effectiveness analyses. The experience in healthy children has shown that 95% or more of susceptible recipients develop humoral and cellular responses following a single dose of the vaccine. Less than 5% of recipients develop a mild, varicella-like rash after vaccination but fever is rare. Excellent protective efficacy has been demonstrated in both uncontrolled and controlled studies showing 100% protection against severe varicella and at least 86% protection against any form of disease following close contact (Izurieta *et al.*, 1997). Antibody levels decline with time but long-term follow-up studies spanning 20 years in Japan and 10 years in USA have shown that over 90% of vaccinated children retain protective immunity. Interestingly, the immune response to varicella vaccine is relatively poor in adults, compared to healthy children, and it has been suggested that this is related to a common defect which predisposes adults to more severe disease following natural infection with VZV. Concerns have been raised about the duration of protection against VZV in the absence of natural exposure to the virus and the possibility of a shift in the epidemiology of varicella into older age groups as a result of a childhood immunization programme. Trials with combined varicella–measles–mumps–rubella vaccines are currently under way and, if successful, will undoubtedly make the acceptance of routine immunization of children easier.

There is also considerable interest in the possibility of vaccinating seropositive adults with the aim of preventing zoster. This arises from the observation that the vaccine effectively can boost both antibody levels and cell-mediated immunity in elderly patients (Sperber *et al.*, 1992).

REFERENCES

- Adams, S.G., Dohner, D.E. and Gelb, L.D. (1989) Restriction fragment differences between the genomes of the Oka varicella vaccine virus and American wild-type varicella-zoster virus. *Journal of Medical Virology*, **29**, 38–45.
- Arvin, A.M., Sharp, M., Smith, S. *et al.* (1991) Equivalent recognition of a varicella-zoster virus immediate early protein (IE62) and glycoprotein 1 by cytotoxic T lymphocytes of either CD4 or CD8 phenotype. *Journal of Immunology*, **146**, 257–264.
- Beutner, K.R., Friedman, D.J., Forszpaniak, C. *et al.* (1995) Valaciclovir compared with acyclovir for improved therapy for herpes zoster in immunocompetent adults. *Antimicrobial Agents and Chemotherapy*, **39**, 1546–1553.
- Carrington, D. and McKendrick, M.W. (1998) Varicella supplement 1998 and consensus guidelines for management. *Journal of Infection*, **36** (suppl. 1), 1–83.
- Choo, P.W., Donahue, J.G. and Manson, J.E. (1995) The epidemiology of varicella and its complications. *Journal of Infectious Diseases*, **172**, 706–712.
- Cirelli, R., Herne, K., McCrary, M. *et al.* (1996) Famciclovir: review of clinical efficacy and safety. *Antiviral Research*, **29**, 141–151.
- Culbertson, W.W., Blumenkranz, M.S., Pepose, J.S. *et al.* (1986) Varicella-zoster virus is a cause of the acute retinal necrosis syndrome. *Ophthalmology*, **93**, 559–569.
- Davison, A.J. (1991) Varicella-zoster virus. *Journal of General Virology*, **72**, 475–486.
- Davison, A.J. and McGeoch, D.J. (1986) Evolutionary comparisons of the S segments in the genomes of herpes simplex virus type 1 and varicella-zoster virus. *Journal of General Virology*, **67**, 597–611.
- Dunkle, L.M., Arvin, A.M., Whitley, R.J., *et al.* (1991) A controlled trial of acyclovir for chickenpox in normal children. *New England Journal of Medicine*, **325**, 1539–1544.
- Enders, G., Miller, E., Craddock-Watson, J.E. *et al.* (1994) The consequences of chickenpox and herpes zoster in pregnancy; a prospective study of 1739 cases. *Lancet*, **343**, 1548–1551.
- Fairley, C.K. and Miller, E. (1996) Varicella-zoster virus epidemiology—a changing scene. *Journal of Infectious Diseases*, **174** (suppl. 3), S314–319.
- Feldmann, S. and Lott, L. (1987) Varicella in children with cancer: impact of antiviral therapy and prophylaxis. *Pediatrics*, **80**, 465–472.
- Furuta, Y., Takasu, T., Suzuki, S. *et al.* (1997) Detection of latent varicella-zoster virus infection in human vestibular and spiral ganglia. *Journal of Medical Virology*, **51**, 214–216.
- Gilden, D.H., Wright, R.R., Schneck, S.A. *et al.* (1994) Zoster sine herpette, a clinical variant. *Annals of Neurology*, **35**, 530–533.
- Gnann, J.W. Jr, Crumpacker, C.S., Lalezari, J.P. *et al.* (1998) Sorivudine versus acyclovir for treatment of dermatomal herpes zoster in human immunodeficiency virus-infected patients: results from a randomized, controlled clinical trial. Collaborative Antiviral Study Group/AIDS Clinical Trials Group, Herpes Zoster Study Group. *Antimicrobial Agents and Chemotherapy*, **42**, 1139–1145.
- Grose, C. (1987) Varicella-zoster virus: pathogenesis of the human disease, the virus and viral replication, and the major viral glycoproteins and proteins. In *Natural History of Varicella-Zoster Virus* (ed. R.W. Hyman), chap. 1, CRC Press, Boca Raton FL.
- Hanshaw, J.B., Dudgeon, J.A., and Marshall, W.C. (1985) Varicella-zoster infections. In *Viral Diseases of the Fetus and Newborn*, p 161. W.B. Saunders, Philadelphia.
- Harper, D.R., Kangro, H.O. and Heath, R.B. (1988) Serological responses in varicella and zoster assayed by immunoblotting. *Journal of Medical Virology*, **25**, 387–398.
- Harper, D.R., Sanders, E.A. and Ashcroft, M.A. (1995) The varicella-zoster virus assembly protein p32/p36 is present in DNA-containing as well as immature capsids. *Journal of Medical Virology*, **46**, 144–147.
- Hawrami, K., Harper, D. and Breuer, J. (1996) Typing of varicella zoster virus by amplification of DNA polymorphisms. *Journal of Virological Methods*, **57**, 169–174.
- Izurietta, H.S., Strebel, P.M. and Blake, P.A. (1997) Postlicensure effectiveness of varicella vaccine during an outbreak in a child care centre. *JAMA*, **278**, 1495–1499.
- Kangro, H.O. (1990) Varicella vaccine. *Reviews in Medical Microbiology*, **1**, 205–212.
- Kennedy, P.G., Grinfeld, E. and Gow, J.W. (1998) Latent varicella-zoster virus is located predominantly in neurones in human trigeminal ganglia. *Proceedings of the National Academy of Sciences of the USA*, **95**, 4658–4662.
- Mahalingam, R., Wellish, M., Cohrs, R. *et al.*, (1996) Expression of protein encoded by varicella-zoster virus open reading frame 63 in latently infected human ganglionic neurones. *Proceedings of the National Academy of Sciences of the USA*, **93**, 2122–2124.
- Marsh, R.J. (1976) Ophthalmic herpes zoster. *British Journal of Hospital Medicine*, **15**, 609–618.
- Nikkels, A.F., Rentier, B. and Pierard, G.E. (1997) Chronic varicella-zoster skin lesions in patients with human immunodeficiency virus are related to decreased expression of gE and gB. *Journal of Infectious Diseases*, **176**, 261–264.
- Ooi, P.L., Goh, K.T., Doraisingham, S. *et al.* (1992) Prevalence of varicella-zoster virus infection in Singapore. *Southeast Asian Journal of Tropical Medicine and Public Health*, **23**, 22–25.
- Pastusak, A.L., Levy, M., Schick, B. *et al.* (1994) Outcome after maternal varicella infection in the first 20 weeks of pregnancy. *New England Journal of Medicine*, **330**, 901–905.
- Pumphrey, C.Y. and Gray, W.L. (1995) DNA sequence of the simian varicella virus (SVV) gH gene and analysis of the SVV and varicella-zoster gH transcripts. *Virus Research*, **38**, 55–70.
- Rowbotham, M.C. and Fields, H.L. (1996) The relationship of pain, allodynia and thermal sensation in post-herpetic neuralgia. *Brain*, **119**, 347–354.
- Safrin, S., Berger, T.G., Gilson, I. *et al.* (1991) Foscarnet therapy in five patients with AIDS and aciclovir-resistant varicella-zoster virus infection. *Annals of Internal Medicine*, **115**, 19–21.
- Sperber, S.J., Smith, B.V., and Hayden, F.G. (1992) Serologic response and reactogenicity to booster immunization of healthy seropositive adults with live or inactivated varicella

- vaccine. *Antiviral Research*, **17**, 213–222.
- Takada, M., Suzutani, T., Yoshida, I. *et al.* (1995) Identification of varicella-zoster virus strains by PCR analysis of three repeat elements and a PstI-site-less region. *Journal of Clinical Microbiology*, **33**, 658–660.
- Takahashi, M., Otsuka, T., Okumo, Y. *et al.* (1974) Live vaccine used to prevent the spread of varicella in children in hospital. *Lancet*, **ii**, 1288–1290.
- Talarico, C.L., Phelps, W.C. and Biron, K.K. (1993) Analysis of the thymidine kinase genes from acyclovir-resistant mutants of varicella-zoster virus isolated from patients with AIDS. *Journal of Virology*, **67**, 1024–1033.
- Wallace, M.R., Bowler, W.A., Murray, N.B. *et al.* (1992) Treatment of adult varicella with oral acyclovir. A randomized, placebo-controlled trial. *Annals of Internal Medicine*, **117**, 358–363.
- Weller, T.H., Witton, H.M. and Bell, E.J. (1958) The etiological agents of varicella and herpes zoster. Isolation, propagation and cultural characteristics *in vitro*. *Journal of Experimental Medicine*, **108**, 843–863.
- Wilkins, E.G.L., Leen, C.L.S., McKendrick, M.W. *et al.* (1998) Management of chickenpox in the adult. *Journal of Infection*, **36** (suppl. 1), 49–58.
- Wilson, A., Sharp, M., Koropchak, C.M. *et al.* (1992) Subclinical varicella-zoster virus viremia, herpes zoster, and T lymphocyte immunity to varicella-zoster viral antigens after bone marrow transplantation. *Journal of Infectious Diseases*, **165**, 119–126.
- Zhu, Z., Gershon, M.D., Ambrose, R. *et al.* (1995) Infection of cells by varicella-zoster virus: inhibition of viral entry by mannose-6-phosphate and heparin. *Proceedings of the National Academy of the USA*, **92**, 3546–3550.

Cytomegalovirus

Paul D. Griffiths

Royal Free and University College Medical School, London, UK

INTRODUCTION

Cytomegalovirus (CMV) infections were first described in the early years of the twentieth century when the typical owl's eye intranuclear inclusions were found by histopathologists in tissues from fetuses stillborn following cytomegalic inclusion disease. These strange inclusions were thought to result from a protozoan infection and, in 1910, one group of workers even proposed the name *Entamoeba mortinatalium* for the supposed agent. In the 1920s, the similarity of the inclusions to those produced by varicella were noted and the guinea-pig form of CMV was transmitted by salivary gland extracts passed through a Berkefeld N filter. Despite these two pieces of evidence suggesting a viral aetiology, reports were still occurring in the late 1940s attributing the disease to a strange protozoan infection. In 1956, three laboratories simultaneously isolated CMV, having successfully developed cell culture technology, so that the true nature of the infectious agent was apparent. One of these three investigators, Weller, gave the virus its name from the effects produced in cell culture, so CMV is named after its cytopathic effect.

THE VIRUS

Morphology

Electron micrographs of CMV reveal a typical herpesvirus appearance (Figure 2C.1). The central

DNA-containing core is surrounded by a capsid composed of 162 capsomeres, each of which is a hollow hexagon in cross-section. The capsid is in turn surrounded by a poorly demarcated area, the tegument, which is itself surrounded by a loosely applied envelope.

When CMV is propagated in cell cultures, two additional morphological forms are produced from the virus-specific proteins and envelope. The first is termed a 'dense body' and appears as a large amorphous structure without nucleocapsid or DNA. The second has been termed a 'non-infectious enveloped particle' and consists of an empty capsid surrounded by a lipid envelope.

Nucleic Acid

CMV contains 235 kb double-stranded DNA. The structure of the DNA is similar to that of herpes simplex virus (HSV) in that long and short unique sequences are bounded by terminally repetitive segments. Each long and short sequence can be orientated in one of two directions so that four DNA isomers are produced by cells in culture. The whole genome of strain AD169 has been sequenced (Chee *et al.*, 1990). The genes are numbered according to their relative positions on one of these four isomers, termed the prototype configuration. By international agreement, the proteins they encode are designated by *p* (for protein); *gp* (glycoprotein); or *pp* (phosphoprotein), followed by the gene number. This formal terminology may then be followed by a

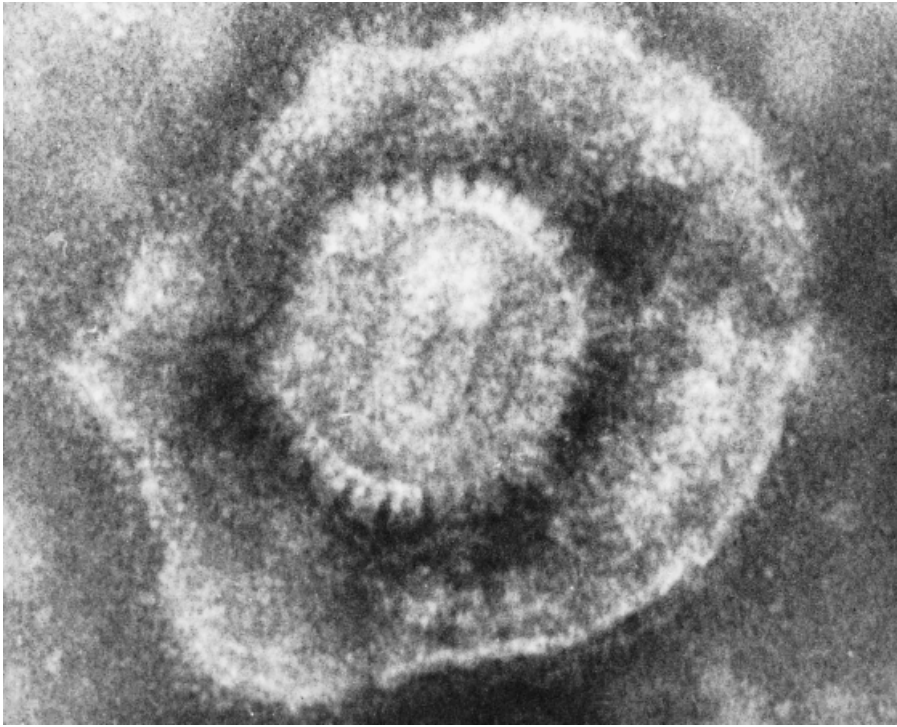

Figure 2C.1 Typical electron microscope appearance of cytomegalovirus. (Photograph kindly prepared by Mr J.A. Bishop)

trivial name, e.g. *gpUL75 (gH)* is glycoprotein H, the product of gene number 75 in the unique long region.

Productively infected cells produce linear genomes from concatameric precursors. Cleavage is accomplished by an endonuclease (terminase) coincident with this packaging. *pUL89* is part of this complex, and there are thus similarities between the cleavage/packaging of herpesvirus DNA and that of bacteriophage T4, which are supported by sequence conservation of the terminase genes. The physical state of the CMV genome at other replicative stages remains poorly defined. For example, it is not known whether, during latency, the CMV genome is integrated into host cell DNA or whether, like *Epstein-Barr virus (EBV)*, it exists in an episomal form.

Some areas of the genome are homologous with regions of human chromosomal DNA, which has practical importance for selection of CMV DNA probes. Distinct transforming regions of DNA have been identified. One is adjacent to the major immediate-early region which encodes transactivator

proteins, but recent work suggests that the transforming activity is distinct (Wang and Razzaque, 1993). While such experiments are interesting, it must be emphasized that, at present, there is no evidence that CMV is naturally oncogenic.

The DNA can be digested with restriction endonucleases so that, following gel electrophoresis, oligonucleotide patterns characteristic of distinct CMV strains are produced. This technique cannot prove that two strains are identical but if strains fail to show different patterns after digestion with at least two restriction endonucleases then it is very likely that they are identical (Huang *et al.*, 1980). Use of restriction enzyme analysis can provide useful epidemiological information, but there is no evidence to suggest that any one strain is associated with any particular type of clinical presentation.

Genetic changes also occur in the genome without acquisition of new cleavage sites for commonly used restriction enzymes. The polymerase chain reaction (PCR) followed by sequencing can be used to explore genetic variation at the fine molecular level for particular regions of interest.

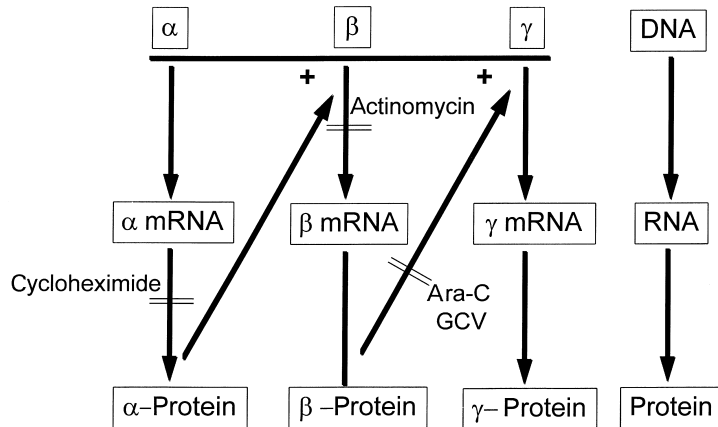

Figure 2C.2 Cascade genome expression of herpesviruses. Genes labelled α (immediate-early), β (early) or γ (late) are transcribed into messenger RNA and then translated into proteins. Inhibitors of protein synthesis (cycloheximide), transcription (actinomycin D) or DNA replication (cytosine arabinoside (ara-C) or ganciclovir (GCV)) can be used to interrupt genome expression, as discussed in the text

Control of Genome Expression

Expression of the CMV genome is controlled by a cascade synthesis of proteins. The first proteins to be synthesized (α or immediate-early) are required for the transcription of the messenger RNA (mRNA) for the second group of proteins (β or early). The early proteins allow DNA replication to proceed and this is followed by the appearance of the last proteins (γ or late). This cascade sequence is depicted in Figure 2C.2, which also shows the stages at which metabolic inhibitors can be employed to manipulate the cascade. If cell cultures are prepared and infected with CMV in the presence of an inhibitor of protein synthesis, then relatively large concentrations of α -mRNA will build up behind the metabolic block. When this block is released by refeeding the cultures, synthesis of α -proteins will occur within minutes. To prevent α -proteins inducing β -mRNA and then β -proteins, inhibitors of transcription should be incorporated into the refeeding medium. To allow β -protein expression without inducing γ -proteins, the cultures can be refed with an inhibitor of DNA synthesis. Finally, fresh medium without added inhibitors can be used to induce the cells to produce γ -proteins. It should be emphasized that this cascade synthesis dictates that at each time after infection the appropriate proteins, together with their preceding proteins, are present in the infected cells. It is therefore not possible

to produce cells containing only β -proteins or only γ -proteins by means of infection; to achieve this, individual genes must be cloned and expressed separately. Note that some γ -genes are transcribed at early times but are only translated after DNA replication has occurred. These are sometimes termed 'leaky-late' genes to differentiate them from true late genes which are only transcribed after DNA replication. Recently, some transcripts which map in both sense and antisense orientation to the major immediate-early region of CMV have been described (Kondo *et al.*, 1996). Some of these have unique expression at immediate-early and late times and so have been classified as λ -genes.

The mechanism(s) which control genome expression are not fully understood. Certainly, there is no evidence for a canonical sequence upstream of β -genes which could be activated directly by α -proteins. This suggests that α -proteins mediate their effects through activation of endogenous transcriptional factors. Cellular transcription factors such as SP1 and NF κ B have been implicated so far.

Some control of expression is also exerted at the translational level. The DNA polymerase (*pUL54*) has an untranslated leader region which suppresses translation (Ye and Huang, 1993). Furthermore, the presence of upstream AUG codons, which, according to the ribosome scanning hypothesis allow production of short peptides in preference to the authentic proteins, appears to restrict early expression of some transcribed leaky-late mRNA.

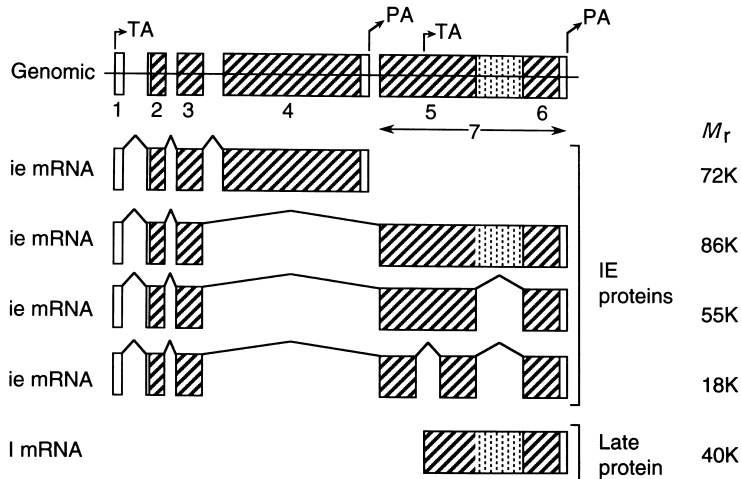

Figure 2C.3 Proteins encoded within the major immediate-early region of CMV. Exons are numbered 1–7. TA = transcriptional activation; PA = polyadenylation; ie = immediate-early; l = late

The cascade synthesis of CMV is similar to that of HSV but is temporally regulated in a different manner. While α - and β -protein synthesis occurs at roughly the same times in cells infected with HSV or CMV, DNA synthesis in HSV-infected cells follows promptly the appearance of β -proteins, whereas, in CMV-infected cells, it is delayed. DNA synthesis also progresses slowly so that the production of CMV γ -proteins and their incorporation into daughter virions occurs many hours later than in HSV-infected cells.

Proteins

The CMV genome is sufficiently large to encode over 200 proteins of average size, and sequencing of one strain has identified 204 predicted open reading frames (Chee *et al.*, 1990). Of these, approximately 189 may be unique proteins, since others are found in duplicate in the repeat regions of the genome.

One expression unit has been studied in great detail: that encoding the major immediate-early (MIE) proteins of CMV. As shown in Figure 2C.3, this genetic unit is expressed via differential splicing to produce four α -proteins of distinct M_r . The protein of M_r 86 000 (*IE86*) interacts with the basal transcriptional machinery, especially the TATA binding protein, to enhance formation of preinitiation complexes (Wu *et al.*, 1993). It also cooperates

with the M_r 72 000 protein to synergistically increase expression of its own, and heterologous, promoters, probably through activation of endogenous transcription factors and/or by bridging between their binding sites and the TATA binding protein (Lukac *et al.*, 1997). The M_r 55 000 protein has minor stimulatory effects, either alone or in combination with either of the other two larger proteins. The smallest protein (M_r 18 000) is expressed during replication in differentiated monocytes (Kerry *et al.*, 1995).

The largest of these proteins downregulates its own synthesis and so is autoregulated (Stenberg and Stinski, 1985). This downregulation is mediated by a distinct region in the C-terminus, which is shown stippled in Figure 2C.3. This region is also present in a late protein embedded within this region of M_r 40 000, and it is likely that activation of its promoter at late times leads to downregulation of the major immediate-early region. *IE86* also binds cellular *p53* which may decrease *p53*-induced apoptosis. *IE86* also interacts with the protein product of *UL84*, which is a transdominant inhibitor of *IE86*. Some of the recently described latency-associated transcripts found in the bone marrow of normal donors code for proteins which are recognized by infected humans (Kondo *et al.*, 1996). Their function is obscure but, by analogy with HSV, they may play important roles in the establishment or regulation of the latent state. Expression was found in multiple tissues of transgenic mice containing a

Table 2C.1 Human CMV envelope glycoproteins

Complex in envelope	Constituent proteins	Mapped ORFs
gCI	gB homodimer	gpUL55
gCII	gM (IMP) Others?	gpUL100
gCIII	gH gL gO	gpUL75 gpUL115 gpUL74

ORF = open reading frame; IMP = intergral membrane protein.

Table 2C.2 Eleven loci required for human CMV replication

DNA- <i>pol</i>	<i>UL54</i>
<i>pol</i> -associated protein	<i>UL44</i>
ssDNA BP	<i>UL57</i>
Helicase-primase	<i>UL70</i> <i>UL105</i> <i>UL101–102</i>
Transactivators	<i>UL36–37</i> <i>IRS1 (or TRS1)</i> <i>IE1/2</i>
Unknown functions	<i>UL84</i> <i>UL112–113</i>

After Pari *et al.* (1993).

lacZ gene under the control of the MIE region which correlated well with the cell types in which CMV replication is found *in vivo* (Baskar *et al.*, 1996). Thus, in summary, expression and regulation of the gene are remarkably complex, with the potential for exquisite control of virus replication.

Other immediate-early genes are of interest. Genes *UL36–37* encode transactivators which are essential for DNA replication and which represent a molecular target for antiviral chemotherapy. Likewise, *TRS1* is required for DNA replication. *pUL69* is present in the tegument of the virion, as is *ppUL82*. Although the latter is a late protein, in combination, these two proteins appear to play a similar role to the α -transinducing factor of HSV which is released into the cell during the process of uncoating and is then able to interact with a cellular transcription factor to upregulate the major immediate-early promoter.

Early proteins mainly provide essential enzymic functions within the cell; for example, *pUL54*, DNA polymerase and *pUL97*; a protein kinase which phosphorylates antiviral nucleosides such as ganciclovir (GCV) or acyclovir (ACV), so starting their anabolism to the functional nucleoside triphosphate inhibitors of *pUL54*.

Late proteins generally play a structural role in

virion formation. For example, surface glycoproteins are potentially important because of their interaction with the immune system. Neutralizing epitopes have been described on *gB* (Basgoz *et al.*, 1992) and *gH* (Urban *et al.*, 1996). *gH* requires *gpUL115* (glycoprotein L) to facilitate surface expression. Much of the neutralizing activity of serum samples can be absorbed by recombinant *gB*, suggesting that this protein contains dominant neutralizing sites (Britt *et al.*, 1990). *gB* forms the active component of some vaccine preparations which have reached the stage of phase I clinical testing. Genetic variation at one of the neutralizing sites has been found in immunocompromised patients with chronic infection, suggesting that these viruses may be antibody-escape mutants evolving under selective pressure from the humoral immune response (Darlington *et al.*, 1991).

Note that an alternative nomenclature system terms *gB* 'glycoprotein complex I' (*gCI*) and *gH* 'glycoprotein complex III' (*gCIII*) (Gretch *et al.*, 1988). The protein products of individual genes which combine to form these complex glycoproteins are summarized in Table 2C.1.

A variety of other proteins have been identified and mapped to the genome (see Figure 2C.4, see Plate I), important examples of which will be mentioned briefly. A total of 11 proteins are required *in trans* to effect replication (Table 2C.2). Many of these perform similar functions to HSV proteins, except that CMV does not have an identified origin binding protein and requires transactivators. *pUL80A* and *pUL80.5* encode the protease and assembly protein, respectively. Protease is responsible for cleaving the original polyprotein at three distinct sites. The assembly protein facilitates formation of B-capsids and entry of DNA, being lost from the capsid in the process. Four genes (*US27*, *US28*, *UL33*, *UL78*) are homologous to G-protein-coupled receptors and so may be involved in signal transduction. The *US28* gene facilitates entry of HIV into CD4+ cells which are otherwise not susceptible to HIV infection (Pleskoff *et al.*, 1997). In addition, open reading frames with predicted similarities to known proteins have been identified from the sequenced genome of *Ad169*. It will be important to determine rigorously that these proteins are actually expressed and that they have the predicted function.

Note also the 22 extra genes depicted outside the main circle. These are not present in *Ad169* but are

found in other strains of CMV with a lower passage history (Cha *et al.*, 1996). Presumably, they have been lost during the process of adapting CMV to grow in fibroblast cell lines which led to the strain termed *Ad169*. This strain is popular with researchers because it grows rapidly to relatively high titre and releases a lot of extracellular virions. Wild strains of CMV lack these properties and so are difficult to work with in the laboratory. As a result, one has to question whether *Ad169* is fully representative of CMV strains *in vivo* and the presumed loss of these 22 genes illustrates this issue. None of the 22 genes has homology with known herpesvirus proteins. Many appear to encode glycoproteins, and vaccine candidates containing these genes are being studied.

Growth *In Vitro*

The only cells fully permissive for CMV replication *in vitro* are human fibroblasts. This finding is in complete contrast to that *in vivo* where, at postmortem examination, cells infected with CMV are found in tissues of epithelial origin (kidney, liver, bile ducts, salivary gland, gut epithelium, lung parenchyma, pancreas) as well as in endothelial cells. This observation again suggests that the virus propagated in the laboratory should not be assumed to be an authentic model of the wild-type virus. The cell surface proteins which act as receptors for CMV have not been identified, although several candidates have been proposed.

In fibroblast cell cultures, encapsidation occurs in the nucleus and the virus envelope is then acquired by budding through the inner nuclear membrane to the Golgi apparatus. Enveloped virions are found within vesicles in the cytoplasm and these appear to fuse with cellular membranes to allow egress of the mature virus particles. Dense bodies also mature in the Golgi apparatus and are released from the infected cell in the same way as virions so that they contain virus-specific glycoproteins.

At late times after infection, CMV induces the appearance in infected fibroblasts of an Fc receptor. It is not clear if this is a virus-encoded protein or whether it represents upregulation of a host gene. Expression of the Fc receptor is blocked by inhibition of DNA synthesis so, if it is virus-encoded, it should be a late gene product. The sequence of the

Ad169 strain does not contain predicted proteins with homology to gE or gI of HSV which form the Fc receptor of that virus. The CMV Fc receptor has high affinity for human IgG, but not other human immunoglobulin isotypes, and has low affinity for rabbit IgG or mouse IgG (Keller *et al.*, 1976). The Fc receptor is found in the Golgi apparatus, which enlarges to form a perinuclear inclusion body in the concavity of the reniform nucleus. It has been suggested that HSV produces an Fc receptor so that antibody attached by its Fab portion to a virus protein can be bound by its Fc portion back onto the virion. This would have the effect of preventing immune effector mechanisms which require an intact Fc portion after opsonization. Whether such a mechanism is operative for CMV remains to be defined. However, the production by CMV of Fc receptors *in vivo* might allow opsonized bacteria or fungi to gain access to cells which they cannot normally infect; this might explain why CMV infection is often associated with secondary bacterial and fungal infections. A similar process might operate for human immunodeficiency virus (HIV) coated in non-neutralizing antibody (McKeating *et al.*, 1990).

Unlike HSV, CMV does not switch off host macromolecular synthesis but actually stimulates cellular DNA, RNA and protein synthesis. One cellular function which is stimulated as a result is thymidine kinase activity. It is tempting to suggest that CMV has learned to increase cellular uptake of thymidine by switching on the host enzyme responsible, while HSV has used a different tactic, the production of a novel thymidine kinase to achieve the same objective. Likewise, CMV induces cellular topoisomerase II and may package this enzyme into extracellular virions. Recent results have also shown that human complement is bound to the virion but not activated. Host cell complement regulatory proteins were detected in virions and might explain this phenomenon (Spiller *et al.*, 1997). Thus, like HIV (reviewed in Ott, 1997), the mature virion may contain host proteins of potential importance for understanding pathogenesis.

EPIDEMIOLOGY

Cytomegalovirus must be acknowledged as one of the most successful human parasites. It has learned to survive in its human host by infecting both verti-

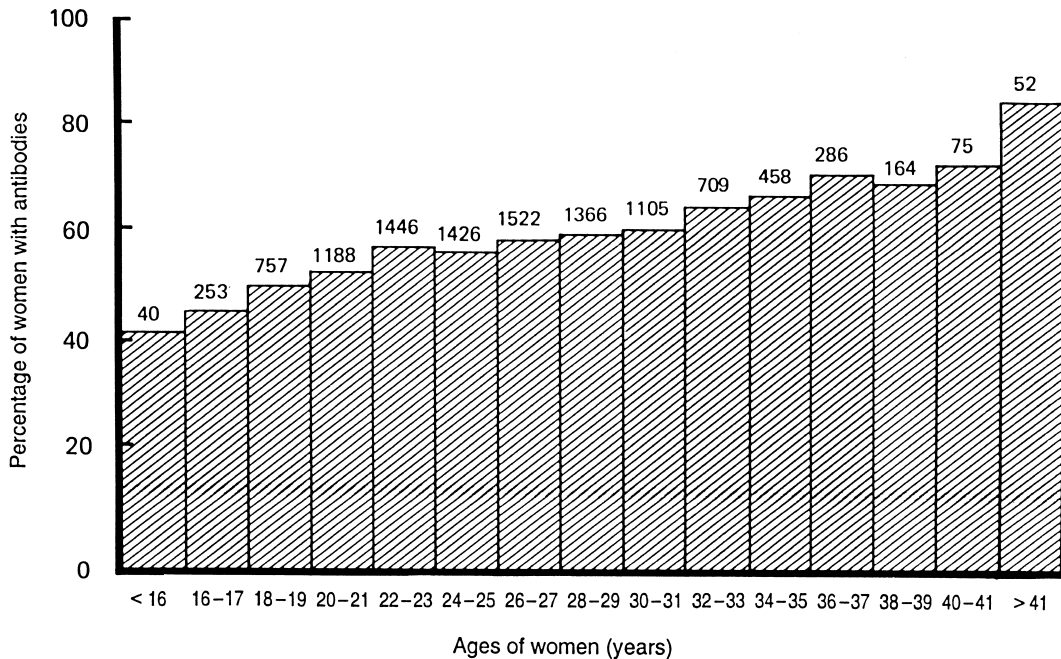

Figure 2C.5 The age-specific prevalence of complement-fixing serum antibodies against cytomegalovirus. The number of women in each age group is shown above each column of the histogram. (Reprinted with permission of Blackwell Science Ltd from Griffiths and Baboonian, (1984))

cally and horizontally; the virus can be transmitted by either route during primary infection, reinfection or reactivation; at all times the virus causes minimal disability, allowing infected individuals to remain active and so maintain the maximum opportunity of encountering susceptible contacts; the virus is excreted from multiple sites, so contact of varying degrees of intimacy can lead to transmission.

Infection may be acquired during delivery, following ingestion of infected maternal genital secretions or soon afterwards by ingestion of breast milk containing CMV (Stagno *et al.*, 1980). These two means of perinatal transmission combine to infect between 2 and 10% of infants by the age of 6 months in all parts of the world.

Throughout the rest of childhood, close contact is known to be required for transmission, although the precise route of infection is not known. As a result, CMV may transmit readily within family groups. The possibilities for infection must be increased where individuals are crowded together in unhygienic circumstances, and this probably explains why CMV infection is most common in societies which are socially disadvantaged. Infection is transmitted less well in the general community,

apart from child-to-child transmission which has been documented in play groups. However infected, children can transmit CMV to their parents (Pass *et al.*, 1986) and so represent a potential threat to a future sibling the mother be pregnant.

In populations of poor socioeconomic background, the vast majority of children have experienced primary CMV infection by the onset of puberty. In countries with good social circumstances, roughly 40% of adolescents have been infected, and, as shown in Figure 2C.5, this increases by approximately 1% per annum thereafter (Griffiths and Baboonian, 1984). Such primary infection can lead to vertical transmission if the individual is pregnant when infected.

The prevalence of CMV IgG antibodies in organ transplant recipients reflects their socioeconomic grouping. The same applies to individuals who acquired HIV infection *via* blood (or blood products), heterosexually or through contaminated needles used for intravenous drug use. In contrast, HIV-positive male homosexuals have a very high prevalence of CMV IgG antibodies (typically 95%).

At whatever age primary infection occurs, the virus is not eradicated from the host but persists for

life. Occasionally, however, CMV reactivates from its latent state and infectious virions appear in the saliva and/or urine. Reactivations of CMV are entirely asymptomatic but form an important means by which CMV can spread horizontally. Reactivations can also lead to vertical transmission of CMV. This finding came as something of a surprise, since it was assumed, by analogy with rubella, that a woman who possessed antibody against CMV before becoming pregnant would be immune to intrauterine transmission. However, not only can reactivation of latent maternal infection lead to congenital infection but more fetuses are infected worldwide by this route than are infected as a result of primary maternal infection. Congenital CMV infection thus has its highest incidence in the poorest communities of the world, since most women in poor societies are infected before reaching child-bearing age. Note, however, that primary CMV infection in the mother represents a greater risk to the fetus than recurrent maternal infection (Fowler *et al.*, 1992).

Finally, 'immune' hosts can also be reinfected with another or, possibly, the same strain of CMV. Epidemiologically, it is important to distinguish between reinfection and reactivation of latent infection but, in clinical practice, the term 'recurrent' infection is often used to cover both possibilities.

ROUTES OF INFECTION

Intrauterine Infection

As is the case with rubella, intrauterine infection is assumed to follow maternal viraemia and subsequent placental infection, although this has not been proven formally. Due to the lack of maternal illness it has not been possible to identify a series of pregnant women with primary CMV infection and show that viraemia is a risk factor for congenital infection. If viraemia is responsible for transmission, then it must be determined whether cell-free virus or leucocyte-associated virus is required for placental infection. Intrauterine transmission of CMV occurs in only one-third of pregnant women with primary infection but we remain ignorant of how the majority prevent the virus from infecting the fetus. It may be that the placenta acts as a form of barrier, but representation of this organ as a sieve

which may or may not trap CMV must surely be simplistic. Recent ultrastructural studies of the placenta emphasize the importance of macrophage-mediated defence against potential virus infections (reviewed in Burton and Watson, 1997).

Perinatal Infection

Perinatal infection is acquired predominantly from one of two sites: infected maternal genital secretions or breast milk.

During delivery, the fetus is surrounded by copious quantities of genital secretions which may contain high titres of CMV as a result of recurrent maternal infection. Under these conditions, infection has been described as occurring 'during passage through the Sea of Cytomegalovirus'.

Breast milk, especially colostrum, has also been shown to be a good source of CMV. Although virus titres are relatively low, large quantities of milk are imbibed, so a heavy viral inoculum can be ingested. Clinical studies have demonstrated that it is not just the presence of CMV in breast milk which is required but that this milk must also be fed. Women whose only site of CMV excretion was from the breast were studied. Perinatal infection occurred only when breastfeeding took place, not when such women gave bottle feeds (Stagno *et al.*, 1980).

Having ingested CMV, infection might be established in the neonate by infection of buccal, pharyngeal, respiratory, salivary gland or oesophageal mucosa or by initiation of infection in the small or even large bowel mucosa. The latter possibilities seem unlikely since CMV is likely to be inactivated by environments containing acid and bile salts.

Postnatal Infection

The absence of symptoms associated with postnatal CMV infection makes it impossible to implicate with certainty the routes of transmission, although evidence exists to support salivary transmission.

Saliva containing CMV has been recovered from toys at daycare centres and this would seem to be an ideal means by which the virus could be transmitted among young children unable to conform to basic standards of hygiene (Pass *et al.*, 1986). Likewise, occasional cases of CMV mononucleosis are seen in

young adults and, by analogy with EBV, the infection has been dubbed a 'kissing disease'.

The prevalence of CMV IgG antibodies in developed countries increases at 1% per annum from puberty to middle age (Figure 2C.5). It is often stated that these infections result from sexual exposure but this remains unproven. Certainly, they result from contact with an infected individual, but whether this contact takes place at the level of oral or genital mucosa is a matter of speculation. Evidence can be found to support the concept of venereal transmission since CMV is found in semen and on the cervix. However, this is only circumstantial evidence; we do not talk of brain-to-brain transmission of poliomyelitis or urinary transmission of mumps just because these viruses may be found at particular sites. Sexual contact is almost invariably preceded by oral-oral contact. Thus, even if CMV is shown to be transmitted by intimate contact, it may have resulted from salivary rather than from venereal exposure. This issue is important because we may need to target CMV vaccines to particular mucosal sites in order to prevent infection.

One setting in which sexual transmission of CMV does occur, however, is from male homosexuals who have a high prevalence of CMV infection. Contacts who are initially seronegative have a high risk of primary infection during follow-up. At least one study has implicated rectal intercourse as an independent risk factor for CMV seroconversion. This suggests that CMV may be transmitted by this route with the rectal mucosa providing a less efficient barrier to the high titres of virus found in semen than is provided by the stratified squamous epithelium of the vagina.

Blood Transfusion

In the early 1960s, when extracorporeal blood perfusion was introduced to facilitate open heart surgery, a syndrome of leucopenia, pyrexia and atypical leucocytosis was recognized which was termed the postperfusion syndrome. In the mid-1960s, Finnish workers showed that the syndrome was attributable to primary CMV infection acquired by blood transfusion.

Transmission of CMV by blood transfusion was first recognized in these patients for three reasons. First, they received large quantities (typically 10 units) of blood both at pump-priming and post-operatively. Second, the blood was transfused to

replenish heat-labile clotting factors and was used as soon as possible after donation, a procedure which would increase the likelihood of transferring viable virus. Third, the patients were being carefully followed up so that the appearance of the new syndrome in convalescence was likely to be recognized.

Although CMV can be transmitted by blood transfusion, it is clear that this is an uncommon event, since only 1–5% of blood units taken from seropositive donors leads to infection of seronegative recipients. To date, it has not been possible to determine which donors have a high risk of transmitting the virus. Attempts to culture CMV from fresh donor blood have been unsuccessful at all centres except one, and the methods used at that centre have not been successful elsewhere. This failure to isolate CMV has led to the suggestion that the virus exists in the blood of healthy donors in a latent state, presumably within leucocytes, and that CMV is reactivated following transfusion when these cells encounter an allogeneic stimulus. This suggestion is plausible but remains controversial, not least because of the failure to isolate CMV from blood donor leucocytes using cocultivation techniques. The nature of the leucocytes in which CMV may establish latency remains unknown, although increasing attention is focusing on the monocyte/macrophage (Söderberg-Naucler *et al.*, 1997). CMV can be grown from the peripheral blood of immunocompromised patients and *pp65* antigen is found in polymorphonuclear leucocytes and macrophages. However, this is clearly a different pathogenetic situation from that found in healthy blood donors and could be the result of the phagocytic scavenging activity of these cells.

Organ Transplantation

Several studies have shown that seronegative patients undergoing renal transplantation can be divided into two risk groups, according to the serological status of the donor. Those receiving a kidney from a seronegative donor have virtually no risk of acquiring primary infection, whereas a seropositive kidney may transmit the virus in 60–80% of cases. Molecular typing of CMV strains excreted by multiple recipients of organs from a single donor proved that the donor organ was the source of CMV (Wertheim *et al.*, 1983). Since both organs from a single donor are usually concordant for transmission, the infectivity must be bilateral;

Table 2C.3 CMV infection and disease at the Royal Free Hospital

Patient type	Pretransplant IgG		No. of patients	No. with CMV	
	R	D		Infection	Disease
Renal transplant	—	—	21	0	0
	—	+	34	21 (62) ^a	15 (44) ^a
	+	—	51	19 (37) ^a	3 (6)
	+	+	71	49 (69) ^a	18 (25) ^a
Bone marrow transplant	—	—	63	4 (6)	2 (3)
	—	+	23	6 (26) ^a	1 (4)
	+	—	25	12 (48) ^a	11 (44) ^a
	+	+	66	33 (50) ^a	8 (12)
Liver transplant	—	—	4	1 (25)	1 (25)
	—	+	3	1 (33)	1 (33)
	+	—	18	2 (11)	2 (11)
	+	+	19	11 (58) ^a	6 (32)

Values in parentheses are percentages.

R = recipient; D = donor.

^aSignificantly different from R — D — group.

either parenchymal cells or infiltrating leucocytes are prime suspects. Interestingly, the same techniques showed that donor virus could also infect seropositive individuals and cause CMV disease (Grundy *et al.*, 1988). Thus, recipient natural immunity acquired prior to immunosuppression cannot prevent CMV infection, a finding which has implications for the development and evaluation of CMV vaccines. Several studies have shown the same results following all types of solid organ transplants, so all organs from seropositive donors should be regarded as potentially infectious.

In contrast, typing of virus strains showed that the virus causing disease after bone marrow transplant is derived from the recipient and not from the donor (Winston *et al.*, 1985). Seropositive donors have been reported to transfer immunity to recipients adoptively (Grob *et al.*, 1987). This has only been reported in recipients of T-cell-depleted marrow, so it may be speculated that this process removes the cells containing CMV while leaving intact immunocommitted non-T cells which can function in the recipient (Table 2C.3).

PATHOGENESIS

Risk Factors for CMV Disease

Comparison of the results from pregnancy, from recipients of solid organ transplants, from bone

marrow transplants and from patients with HIV infection, reveals some interesting parallels, despite the different organs involved in CMV disease (Table 2C.4). Thus, primary infection is a major risk factor during pregnancy and for recipients of solid organ transplants but not for bone marrow transplant or patients with the acquired immune deficiency syndrome (AIDS). Viraemia has been repeatedly shown to be a risk factor following solid organ or bone marrow transplantation (Meyers *et al.*, 1990) and recent results show the same is true for AIDS patients (Bowen *et al.*, 1997; Dodt *et al.*, 1997; Shin-kai and Spector, 1997). A high CMV virus load was initially shown to be important in neonates with congenital infection (Stagno *et al.*, 1975) and more recently in renal transplant (Cope *et al.*, 1997b), liver transplant (Cope *et al.*, 1997a), bone marrow transplant (Gor *et al.*, 1998) and AIDS patients (Bowen *et al.*, 1996). Furthermore, multivariate statistical analyses show that, once virus load in urine has been controlled for as a marker of poor prognosis in renal transplant recipients, other recognized risk factors of viraemia and donor/recipient serostatus are no longer statistically associated with CMV disease (Table 2C.5). This demonstrates that high CMV load is the determinant of CMV disease and that viraemia and donor/recipient serostatus are markers of CMV disease simply because of their statistical association with a high virus load. Similar multivariate studies in liver transplant and bone marrow patients confirm that high CMV load in blood explains the association with donor/recipient

Table 2C.4 Risk factors for CMV disease

Factor	Pregnancy	Solid transplant	Bone marrow transplant	AIDS
<i>Primary infection</i>	+	+	–	–
<i>Viraemia</i>	No data	+	+	+
↑ <i>Load</i>	+	+	+	+

+ Indicates that the factor has been shown to correlate with risk of CMV disease.

Table 2C.5 Univariate and multivariate assessment of prognostic variables for CMV disease after renal transplant

Parameter	Univariate			Multivariate		
	OR	95% CI	P	OR	95% CI	P
Viral load (per 0.25 log)	2.79	(1.22–6.39)	0.02	2.77	(1.07–7.18)	0.04
Viraemia	23.75	(3.69–153)	0.0009	34.54	(0.75–1599)	0.07
Recipient seropositive	0.22	(0.05–0.95)	0.05	0.92	(0.002–446)	0.98

OR = odds ratio; CI = confidence interval.
From Cope *et al.*, (1997b).

serostatus (Cope *et al.*, 1997a; Gor *et al.*, 1998).

All of these results provide insight into the pathogenic stages leading to CMV disease. Figure 2C.6 illustrates the concepts using the flow of water from a tap into a bath with an open drain. This is analogous to virus-infected cells at a peripheral tissue (such as kidney or salivary gland) producing CMV virions. Their number may be controlled by local immune responses (drain) but, if these are inadequate, the number of virions will increase. If they overwhelm the local immune responses, virions will overflow into the systemic circulation, causing viraemia. The same process is then repeated in the target tissue (e.g. liver, retina), whose local immune responses may be able to prevent virus load reaching the critical levels required to cause disease. This explains why viraemia is a strong predictor of CMV disease, but does not guarantee that it will occur. Finally, the model suggests that different cellular mechanisms of pathogenesis may be activated at different virus loads. Thus, immunopathology may be triggered by low virus loads, while high virus loads may be required to damage sufficient cells by lysis to cause clinically recognized disease. Speculatively, some disease may be produced when cells are bombarded with very high virus loads without requiring replication; for example, binding of gB and gH can activate release of transcription factors (Yurochko *et al.*, 1997).

Incubation Periods

Examination of three settings in which the date of infection and date of onset of virus excretion can be reliably predicted gives an estimate of 4–8 weeks for the ‘incubation period’ of primary infection. The three informative clinical settings are where infection is acquired perinatally or is transmitted by organ allograft or blood transfusion.

In contrast, it is not clear whether congenital infection involves a fetal incubation period as well as a maternal one. Maternal seroconversion at different stages of pregnancy has been documented in several studies. For comparison between these studies, the gestational stage is recorded as the duration of pregnancy at which maternal seroconversion occurred. However, even if it is assumed that the placenta is infected following maternal viraemia at the time of seroconversion, it is not known whether the fetus can be infected immediately or whether replication in the placenta provides an intrauterine incubation period before viral dissemination to the fetus can occur. This point is important, because damage to the fetus should relate to developmental maturity when infected, rather than to the length of the mother’s amenorrhoea. This has implications for the timing of diagnostic amniocentesis.

Allograft recipients typically have recurrent

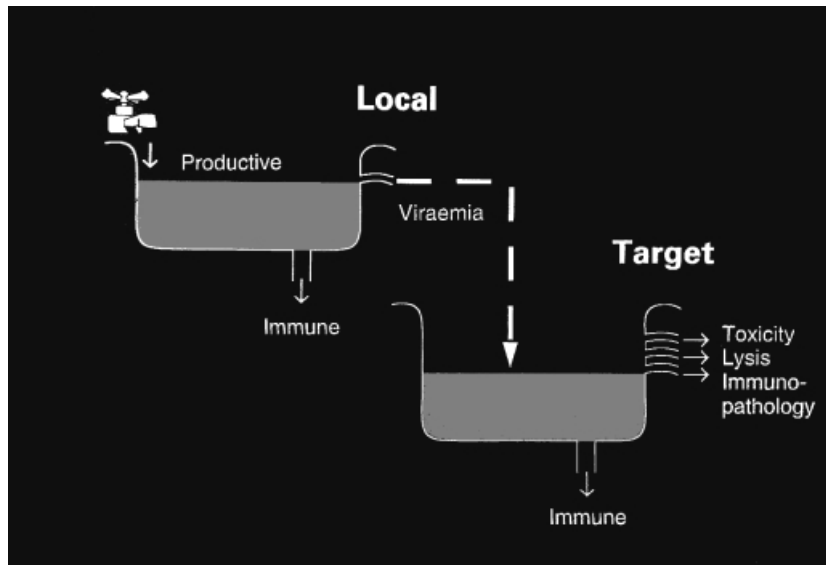

Figure 2C.6 Cartoon illustrating the kinetics of CMV production leading to disease in a target organ. The tap represents production of virions by virus-infected cells. The drain represents the ability of immune responses to control CMV accumulation

CMV infections in the second or third month following transplantation. Recurrent CMV infections in adults seem to be age-dependent. Studies of pregnant and non-pregnant women as well as male homosexuals have shown that up to 10% of seropositive individuals may be excreting CMV from saliva or urine, or from the cervix in females. Excretion rates are, however, very low after the age of 30 years, suggesting that a host response required for suppression may 'mature' at about this age.

Earlier reports showed that virus excretion from the cervix increased as pregnancy progressed. This was interpreted as being a response to some 'immunosuppressive' effect of pregnancy. A later study, however, showed that CMV excretion was actually suppressed during early pregnancy, so the increase seen in virus isolation towards the end of pregnancy only brought the rate up to the level seen in non-pregnant women (Stagno *et al.*, 1975). All studies to date have been cross-sectional rather than longitudinal, so person-to-person differences in CMV excretion could account for the results seen.

Host Defences

In combination, the host defence responses in those with normal immunity keep CMV suppressed into

a latent state in most individuals for most of the time. Abrogation of these responses permits CMV replication with full expression of its potential pathogenicity in some cases. Since severe CMV disease is restricted to individuals with impaired cell-mediated immunity, it can be concluded that this arm of the immune response provides most protection against disease. Nevertheless, the ability of the humoral system to provide a supportive role, especially in keeping CMV viral loads below critical thresholds, should not be dismissed.

Humoral Immunity

Antibodies of IgG class are produced promptly during primary infection and persist for life. IgM class antibodies are produced on primary but not recurrent infection of immunocompetent individuals and persist for 3–4 months. During primary infection immunocompromised patients may fail to produce IgM antibodies, although one-third have IgM responses detectable with recurrent infections. With intrauterine infection, IgM antibodies are produced by the fetus; IgG class responses are also present, but only become detectable as passively acquired maternal IgG antibody is catabolized.

There is evidence to support the concept that the humoral immune response is beneficial to the host. Thus, immunocompromised patients who fail

promptly to produce neutralizing antibodies run a high risk of developing disseminated CMV infection. Likewise, renal transplant recipients experiencing reactivation are unlikely to develop life-threatening illnesses, although patients with primary infection will mostly be symptomatic. Reinfections produce disease severity intermediate between that of primary and reactivated infections. Similarly, intrauterine CMV infection represents less of a risk to a fetus if it has been transmitted by means of recurrent maternal rather than primary maternal infection (Fowler *et al.*, 1992). Women with primary CMV infection who transmit the virus *in utero* have higher levels of total IgG but lower levels of neutralizing antibodies and lower avidity than women who do not transmit (Boppana and Britt, 1995). While all of this information is compatible with the concept that immune responsiveness can be protective, it does not prove that antibody is the beneficial component. For example, cytotoxic T cells may be protective and the ability to mount this response promptly may correlate with the ability to mount a humoral immune response. Likewise, the postulated humoral defect in women experiencing primary infection during pregnancy may be a relative failure of T helper responses rather than of B cells.

There is evidence to show that enhanced humoral immune responsiveness in the fetus correlates with poor prognosis. It has been shown that the cord blood levels of specific IgM, total IgM and rheumatoid factor are positively correlated with symptomatic rather than asymptomatic congenital infection. This effect has been shown to be independent of virus titre at birth and so is not simply secondary to a high virus load in symptomatic infants. Although this suggests that fetal antibody is responsible for immunopathology, it could equally well be that there is another response of the fetus which is damaging and which happens to correlate with the humoral immune response.

The beneficial or adverse effects of humoral immunity could be discerned better if reactivity against a particular virus-coded protein could be shown to correlate with a good or bad prognosis. Many CMV proteins are recognized by the humoral immune system (Landini, 1992), and work to date has not been able to identify such a pattern in congenitally and perinatally infected infants. The ability of serial sera to immunoprecipitate radiolabelled virus-coded proteins has simply shown that symptomatic infants are more likely to

have reacted to multiple virus proteins and that their sera will precipitate more of any given virus protein than will asymptomatic infants. These results are therefore compatible with heightened immune responsiveness leading to disease production.

Cell-Mediated Immunity

For studies of cell-mediated immunity (CMI), the lymphocyte blastogenic response to CMV antigen has been used. This test measures only the recognition, not the effector function, of T lymphocytes but has the practical advantage over other techniques of not requiring syngeneic target cells.

Most, but not all, seropositive adults have a positive test result, whereas few congenitally or perinatally infected infants can respond. This failure recovers with time and there is a direct correlation between cessation of viruria and acquisition of immune responsiveness at 3–5 years of age (Pass *et al.*, 1983).

This defect is known not to be one of generalized T cell immunosuppression, for three reasons. First, CMV-infected infants who also acquire HSV infections generally mount good responses against HSV but not against CMV. Second, these infants respond normally to both killed and live vaccines. Third, the suppressor (CD4) and helper (CD8) T cell lymphocyte subsets remain entirely normal. The precise defect in such children is not known but it is tempting to speculate teleologically that CMV has learned to specifically suppress the function of the cell designed to respond against it. Recent work, summarized in Figure 2C.7 (*see* Plate II), has identified complex but plausible mechanisms, which, in combination, allow the CMV-infected cell to evade lysis by T cytotoxic and natural killer (NK) cells (reviewed in Riddell and Greenberg, 1997). Immediately after uncoating, the tegument protein ppUL83 (pp65) is available in the cell to phosphorylate the IE72 isoform of the major immediate-early protein and so prevent its presentation as a target epitope. At immediate-early times, pUS3 retains class I HLA molecules within the endoplasmic reticulum (ER). Once the virus-infected cell has moved into the early phase of CMV gene expression, pUS2 and pUS11 act to re-export class I HLA molecules back from the lumen of the ER into the cytoplasm, where they are degraded in the proteasome. At both early and late times, pUS6 blocks the activity of the transporter associated with antigen presentation so that

epitopes derived from CMV proteins cannot be presented as targets. All of these functions might, in combination, decrease surface HLA display to such an extent that the cell becomes a target for NK cells which recognize the absence of these normally ubiquitous molecules. To prevent this, CMV encodes another protein, pUL18, which is structurally strongly homologous to class I HLA molecules and acts as a decoy to prevent NK cells attacking the CMV-infected cells.

From the above description, it will be apparent that CMV has evolved a series of genes—coloured dark green in Figure 2C.4 (Plate I)—which act in a coordinated way to abrogate cell-mediated immune responses specific for the virus. Thus, many responses may be initiated but be unable to detect their cellular targets during the initial round of replication. However, when the virus leaves the first cell to initiate infection in a second cell, it is vulnerable to display of protein-epitopes before down-regulation of HLA can be effected in that cell. Accordingly, the dominant effector CMI is directed against ppUL83 (pp65), revealed when the input virion is uncoated (reviewed in Riddell and Greenberg, 1997).

Possible Interactions with HIV

The multiple mechanisms by which HIV may interact with herpesviruses are reviewed elsewhere (Griffiths, 1998). Many studies have shown *in vitro* that CMV infection (or transfection of particular genes) can transactivate HIV (reviewed in Ghazal and Nelson, 1993). Under some circumstances, CMV can also downregulate HIV replication. Overall, CMV is more likely to stimulate HIV when the latter has an integrated provirus and when CMV is not actively replicating (Moreno *et al.*, 1997).

All of the postulated mechanisms of interaction would require close contact between HIV and CMV, either in the same cell or in neighbouring cells. Studies of human tissues have shown that CMV and HIV frequently coinfect the same tissues and that individual cells can be found infected with both viruses.

Epidemiological studies report that the presence of active CMV infection or high quantities of CMV are associated with more rapid progression of HIV infection to AIDS or AIDS to death. It is therefore

possible that CMV (and other herpesviruses) may act as cofactors to accelerate HIV disease but this hypothesis remains unfashionable and the reader is referred elsewhere for more details (Griffiths, 1998).

CLINICAL FEATURES

Congenital Infection

Seven per cent of congenitally infected babies are born with symptoms. They are said to have 'cytomegalic inclusion disease' and their prognosis is poor. The remaining 93% appear to be normal at birth but a proportion develop sequelae on follow-up (Stagno, 1990).

Those Symptomatic at Birth

Classic presentation is with intrauterine growth retardation, jaundice, hepatosplenomegaly, thrombocytopenia and encephalitis, with or without microcephaly. It is often difficult, even for experienced paediatricians, to differentiate solely on clinical grounds between the several agents causing chronic intrauterine infection; laboratory tests for CMV, rubella, syphilis and toxoplasmosis are therefore of importance. Most of the pathology outside the central nervous system (CNS) is self-limiting, although severe thrombocytopenic purpura, hepatitis, pneumonitis and myocarditis are occasionally protracted and life threatening. The CNS involvement may present as microcephaly, encephalitis, seizures, apnoea or focal neurological signs. Such congenital malformations as inguinal hernia in males, first branchial arch abnormalities, anophthalmia, Peters' anomaly, diaphragmatic eventration or cerebellar hypoplasia have all been reported. However, these occur sporadically and may be coincidental. There is therefore no evidence that CMV acts as a teratogen to impair normal organogenesis. Most of the clinically apparent sequelae can be attributed to destruction of preformed target organ cells.

In 20% of cases (1% of all those congenitally infected) the damage caused by the virus is so severe that the patient dies during infancy. If a neonate survives, it is almost certain to have serious abnormalities for the rest of his or her life, especially if abnormalities are seen by computerized axial to-

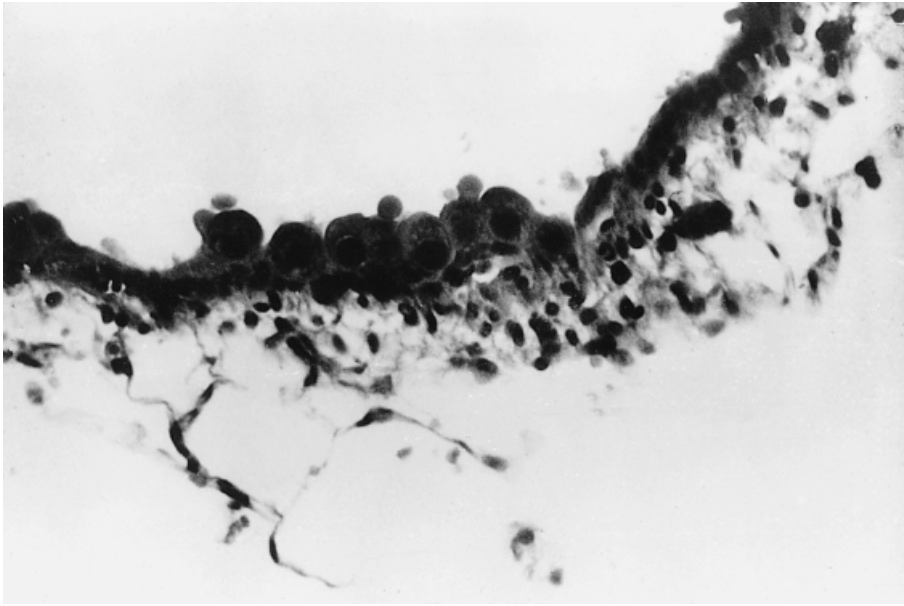

Figure 2C.8 Histological preparation of an inner ear structure from a fatal case of congenital CMV infection showing cell–cell extension of CMV accompanied by an inflammatory response. (Courtesy of Dr S. Stagno, Alabama)

mography (Boppana *et al.*, 1997). On follow-up, clinically apparent extraneural damage rarely persists but brain damage may manifest as microcephaly, mental retardation, spastic diplegia or seizures, and perceptual organ damage as optic atrophy, blindness or deafness. Any of these abnormalities may occur alone or in combination. These defects may appear in children who do not have signs of CNS involvement at birth (including cerebrospinal fluid (CSF) examination). Milder forms of CNS damage, such as defects in perceptual skills, learning disability, minor motor incoordination or emotional lability, may be noticed as the child becomes older.

Those Asymptomatic at Birth

Long-term follow-up of such children has revealed that, compared with uninfected controls, approximately 15% are likely to have hearing defects or impaired intellectual performances. The mean intelligence quotient (IQ) of infected children has been reported to be significantly lower than controls. Other investigators have not noted these defects but their studies have often, although not always, failed to follow children for a sufficiently long time, or have failed to use matched controls. There has been scepticism about the reliability of hearing tests in

young children but there is now sufficient evidence to prove that the hearing loss can occur in a child born with normal hearing. In addition, a plausible pathogenesis for progressive hearing loss is apparent. Figure 2C.8 shows a histological preparation of inner ear structures from a fatal case of congenital CMV infection, demonstrating virus spread by the cell-to-cell route to produce a focus of infection surrounded by inflammation. It is tempting to suggest that this represents the infectious process in the inner ear causing progressive damage to the organ of Corti and decreased ability to perceive sound.

Perinatal Infection

Despite continued excretion of virus for many months, the vast majority of perinatally infected infants do not appear to develop acute symptoms. The initial titres of CMV in the urine are significantly lower than those found in neonates with congenital CMV infection or disease (Stagno *et al.*, 1975), which is compatible with the virus load hypothesis of CMV disease induction. However, occasional cases of infantile pneumonitis have been attributed to perinatal CMV infection. This would appear to be an uncommon event, although CMV is a fre-

quent pathogen in those few infants who do develop pneumonitis in the first three months of life.

Postnatal Infection

Most primary or recurrent infections are asymptomatic. Indeed, most of those identified by prospective serological studies as having seroconversions express surprise when told that they have experienced a virus infection.

Occasionally, however, primary infections are accompanied by the syndrome of infectious mononucleosis. This is similar to the syndrome produced by EBV except that lymphadenopathy is uncommon and the Paul–Bunnell test is invariably negative. The postperfusion syndrome, described earlier, is essentially CMV mononucleosis acquired by blood transfusion. Sometimes, the hepatic component of CMV mononucleosis is prominent, so a diagnosis of non-A, non-B hepatitis is considered initially. Within a few days, however, the full clinical picture becomes clear, with persisting pyrexia and atypical lymphocytosis.

CMV is such a common virus infection that primary infection tends to occur by coincidence with a variety of medical conditions. In addition, since CMV is an opportunist, it will tend to reactivate when a patient becomes debilitated as a result of some underlying condition. If the underlying disease is esoteric and has an unknown aetiology, a case report tends to appear describing the association. By scanning through *Index Medicus*, readers will find literally dozens of such spurious associations, but they should be reassured: CMV is not the cause of all known diseases.

Immunocompromised Patients

Immunocompromised patients may respond to primary or recurrent CMV infections by remaining entirely asymptomatic. More frequently, they will develop a spiking pyrexia which resolves after a few days. Some may develop viraemia with fever and leucopenia, which is sometimes termed 'CMV syndrome'. This may progress to pneumonitis or this complication may supervene directly. In either case, once pneumonitis has become established, the prognosis is poor (mortality 80–90%). Some pa-

Table 2C.6 CMV diseases in the immunocompromised

Symptoms	Solid transplant	Bone marrow transplant	AIDS
Fever/hepatitis	++	+	+
Gastrointestinal	+	+	+
Retinitis	+	+	++
Pneumonitis	+	++	
Immunosuppression	+		
Myelosuppression		++	+
Encephalopathy			+
Polyradiculopathy			+
Addisonian			
Rejection/graft-versus-host disease	+	?	

tients present with virus dissemination to the retina without other signs. Any part of the gut may be the site of CMV replication, which may be asymptomatic or may be associated with ulceration, which can, in extreme circumstances, cause erosion of neighbouring blood vessels with catastrophic haemorrhage. Patients with AIDS may develop a low-grade encephalopathy or polyradiculopathy. At postmortem examination, AIDS patients often have CMV adenitis. Finally, CMV may induce an immunosuppressive syndrome where the patient becomes unable to deal with superinfecting bacteria or fungi. In this instance, and in some of the other clinical presentations (pneumonia, hepatitis, gut ulceration, septicaemia), the underlying nature of the CMV infection is often not recognized by the clinician, who is understandably distracted by the more easily recognized superinfecting organisms.

The major clinical diseases associated with CMV are summarized in Table 2C.6, according to the type of immunocompromised patient. Some diseases, such as gastrointestinal involvement, are found in all patient groups. Some are found in all, but predominate in one group; for example, 85% of CMV disease presents as retinitis in AIDS patients, compared to less than 5% in transplant patients. While this observation remains unexplained, there is extensive evidence to support the hypothesis that CMV pneumonitis in allograft patients is an immunopathological condition caused by an aggressive cell-mediated response against a lung target antigen coded by, or revealed by, CMV infection (Grundy *et al.*, 1987). According to this hypothesis, AIDS patients are relatively spared from pneumonitis because, by the time they are sufficiently immunocompromised to permit CMV dissemina-

tion to the lung, they have insufficient T cell responsiveness to mount the postulated immunopathological response. Likewise, the myelosuppressive CMV disease results when CMV replicates in stromal supporting cells, releasing cytokines and producing a *milieu* unfavourable for haematopoiesis.

These observations relating to different CMV-associated diseases in distinct patient groups, combined with the increasing knowledge about the importance of CMV viraemia and viral load, lead to a potential explanation for the diversity of CMV diseases. CMV viraemia may be a prerequisite for CMV disease at any target site. Increasing viral load may increase the chance that CMV may penetrate tissues to cause disease. Other organ-specific changes, distinct for each patient group, may then dictate in which organ CMV localizes. For example, the marrow suppression is presumably found only after bone marrow transplant because these new cells are receptive to CMV replication.

Several studies have associated CMV with allograft rejection, or graft-versus-host disease in the case of bone marrow transplant recipients. This association could be causal or the immunosuppressive therapy required for treatment of such episodes could allow CMV to reactivate and so be found coincidentally in those with graft rejection. If controlled studies of CMV vaccine or antiviral prophylaxis were able to reduce graft rejection one could conclude that the association is causal; a situation which has been reported in a recent placebo-controlled trial (Lowance *et al.*, 1999).

DIAGNOSIS

As for all viruses infections, there are two potential strategies for providing a diagnosis: the detection of virus or the demonstration of a specific immune response.

Detection of Virus

Collection of Specimens

Urine must be fresh but otherwise can be obtained by midstream collection, by urine bags in neonates or by urinary catheter. Samples can be collected at any time of day and should be sent to the laboratory

without additives, since CMV is stable in urine.

Saliva should be allowed to soak on to a plain cotton-tipped swab, which is then shaken in virus transport medium and broken off.

Heparinized blood samples should be collected with care since heparin inhibits CMV replication and the phenolic preservatives found in proprietary pathology bottles may be toxic to cell cultures. Some 10 ml of peripheral blood should be mixed gently with 500 units of preservative-free heparin. For PCR, acid citrate-dextrose or EDTA is preferred to heparin; check with your local laboratory.

Tissue biopsies should be placed into plain sterile containers with no additives. Fluid and cells obtained by bronchoalveolar lavage should similarly be placed in a plain sterile container.

All specimens should be sent to the laboratory without delay. If delay of more than a few hours is anticipated, then all samples should be sent refrigerated, or on wet ice, but under no circumstances should any specimen be frozen at any temperature.

Selection of Sites for Examination

To diagnose congenital or perinatal infection, urine or saliva samples are usually collected. More invasive procedures such as lumbar puncture or liver biopsy are sometimes performed but identification of CMV at these sites has not been shown to have any prognostic value.

If adults with mononucleosis or hepatitis are being investigated, urine and blood are the best samples. It should be possible to detect CMV from all urine samples collected within a few weeks of onset, while viraemia is often detected in the first few days of illness. The identification of urinary CMV excretion in a patient with such symptoms might be coincidental but the detection of viraemia strongly supports the diagnosis of CMV mononucleosis or hepatitis.

If pregnant women have symptoms, they should be investigated for viraemia. Amniocentesis can be considered after 21 weeks, with the amniotic fluid tested by PCR and culture. However, there is no advantage in actively screening asymptomatic women. Investigations involving the culture of urine, genital secretions, saliva and breast milk have been carried out but the results are not predictive of which women will have babies with congenital or perinatal infection. Since the 'patient' in these examples is the neonate not the woman herself,

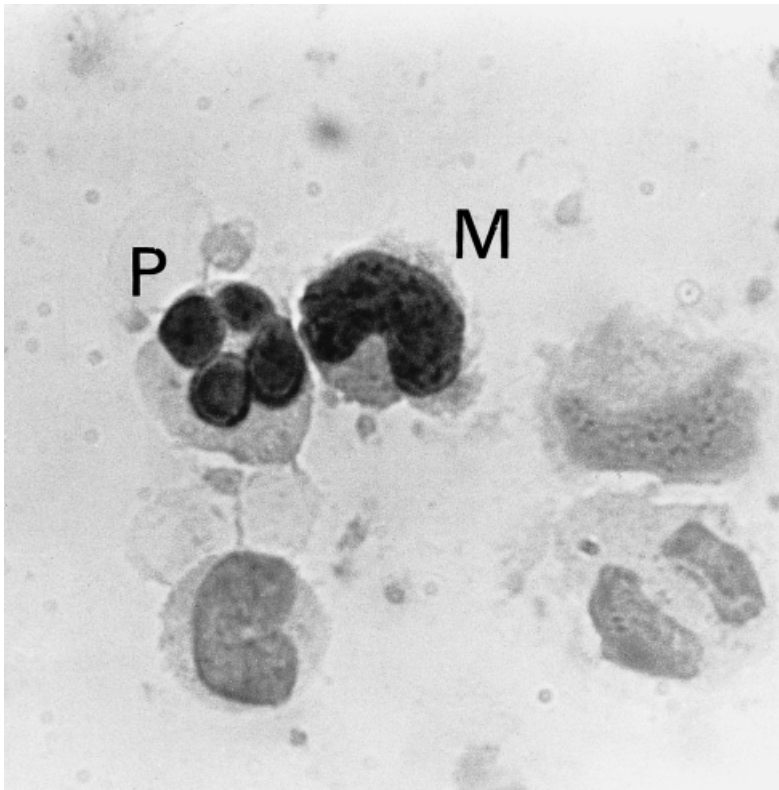

Figure 2C.9 Direct detection of cytomegalovirus in peripheral blood leucocytes. M = Monocyte; P = polymorphonuclear leucocyte (Kindly provided by Professor H. Thé)

samples should not routinely be collected from any maternal site.

Immunocompromised patients should be investigated by means of surveillance samples taken weekly of blood, and possibly urine or saliva in addition. This must be done as a routine on all patients rather than waiting for symptoms to develop. CMV excretion from urine and saliva is very common in allograft recipients so the relative risk for future disease is typically 3. In contrast, PCR viraemia is detected less frequently in allograft patients but, when it does occur, it is indicative of a relatively poor prognosis with a relative risk of about 10. However, even the detection of viraemia does not guarantee that CMV is the cause of, say, the patient's hepatitis or pneumonitis. Ideally, samples should be collected from these target organs whenever possible.

An alternative way of detecting viraemia is through detection of antigenaemia in preparations of peripheral blood mononuclear cells as targets

(van den Berg *et al.*, 1991). These are reacted with monoclonal antibodies against an early protein of *M*, 65 000 (termed *ppUL83*) followed by immunoperoxidase staining (Figure 2C.9). Note that the monoclonal antibody required for this assay does not recognize the immediate-early proteins as originally described. Presumably, the phagocytic activity of the leucocytes shown in Figure 2C.9 has led them to ingest virus-infected material among which *ppUL83* is prominent. It is tempting to speculate that this may derive from dense bodies, since *ppUL83* is a major component of these aberrant forms.

Histopathology

Cytomegalovirus can be recognized in histological preparations by its characteristic 'owl's eye' inclusions. These Cowdry type A intranuclear inclusions have a surrounding halo and marginated chromatin. They can be found in kidney tubules,

bile ducts, lung and liver parenchyma, gut, inner ear and salivary gland but are less prominent in brain tissue (see Figures 2C.8 and 2C.12 for examples).

Although histopathology provides a specific diagnosis, it is known to be insensitive. One study has shown that CMV can be cultured from tissues six times more frequently than typical inclusions can be seen.

Tissue Immunofluorescence

Some biopsy samples (e.g. liver, lung) may contain cells infected with CMV which can be visualized by staining frozen sections with antisera to CMV. Alternatively, the tissue can be disrupted and the cells fixed to glass slides before staining. Bronchoalveolar lavage fluid contains a suspension of cells exfoliated from the respiratory tract, which can be centrifuged, washed to remove adherent mucus and then air-dried and fixed to microscope slides before staining.

Cell Cultures

For conventional cell cultures, human fibroblasts must be used, since they are the only cells which support CMV replication *in vitro*. Foreskins or embryo lungs may be employed as a source of fibroblasts and must be used only at low passage (< 25).

To detect wild strains of CMV reliably, the cultures must be cared for obsessively. The medium must be drained, 0.2 ml of each clinical specimen inoculated and incubated at 37°C for 1 hour to permit virus adsorption. The cultures should then be refed with maintenance medium to reduce the toxic effects of the inoculum. This is especially important in the case of particulate samples such as blood and tissue homogenates. For the detection of viraemia, buffy coat or unseparated heparinized blood can be inoculated into cell cultures. If toxicity is observed, denuded areas of the monolayer can be repaired by the addition of fresh fibroblasts.

All cultures should be observed at least twice weekly for the typical focal cytopathic effect (CPE) of CMV (Figure 2C.10). Occasionally, urine samples from cases of congenital infection produce widespread CPE within 24–28 hours which resembles that of HSV. Usually, however, the CPE evolves only slowly, so the cultures must be maintained for a minimum of 21 days before being reported as negative. This delay in obtaining an

answer has stimulated research into more rapid ways of detecting CMV, which are discussed below.

Electron Microscopy

Samples of urine from infants infected congenitally or perinatally contain high titres (10^3 – 10^6 TCID₅₀ ml⁻¹) of CMV. Using the pseudoreplica electron microscopy technique, it has been possible to demonstrate this viruria. Several authors have reported that approximately 80% of infected infants can be detected, with the false-negative results being clearly attributable to low titre urine samples (< 10^3 TCID₅₀ ml⁻¹). The viral specificity of the technique has been reported at 100%, simply because it would be most unusual for any other herpesvirus to be found at such high titre in urine from infants.

Electron microscopy cannot be used in immunocompromised patients for several reasons. First, the titre of CMV found in clinical samples from adults is generally lower than that found in infants. Second, and more importantly, all human herpesviruses frequently infect immunocompromised patients and cannot be distinguished from each other by electron microscopy. Since different antiviral therapy may be required for each herpesvirus, the results of electron microscopy would not be specific enough to influence patient management.

Detection of Early Antigen Fluorescent Foci (DEAFF)

The technique of DEAFF was developed as a means of retaining the specificity and sensitivity of cell culture without having to wait for the production of CPE as a diagnostic end-point (Griffiths *et al.*, 1984).

Following inoculation on to cell cultures, CMV is absorbed rapidly into the cell. CMV rapidly starts to produce α - and β -proteins but CMV DNA synthesis is delayed and protracted until several days after infection. This explains the long delay seen in conventional cell cultures, since CMV needs to replicate, produce daughter virions and infect neighbouring cells in order to produce the cytopathic effect shown in Figure 2C.10.

To speed up the diagnostic process, cells are inoculated with clinical specimens and stained after only 18 hours incubation using monoclonal antibodies directed against some of the α - and β -proteins

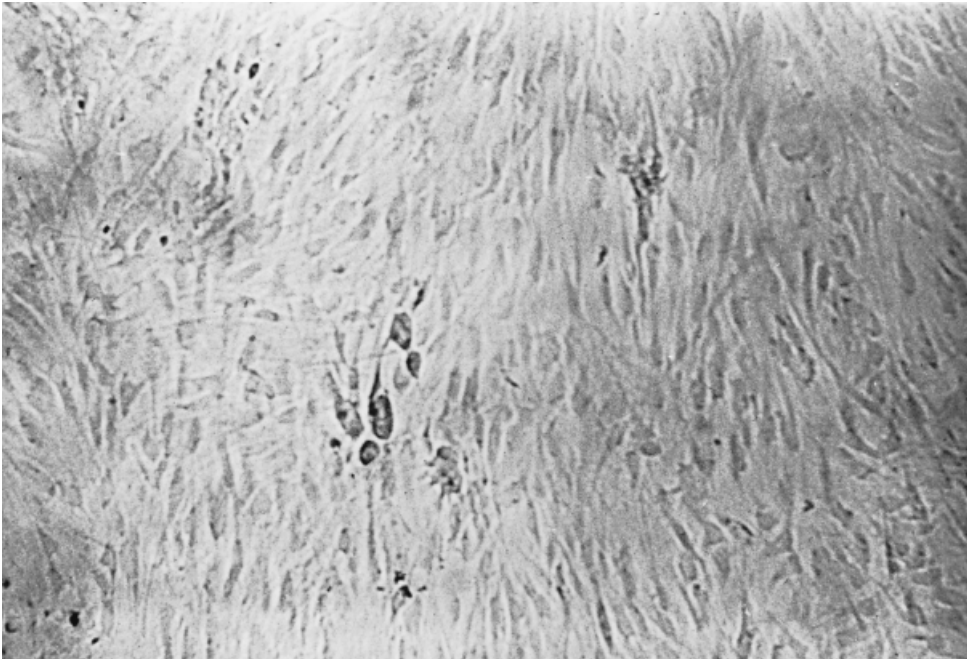

Figure 2C.10 Local cytopathic effect typical of cytomegalovirus seen in monolayer cultures of human embryo lung fibroblasts. (Photograph kindly prepared by Ms A. Grzywacz)

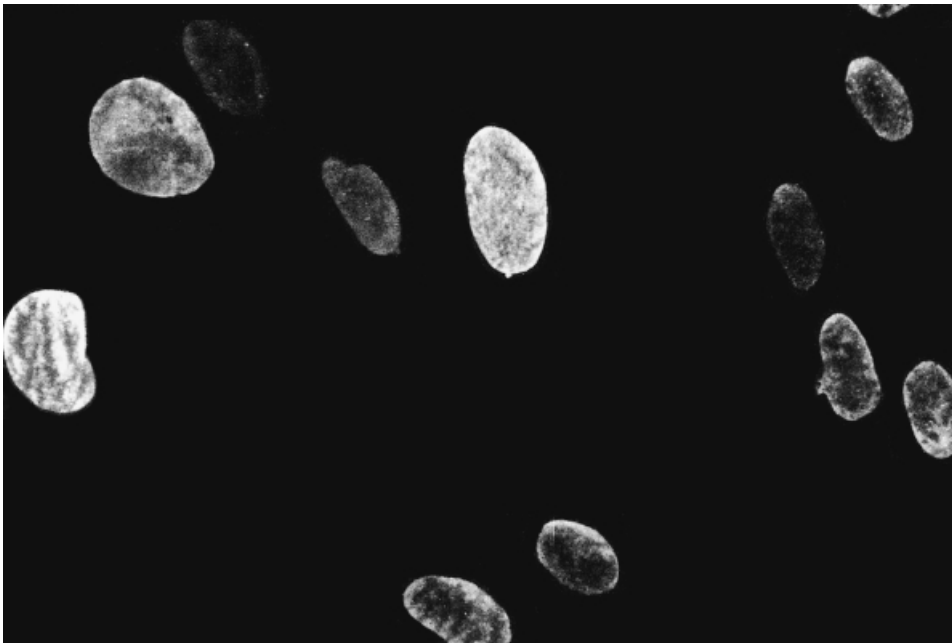

Figure 2C.11 Cytomegalovirus infection diagnosed by detection of early antigen fluorescent foci (DEAFF)

of CMV (Figure 2C.11). This technique is termed shell vial assay in the USA because of the vessels used for the sample processing (Gleaves *et al.*, 1984).

Enzyme Immunoassay (EIA)

The techniques of DEAFF and leucocyte antigen detection provide results rapidly but still require subjective immunostaining and cell culture in the case of DEAFF. The technique of EIA could potentially overcome both of these problems by detecting soluble virus-specific proteins and by producing a colour change, visible to the naked eye, whenever CMV is present.

Some workers established EIA detection systems using polyclonal hyperimmune sera or monoclonal antibodies. The results indicated that EIA could detect small amounts of CMV complement-fixing (CF) antigen or of virus when added artificially to buffer systems. However, when clinical samples containing CMV were assayed, results of low sensitivity and/or specificity were obtained.

Detection of Viral DNA

Earlier reports of the detection of CMV by dot-blot methods have been completely superseded by PCR. Different parts of the CMV genome have been chosen as targets, but there is no obvious advantage in any particular one. Ideally, one would wish to amplify a conserved region, but the degree of genetic variability found in clinical strains is only beginning to be defined (Darlington *et al.*, 1991). Potentially, PCR methods could be so sensitive that they detected low quantities, even latent virus, which would not necessarily be clinically relevant. Indeed, some authors have concluded that their nested PCR procedures do not provide prognostic information. A non-nested procedure was chosen in the author's laboratory to avoid this problem; PCR was found to produce good prognostic information

in both transplant patients (Kidd *et al.*, 1993) and HIV-positive individuals (Bowen *et al.*, 1997). Clearly, 'PCR' is not a single procedure and it is recommended that each laboratory should measure the clinical significance of its results through formal assessment. The availability of fully quantitative PCR assays for CMV (Fox *et al.*, 1992) offers another approach for further refining prognostic values, as well as for understanding pathogenesis, as discussed previously.

Characteristics of the Various Assays Described

These are summarized in Table 2C.7. In previous editions of this book, conventional cell culture was described as the 'gold standard' against which assays should be compared. In 1997, this process can be considered complete for PCR so that it can now be recommended as the new 'gold standard' for providing diagnostic information in a timely manner able to influence the management of individual patients. Any PCR assay which has had a published validation showing correlation with clinical end-points could be employed (Kidd *et al.*, 1993; Einsele *et al.*, 1995; Shinkai and Spector, 1997). Note that the samples required (e.g. whole blood or plasma), the sample extraction and assay-specific details all differ among these validated assays. Colleagues should therefore choose one method and follow the whole procedure exactly as described. Hopefully, commercial assays will facilitate the widespread introduction of PCR, although at present none has been formally evaluated against clinical end-points.

Advantages and Disadvantages of Virus Detection

- The anatomical site of the infection can be documented (e.g. lung involvement in a patient with pneumonitis).

Table 2C.7 CMV detection in body fluids

Method	Sensitivity	Specificity	Reliability	Rapidity	Proven prognostic value
Conventional cell culture	++	+++	++	+	+
Detection of early antigen fluorescent foci	+	+++	++	++	+
Leucocyte antigen detection	++	+++	++	+++	+
Polymerase chain reaction	+++	+++	++	++	+

Table 2C.8 Performance characteristics of several assays used to measure IgG antibodies against CMV

Method	Performance characteristics			
	Sensitivity	Specificity	Objectivity	Rapidity
Neutralization	+	++	+	-
CF	+	+	+	+
IFA-LA	++	-	-	++
ACIF	++	++	+	++
Latex agglutination	++	++	+	+++
RIA	+++	++	++	++
EIA	+++	++	++	++

ACIF = anticomplement immunofluorescence; CF = complement-fixing; EIA = enzyme immunoassay; IFA-LA = immunofluorescence assay for viral late antigens; RIA = radioimmunoassay.

- The patient's immune response is not required for diagnosis, so all infected immunocompromised patients, not just those able to mount an immune response, can be identified.
- Rapid diagnostic methods have enabled infected patients to be recruited into therapeutic trials of potential antiviral agents so that patient management may be influenced.
- PCR methods can quantify the amount of virus in a clinical samples. This should allow quantitative virological assessment of antiviral agents.
- If resistant virus emerges during a course of treatment, this may be detected by the assay and so provide an opportunity for prescription of an alternative drug.
- A potential disadvantage is that the monoclonal antibodies or DNA probes used to detect CMV may be too specific and may identify only some strains of the virus, although this has not as yet proved to be a problem.

Detection of Immune Response

IgG Antibody as a Marker of Past Infection

The detection of IgG antibodies against CMV is indicative of infection sometime in the past. The seropositive individual is liable to experience reactivations of latent infection. The presence of IgG antibodies against CMV is thus a marker of potential infectivity; although a seropositive individual is 'immune' in the immunological sense, this term should not be used to imply protection from endogenous or exogenous infection.

Many CMV IgG assays have been described. Those most frequently used are listed in Table 2C.8 together with estimates of their specificity, sensitivity, objectivity and rapidity. In patients with intact immunity, the CF test is perfectly adequate, provided that a potent antigen is employed and that optimal incubation temperatures are used. Other tests (marked '+ +' in Table 2C.8) are more sensitive in that they produce higher antibody titres but they do not detect substantially more seropositive individuals in a population.

With immunocompromised patients, the CF test often gives false-negative results by failing to detect low levels of IgG antibody. Thus, a more sensitive technique is required and any of those marked '+ +' in Table 2C.8 are satisfactory. If an IF method is chosen, the IFA-LA assay should be avoided because all human sera bind to the IgG Fc receptor induced by CMV and this perinuclear fluorescence can be difficult to distinguish from the virus-specific nuclear fluorescence found with seropositive samples. ACIF is the IF method preferred since it is unaffected by IgG binding to the Fc receptor.

IgG Antibody as a Marker of Acute Infection

Rising levels of IgG antibody were employed in the past but this approach has been completely superseded by assays for detecting virus itself.

Detection of IgM Antibodies

Attempts to detect CMV-specific IgM antibodies

have been plagued by the use of methods of poor sensitivity and specificity and by interference from rheumatoid factor. Testing for IgM antibodies may be helpful in cases of suspected CMV mononucleosis. In all other cases of suspected active CMV replication, investigations using virus detection methods are recommended.

Problems Associated with Serological Diagnosis

- Some immunocompromised patients fail to mount a typical immune response and die from disseminated CMV infection. If diagnoses are made solely by serology, these cases will not be identified.
- The passive transfer of CMV IgG antibodies with blood products may produce 'seroconversions' if sensitive IgG assays are employed.
- The major objection to detecting CMV infection serologically is that the diagnosis is delayed and so can have little effect on the management of an individual patient.

MANAGEMENT

Congenital Infection

The most important part of the management of these cases is to make an unequivocal diagnosis. This is usually accomplished in the case of those symptomatic at birth but is often impossible in those who are initially asymptomatic.

Babies born with symptoms are usually investigated using the appropriate tests; culture of urine or saliva for CMV. The presence of CMV in a neonate aged less than 3 weeks is indicative of congenital infection.

Those born without symptoms are unlikely to have cultures performed and typically present from the age of 6 months onwards with sequelae such as hearing loss or mental retardation. These cases should be cultured for CMV but, if the virus is present, this does not guarantee that the infection was acquired congenitally rather than perinatally. Unfortunately, in each population which has been investigated, perinatal infection is at least ten times more common than congenital infection so that, if

the presence of CMV in a child, say 9 months, is taken as evidence of congenital infection, then such a diagnosis will be wrong in at least 90% of cases. The clinicians may be happy to accept the diagnosis when the clinical findings are reviewed but the child then has only a clinical diagnosis with compatible laboratory findings rather than a definitive virologically-proven diagnosis. Testing for specific IgM antibodies is of no help in this situation since they should be present following congenital infection and will presumably be produced acutely in cases of perinatal infection, although this remains to be investigated.

If CMV is found in a child who develops symptoms during infancy, it is worth bleeding the mother and contacting the laboratory servicing her antenatal clinic to see if sera have been retained. Occasionally, a laboratory has kept a serum used to test for rubella status. If this serum has CMV IgG but not IgM antibodies, then it is unhelpful, since the mother may have had recurrent infection during pregnancy or, if she presented later than 16 weeks, primary infection early in pregnancy. If, however, the serum is IgM positive, it will confirm that she had primary infection during pregnancy, which makes it more likely that her child's CMV was acquired congenitally. Similarly, if the mother seroconverts between early pregnancy and paediatric presentation, this supports a congenital transmission. Finally, the mother may remain seronegative, in which case the child cannot have had intrauterine infection and so the diagnosis of congenital infection can be excluded.

It will be evident from this discussion that the management of these cases would be greatly facilitated if it were possible to screen all newborns for evidence of congenital infection, in a similar fashion to the established phenylketonuria screening programme. At present, cell culture is too cumbersome and expensive a technique to be used widely but it is hoped that one of the modern technologies described earlier will be able to fulfil this role reliably and, of course, cheaply.

Once the diagnosis of congenital infection has been established, an assessment should be made of the prognosis for the child and for a future pregnancy. An estimate of the child's prognosis can be given from the titre of neonatal viraemia and the magnitude of the humoral immune reactivity present in the cord serum, but this can only divide cases crudely into high-, medium- and low risk categories.

More precise prognostic markers are required. The prognosis for a future pregnancy is clear if the diagnosis has been definitely proven and the child was symptomatic at birth; since only one example of cytomegalic inclusion disease has been reported in consecutive siblings, the risk of an identical recurrence must be very low. If, however, the child developed symptoms during infancy, then the position is not so clear. No sibling cases have been reported but this might be because the correct diagnosis has not been made in the past. It remains possible, therefore, that a woman could have a future pregnancy damaged in a similar way. To be scientifically and legally correct, the risk cannot be given as zero but, on humanitarian grounds, the patient may be reassured that the risk must be very low. Before a definitive virological diagnosis is available, the differential diagnosis often includes a recessive gene for presentations with hearing loss, which has a recurrence risk of 25%. If the parents are prepared to gamble with their genes, then the virologist must not dissuade them from taking what must be a far lower risk with CMV.

Having established the diagnosis and prognosis, treatment must be considered, including remedial therapy to compensate for hearing, speech or developmental defects. No specific antiviral chemotherapy is recommended at present, although ganciclovir has been studied in a dose-comparative trial (Whitley *et al.*, 1997). The results show that ganciclovir was relatively well tolerated over the 6 weeks duration of therapy with no excess toxicity from the higher dose of 6 mg kg⁻¹ b.d. As a result, this dose is now being compared against no treatment in a randomized controlled trial. When the results of this trial are published, recommendations about treatment can be made. Until such a time, this author concurs with opinions of the investigators that ganciclovir should not be used outside the setting of a controlled clinical trial (Whitley *et al.*, 1997). The toxicity profile of ganciclovir includes carcinogenesis in rodents and so possible therapeutic advantages must be balanced carefully against potential adverse consequences.

Finally, the parents should be informed about the nature of the child's illness and advised on its infectivity (see below).

Perinatal Infection

These cases produce few medical management difficulties. Most remain asymptomatic and undiagnosed. Cases of infantile pneumonitis should have samples of urine, saliva and nasopharyngeal aspirate cultured for CMV but, apart from bronchoscopy and/or lung biopsy, there is no way of proving that the pneumonitis is due to CMV in an individual case. The main medical importance of perinatal infection is the difficulty it produces for the diagnosis of congenital infection (see above) and the fear of contagion that it stimulates.

It is clear that children less than 18 months of age with perinatal infection can transmit CMV to their parents (Pass *et al.*, 1986). This presumably results from close contact with infected saliva during normal family life and so would be difficult to control completely. Control should be considered, however, if the mother is contemplating pregnancy, although care must be taken not to induce feelings of social isolation or rejection in the older sibling. There is no evidence that these children are contagious to adults outside the family but it seems prudent to advise the parents that the infants should avoid intimate contact with women who may be pregnant or with immunocompromised patients. Unfortunately, this advice, when ultimately passed to schoolteachers, can lead to the children being treated as lepers. The teaching staff may have to be reassured strongly to ensure that the children are not treated differently from any others. It usually suffices to emphasize that 10–20% of the children in the classroom are asymptotically excreting CMV as a result of perinatal infection, so that routine hygienic precautions should be used by all staff for all children. The same advice should be given when the child has congenital CMV infection, irrespective of whether or not the virus has induced disease. It would be absurd to ostracize the occasional case of symptomatic congenital infection, knowing that literally hundreds of other children of the same age are excreting similar amounts of the same virus.

Postnatal Infection

Most cases of postnatal infection are asymptomatic and so do not require management. Exceptions are

Table 2C.9 Diagnosis of intrauterine CMV by testing amniotic fluid

Congenital infection?	Virology PCR results positive		
	Culture	PCR	Totals
Yes	8	9	13
No	0	0	13

From Revello *et al.* (1995).

CMV mononucleosis or hepatitis, which may well be treated once a safe orally bioavailable anti-CMV drug becomes available.

When postnatal infection occurs in a pregnant woman, however, the possibility of termination of pregnancy requires consideration. Recurrent maternal infections are invariably asymptomatic and no laboratory test is currently available which can detect which immune women are transmitting the virus *in utero*. For these practical reasons, it is not possible to contemplate therapeutic intervention in these cases, even though some produce childhood damage (Fowler *et al.*, 1992), so discussion must be limited to primary maternal infections.

By analogy with rubella infection during pregnancy, it has been assumed that primary CMV infection will be most severe when it occurs during the first trimester, so therapeutic termination of such pregnancies would be justified if the diagnosis could be made sufficiently early. Studies have shown that asymptomatic primary CMV infection can be reliably diagnosed early in pregnancy by testing for specific IgM antibodies. It has also been clearly shown that the vast majority of women in developed countries present early enough in pregnancy to allow the infection to be detected and for termination of pregnancy to be performed safely. Studies have confirmed the assumption that primary CMV infection is more severe at this stage of pregnancy: so severe that it produces a statistical excess of fetal losses. These results clearly suggest that some pregnancies involving the potentially most severely affected fetuses are terminated naturally so that medical intervention directed towards the survivors may not be as beneficial as has been assumed.

The risk that an individual fetus may survive to be born with cytomegalic inclusion disease following primary maternal infection before 28 weeks gestation is about 4% (Griffiths and Baboonian, 1984; Stagno *et al.*, 1986). These results clearly demon-

strate that, at present, there is no justification for recommending case finding of asymptomatic primary CMV infection by serological screening during pregnancy and no evidence that the offer of surgical termination of pregnancy in such cases would significantly reduce the incidence of disease attributable to congenital CMV infection (Table 2C.10).

More subtle problems of an ethical or medico-legal nature are presented to a practising obstetrician when a woman develops symptoms due to primary CMV infection early in pregnancy. Two separate cases have been reported where mononucleosis was diagnosed at 22 and 18 weeks, respectively, and the pregnancies were surgically terminated. At first, the therapeutic intervention in these cases appears to be justified, since both fetuses showed signs of intrauterine infection. However, a selection bias is present because only successful reports have been published; where other pregnancies have been similarly interrupted, the cases have not been publicized following abortion of uninfected fetuses. Furthermore, the presence of intrauterine infection does not necessarily indicate that clinically evident disease would have presented itself in childhood, since the majority of congenitally infected infants develop normally.

In summary, there is no evidence to suggest that a symptomatic woman is more likely to deliver an affected baby than is an asymptomatic woman; therefore, while the final decision rests with the parents and their obstetrician, the same virological advice should be given to all. Amniocentesis with culture and PCR of the amniotic fluid has been performed in some cases (Table 2C.9). Overall, these results suggest that, after 21 weeks gestation, CMV can be detected in amniotic fluid in most (Revello *et al.*, 1998). Given the need to make the diagnosis rapidly at this late stage of pregnancy, PCR has an advantage over culture, but the parents must be counselled about the possibility of false-negative results. Coupled with the results of ultrasound scanning to assess fetal growth, amniotic fluid testing for CMV may aid detection of some of the potentially most severely damaged cases.

In two published independent cases, female members of paediatric medical or nursing staff requested termination after discovering that they had acquired asymptomatic primary CMV infection during early pregnancy. Serological tests had been performed because they were caring for infants known

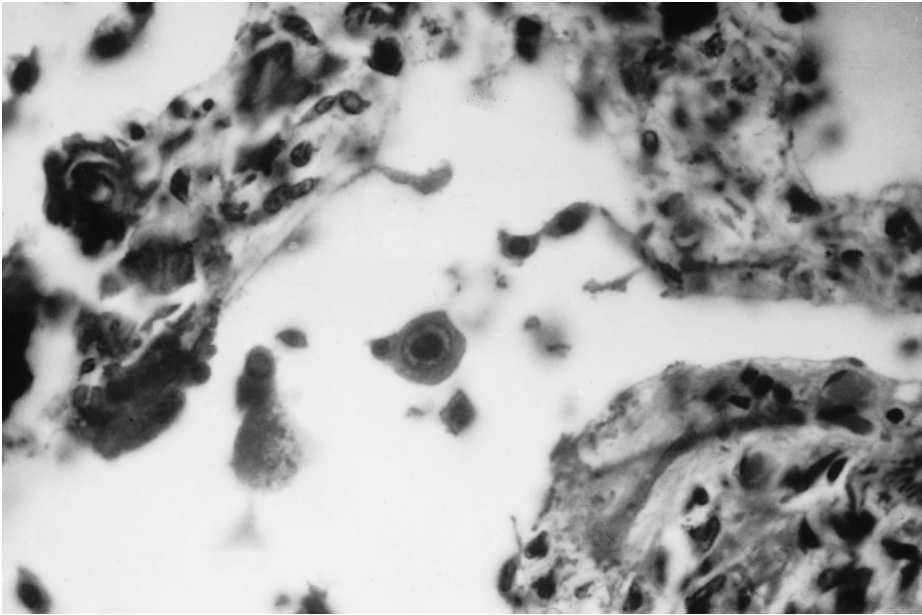

Figure 2C.12 Postmortem histological appearance of cytomegalovirus pneumonitis in a bone marrow allograft recipient. (Reproduced with permission from Griffiths, P.D. (1984) Diagnostic techniques for cytomegalovirus infection. *Clinics in Haematology*, 13, 631–644)

to have congenital CMV infection. Virus isolates were obtained in each instance from the index case, the mother and the aborted fetus. In both cases, the maternal and fetal isolates were shown to be indistinguishable from each other by restriction enzyme analysis but were quite different from their respective index case (Wilfert *et al.*, 1982; Yow *et al.*, 1982). The conclusion is clear: primary CMV infection occurs commonly during pregnancy and will be found if women of childbearing age are investigated. Typing of strains in the published cases showed that the infections were not acquired from recognized occupational exposures, a finding which has important medical implications. There is little evidence that staff exposed professionally to infectious cases have an increased risk of contracting CMV infection but it seems prudent to advise pregnant staff to avoid such contacts if possible by practising good hygienic precautions such as hand-washing after patient contact. This cautious approach is applied to female technical staff working with CMV in the laboratory, although we have never had a case of seroconversion among our predominantly seronegative staff. It should be emphasized that the same advice is given to female staff irrespective of

their serological status; it should be clear that pre-conceptual humoral immunity in these women cannot be equated with a guarantee of protection for the fetus.

Immunocompromised Patients

The most important part of the management of these patients is to make the diagnosis of CMV infection rapidly. Once extensive damage to target tissues has occurred, as is shown in Figure 2C.12, then no antiviral therapy can reasonably be expected to have a successful outcome. To provide advance warning of CMV disease, blood should be collected weekly from all allograft recipients and processed by one of the rapid diagnostic methods, described in the previous section.

If CMV is found in an allograft recipient, then the patient's condition should be reviewed with the clinicians. Many are asymptomatic but some may subsequently become unwell and the availability of rapid virological results may allow the clinicians to reduce immunosuppressive therapy before exten-

sive dissemination of CMV has occurred. The importance of rapid diagnosis in the clinical management cannot be overemphasized, since the differential diagnosis of some illnesses requires an increase in immunosuppressive therapy (e.g. renal allograft rejection episodes). The strategies for the use of antiviral drugs in asymptomatic patients found to have active infection with CMV will be discussed in the next section.

PREVENTION

Is Prevention Needed?

Prevention of an infection can be justified only if it leads to a reduction in ill-health; that is, the infection itself need not necessarily be the target as long as the infectious process can be modified to prevent disease. Potential strategies by which this objective may be accomplished will be detailed, but first it is necessary to consider the magnitude of the problem in the two major populations: congenital and immunocompromised patients.

Congenital Infection

Unfortunately, only estimates of the amount of childhood damage attributable to CMV can be given at the present time since, while it is well recognized that babies symptomatic at birth have a poor prognosis, the full effects on those babies who appear to be normal at birth are only now becoming apparent (Fowler *et al.*, 1992). However, the figures outlined in Table 2C.10 indicate that approximately 400 children per annum suffer overtly as a result of congenital CMV infection in the UK. If these figures are ultimately shown to be correct, then they will confirm congenital CMV infection as the second commonest known cause of mental retardation after Down's syndrome. Prevention of such a relatively common condition would be justifiable if this could be achieved safely and at low cost (Yow and Demmler, 1992).

Immunocompromised Patients

Infections form the commonest single cause of death in allograft patients. In bone marrow recipients, the single most important infection is CMV,

Table 2C.10 Annual public health impact of congenital CMV

	USA	UK
Number of live births	4 000 000	700 000
Proportion congenitally infected	1%	0.3%
Number congenitally infected	40 000	2 100
Number with cytomegalic inclusion disease (7%)	2 800	147
Number fatal (12%)	336	18
Number with sequelae (90%)	2 218	132
Number asymptomatic (93%)	37 200	1 953
Number with sequelae (15%)	5 580	293
Total number damaged	8 134	443

After Stagno (1990).

responsible for approximately 15% of mortality before antiviral treatment became available. In recipients of solid organ transplants, several investigators report this virus to be a major cause of morbidity and mortality. It is not possible to give precise cost-benefit data at present, but if the expense of extra days spent in hospital is taken into account, then prevention of CMV disease may be shown to be potentially cost-effective. Philosophically, also, it would seem sensible for health services to want to prevent CMV disease, if this can be done at reasonable cost, since its investment in high technology transplantation is wasted if the procedures are effective but the patients die from complications of the treatment.

Prevention of transmission. Knowledge of the potential routes of CMV transmission raises the possibility of prevention by interruption of infection. For example, seronegative renal allograft recipients could be matched to receive only kidneys from seronegative donors. Retrospective analysis by means of life-table survival curves has shown that CMV matching has a greater effect on the survival of cadaver kidney recipients than does matching the same patients for HLA class I status. However, CMV reinfection from the donor kidney has also been shown to cause disease, albeit at a rate lower than that found after primary infection (Grundy *et al.*, 1988). If seronegative kidneys were reserved for seronegative recipients, then more infected kidneys would be given to seropositive recipients and matching for other characteristics such as HLA might be prejudiced. Clearly, a controlled trial

of the potential benefits of matching would be required before it could be justified as a clinical routine. While there is no doubt that matching could reduce morbidity and mortality due to CMV, there is equal concern that even greater morbidity and mortality due to graft rejection could result from a policy of matching for CMV. Put bluntly, patients and their relatives would not thank us for merely substituting one specific cause for another on the death certificate.

Likewise, seronegative recipients of all allografts could receive blood products only from seronegative donors, but infected blood might also lead to reinfection of seropositive recipients. A counsel of perfection would be to give only CMV seronegative blood or blood products to all pregnant women, all neonates or all immunocompromised patients, including those with AIDS. This would represent a major burden for the blood transfusion centres, all of which are hard-pressed to provide their current services without introducing further logistical and administrative problems. Alternatively, in-line filters could be used to remove leucocytes during blood transfusion, since this has been shown to reduce CMV transmission in a special care baby unit (Gilbert *et al.*, 1989).

Transmission could theoretically be reduced in the general population by advising women of child-bearing age to avoid salivary or sexual contact with seropositive consorts, but this clearly would be unpopular.

Pre-exposure immunization. This strategy allows CMV exposure to occur but immunizes the recipients beforehand, in the hope of preventing disease. Two broad types of vaccine can be envisaged: live or non-replicating. The latter is preferred by many since it would lack the potential hazard of oncogenicity. However, its development would require knowledge concerning the nature of the virus proteins responsible for protection and the type of host response which can mediate such protection. Since CMV disease only occurs in the setting of T cell immunodeficiency, it would seem logical to assume that these responses are required for control of CMV disease and so design a vaccine containing T cell epitopes. However, the nature of the epitopes recognized by outbred populations of humans remains to be defined, as do the mechanisms for eliciting such responses efficiently from

non-replicating viral immunogens. It has been suggested that dense bodies might be used as immunogens, since they possess many CMV-specific proteins yet lack infectious DNA; however, the technical problems involved in separating dense bodies from virions seem formidable.

Concern over the possible oncogenicity of CMV vaccines derives from theoretical considerations which are common to all live herpesvirus vaccines. The potential beneficial effects of a CMV vaccine in transplant patients would outweigh any potential adverse effects. The Towne strain of CMV vaccine has been reported to reduce the severity of disease in seronegative recipients given seropositive kidneys (Plotkin *et al.*, 1991). The Towne strain could not prevent reinfection of the recipients with a different strain of CMV but no evidence was found of reactivation of vaccine virus when the patients were immunosuppressed. No excess of malignancies of any kind has been found in the recipients of the vaccine.

Homosexual men are at greater risk of acquiring CMV infection than are heterosexual men and could be considered as candidates for the assessment of the efficacy of CMV vaccines. However, most are already seropositive and so studies would probably have to address the more difficult question of whether vaccination could prevent recurrent infection in this group (immunotherapy).

As both allograft recipients and homosexual men often have impaired immune responses and are heavily exposed to CMV, better results might be expected in the general population who have normal immunity and who usually have only mild exposure to CMV. Recent results of a clinical trial of recombinant gB show that this immunogen can induce neutralizing antibodies in seronegative recipients and boost their titre in seropositive volunteers. Ultimately, trials must be done in women of childbearing age but most reviewers agree that these studies would only be justifiable with a non-replicating vaccine. Although the Towne strain vaccine has not been shown to reactivate, the possibility that reactivations might occur during pregnancy with transmission to the fetus effectively precludes such studies being performed. If a subunit vaccine could protect fetuses by preventing primary infection in seronegative women, then the more difficult assessment of the ability of the vaccine to boost immunity immunotherapeutically in seropositive women, and so protect their fetuses, would have to

Table 2C.11 Strategies for deploying chemotherapy against CMV

Term used	When drug given	Risk of disease	Acceptable toxicity
<i>Prophylaxis</i>	Before active infection	Low	None
<i>Suppression</i>	After peripheral detection	Medium	Low
<i>Pre-emptive therapy</i>	After systemic detection	High	Medium
<i>Treatment</i>	Once disease apparent	Established	High

be made. The number of volunteers required to assess this formally is enormous.

Vaccines could also be employed for immunotherapy in patients receiving allografts. Clearly, there would be little point in attempting to present T cell epitopes at this time because the patients would be receiving drugs such as cyclosporin in order to suppress these responses. However, one could aim to present B cell epitopes with the hope of boosting the humoral immune response to keep the CMV load below that required to cause disease. In the case of bone marrow transplantation, immunization of the donor prior to marrow harvest may potentially lead to adoptive transfer of immunity to the recipient.

Passive T cell immunotherapy has also been evaluated after bone marrow transplantation (reviewed in Riddell and Greenberg, 1997). Donor cells are expanded *in vitro* and passively administered to recipients. The clinical results show that the cells persist in recipients, and a controlled trial to evaluate protective efficacy is currently underway.

TREATMENT

The drugs ganciclovir, foscarnet and cidofovir have been licensed for serious or life-threatening CMV infections in immunocompromised patients. Ganciclovir is phosphorylated by the product of the *UL97* gene of CMV (Sullivan *et al.*, 1992) and then the triphosphate acts to inhibit virion DNA polymerase (*UL54*). Cidofovir is a phosphonate compound which is structurally analogous to a nucleoside monophosphate. It does not require activation by *UL97* but is converted to the diphosphate (structurally analogous to a nucleoside triphosphate) by cellular enzymes, and then inhibits *UL54* (reviewed

in Safrin *et al.*, 1997). Foscarnet is a low molecular weight analogue of the inorganic pyrophosphate product of DNA polymerase activity and so acts at a different site and does not require prior anabolism. All three drugs must be administered by intravenous infusion. Ganciclovir produces neutropenia, which may be dose limiting. In animal toxicology studies, ganciclovir has a cytostatic effect on the testis; the clinical significance of this for humans is unknown. Foscarnet is nephrotoxic, although this effect can be reduced by large volumes of normal saline. Foscarnet also affects ionized calcium levels and produces a fixed drug eruption on the skin of the genital area. Cidofovir is nephrotoxic and it is important that patients are hydrated and receive probenecid to decrease renal concentrations of drug.

Strategies for Deploying Antiviral Drugs

Based on the different stages of pathogenesis shown in Figure 2C.6, four distinct treatment strategies can be envisaged for CMV (Table 2C.11). While these strategies have been evaluated formally in transplant patients, it is disappointing that they have not been applied to the design of studies in AIDS patients. Recent results have, however, indicated that the same basic principles apply also to AIDS patients, so I will discuss the findings under the appropriate headings.

Prophylaxis

This approach is to give a drug active against CMV from the time of transplant, and Table 2C.12 lists the double-blind, randomized, placebo-controlled trials which have been conducted to date of such

Table 2C.12 Double-blind, randomized, placebo-controlled trials of prophylaxis for CMV infection and disease after transplantation

Patient group	Study drug	Dose	Planned duration of therapy (weeks)	No. of patients		Markers of efficacy in whole population				Reference
				Placebo	Drug	Reduced viraemia	Reduced excretion	Reduced disease	Increased survival	
RT _x	IFN	3 × 10 ⁶ U 2/w	6	20	21	Yes	Yes	No	No	Cheeseman <i>et al.</i> (1979)
RT _x	IFN	3 × 10 ⁶ U 3/w 6 w	14	22	20	No	Yes	Yes	No	Hirsch <i>et al.</i> (1983)
		3 × 10 ⁶ U 2/w 8 w								
RT _x	IFN	3 × 10 ⁶ U 3/w 6 w	14	36	32	No	Yes	No	No	Lui <i>et al.</i> (1992)
		3 × 10 ⁶ U 2/w 8 w								
RT _x	ACV	800–3200 mg/d	12	51	53	Yes	Yes	Yes	No	Balfour <i>et al.</i> (1989)
RT _x with rejection	Ig	100 mg/kg	15	16	11	No	No	No	Yes	Metselaar <i>et al.</i> (1989)
LT _x	Ig	150 mg/kg	16	72	69	No	No	Yes	No	Snydman <i>et al.</i> (1993)
LT _x	GCV	1 g t.d.s.	14	154	150	NG	NG	Yes	No	Gane <i>et al.</i> (1997)
HT _x	GCV	5 mg/kg b.d. 14 d 6 mg/kg o.d. 5/7 d until 28 d		73	76	No	Yes	Yes	No	Merigan <i>et al.</i> (1992)
HT _x	GCV	5 mg/kg o.d. 3/7 d 6 (+ rejection) until 42 d plus 14 d if rejection		28	28	NG	Yes	No	NG	Macdonald <i>et al.</i> (1995)
BMT _x	GCV	2.5 mg/kg t.d.s. days –7 to –1 then 6 mg/kg 5 d/w after engraftment	Median 13.5	45	40	No	Yes	No	No	Winston <i>et al.</i> (1993)
BMT _x	GCV	After engraftment	Median 10.9	31	33	No	Yes	Yes	No	Goodrich <i>et al.</i> (1993)
BMT _x	ACV	5 mg/kg b.d. 5 d then o.d. 500 mg/m ² t.d.s. 1 m then 800 mg q.d.s. 6 m or placebo. Third arm 200–400 mg q.d.s. 1 m, then placebo	30	102 ^a	105	Yes	Yes	No	Yes	Prentice <i>et al.</i> (1994)

BMT_x = bone marrow transplant; HT_x = heart transplant; LT_x = liver transplant; RT_x = renal transplant; ACV = acyclovir; GCV = ganciclovir; IFN = interferon- α ; Ig = immunoglobulin; d = day; w = week; m = month; NG = not given.

^a Third arm.

prophylaxis. Ganciclovir, the most potent drug *in vitro*, has been subjected to the rigours of several such trials but the other two licensed drugs, foscarnet and cidofovir, have not. In addition, Table 2C.12 shows that interferon- α , acyclovir and immunoglobulin have also been studied, although many physicians do not associate these therapies with anti-CMV activity.

The results summarized in Table 2C.12 show that ganciclovir has consistently demonstrated activity against CMV infection in all patient groups. It also reduced CMV disease in most groups, with some discrepancies which require discussion. After bone marrow transplant, ganciclovir had a strong trend towards protection, which was significant in one study (Goodrich *et al.*, 1993) but failed to reach statistical significance in a second (Winston *et al.*, 1993). After heart transplant, ganciclovir had a significant effect in seropositive recipients (Merigan *et al.*, 1992) but not primary infections, while the opposite was seen in a second study (Macdonald *et al.*, 1995). Note that ganciclovir prophylaxis after bone marrow transplantation had no significant effect or even a trend in favour of survival; presumably, the drug-induced neutropenia facilitated bacterial and fungal infections to which the patients succumbed (Goodrich *et al.*, 1993; Winston *et al.*, 1993). This illustrates the principle in Table 2C.11 that prophylaxis exposes all patients to the risk of side-effects and so should only be contemplated when a drug has no toxicity. In AIDS patients, a trial of oral ganciclovir, 1 g t.d.s. *versus* placebo, was termed 'prophylaxis' because patients did not have CMV disease at trial entry (Spector *et al.*, 1996). Note that this is not virological prophylaxis as defined in Table 2C.11. Nevertheless, PCR data show that the greatest effect of ganciclovir was seen when it was given prophylactically because the drug had less effect in those who were already PCR-positive at trial entry (Spector *et al.*, 1998).

The results in Table 2C.12 also show that interferon- α and acyclovir each had anti-CMV effects *in vivo*, whereas there was no evidence of anti-CMV activity of immunoglobulin. This suggests that, if immunoglobulin does have clinical benefit against CMV disease, this is provided by interference with secondary phenomena rather than CMV itself. Note that the anti-CMV effect of acyclovir is clinically important; indeed, acyclovir is the only antiviral drug shown to improve survival when used for prophylaxis after bone marrow transplantation,

presumably because the modest antiviral activity of acyclovir is not offset by bone marrow toxicity, as is the case with ganciclovir. A randomized comparison of prophylaxis with acyclovir or ganciclovir after liver transplant (not included in Table 2C.12) shows ganciclovir to be superior in controlling CMV disease (Winston *et al.*, 1995), illustrating that the toxicity of ganciclovir is less prominent if bone marrow is not the organ being transplanted.

Early Treatment of Active Infection

Since allograft recipients are monitored closely to detect active CMV infection at the earliest possibility, trials have been conducted to determine if early intervention with antiviral drugs can provide clinical benefit. There are two main approaches: *suppression*, where the drug is given after CMV has been detected at a peripheral site such as in urine or in saliva; and *pre-emptive therapy*, where CMV is detected systemically, either from blood or the lung sampled by bronchoalveolar lavage. The collection of the latter sample is predicated on the immunopathological nature of CMV pneumonitis (Grundy *et al.*, 1987), so that therapy is directed at early virus replication before disease has become established. Both approaches have produced clinical benefit (Goodrich *et al.*, 1991; Schmidt *et al.*, 1991). In particular, the study of ganciclovir in bone marrow transplants by Goodrich *et al.* (1991) showed this drug was literally life-saving when used in pre-emptive mode, in contrast to its lack of effect on mortality when used prophylactically (Goodrich *et al.*, 1993; Winston *et al.*, 1993). Again, the principles summarized in Table 2C.11 are prescient, showing that the toxicity of drugs for particular organs is as relevant as their antiviral potency.

A 'prophylaxis' trial has been reported (Feinberg *et al.*, 1998) of valaciclovir *versus* doses of acyclovir, shown in two previous randomized, double-blind, placebo-controlled trials to be ineffective against CMV disease. The PCR data at trial entry showed that this drug worked best for pre-emptive therapy (Griffiths *et al.*, 1998). This interpretation has been controversial but is now supported by recent natural history studies from three separate research groups (Bowen *et al.*, 1997; Dodt *et al.*, 1997; Shin-kai *et al.*, 1997) showing that PCR viraemia identifies AIDS patients at high risk of imminent CMV disease (Figure 2C.13).

In AIDS patients, there is clearly a therapeutic

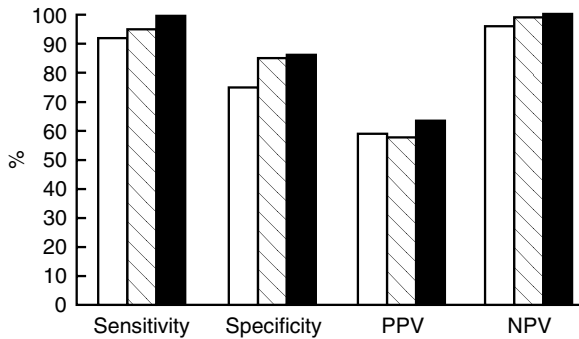

Figure 2C.13 The prognostic value of PCR determined in three separate studies (□, Shinkai *et al.*; ▨, Dodt *et al.*; ■, Bowen *et al.*)

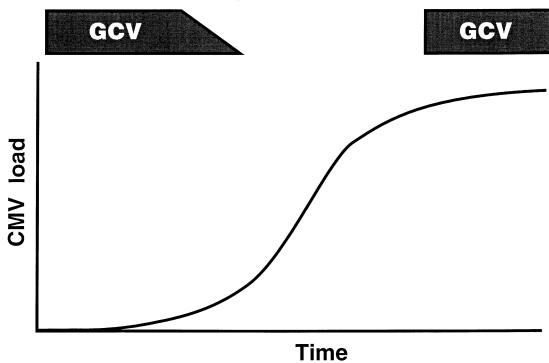

Figure 2C.14 Cartoon showing the ability of different preparations of ganciclovir to deal with varying CMV loads within the blood of AIDS patients. As virus load increases, oral ganciclovir, 1 g t.d.s. runs out of efficacy. When patients present with a high viral load and CMV disease, ganciclovir is effective in reducing virus load but has to be given intravenously

gap for ganciclovir, with no obvious drug available to give pre-emptive therapy at present (Figure 2C.14). At this time, several compounds in development are potential candidates to cover this therapeutic gap, and their current stages of development are listed in Table 2C.14. Note that the dose of valaciclovir chosen in the study described above gave a high incidence of gastrointestinal intolerance so a lower dose must be evaluated. In contrast, higher doses of ganciclovir are being studied to determine if they are sufficiently potent to control CMV viraemia. This may be facilitated by a valine ester prodrug of ganciclovir which delivers the same drug exposure as intravenous ganciclovir.

Treatment of Established Disease

The treatment of an established disease (Table 2C.14) is the most difficult strategy to pursue suc-

Table 2C.13 Current status of drugs for CMV pre-emptive therapy in aids

Drug	Comment
Valaciclovir	2 g q.d.s. poorly tolerated
Oral ganciclovir	3 g/day insufficiently potent 4.5 g/day or 6 g/day?
Valganciclovir	Phase III planned
Adefovir	In Phase III
Lobucavir	Trials stopped
Benzimidivir	In Phase II

cessfully, since the virus may trigger pathological phenomena unresponsive to antiviral drugs and because extensive tissue damage is often followed by target organ failure and secondary opportunistic agents which present their own management problems.

One trial has reported that ganciclovir and foscarnet are equipotent for the treatment of CMV retinitis in AIDS patients, but that foscarnet is associated with a significant survival benefit (Anonymous, 1992). Until this observation is confirmed or refuted, foscarnet is best considered the treatment of choice under these circumstances. However, the difficulties with intravenous administration, toxicity and cost of foscarnet may lead clinicians to prescribe ganciclovir instead. This illustrates that the drugs available at present for the treatment of CMV are far from ideal, so the development of safe, orally bioavailable drugs is eagerly awaited. The management of established CMV retinitis is complex, with multiple therapeutic options including intravitreal injections of antiviral compounds as well as intraocular implantation of a device which slowly releases ganciclovir into the vitreous fluid (reviewed in Jacobson, 1997). These therapeutic options have frequently been evaluated by recruiting patients with peripheral retinitis which is not immediately sight-threatening and randomizing them to immediate therapy *versus* therapy with the same drug, delayed until progression of retinitis has been observed (reviewed in Jacobson, 1997).

Note that CMV lung infection in AIDS patients is not routinely treated because they do not mount the cell-mediated response required for immunopathology (Grundy *et al.*, 1987). CMV pneumonitis in allograft patients is treated with immunoglobulin in addition to ganciclovir because components of the preparation may possibly block

Table 2C.14 Randomized controlled trials of therapy for established CMV disease

Patient group	Organ affected	Drug 1	Drug 2	Planned therapy duration (days)	No. of patients	Significant markers of efficacy reported						Reference
						Drug 1	Drug 2	Reduced viraemia	Reduced excretion	Reduced disease	Reduced dissemination	
BMT _x	Upper GIT	GCV 2.5 mg/kg t.d.s.	Placebo	14	18	19	No	Yes	No	No	No	Reed <i>et al.</i> (1990)
AIDS	Retina	GCV 5 mg/kg b.d. 14 d then o.d.	Foscarnet 60 mg/kg t.d.s. 14 d then 90 mg/kg o.d.	14 induction then maintenance	127	107	ND	ND	No	No	Yes	Anonymous (1992)
AIDS	Lower GIT	GCV 5 mg/kg b.d. 14 d then o.d.	Placebo	14	32	30	No	Yes	No ^a	Yes	No	Dieterich <i>et al.</i> (1993)
AIDS	Retina (relapsed or active retinitis despite maintenance)	GCV 5 mg/kg b.d. 14 d then 10 mg/kg o.d. or foscarnet 90 mg/kg b.d. 14 d then 120 mg/kg o.d.	GCV plus foscarnet: continue existing maintenance dose, add induction dose of second drug for 14 d. For maintenance: GCV 5 mg/kg o.d., foscarnet 90 mg/kg o.d.	Life	183	96	ND	ND	Yes	ND	No	Anonymous (1996)

BMT_x = bone marrow transplant; d = day; GCV = ganciclovir; GIT = gastrointestinal tract; ND = not determined.
^a In intention-to-treat analysis. Yes for subsidiary analysis.

Table 2C.15 CMV in AIDS patients during the era of highly active antiretroviral therapy (HAART): principles learned from transplantation

	Principles from transplantation	Likely effect of HAART
Natural history	CMV infection more common than CMV disease	?
	CMV disease strongly linked to CMV viral load	Better
	Disease uncommon without augmented immunosuppression	Better
	Multiorgan disease \pm secondary phenomena	Worse?
Interventions	Decreased immunosuppression moderates CMV disease	Better
	Response to antivirals: <i>poor once disease established</i> <i>good for pre-emptive therapy</i>	Better?/Worse?
		Better

Better = patients receiving HAART should have improved clinical outcome; worse = HAART may potentially exacerbate CMV disease.

the immunopathological response to target antigens in the lung.

CMV strains resistant to ganciclovir, ganciclovir plus foscarnet, or to ganciclovir plus foscarnet plus cidofovir, have already been described in AIDS patients (Chou *et al.*, 1997). Genetic changes in *UL97* usually confer low-level resistance to ganciclovir. Continued selective pressure may select for *UL54* mutants, some of which are cross-resistant to cidofovir. Rare mutations in *UL54* can confer resistance to both ganciclovir and foscarnet (Chou *et al.*, 1997).

Based on the principles of natural history and pathogenesis gleaned from study of transplant patients, highly active antiretroviral therapy (HAART) should generally improve the long-term control of CMV disease in AIDS patients (Table 2C.15). However, HAART might also alter the clinical presentation of CMV disease, especially where the pathogenetic process includes an immunopathological component. Thus, physicians should be aware of the possibilities of inducing CMV pneumonitis in a patient with asymptomatic CMV lung infection, or producing inflammatory responses to CMV in the liver, gastrointestinal tract or eye. These basic principles reinforce the objective of preventing CMV disease through pre-emptive therapy, rather than trying to treat established diseases.

Summary

Different strategies have been described, with advantages and disadvantages for different groups of patients. For transplant patients, several strategies are available and that which is chosen by a particular unit will depend upon clinical preference and the

laboratory support available. However, such patients should clearly be managed by one of the proactive strategies (*prophylaxis, suppression, pre-emptive therapy*), since it would be unethical to continue to allow the natural history of CMV disease in these patients to proceed unchecked in the face of overwhelming benefit demonstrated in controlled clinical trials. There should be transfer of this concept to AIDS patients so that CMV disease is prevented *via* pre-emptive therapy rather than treated. Indeed, I suggest we set ourselves the objective to regard CMV disease in AIDS patients as a failure of medical management, rather than the starting point of therapeutic intervention.

REFERENCES

- Anonymous (1992) Mortality in patients with the acquired immunodeficiency syndrome treated with either foscarnet or ganciclovir for cytomegalovirus retinitis. Studies of Ocular Complications of AIDS Research Group, in collaboration with the AIDS Clinical Trials Group. *New England Journal of Medicine*, **326**, 213–220.
- Anonymous (1996) Combination foscarnet and ganciclovir therapy vs monotherapy for the treatment of relapsed cytomegalovirus retinitis in patients with AIDS. The Cytomegalovirus Retreatment Trial. The Studies of Ocular Complications of AIDS Research Group in Collaboration with the AIDS Clinical Trials Group. *Archives of Ophthalmology*, **114**, 23–33.
- Balfour, H.H.J., Chace, B.A., Stapleton, J.T. *et al.* (1989) A randomized, placebo-controlled trial of oral acyclovir for the prevention of cytomegalovirus disease in recipients of renal allografts. *New England Journal of Medicine*, **320**, 1381–1387.
- Basgoz, N., Qadri, I., Navarro, D. *et al.* (1992) The amino terminus of human cytomegalovirus glycoprotein B contains epitopes that vary among strains. *Journal of General Virology*, **73**, 983–988.
- Basgar, J.F., Smith, P.P., Ciment, G.S. *et al.* (1996) Developmen-

- tal analysis of the cytomegalovirus enhancer in transgenic animals. *Journal of Virology*, **70**, 3215–3226.
- Boppana, S.B. and Britt, W.J. (1995) Antiviral antibody responses and intrauterine transmission after primary maternal cytomegalovirus infection. *Journal of Infectious Diseases*, **171**, 1115–1121.
- Boppana, S.B., Fowler, K.B., Vaid, Y. *et al.* (1997) Neuroradiographic findings in the newborn period and long-term outcome in children with symptomatic congenital cytomegalovirus infection. *Pediatrics*, **99**, 409–414.
- Bowen, E.F., Sabin, C.A., Wilson, P. *et al.* (1997) Cytomegalovirus (CMV) viraemia detected by polymerase chain reaction identifies a group of HIV-positive patients at high risk of CMV disease. *AIDS*, **11**, 889–893.
- Bowen, F., Wilson, P., Cope, A. *et al.* (1996) Cytomegalovirus retinitis in AIDS patients: influence of cytomegalovirus load on response to ganciclovir, time to recurrence and survival. *AIDS*, **10**, 1515–1520.
- Britt, W.J., Vugler, L., Butfiloski, E.J. *et al.* (1990) Cell surface expression of human cytomegalovirus (HCMV) gp55–116 (gB): use of HCMV-recombinant vaccinia virus-infected cells in analysis of the human neutralizing antibody response. *Journal of Virology*, **64**, 1079–1085.
- Burton, G.J. and Watson, A.L. (1997) The structure of the human placenta: implications for initiating and defending against virus infections. *Reviews in Medical Virology*, **7**, 219–228.
- Cha, T.A., Tom, E., Kemble, G.W. *et al.* (1996) Human cytomegalovirus clinical isolates carry at least 19 genes not found in laboratory strains. *Journal of Virology*, **70**, 78–83.
- Chee, M.S., Bankier, A.T., Beck, S. *et al.* (1990) Analysis of the protein-coding content of the sequence of human cytomegalovirus strain AD169. *Current Topics in Microbiology and Immunology*, **154**, 125–169.
- Cheeseman, S.H., Rubin, R.H., Stewart, J.A. *et al.* (1979) Controlled clinical trial of prophylactic human-leukocyte interferon in renal transplantation. Effects on cytomegalovirus and herpes simplex virus infections. *New England Journal of Medicine*, **300**, 1345–1349.
- Chou, S., Marousek, G., Guentzel, S. *et al.* (1997) Evolution of mutations conferring multidrug resistance during prophylaxis and therapy for cytomegalovirus disease. *Journal of Infectious Diseases*, **176**, 786–789.
- Cope, A.V., Sabin, C., Burroughs, A. *et al.* (1997a) Interrelationships among quantity of human cytomegalovirus (HCMV) DNA in blood, donor–recipient serostatus, and administration of methylprednisolone as risk factors for HCMV disease following liver transplantation. *Journal of Infectious Diseases*, **176**, 1484–1490.
- Cope, A.V., Sweny, P., Sabin, C. *et al.* (1997b) Quantity of cytomegalovirus viraemia is a major risk factor for cytomegalovirus disease after renal transplantation. *Journal of Medical Virology*, **52**, 200–205.
- Darlington, J., Super, M., Patel, K. *et al.* (1991) Use of the polymerase chain reaction to analyse sequence variation within a major neutralizing epitope of glycoprotein B (gp58) in clinical isolates of human cytomegalovirus. *Journal of General Virology*, **72**, 1985–1989.
- Dieterich, D.T., Kotler, D.P., Busch, D.F. *et al.* (1993) Ganciclovir treatment of cytomegalovirus colitis in AIDS: a randomized, double-blind, placebo-controlled multicenter study. *Journal of Infectious Diseases*, **167**, 278–282.
- Dotz, K.K., Jacobsen, P.H., Hofmann, B. *et al.* (1997) Development of cytomegalovirus (CMV) disease may be predicted in HIV-infected patients by CMV polymerase chain reaction and the antigenemia test. *AIDS*, **11**, F21–28.
- Einsele, H., Ehninger, G., Hebart, H. *et al.* (1995) Polymerase chain reaction monitoring reduces the incidence of cytomegalovirus disease and the duration and side effects of antiviral therapy after bone marrow transplantation. *Blood*, **86**, 2815–2820.
- Feinberg, J.E., Hurwitz, S., Cooper, D. *et al.* and the ACTG 204/GlaxoWellcome 123–014 International CMV Prophylaxis Study Group (1998) A randomized, double-blind trial of valaciclovir prophylaxis for cytomegalovirus disease in patients with advanced human immunodeficiency virus infection. *Journal of Infectious Diseases*, **177**, 48–56.
- Fowler, K.B., Stagno, S., Pass, R.F. *et al.* (1992) The outcome of congenital cytomegalovirus infection in relation to maternal antibody status. *New England Journal of Medicine*, **326**, 663–667.
- Fox, J.C., Griffiths, P.D. and Emery, V.C. (1992) Quantification of human cytomegalovirus DNA using the polymerase chain reaction. *Journal of General Virology*, **73**, 2405–2408.
- Gane, E., Saliba, F., Valdecasas G.J.C. *et al.* (1997) Randomised trial of efficacy and safety of oral ganciclovir in the prevention of cytomegalovirus disease in liver transplant recipients. *Lancet*, **350**, 1729–1733.
- Ghazal, P. and Nelson, J.A. (1993) Interactions between cytomegalovirus immediate-early proteins and the long terminal repeat of human immunodeficiency virus. *Reviews in Medical Virology*, **3**, 47–56.
- Gilbert, G.L., Hayes, K., Hudson, I.L. *et al.* (1989) Prevention of transfusion-acquired cytomegalovirus infection in infants by blood filtration to remove leucocytes. Neonatal Cytomegalovirus Infection Study Group. *Lancet*, **i**, 1228–1231.
- Gleaves, C.A., Smith, T.F., Shuster, E.A. *et al.* (1984) Rapid detection of cytomegalovirus in MRC-5 cells inoculated with urine specimens by using low-speed centrifugation and monoclonal antibody to an early antigen. *Journal of Clinical Microbiology*, **19**, 917–919.
- Goodrich, J.M., Mori, M., Gleaves, C.A. *et al.* (1991) Early treatment with ganciclovir to prevent cytomegalovirus disease after allogeneic bone marrow transplantation. *New England Journal of Medicine*, **325**, 1601–1607.
- Goodrich, J.M., Bowden, R.A., Fisher, L. *et al.* (1993) Ganciclovir prophylaxis to prevent cytomegalovirus disease after allogeneic marrow transplant. *Annals of Internal Medicine*, **118**, 173–178.
- Gor, D., Sabin, C., Prentice, H.G. *et al.* (1998) Longitudinal fluctuations in cytomegalovirus load in bone marrow transplant patients: relationship between peak virus load, donor/recipient serostatus, acute GvHD and CMV disease. *Bone Marrow Transplantation*, **21**, 597–605.
- Gretch, D.R., Kari, B., Rasmussen, L. *et al.* (1988) Identification and characterization of three distinct families of glycoprotein complexes in the envelopes of human cytomegalovirus. *Journal of Virology*, **62**, 875–881.
- Griffiths, P.D. (1998) Studies of viral co-factors for human immunodeficiency virus in vitro and in vivo. *Journal of General Virology*, **79**, 213–220.
- Griffiths, P.D. and Baboonian, C. (1984) A prospective study of

- primary cytomegalovirus infection during pregnancy: final report. *British Journal of Obstetrics and Gynaecology*, **91**, 307–315.
- Griffiths, P.D., Panjwani, D.D., Stirk, P.R. *et al.* (1984) Rapid diagnosis of cytomegalovirus infection in immunocompromised patients by detection of early antigen fluorescent foci. *Lancet*, **ii**, 1242–1245.
- Griffiths, P.D., Feinberg, J. *et al.* The ACTG 204/GlaxoWellcome 123–014 International CMV Prophylaxis Study Group. (1998) The effect of valganciclovir on cytomegalovirus viremia and viruria detected by polymerase chain reaction in patients with advanced human immunodeficiency virus disease. *Journal of Infectious Diseases*, **177**, 57–64.
- Grob, J.P., Grundy, J.E., Prentice, H.G. *et al.* (1987) Immune donors can protect marrow-transplant recipients from severe cytomegalovirus infections. *Lancet*, **i**, 774–776.
- Grundy, J.E., Shanley, J.D. and Griffiths, P.D. (1987) Is cytomegalovirus interstitial pneumonitis in transplant recipients an immunopathological condition? *Lancet*, **ii**, 996–999.
- Grundy, J.E., Lui, S.F., Super, M. *et al.* (1988) Symptomatic cytomegalovirus infection in seropositive kidney recipients: reinfection with donor virus rather than reactivation of recipient virus. *Lancet*, **ii**, 132–135.
- Hirsch, M.S., Schooley, R.T., Cosimi, A.B. *et al.* (1983) Effects of interferon-alpha on cytomegalovirus reactivation syndromes in renal-transplant recipients. *New England Journal of Medicine*, **308**, 1489–1493.
- Huang, E.S., Alford, C.A., Reynolds, D.W. *et al.* (1980) Molecular epidemiology of cytomegalovirus infections in women and their infants. *New England Journal of Medicine*, **303**, 958–962.
- Jacobson, M.A. (1997) Treatment of cytomegalovirus retinitis in patients with the acquired immunodeficiency syndrome. *New England Journal of Medicine*, **337**, 105–114.
- Keller, R., Peitchel, R., Goldman, J.N. *et al.* (1976) An IgG-Fc receptor induced in cytomegalovirus-infected human fibroblasts. *Journal of Immunology*, **116**, 772–777.
- Kerry, J.A., Sehgal, A., Barlow, S.W. *et al.* (1995) Isolation and characterization of a low-abundance splice variant from the human cytomegalovirus major immediate-early gene region. *Journal of Virology*, **69**, 3868–3872.
- Kidd, I.M., Fox, J.C., Pillay, D. *et al.* (1993) Provision of prognostic information in immunocompromised patients by routine application of the polymerase chain reaction for cytomegalovirus. *Transplantation*, **56**, 867–871.
- Kondo, K., Xu, J. and Mocarski, E.S. (1996) Human cytomegalovirus latent gene expression in granulocyte-macrophage progenitors in culture and in seropositive individuals. *Proceedings of the National Academy of Sciences of the USA*, **93**, 11137–11142.
- Landini, M.P. (1992) Antibody responses to human cytomegalovirus proteins. *Reviews in Medical Virology*, **2**, 63–72.
- Lowance, D., Neumayer, H.-H., Legendre, C. *et al.* and on behalf of the International Valganciclovir CMV Prophylaxis Transplantation Study Group (1999) Valganciclovir reduces the incidence of cytomegalovirus disease and acute rejection in renal allograft recipients. *New England Journal of Medicine*, **340**, 1462–1470.
- Lui, S.F., Ali, A.A., Grundy, J.E. *et al.* (1992) Double-blind, placebo-controlled trial of human lymphoblastoid interferon prophylaxis of cytomegalovirus infection in renal transplant recipients. *Nephrology, Dialysis, Transplantation*, **7**, 1230–1237.
- Lukac, D.M., Harel, N.Y., Tanese, N. *et al.* (1997) TAF-like functions of human cytomegalovirus immediate-early proteins. *Journal of Virology*, **71**, 7227–7239.
- Macdonald, P.S., Keogh, A.M., Marshman, D. *et al.* (1995) A double-blind placebo-controlled trial of low-dose ganciclovir to prevent cytomegalovirus disease after heart transplantation. *Journal of Heart and Lung Transplantation*, **14**, 32–38.
- McKeating, J.A., Griffiths, P.D. and Weiss, R.A. (1990) HIV susceptibility conferred to human fibroblasts by cytomegalovirus-induced Fc receptor. *Nature*, **343**, 659–661.
- Merigan, T.C., Renlund, D.G., Keay, S. *et al.* (1992) A controlled trial of ganciclovir to prevent cytomegalovirus disease after heart transplantation. *New England Journal of Medicine*, **326**, 1182–1186.
- Metselaar, H.J., Rothbarth, P.H., Brouwer, R.M. *et al.* (1989) Prevention of cytomegalovirus-related death by passive immunization. A double-blind placebo-controlled study in kidney transplant recipients treated for rejection. *Transplantation*, **48**, 264–266.
- Meyers, J.D., Ljungman, P. and Fisher, L.D. (1990) Cytomegalovirus excretion as a predictor of cytomegalovirus disease after marrow transplantation: importance of cytomegalovirus viremia. *Journal of Infectious Diseases*, **162**, 373–380.
- Moreno, T.N., Fortunato, E.A., Hsia, K. *et al.* (1997) A model system for human cytomegalovirus-mediated modulation of human immunodeficiency virus type 1 long terminal repeat activity in brain cells. *Journal of Virology*, **71**, 3693–3701.
- Ott, D.E. (1997) Cellular proteins in HIV virions. *Reviews in Medical Virology*, **7**, 167–180.
- Pari, G.S., Kacica, M.A. and Anders, D.G. (1993) Open reading frames UL44, IRS1/TRS1, and UL36–38 are required for transient complementation of human cytomegalovirus oriLyt-dependent DNA synthesis. *Journal of Virology*, **67**, 2575–2582.
- Pass, R.F., Stagno, S., Britt, W.J. *et al.* (1983) Specific cell-mediated immunity and the natural history of congenital infection with cytomegalovirus. *Journal of Infectious Diseases*, **148**, 953–961.
- Pass, R.F., Hutto, C., Ricks, R. *et al.* (1986) Increased rate of cytomegalovirus infection among parents of children attending day-care centers. *New England Journal of Medicine*, **314**, 1414–1418.
- Pleskoff, O., Treboute, C., Brelot, A. *et al.* (1997) Identification of a chemokine receptor encoded by human cytomegalovirus as a cofactor for HIV-1 entry. *Science*, **276**, 1874–1878.
- Plotkin, S.A., Starr, S.E., Friedman, H.M. *et al.* (1991) Effect of Towne live virus vaccine on cytomegalovirus disease after renal transplant. A controlled trial. *Annals of Internal Medicine*, **114**, 525–531.
- Prentice, H.G., Gluckman, E., Powles, R.L. *et al.* (1994) Impact of long-term acyclovir on cytomegalovirus infection and survival after allogeneic bone marrow transplantation. European Acyclovir for CMV Prophylaxis Study Group. *Lancet*, **343**, 749–753.
- Reed, E.C., Wolford, J.L., Kopecky, K.J. *et al.* (1990) Ganciclovir for the treatment of cytomegalovirus gastroenteritis in bone marrow transplant patients. A randomized, placebo-controlled trial. *Annals of Internal Medicine*, **112**, 505–510.
- Revello, M.G., Baldanti, F., Furione, M. *et al.* (1995) Polymerase

- chain reaction for prenatal diagnosis of congenital human cytomegalovirus infection. *Journal of Medical Virology*, **47**, 462–466.
- Revello, M.G., Sarasini, A., Zavattoni, M. *et al.* (1998) Improved prenatal diagnosis of a congenital human cytomegalovirus infection by a modified nested polymerase chain reaction. *Journal of Medical Virology*, **56**, 99–103.
- Riddell, S.R. and Greenberg, P.D. (1997) T cell therapy of human CMV and EBV infection in immunocompromised hosts. *Reviews in Medical Virology*, **7**, 181–192.
- Safrin, S., Cherrington, J. and Jaffe, H.S. (1997) Clinical uses of cidofovir. *Reviews in Medical Virology*, **7**, 145–156.
- Schmidt, G.M., Horak, D.A., Niland, J.C. *et al.* (1991) A randomized, controlled trial of prophylactic ganciclovir for cytomegalovirus pulmonary infection in recipients of allogeneic bone marrow transplants; The City of Hope-Stanford-Syntex CMV Study Group. *New England Journal of Medicine*, **324**, 1005–1011.
- Shinkai, M. and Spector, S.A. (1995) Quantitation of human cytomegalovirus (HCMV) DNA in cerebrospinal fluid by competitive PCR in AIDS patients with different HCMV central nervous system diseases. *Scandinavian Journal of Infectious Diseases*, **27**, 559–561.
- Shinkai, M., Bozzette, S.A., Powderly, W. *et al.* (1997) Utility of urine and leukocyte cultures and plasma DNA polymerase chain reaction for identification of AIDS patients at risk for developing human cytomegalovirus disease. *Journal of Infectious Diseases*, **175**, 302–308.
- Snydman, D.R., Werner, B.G., Dougherty, N.N. *et al.* (1993) Cytomegalovirus immune globulin prophylaxis in liver transplantation. A randomized, double-blind, placebo-controlled trial. The Boston Center for Liver Transplantation CMVIG Study Group. *Annals of Internal Medicine*, **119**, 984–991.
- Söderberg-Naucler, C., Fish, K.N. and Nelson, J.A. (1997) Reactivation of latent human cytomegalovirus by allogeneic stimulation of blood cells from healthy donors. *Cell*, **91**, 119–126.
- Spector, S.A., McKinley, G.F., Lalezari, J.P. *et al.* (1996) Oral ganciclovir for the prevention of cytomegalovirus disease in persons with AIDS. Roche Cooperative Oral Ganciclovir Study Group. *New England Journal of Medicine*, **334**, 1491–1497.
- Spector, S.A., Wong, R., Hsia, K. *et al.* (1998). Plasma cytomegalovirus (CMV) DNA load predicts CMV disease and survival in AIDS patients. *Journal of Clinical Investigation*, **101**, 497–502.
- Spiller, O.B., Hanna, S.M., Devine, D.V. *et al.* (1997) Neutralization of cytomegalovirus virions: the role of complement. *Journal of Infectious Diseases*, **176**, 339–347.
- Stagno, S. (1990) Cytomegalovirus. In *Infectious Diseases of the Fetus and Newborn Infant* (eds J.S. Remington and J.O. Klein), pp. 240–281. W.B. Saunders, Philadelphia.
- Stagno, S., Reynolds, D.W., Tsiantos, A. *et al.* (1975) Comparative serial virologic and serologic studies of symptomatic and subclinical congenitally and natively acquired cytomegalovirus infections. *Journal of Infectious Diseases*, **132**, 568–577.
- Stagno, S., Reynolds, D.W., Pass, R.F. *et al.* (1980) Breast milk and the risk of cytomegalovirus infection. *New England Journal of Medicine*, **302**, 1073–1076.
- Stagno, S., Pass, R.F., Cloud, G. *et al.* (1986) Primary cytomegalovirus infection in pregnancy. Incidence, transmission to fetus, and clinical outcome. *JAMA*, **256**, 1904–1908.
- Stenberg, R.M. and Stinski, M.F. (1985) Autoregulation of the human cytomegalovirus major immediate-early gene. *Journal of Virology*, **56**, 676–682.
- Sullivan, V., Talarico, C.L., Stanat, S.C. *et al.* (1992) A protein kinase homologue controls phosphorylation of ganciclovir in human cytomegalovirus-infected cells. *Nature*, **358**, 162–164.
- Urban, M., Klein, M., Britt, W.J. *et al.* (1996) Glycoprotein H of human cytomegalovirus is a major antigen for the neutralizing humoral immune response. *Journal of General Virology*, **77**, 1537–1547.
- van den Berg, A.P., Klompmaker, I.J., Haagsma, E.B. *et al.* (1991) Antigenemia in the diagnosis and monitoring of active cytomegalovirus infection after liver transplantation. *Journal of Infectious Diseases*, **164**, 265–270.
- Wang, J. and Razzaque, A. (1993) Mapping and DNA sequence analysis of the cytomegalovirus transforming domain III (mtrIII). *Virus Research*, **30**, 221–238.
- Wertheim, P., Buurman, C., Geelen, J. *et al.* (1983) Transmission of cytomegalovirus by renal allograft demonstrated by restriction enzyme analysis. *Lancet*, **i**, 980–981.
- Whitley, R.J., Cloud, G., Gruber, W. *et al.* (1997) Ganciclovir treatment of symptomatic congenital cytomegalovirus infection: results of a phase II study. National Institute of Allergy and Infectious Diseases Collaborative Antiviral Study Group. *Journal of Infectious Diseases*, **175**, 1080–1086.
- Wilfert, C.M., Huang, E.S. and Stagno, S. (1982) Restriction endonuclease analysis of cytomegalovirus deoxyribonucleic acid as an epidemiologic tool. *Pediatrics*, **70**, 717–721.
- Winston, D.J., Huang, E.S., Miller, M.J. *et al.* (1985) Molecular epidemiology of cytomegalovirus infections associated with bone marrow transplantation. *Annals of Internal Medicine*, **102**, 16–20.
- Winston, D.J., Ho, W.G., Bartoni, K. *et al.* (1993) Ganciclovir prophylaxis of cytomegalovirus infection and disease in allogeneic bone marrow transplant recipients. Results of a placebo-controlled, double-blind trial. *Annals of Internal Medicine*, **118**, 179–184.
- Winston, D.J., Wirin, D., Shaked, A. *et al.* (1995) Randomised comparison of ganciclovir and high-dose acyclovir for long-term cytomegalovirus prophylaxis in liver-transplant recipients. *Lancet*, **346**, 69–74.
- Wu, J., Jupp, R., Stenberg, R.M. *et al.* (1993) Site-specific inhibition of RNA polymerase II preinitiation complex assembly by human cytomegalovirus IE86 protein. *Journal of Virology*, **67**, 7547–7555.
- Ye, L.B. and Huang, E.S. (1993) In vitro expression of the human cytomegalovirus DNA polymerase gene: effects of sequence alterations on enzyme activity. *Journal of Virology*, **67**, 6339–6347.
- Yow, M.D. and Demmler, G.J. (1992) Congenital cytomegalovirus disease—20 years is long enough. *New England Journal of Medicine*, **326**, 702–703.
- Yow, M.D., Lakeman, A.D., Stagno, S. *et al.* (1982) Use of restriction enzymes to investigate the source of a primary cytomegalovirus infection in a pediatric nurse. *Pediatrics*, **70**, 713–716.
- Yurochko, A.D., Hwang, E.S., Rasmussen, L. *et al.* (1997) The human cytomegalovirus UL55 (gB) and UL75 (gH) glycoprotein ligands initiate the rapid activation of Sp1 and NF-kappaB during infection. *Journal of Virology*, **71**, 5051–5059.

Epstein–Barr Virus

Dorothy H. Crawford

University of Edinburgh, Edinburgh, UK

INTRODUCTION

The discovery of *Epstein–Barr virus* (EBV) in 1964 resulted from the description by Denis Burkitt of a geographically restricted tumour occurring in African children (Burkitt, 1958). The tumour, which characteristically arises in the jaw, is now known to be of lymphocyte origin and is called Burkitt's lymphoma (BL). Burkitt noticed that the geographical distribution of the tumour in Africa corresponded to that of holoendemic malaria, and was determined by the climatic conditions (high temperature and high rainfall) in which the malaria-carrying mosquito can breed. Because of this observation Burkitt suggested that the tumour had an infectious aetiological agent for which the mosquito was the vector. This hypothesis led to electron microscopic studies on fresh tumour biopsy material, but this technique was unrewarding. Later, cell lines were grown in suspension culture from BL tumour material (Epstein and Barr, 1964), and in these cells virus particles were seen (Epstein *et al.*, 1964). Further studies showed this to be a new and distinct member of the herpesvirus group. Thus Burkitt's initial postulate of an infectious agent being involved in the aetiology of the tumour proved to be correct, and, although the mosquito does not play the role of vector for the virus, the association with holoendemic malaria remains an important and constant finding.

Seroepidemiological studies have since shown that the virus is a ubiquitous agent; seropositivity increases with age in all communities studied, so

that over 90% of adults worldwide are seropositive. When carrying out these studies Henle and Henle (1966) made the observation that a member of their staff seroconverted while undergoing an attack of acute infectious mononucleosis (IM). Further studies in collaboration with Yale University on college students proved that EBV is the sole aetiological agent in IM (Niederman *et al.*, 1970).

Seroepidemiological and molecular studies have also pinpointed an association between EBV infection and anaplastic nasopharyngeal carcinoma (NPC) (Old *et al.*, 1966, Wolf *et al.*, 1973), a geographically and genetically restricted tumour which is very common in southern China. However, for this tumour, as for BL, EBV does not act as the sole aetiological agent but is probably one of several necessary cofactors in the evolution of the tumour.

More recently the lymphoproliferative lesions and lymphoma which develop in immunocompromised individuals have been shown to be associated with EBV (Crawford *et al.*, 1980). Recently, an association with nasal T cell lymphoma (Jones *et al.*, 1988), a subset of Hodgkin's lymphoma (Anagnostopoulos *et al.*, 1989) and a minority of carcinomas of the stomach (Imai *et al.*, 1994) has emerged.

THE VIRUS

Structure

EBV is a DNA virus, which is a member of the family *Herpesviridae*, subfamily *Gammaherpes-*

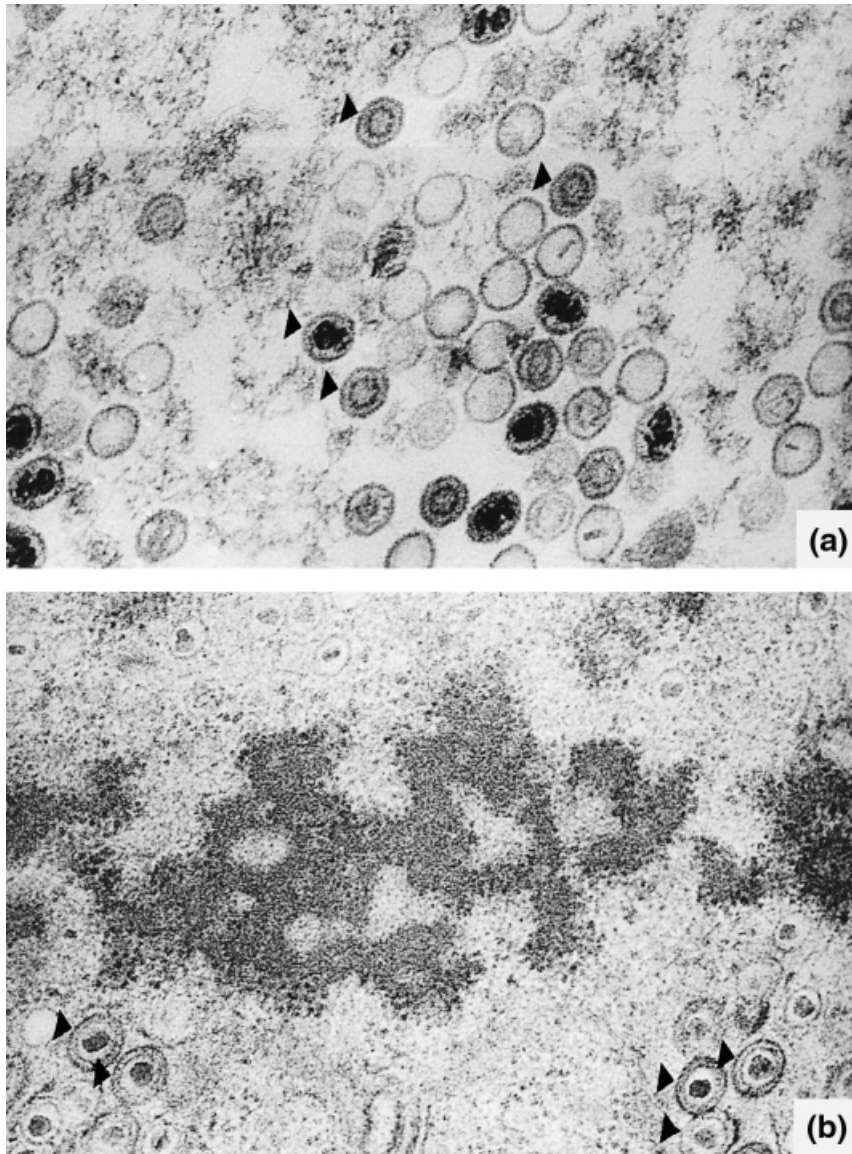

Figure 2D.1 Electron micrographs of the thin section of cells from an EB virus-immortalized lymphoblastoid cell line (M-ABA). Arrows indicate (a) immature virus particles and (b) enveloped virus particles. ($\times 39\,000$)

virinae, genus *Lymphocryptovirus*, showing a structure indistinguishable from other human herpesviruses by electron microscopy. It is a large virus with a buoyant density in caesium chloride of 1.2–1.3 and a molecular weight of 100×10^6 Da. The central nucleic acid of the virion is surrounded by an icosahedral capsid consisting of 162 triangular capsomeres and measuring 100 nm in diameter (Figure 2D.1). This, in turn, is surrounded by an

outer, irregularly shaped, lipid-containing envelope, giving the mature particle a diameter of 150–200 nm. The envelope is derived from cellular membranes of infected cells and is acquired by budding of the immature particles through the cell membrane. The envelope is essential for infectivity, and the sensitivity of the virus to ether and other lipid solvents results from its destruction.

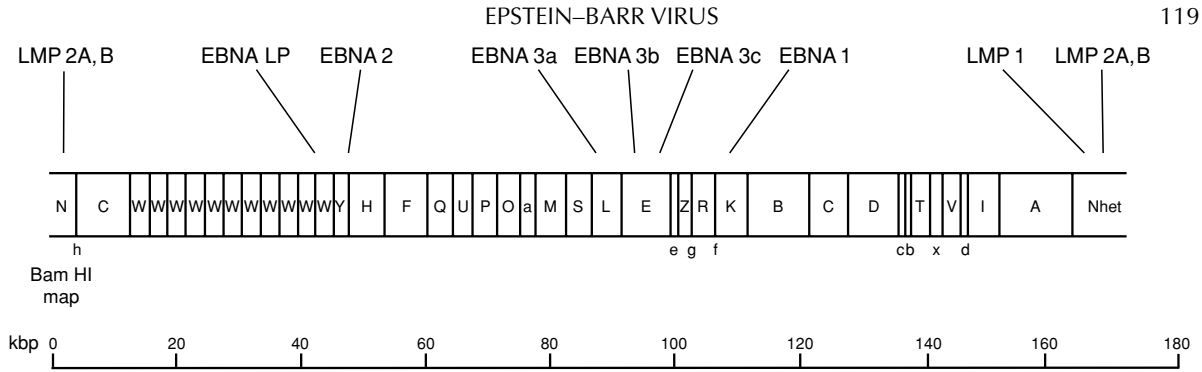

Figure 2D.2 Linear map of the EB virus genome, showing the open reading frames for the major latent proteins

The Viral Genome

The EBV genome is a linear double-stranded DNA molecule of 172 kb in length. Structurally the genome consists of alternating unique and internal tandem repeat regions flanked by terminal repeat (TR) sequences. Restriction maps of the genome have been devised, cloned libraries are available and the whole genome has been sequenced (Figure 2D.2). There are over 90 predicted open reading frames which are designed by a four letter and number acronym; for example, BZLFI refers to the first leftward open reading frame of the Bam H Z fragment of the genome (Baer *et al.*, 1984).

Sequence analysis has defined two strains of EBV—type A and type B (alternatively named 1 and 2)—which differ at the domains that code for the EB viral latent proteins. Although these types show no specific geographical restriction, in Western countries type A viruses are more commonly isolated than type B. *In vitro* type A viruses are more efficient at immortalizing B lymphocytes than type B; however, neither type has a specific disease association. Variation within types occurs in the number of repeat sequences in each internal repeat, making it possible to define specific isolates by the size of their latent gene products.

Following infection of B lymphocytes *in vitro*, EBV establishes a latent type of infection with immortalization of the cell and a restricted (latent) viral gene expression compatible with continued cell proliferation. The viral genome does not usually integrate into cellular DNA but forms a closed circular episome by covalent linkage of the terminal repeat elements. The episome replicates to give multiple copies shortly after infection and thereafter resides in the nucleus and replicates with cellular

DNA, with equal partitioning to daughter cells allowing the copy number per clone to remain constant. These episomal forms can be activated to a lytic infection with the release of multiple viral progeny and cell death (Figure 2D.3).

Viral-coded Proteins

The viral genome is large enough to code for around 100 average-sized proteins, but to date only a small number have been identified and assigned to open reading frames on the viral genome. Nine viral-coded proteins have so far been associated with latently infected cells (Table 2D.1, Figure 2D.2), in addition to the classical herpesvirus immediate-early, early and late proteins associated with the lytic infection. The EBV genome also codes for two small RNA species (EBERS) which form abundant transcripts which are untranslated. Their function is unknown. In addition, a complex series of spliced transcripts from the Bam A region of the genome is found in latently infected cells but no associated proteins have yet been identified.

Latent Proteins

EB viral nuclear antigen complex (EBNA). EBNA was first detected by anticomplementary immunofluorescence in the nuclei of latently infected EBV immortalized B cells (Reedman and Klein, 1973) (Figure 2D.4). It is now known to comprise six proteins (EBNA 1, 2, 3a, 3b, 3c and leader protein (LP); also called EBNA 1–6) which are translated from a long polycistronic mRNA by alternative splicing. Although their functions have not yet been clearly elucidated, EBNA 1, 2, 3a and 3c are re-

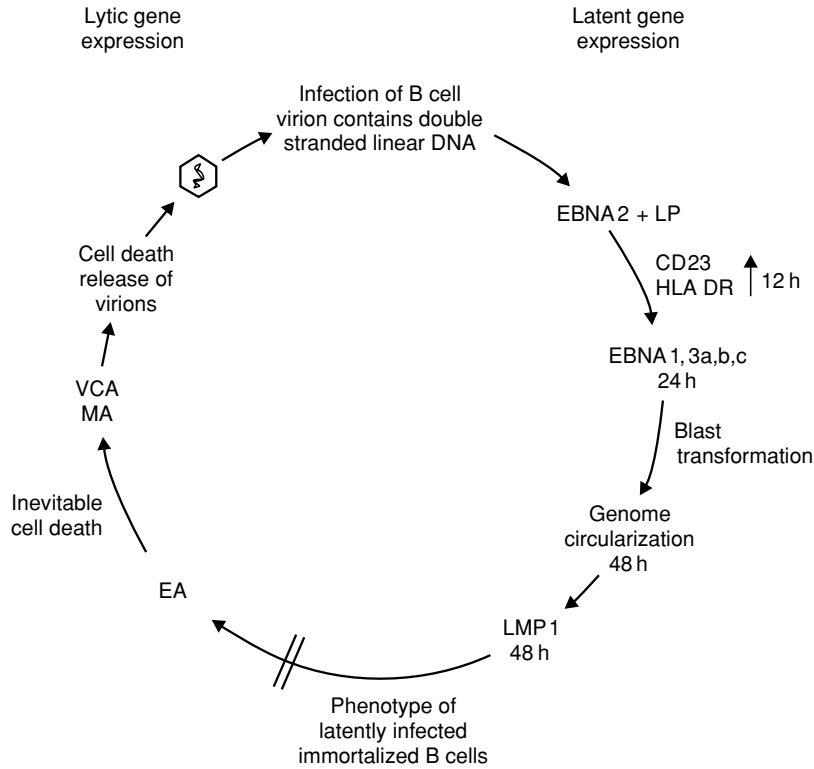

Figure 2D.3 EB virus gene expression and cellular events after infection of a resting B cell. EBNA = EB viral nuclear antigen; LMP = latent membrane protein; EA = early antigens; MA = membrane antigens; VCA = viral capsid antigens

Table 2D.1 EBV-coded latent proteins

Antigen complex	Molecular weight ($\times 10^{-3}$)	Cellular location
EB nuclear antigen (EBNA) 1	65–97	Nucleus
2	75–105	Nucleus
3a	130–195	Nucleus
3b	145–160	Nucleus
LP	20–130	Nucleus
3c	130–195	Nucleus
Latent membrane protein (LMP) 1	58–63	Cell cytoplasm and membrane, virion
2A	54	Cell membrane
2B	40	Cell membrane

EBNA 3a, b, c are also termed EBNA 3, 4 and 6, respectively.
 Leader protein (LP) is also termed EBNA 5.
 LMP 2A and B are also termed terminal protein 1 and 2.

quired for *in vitro* B cell immortalization, whereas EBNA 3b and LP are not (Table 2D.1).

EBNA 1 is coded by the Bam K open reading frame and characterized by a 20–45 kDa glycine-

alanine repeat sequence which varies in length, causing the molecular weight of the protein to vary between viral isolates (65–85 kDa). The protein binds to the viral origin of replication and to metaphase chromosomes, thereby accounting for EBV episomal maintenance within the infected cell and equal partitioning into daughter cells at cell division. EBNA 1 is essential for *in vitro* immortalization of B cells and is expressed in all known virus-carrying cells.

EBNA 2 is an 86 kDa protein which is coded for by the Bam WYH open reading frames. Expression of EBNA 2 is essential for immortalization and the protein is a transactivator of other viral genes (latent membrane proteins 1 and 2) and cellular genes such as the B cell activation antigen CD23 and the oncogene *c-fgr*.

No clear functions have yet been assigned to EBNA 3a, b, c and leader protein, although EBNA 3c is a transcription factor with similar functions to EBNA 2.

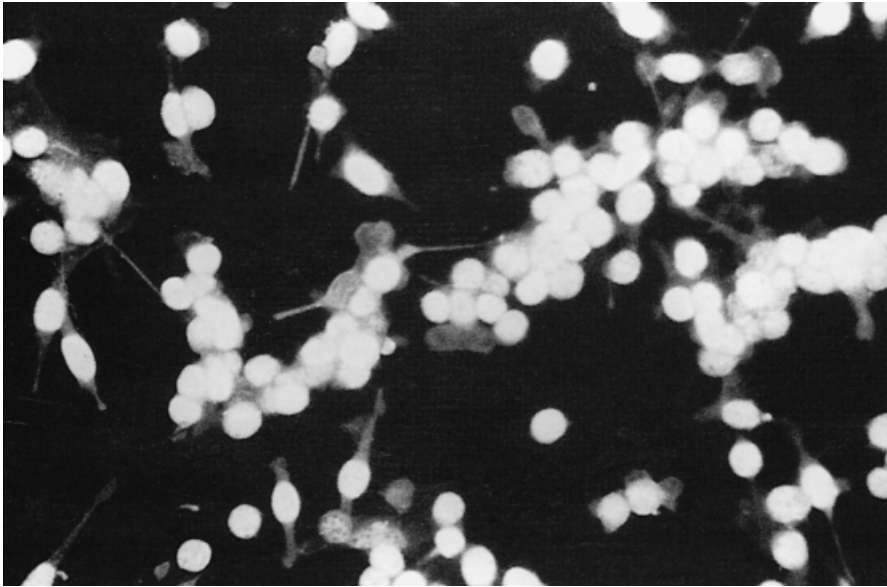

Figure 2D.4 A photomicrograph of cells from an EB virus-immortalized adherent lymphoblastoid cell line (M-ABA) stained for EBNA. Bright nuclear fluorescence is seen in all cells. The cells are counterstained with Evans Blue. ($\times 70$)

Latent membrane proteins (LMP). **LMP 1** is coded for by the BNLF 1 gene, and its expression is induced by EBNA 2. It is the most abundantly transcribed region of the genome in latently infected cells. The protein is found in the viral particle as well as in infected cells, where it has a membrane location with six membrane spanning domains and both the N-terminus and C-terminus in the cytoplasm. LMP 1 is essential for the immortalization of B cells and is a viral oncogene, inducing a tumorigenic phenotype on transfection into NIH 3T3 cells. When transfected in B cell lines, LMP upregulates expression of the cell adhesion molecules and CD21, CD23 and CD40 and induces B cell activation. These changes mimic those seen following CD40-mediated B cell activation, and, in both cases, are mediated by tumour necrosis factor receptor-associated factor (TRAF)-signalling molecules and the transcription factor NF κ B. When transfected into squamous epithelial cell lines, LMP induces the membrane receptor molecules CD40 and the epidermal growth factor (EGF) receptor and inhibits terminal differentiation processes.

LMP 2A and B (also called terminal proteins 1 and 2) are formed by alternative splicing from an open reading frame which spans the terminal repeat sequences, and thus the intact gene is only formed and transcribed after the genome has circularized.

The functions of these proteins are unknown, but they appear to suppress reactivation from latency.

Lytic Cycle Proteins

EBV lytic genes show extensive homology to those of other herpesviruses, and their expression similarly follows an orderly cascade with the expression of each set being activated by the previous, and inhibited by the following set. They are divided into immediate-early, early, and late, according to whether they are transcribed before (immediate-early and early) or after (late) viral DNA synthesis.

Immediate-early genes. EBV possesses two genes that can be classified as immediate-early genes, BZLF1 (Z) and BRLF1 (R), which together transactivate the early genes and thereby effect the switch from latent to lytic infection in B cells.

Early genes. First identified by the staining pattern of sera containing antibodies to EBV when applied to the Raji cell line which lacks expression of the late genes, the early gene products (early antigens, EA) were characterized as diffuse (D) (nuclear and cytoplasmic staining) and restricted (R) (nuclear staining) (Henle *et al.*, 1971). It is now

known that each of these complexes consists of around 30 proteins, most of which have enzyme functions required for viral DNA replication.

Late genes—viral capsid proteins. This antigen complex (VCA) consists of the viral structural proteins that have not yet been analysed in detail because of the lack of a fully lytic system *in vitro*. The major capsid protein p160 is coded for by the BALF4 open reading frame.

VCA is detected by indirect immunofluorescence in a minority of cells in a permissive cell line such as P3HR1 using an EBV-positive human serum.

EBV glycoproteins. The EBV-coded glycoproteins are involved in viral infectivity and spread. Seven have been identified, most of which are inserted into the membranes of the infected cell and three of these become components of the viral envelope (membrane antigens, MA). Two (gp340/220 and gp85) have been studied in detail because they induce the production of neutralizing antibodies and are therefore potential vaccine candidates. Three show extensive homology to herpes simplex glycoproteins.

The major envelope glycoprotein, gp340/220, is coded for by the BLLF1 open reading frame. The protein mediates virus attachment to the B cell surface by binding to the EBV receptor CR2 (also called CD21) (Nemerow *et al.*, 1985). Thus both naturally occurring and experimentally induced antibodies to gp340/220 prevent infection by blocking attachment.

Gp110 is coded for by the BALF4 open reading frame and has homology with the herpes simplex virus glycoprotein gB. It is localized to the nuclear and cytoplasmic membranes of infected cells but is not detected in the viral envelope.

Gp85 is coded for by the BXLF2 open reading frame and has homology to the herpes simplex virus glycoprotein gH. The protein is localized to the plasma membrane and viral envelope, where it induces fusion between the viral and cellular membranes.

Human Homologues

The EBV genome contains homologues of the human interleukin (IL)-10 growth factor and the cell

survival gene *bcl2*, which are thought to be important *in vivo* in immune evasion and viral persistence.

Host Range and Growth *In Vitro*

The host range of EBV is limited to humans, its natural host, and some subhuman primates, including the gibbon, owl monkey, squirrel monkey and some species of tamarin, all of which can be infected experimentally.

In humans, only B lymphocytes are regularly infected by the virus and this restriction of infection is probably accounted for by their expression of CR2 (the receptor for the C3d component of complement, also called CD21), the cell surface receptor used by EBV. A similar molecule found on a subpopulation of squamous epithelial cells may result in infection of these cells in the oropharyngeal cavity, although the extent and role of this infection in normal individuals is a controversial issue. Activated T cells and dendritic cells also express CR2 and may on rare occasions support EBV infection.

In vitro, the outcome of infection of B cells and squamous epithelial cells differs markedly. In epithelial cells a lytic infection occurs with production of new viral progeny and cell death (Sixbey *et al.*, 1984), whereas *in vitro* infection of B cells leads to immortalization (see below).

The only method for demonstrating infectious virus in patient samples is the lymphocyte 'immortalization' test, in which lymphocytes from EBV-negative donors are exposed to the filtered sample and then cultured. The presence of virus in the sample is indicated by the outgrowth of immortalized B cells into a lymphoblastoid cell line (see below). The technique is very time consuming and slow to give results and is therefore not recommended for routine use. Polymerase chain reaction (PCR) detection of EBV DNA is a quicker and more sensitive test but does not necessarily denote infectivity.

EBV Immortalization

When EBV is used to infect B lymphocytes *in vitro*, cell activation occurs within 24 hours (Figure 2D.3). Initially the small resting B cells, which include the susceptible population in peripheral blood, under-

go blastogenesis with an increase in HLA-DR expression, nuclear size and cytoplasmic volume, and the expression of B cell activation antigens on the cell surface. In particular, CD23 expression is reported to be essential for immortalization. After 36 hours DNA synthesis is initiated and cell division takes place at around 72 hours. Around this time immunoglobulin (Ig) can be detected in the cytoplasm of a minority of B cells and it is subsequently secreted into the culture medium; IgM always predominates. This latter finding indicates that EBV is a potent polyclonal activator of immunoglobulin production by B cells. These early changes seen in B cells after infection with EBV are similar to those seen after stimulation with other B cell activators such as the CD40 ligand. However, the polyclonal activation of B-cells by EBV leads to immortalization, which is a permanent rather than a transient event. Thus, once DNA synthesis is initiated, the cells will continue to proliferate in culture as EBV genome-carrying B lymphoblastoid cell lines (LCLs).

Expression of EBNA 2 and LP can be detected by immunofluorescence in a subpopulation of infected B cells as early as 12 hours postinfection and this is followed by the expression of the complete EBNA complex by 24 hours. LMP 1 becomes detectable in these cells around 48 hours postinfection; the kinetics of LMP 2A and B expression is unknown. This viral gene expression (EBNA 1, 2, 3a, b, c, LP; LMP 1, 2A and 2B) is seen in the majority of cells in an LCL and is termed full latent gene expression or latency 3 (Figure 2D.3). Only a minority of cells in an LCL at any one time enter a productive phase resulting in viral progeny and cell death. LCLs derived from different sources show varying degrees of permissiveness for viral replication; thus cell lines made from umbilical cord blood cells are almost non-permissive (less than 1% of cells entering a lytic cycle at any one time), adult derived cell lines contains 2–5% of virus-producing cells, whereas tamarin-derived cell lines are the most permissive, with up to 10–15% of lytically infected cells. B95-8 is a tamarin B cell line infected with IM-derived EBV which is used in most laboratories to obtain infectious virus for experimental purposes by harvesting it from the culture supernatant medium. Most cell lines can be induced by various agents to produce more virus; for example, tetradecanoylphorbol-13-acetate (TPA), sodium butyrate and antibodies to surface immunoglobulin. All these agents induce

maturation of B cells, which is linked to induction of the lytic cycle.

Handling of EBV in the Laboratory

EBV is used as a tool for immortalizing B lymphocytes *in vitro*, and EBV-positive cell lines, most of which produce small quantities of infectious virus, are grown in many laboratories for use in various assay systems. There is therefore general concern about the safety precautions necessary for handling this type of material. In this context it must be remembered that around 90% of the adult population have been infected by the virus and will continue to carry it as a lifelong infection of B lymphocytes and to excrete infectious virus particles into the pharynx. In addition, the virus is of low infectivity, and no authenticated cases of primary infection contracted in the laboratory have been reported. EBV is classified as a hazard group 2 pathogen and therefore EBV-positive cell lines should be handled according to routine microbiological laboratory practice for this group.

EPIDEMIOLOGY

Seroepidemiological studies have been carried out on groups of individuals in the UK, including acute admissions to a paediatric hospital, schoolchildren and teachers, university students and normal healthy adults. The presence or absence of IgG antibodies to VCA has been used to screen these sera, since these antibodies arise early in infection and thereafter persist for life. Results show that seropositivity increases with age, with two peaks of seroconversion occurring at the ages of 1–6 years and 14–20 years (Figure 2D.5). The result is that 80–90% of adults have been infected by EBV. These findings are identical to those from other countries in the Western world. In the developing countries seroconversion occurs early in life, with more than 90% of children over the age of 2 years being seropositive. Most seroconversions occur subclinically, but if primary infection is delayed until adolescence or early adult life acute infectious mononucleosis may result.

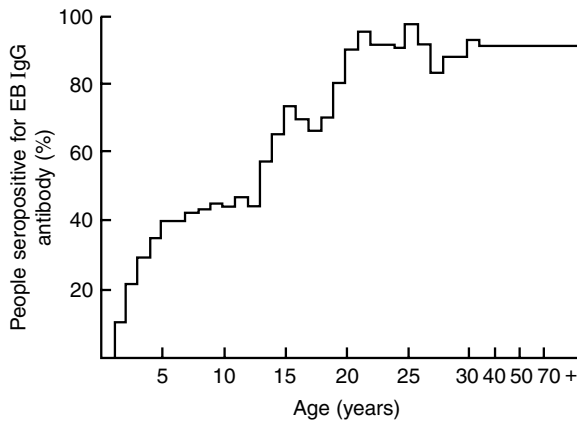

Figure 2D.5 Histogram analysis of IgG anti-VCA antibodies in sera from 1469 individuals. The percentage of seropositivity increases with age to a plateau of 92%

EBV Infection in the Normal Seropositive Individual

In most individuals primary infection occurs subclinically during childhood, and thereafter a lifelong carrier state exists in which a balance is maintained between the level of virus infection and the cellular and humoral immune mechanisms which keep the infection controlled. Continued low-grade virus shedding in the oropharynx can be found in most seropositive individuals by the isolation of immortalizing virus or detection of viral DNA from saliva and throat washings. Furthermore, EBV DNA is present in circulatory B cells, and when large numbers of these are cultured from seropositive individuals 'spontaneously immortalized' EBV positive cell lines may arise, indicating the presence of a few cells capable of producing EBV in the circulation. The origin and longevity of these cells is much disputed; however, most experimental evidence supports the theory that a population of B cells carries the virus in the long term. The suggestion is that these cells are latently infected with a very restricted gene expression, possibly EBNA 1 and LMP 2, and are thereby invisible to immune surveillance mechanisms. Periodic reactivation of this latent infection in epithelial sites, perhaps in association with B cell activation/maturation, would allow lytic infection and egress of the virus from the body. Cells showing more extensive gene expression would be recognized by HLA class 1 restricted, CD8 + cytotoxic T cells, which are present in all

Table 2D.2 EBV-associated disease

Association	Disease
Causative agent	Acute infectious mononucleosis
Aetiologically associated with	Burkitt's lymphoma Nasopharyngeal carcinoma Lymphoproliferative disease and lymphoma in immunosuppressed X-linked lymphoproliferative syndrome Chronic infectious mononucleosis Oral hairy leucoplakia Hodgkin's lymphoma (a subset) T cell lymphoma (a subset) Gastric carcinoma (a subset)

normal seropositive individuals and which recognize all the latent viral gene products with the exception of EBNA 1 (Murray *et al.*, 1992). In this scenario a lifelong balance between the virus infection and immune mechanisms is established which successfully controls the infection in the vast majority of individuals; however, if the balance is altered by intercurrent disease or iatrogenic means which cause a decrease in the specific immune response, EBV-associated disease may occur.

EBV-ASSOCIATED DISEASES

EBV is an unusual virus in that it is associated with several disease states, in some of which it is the direct aetiological agent while in others it acts as an essential cofactor in a complex series of events which lead to the disease. The diseases associated with EBV infection are shown in Table 2D.2. Infectious mononucleosis is the result of primary infection, whereas Burkitt's lymphoma and nasopharyngeal carcinoma occur in seropositive individuals as a result of a series of alterations in a cell type infected by EBV. Oral hairy leucoplakia and lymphoproliferative lesions occur in seropositive individuals in whom immunosuppression has allowed the cell populations naturally harbouring the virus to expand.

EBV is associated with a variety of other diseases, including nasal T cell lymphoma (Jones *et al.*, 1988) and a subset of Hodgkin's lymphoma (Anagnostopoulos *et al.*, 1989), in which the tumour cells

harbour viral DNA and express viral antigens. However, the exact role of the virus in these malignancies is still unclear. Further associations have been described with salivary gland tumours, undifferentiated carcinoma of the stomach, thymomas and leiomyosarcomas.

INFECTIOUS MONONUCLEOSIS

Infectious mononucleosis (IM) is an acute, self-limiting lymphoproliferative disease resulting from primary infection with EBV. It occurs classically in adolescents and young adults in Western societies where a susceptible seronegative population is present in this age group. The clinical disease occurs in about 50% of those undergoing a primary infection with EBV between the ages of 17 and 25 years, whereas the other 50% of individuals of this age group (in common with most individuals before adolescence) become infected and seroconvert without overt clinical illness (University Health Physicians and Public Health Laboratory Service Laboratories, 1971). Since approximately 60% of those reaching the susceptible age for IM in the Western world are already seropositive (Figure 2D.5), classical outbreaks of the disease are uncommon. IM is more common in upper socioeconomic groups and in the Western world because these individuals have been relatively protected from infection during childhood.

Seroepidemiology

Following the original observation of a seroconversion in one individual at the time of an attack of infectious mononucleosis (Henle and Henle, 1966), a large study was undertaken on serial serum samples from students at Yale University (Niederman *et al.*, 1970). The results of this study showed that: (1) no student with antibodies to EBV-associated antigens at entry to university later suffered from IM; (2) no student leaving the university without antibodies had suffered from IM during the years at university; and (3) 50% of those who acquired EBV-specific antibodies during their years at university had clinical IM at the time of seroconversion. The other 50% seroconverted without significant illness. These data confirm the causative role of EBV in IM.

Transmission

Detection of immortalizing EBV in multiple samples of saliva and throat washings indicates that oral excretion of the virus occurs either continuously or intermittently in most seropositive individuals. It is therefore assumed that primary infection occurs by the oral route, by contact with a virus-excreting individual. It is probably this mode of transmission which accounts for the peak age incidence in the 1–6 year age group from family contacts and in late adolescence coinciding with the age at which new social contacts are being made. EBV has also been rescued from the uterine cervix of a few IM patients and normal seropositive individuals and from semen from healthy males. These findings suggest that the virus may be acquired by sexual contact. IM can also be acquired by blood transfusion in seronegative individuals who receive many units of fresh blood.

Pathogenesis

EBV usually enters the body through the mouth, and a productive infection occurs in the oropharynx, from which site infectious virus particles are shed into the oral cavity and can be recovered from saliva and throat washings. It is unclear whether B cells or epithelial cells are the primary cell type infected in the oropharynx, but from this site infected B cells are disseminated throughout the body via the bloodstream, such that early in acute IM infected B cells can be detected in the circulation. These cells express all the latent viral proteins (Tierney *et al.*, 1994) and stimulate both the cellular and humoral arms of the immune response, so that, even before the onset of the clinical symptoms of IM, antibodies to virus-associated antigens and a T cell lymphocytosis are present. The disease is immunopathological in nature, with many of the symptoms being caused by the extremely vigorous T cell response.

Humoral Immunity

The antibody responses to EBV-associated antigens have been extensively studied during primary infection, and they form a pattern characteristic of the disease (Figure 2D.6). Classically, by the time of

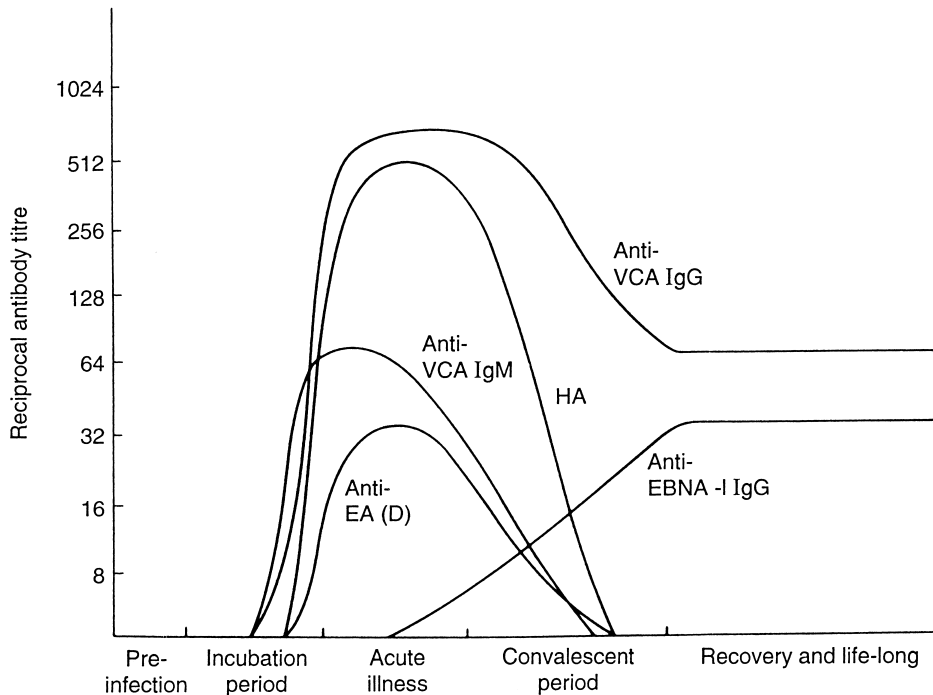

Figure 2D.6 Basic pattern of serum antibodies to EB virus-associated antigens before, during and after primary infection. HA = heterophile antibody; EA(D) = diffuse form of early antigen; other abbreviations as in Figure 2D.3

onset of clinical symptoms, IgM, IgA and IgG antibodies to VCA are present in the serum, as are IgG antibodies to EA (D) and MA. Anti-MA antibodies are neutralizing and probably agglutinate virus particles, thus preventing further infection and spread of the virus. IgM and IgA antibodies to VCA and IgG anti-EA antibodies rise to a peak during the acute disease and decline to undetectable levels during convalescence. IgG antibodies to EBNA 1 are not usually detectable in the serum until the convalescent period, although IgM antibodies to EBNA have been detected transiently during acute IM. Heterophile antibodies regularly appear in the serum early in IM but their relationship to the virus and their role, if any, in controlling infection remain unclear. A variety of autoantibodies may be found in IM, which include cold agglutinins (anti-i), rheumatoid factors, antinuclear antibodies and antibodies to platelets and to smooth muscle. These antibodies, which may account for the raised total serum IgM level found in IM, are thought to be the result of the polyclonal activation of B cells caused by EBV infection. They are usually transient and harmless.

Cellular Immunity

One of the most distinctive features of IM is the presence, at the time of onset of clinical symptoms, of a lymphocytosis and 'atypical' mononuclear cells in the peripheral blood (Figure 2D.7, see Plate II). The rise of lymphocyte count, which may be very marked, is due to a vast increase in absolute numbers of CD8 + T-lymphocytes. This finding is accompanied by depression of T lymphocyte functions, including those measured by *in vivo* delayed-type hypersensitivity testing and *in vitro* mitogen stimulation. The CD8 + T cells have cytotoxic activity against EBV-infected B cells which is mainly MHC class I restricted. A recent study suggests that this represents a response to an EBV-coded superantigen (Sutkowski *et al.*, 1996). These T cells are specific for latent and lytic EBV antigens and probably have an essential role in the complete recovery from IM. Acting together with the humoral elements of the immune response, they control and confine the infection.

Histological Findings

Generally, tissue from IM patients is not available for study, but occasionally liver, bone marrow or lymph node biopsies are performed before the diagnosis is made. Also the histological findings on tissue from surgically removed tonsils or ruptured spleens, and postmortem specimens have been described. In all cases the tissues are infiltrated with mononuclear cells, which are immunoblastic in appearance. In the lymph node the pattern is generally described as 'reactive', with the infiltrate found in widely dilated sinuses and intersinusoidal cords extending into the interfollicular compartment, often obscuring the follicular centres. Occasional Hodgkin or Reed-Sternberg-like cells may be present. In the liver the portal areas are infiltrated and in the spleen the white pulp may be obscured by the extensive infiltrate which extends throughout the parenchyma. Small aggregates of monocytoid cells and immunoblasts can be seen in the bone marrow. Immunological studies showed that the virus-infected B cells are localized in the paracortical region of the lymph node. The histological findings are not diagnostic of IM in themselves, and may be difficult to distinguish from other causes of immunoblastic proliferations, Hodgkin's disease and non-Hodgkin lymphomas.

Clinical Features

Incubation Period

As the source of infection is generally not determined, the incubation period is difficult to calculate; however, a period of 30-50 days is usual before symptoms occur.

Symptoms

Characteristically IM begins abruptly with a sore throat and swelling of the neck, accompanied by non-specific symptoms such as malaise, fever, sweating, chills, headaches, stiff neck, anorexia and vague abdominal discomfort. A prodromal period characterized by lassitude and slight fever is described by some patients. The sore throat, which occurs in 80-90% of patients, is usually mild and clears after 7-14 days. It may, however, be severe

enough to cause extreme pain and difficulty with swallowing, and occasionally gross tonsillar enlargement may lead to pharyngeal obstruction. In 25% of cases secondary infection of the pharynx occurs with a β -haemolytic streptococcus. Less commonly, patients present with jaundice, cough, myalgia or symptoms of one of the neurological complications of IM (see below).

Physical Signs

Lymphadenopathy is present in the majority of cases at some time during the acute illness. The cervical nodes are most obviously involved, but generalized lymphadenopathy occurs, with the nodes often remaining palpable for several weeks. The lymph nodes are discrete and not severely tender. The additional presence of rubbery small lymph nodes in the axilla and groin indicates IM rather than a throat infection with involvement of cervical nodes. Splenic enlargement and tenderness occur in 50-60% of patients, and this is accompanied by mild hepatomegaly in 15-25% of patients. Clinically apparent jaundice occurs in 5-10% of cases. Fevers of 38-40°C are a regular feature during the first 1-2 weeks of IM, with the highest temperature often occurring at midday and being followed by drenching sweats.

Pharyngitis and palatal petechiae occur during the first week of the illness. These may be accompanied by a grey-white membrane which, when associated with pharyngeal oedema and tonsillar enlargement, can result in obstruction to the pharynx of trachea. Periorbital oedema is common early in this disease and may lead to the mistaken diagnosis of nephritis.

Two types of skin rashes can occur: a faint morbilliform eruption which lasts 24-48 hours, or a maculopapular rash which occurs in almost all patients receiving ampicillin. The cause of the latter is unknown, but may be due to the production of antibodies specific for ampicillin and the deposition of immune complexes in the skin arterioles; its presence is regarded by some as diagnostic of IM.

Other associated clinical conditions include encephalitis, meningitis, delirium, coma, psychosis, transverse myelitis, polyneuritis, mononeuritis, pericarditis, myocarditis, interstitial pneumonia and pleural effusions. None of these are common.

IM in Children and the Elderly

When IM occurs outside the classic age range of 17–25 years it tends to present a less typical clinical picture. In children the disease is usually mild and does not require medical attention. Sore throat and cervical lymph node enlargement are usually present but not invariably so. Occasionally children exhibit classic IM even as early as the age of 2 years.

The clinical onset of IM in the elderly is often insidious and occasionally bizarre. The disease can be severe, with hepatic, neurological and renal involvement.

IM in Pregnancy

Infectious mononucleosis during pregnancy is uncommon, but where it has occurred there has rarely been any deleterious effect on the fetus, and termination of pregnancy is not indicated. Lymphoma in babies born to mothers with IM has occasionally been reported but a direct association with EBV infection has been difficult to establish. Rare cases of fatal lymphoproliferative disease in women who developed IM during pregnancy are better documented, and suggest that the immunological changes associated with pregnancy may have inhibited the normal immune control of IM (see above).

IM in the Immunosuppressed

When primary EBV infection occurs in immunocompromised patients, particularly after organ transplantation, it is often asymptomatic due to the patient's inability to mount an immune reaction; however, it may result in atypical disease, with gastrointestinal symptoms and/or signs of renal graft rejection and failure being reported. Antibodies to EB viral antigens may be slow to develop, with neither IgM antibodies to VCA nor the heterophile antibody test being invariably positive. Some of these primary infections progress to lymphoproliferative disease and lymphoma (see below).

Course and Convalescence

The illness may last for several weeks, and even when obvious symptoms have resolved the tem-

perature may continue to rise at midday. The patient often feels exhaustion on the slightest exertion and complains of an inability to concentrate for several weeks after apparent recovery. However, a study carried out on the achievement of students in their examinations after an attack of IM showed no significant change from the expected performance. Occasional patients, particularly those over 25 years of age, may experience intermittent fatigue over the following 2 years. Any contribution they make to the group described as having chronic fatigue syndrome (CFS) can only be ascertained when full documentation of serological tests during the acute and subsequent phases are available (see below). Other patients suffer 'relapses' during the 6 months to 1 year following IM, with return of fever, sore throat and lymphadenopathy accompanied by a positive heterophil antibody test. The exact nature of these relapses is unclear, since the serological markers of primary infection may remain positive for up to a year even in subclinical cases of seroconversion.

Complications

In the vast majority of cases IM is a benign and self-limiting disease from which complete recovery is the rule. However, certain morbid complications have been described in the literature, which account for around 30 deaths per year in the USA. The main causes of death are neurological complications, splenic rupture, hepatic failure and secondary infection. Approximately half the deaths are associated with X-linked lymphoproliferative syndrome (see also page 137).

Neurological Complications

These include meningitis, encephalitis and the Guillain–Barré syndrome. Each of these conditions may precede, accompany or postdate IM by several weeks. Recovery is usual.

Hepatic Complications

Although many IM patients have biochemical evidence of hepatocellular damage, overt jaundice is uncommon (5–10%), and complete recovery is the

rule. However, more severe cases have been reported, and these include massive hepatic necrosis resulting in death.

Splenic Rupture

This is a well-known but rare complication of IM, which may occur spontaneously or after mild trauma. The rupture gives rise to severe abdominal and shoulder pain and requires immediate surgical intervention.

Pharyngeal and Tracheal Obstruction

These may occur due to massive enlargement and oedema of the tonsils, adenoids, uvula and epiglottis, giving rise to an inability to swallow or to stridor with eventual cyanosis. A short course of corticosteroids usually gives a dramatic improvement, but intravenous hydration and feeding or tracheostomy may be necessary as emergency measures.

Chronic IM

Chronic cases of IM where symptoms persist for more than a year occur rarely (around 1 in 2000 cases) and may occasionally result in death from lymphomatous disease. In these cases there is a persistence of the acute IM-like serological profile, usually with grossly elevated titres of IgG antibody to VCA and EA-D, absence of IgG antibody to EBNA 1 and a positive monospot test. An atypical lymphocytosis is also found which is mostly due to CD8 + T cells, and in some cases EBNA + B cells can readily be detected in the circulation. Virus can be isolated from throat washings in high titre, suggesting increased virus replication at this site. These findings are likely to be due to inadequate immunological control of viral replication, and indeed in some cases a lack of EBV-specific memory T cells in the circulation has been demonstrated (Borysiewicz *et al.*, 1986). Chronic IM has been treated with acyclovir and steroids as well as a variety of agents such as interferons, but results are disappointing.

Cases of chronic IM can be distinguished from CFS (Chapter 14) on clinical grounds and by an EB viral antibody screen. When this is performed on CFS patients around 10% have mildly elevated VCA and/or EA antibody titres. In most cases this is likely to be a secondary reactivation event accompanying general immunological abnormalities,

rather than a specific aetiological association between EBV and CFS.

Immunological Complications

These include haemolytic and aplastic anaemia, thrombocytopenia, hypogammaglobulinaemia and agranulocytosis. These disorders may result from excess autoantibody production, such as to the blood group antigen i, due to B cell stimulation, or to abnormal suppression of haemopoiesis by T cells. Fatal EBV-associated haemophagocytosis syndrome has also been described (Kikuta *et al.*, 1993).

Laboratory Findings

The classic finding in IM, after which the disease is named, is the 'atypical' mononuclear cells in the peripheral blood which were first described by Downey and McKinlay (1923) (Figure 2D.7—Plate II). These cells account for the leucocytosis which is regularly seen in the first 2 weeks of IM, with white cell counts of $15-25 \times 10^9$ per litre. Over 50% of these cells are T lymphocytes and usually over 20% of these are 'atypical' or large activated cells. A few atypical mononuclear cells occur in the peripheral blood in other acute virus infections, including cytomegalovirus, hepatitis B, influenza B and rubella, but they are most prominent in IM.

Morphologically, 'atypical' cells are larger than resting lymphocytes (10–20 μm in diameter), and when stained with May-Grünwald-Giemsa stain they show abundant pale blue, vacuolated cytoplasm and an elongated or indented nucleus with coarse nuclear chromatin (Figure 2D.7—Plate II). They express the surface markers typical of activated CD8 + T cells. B lymphocytes are usually present in normal or slightly raised numbers in the circulation in acute IM, and around 1 in 10^4-10^5 are infected with EBV and express all the latent viral proteins.

Abnormal liver function tests indicative of hepatocellular damage are found in the majority of patients. Liver enzymes are usually raised during the second and third week of the illness, and have returned to normal by the fifth week. In 30% of patients the bilirubin level is raised.

Diagnosis

The diagnosis of IM may be suspected on clinical grounds and substantiated by the haematological findings of 'atypical' lymphocytes, but a firm diagnosis of IM relies on the serological demonstration of antibodies to EBV-related antigens. A preillness specimen is rarely available to prove absence of antibody before the illness, and IgG antibodies to VCA are usually present in the first serum sample received, having often already reached their maximum titre. Therefore it is only occasionally possible to demonstrate a diagnostic rise in IgG. High levels of IgG anti-VCA antibodies are not of diagnostic significance, since variable levels are reached during the illness, and higher levels may occur in other diseases. The presence of IgM antibodies to VCA, with or without IgG antibodies to EA (D) and an absence of IgG anti-EBNA 1, are diagnostic. However, these are time-consuming tests carried out most reliably by indirect immunofluorescence, and results from different laboratories are variable. Recently, reliable but less sensitive ELISA tests have become available. False-positive results in the IgM test may result from cross-linking between specific EB viral IgG and anti-IgM conjugate by rheumatoid factor, and, therefore, if this factor is present in the serum, it should be absorbed out with staphylococcal A protein before testing. For these reasons most laboratories rely on the heterophil antibody test, which has been simplified in a kit form as the monospot test.

Heterophil Antibody Test

This test is variously called the Paul-Bunnell test, the Davidsohn-Henry test, or the Lee-Davidsohn test after the authors who described each variation (Davidsohn and Henry, 1969). It detects an IgM heterophil (HA) antibody which causes haemagglutination of red cells from species other than humans. The classic test used a doubling dilution titration of serum and sheep red cells. The use of horse rather than sheep red cells has since been found to increase the sensitivity of the test without loss of specificity. The test was modified to exclude Forssmann antibody by absorption of the serum with guinea-pig kidney emulsion (GPK) before testing. A further refinement to confirm the specificity of the heterophil antibody titre was to compare the titres

with and without absorption with ox cell stroma (OCS), which specifically removes the heterophil antibody of IM. Results are usually expressed as three red cell agglutinin titres: (1) of unabsorbed serum; (2) of serum absorbed with GPK; and (3) of serum absorbed with OCS. A diagnostic criterion commonly used is that the titre of (3) must be at least fourfold lower than the titre of (2), with the titre of (1) being 56 or higher. Very early and late sera may show lower titres. The test may be clearly positive for only a short period of the illness, so repeat tests should be made at intervals if a titre below 56 is encountered.

Monospot test

Slide tests have been developed using absorption combined with agglutination which are quick and reliable. Drops of serum are placed on two squares on a slide; GPK is stirred into one drop and OCS into the other. Horse red cells are added to each square and stirred into the absorbed serum. Agglutination in the GPK square and not in the OCS square is indicative of IM.

The monospot test is positive in around 85% of IM cases (as confirmed by positive anti-VCA IgM). Negative or very weak Paul-Bunnell test or monospot results are more common in sera from children with IM under 14 years than in those from older children or adults. This may be because clinicians avoid taking repeated blood tests from children or because HA may arise due to the polyclonal stimulation of memory B cells. If the priming exposure to the unknown 'heterophil' antigen has not yet occurred in the young subject, no specific memory B cells would be present and no secondary rise could be induced. False-positive HA tests have been extensively recorded, although they are fewer in number since the refinement of absorption was introduced. When testing serial sera from students and nurses to identify the time of primary EBV infection, the first serum to show anti-VCA IgG antibody was often also positive in the HA test and this persisted in serum samples taken up to 6 months later. This regularly occurred when seroconversion was accompanied by clinical IM but also occurred when no recent symptoms were recollected by the individual. A positive HA test has been demonstrated up to 13 months after onset of IM, although the illness was no longer apparent. If some other clinical condition had arisen in these people a 'false'-positive

HA test might have been recorded in association with the new condition. In many tests performed on students and patients from whom sera have been taken for differential diagnosis of IM there has been concordance between the HA tests and the anti-VCA IgM test which indicates current primary infection.

Treatment

This is largely supportive. The sore throat may be extremely painful and regular analgesics are then essential. Some physicians regularly treat cases of IM with corticosteroids, claiming that this curtails the severity and duration of the illness. Others feel that such treatment should be reserved for severe pharyngeal or tracheal obstruction, neurological and haematological complications, since most symptoms are caused by the immune T cell infiltrate in the tissues, and, as this is part of the host defence, it is unwise to diminish it with steroids.

BURKITT'S LYMPHOMA

Burkitt's lymphoma (BL) is a tumour which occurs endemically in equatorial Africa and Papua New Guinea and sporadically worldwide. The African (endemic) form of the tumour is geographically restricted to those areas in which holoendemic malaria occurs (Figure 2D.8). These are the low-lying areas of equatorial Africa and Papua New Guinea with a rainfall of over 60 cm per year and a minimum temperature of 16°C.

The endemic and sporadic forms of BL are both monoclonal tumours of B lymphocytes which have indistinguishable histological appearances. However, whereas almost 100% of African BL is associated with EBV, only around 12% of the sporadic cases are EBV-related.

Seroepidemiology

In the areas of Africa where BL is endemic almost all children over the age of 2 years have been infected by EBV and have IgG antibodies to VCA. However, in BL the pattern of EBV-associated antibodies is altered when compared to normal matched controls. Sera from BL patients have IgG antibody

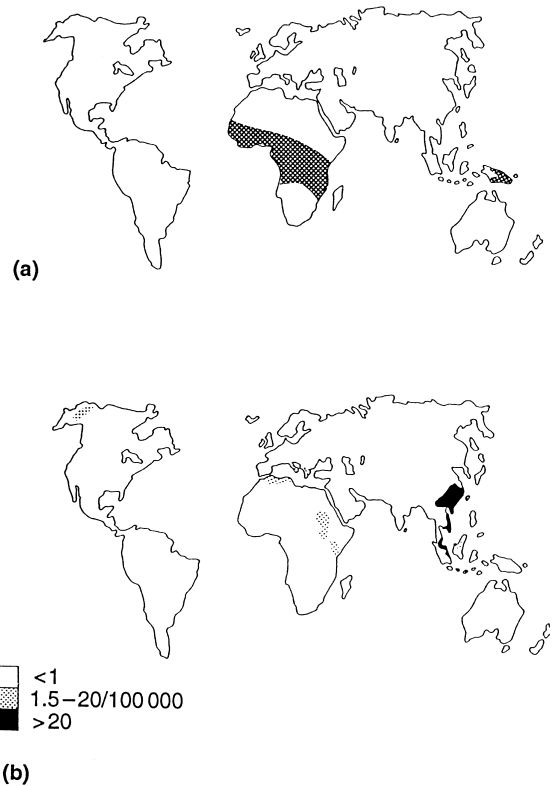

Figure 2D.8 Maps showing the worldwide distribution of (a) Burkitt's lymphoma, and (b) nasopharyngeal carcinoma

titres to VCA with a geometric mean 8–10 times greater than matched control sera. IgG anti-EA (R) and anti-MA antibodies are also raised, and the levels of these serum antibodies vary with clinical events. Thus after treatment, a drop in anti-EA (R) indicates a good prognosis, whereas a rise in anti-EA (R) and a fall in anti-MA may precede a recurrence of clinical disease.

A 7 year prospective epidemiological study carried out in Uganda by de Thé *et al.* (1978) followed 42 000 children, from whom 12 cases of BL emerged. Study of serial serum samples showed that those children who developed BL had high titres of anti-VCA months or years before the onset of the disease, indicating that BL does not result directly from primary infection with the virus. The study showed a 30 times increased risk of disease in those children with an anti-VCA titre of two doubling dilutions or more above the normal control population.

Pathogenesis

Association with EBV

Although it is very difficult to obtain absolute proof that a virus is involved in the aetiology of a tumour in humans, the following facts support the widely accepted view that EBV is involved in the aetiology of BL. Multiple copies of the viral genome can be detected in the tumour cells of around 97% of African BL biopsy samples by *in situ* hybridization techniques. Furthermore, the EBV-coded antigen EBNA 1 is expressed in all the malignant cells, although its function in tumour development is unclear. Cell lines grown from tumour biopsy material express EB viral antigens and may produce infectious EBV particles. Seroepidemiological evidence shows that children with African BL have high titres of antibodies to EB viral antigens which show a unique pattern of reactivity and vary in association with the clinical course (see above). Finally, the immortalizing potential of EBV is confirmed by its ability to growth transform B lymphocytes *in vitro* (see page 122) and to cause tumours in subhuman primates, although phenotypically these primate tumours resemble the lymphoma arising in immunosuppressed individuals (see page 136) rather than BL.

BL-derived Cell Lines

Lymphoid cell lines which are grown directly from BL biopsy material, show the characteristic features of BL cells, with cellular markers consistent with a germinal centre B cell phenotype and viral gene expression to restricted EBNA 1. These differ from their *in vitro*, EBV-immortalized counterpart (see page 122) in several important respects which indicate their increased malignant potential. Thus, BL-derived cell lines will grow as colonies in soft agar and subcutaneously in nude mice, whereas *in vitro* immortalized LCIs will not. BL cell lines are monoclonal, with all cells bearing surface immunoglobulin of one heavy chain isotype (usually M) and one light chain type, whereas *in vitro* immortalized cell lines are polyclonal in origin. There are also differences in growth characteristics, cellular gene expression and cytological appearances between the two cell line types. However, with prolonged culture, the viral and cellular gene expression in BL cell lines drifts to resemble LCLs. Finally, BL cell

lines consistently carry specific chromosomal translocations which are never present in *in vitro*-grown cell lines derived from normal individuals (see below).

Chromosomal Abnormalities

It has been recognized for many years that fresh BL tumour cells and the derived cell lines show a reciprocal chromosomal translocation between the long arm of one chromosome 8 and chromosomes 14, 2 or 22. Each of these translocations results in the association of the *c-myc* oncogene from chromosome 8 with either the immunoglobulin heavy chain genes on chromosome 14 or the κ or λ light chain genes on chromosomes 2 and 22, respectively. *C-myc* is a normal cellular gene which codes for a nuclear protein involved in the control of cell activation and proliferation. The BL translocations deregulate the gene, giving constitutive expression, which is considered to be important for the continued proliferation and lack of differentiation of the BL cell.

Cofactors in the Pathogenesis of BL

Since EBV is a ubiquitous agent, whereas EBV-associated BL occurs almost exclusively in those geographical areas of the world where malaria is holoendemic, it is probable that malaria infection acts as one factor in the multifactorial aetiology of this disease. The association between BL and malaria is further substantiated by the finding that, where malaria eradication has been successfully accomplished, the incidence of BL has dropped dramatically. Furthermore, the incidence of BL in children with the sickle cell trait, which confers partial protection from malaria, is low.

It has been shown that children in the Gambia, West Africa, have decreased EBV-specific cytotoxic T cell activity and increased numbers of EBV-infected B cells in the peripheral blood during an attack of malaria (Whittle *et al.*, 1984; Lam *et al.*, 1991). It is postulated, therefore, that the combined lymphoid stimulation and immunosuppressive effects of malaria cause an increase in B cell turnover and a decrease in the elimination of EBV genome-carrying B cells. This in turn increases the chance of a B cell clone bearing a chromosomal translocation appearing and being infected by EBV.

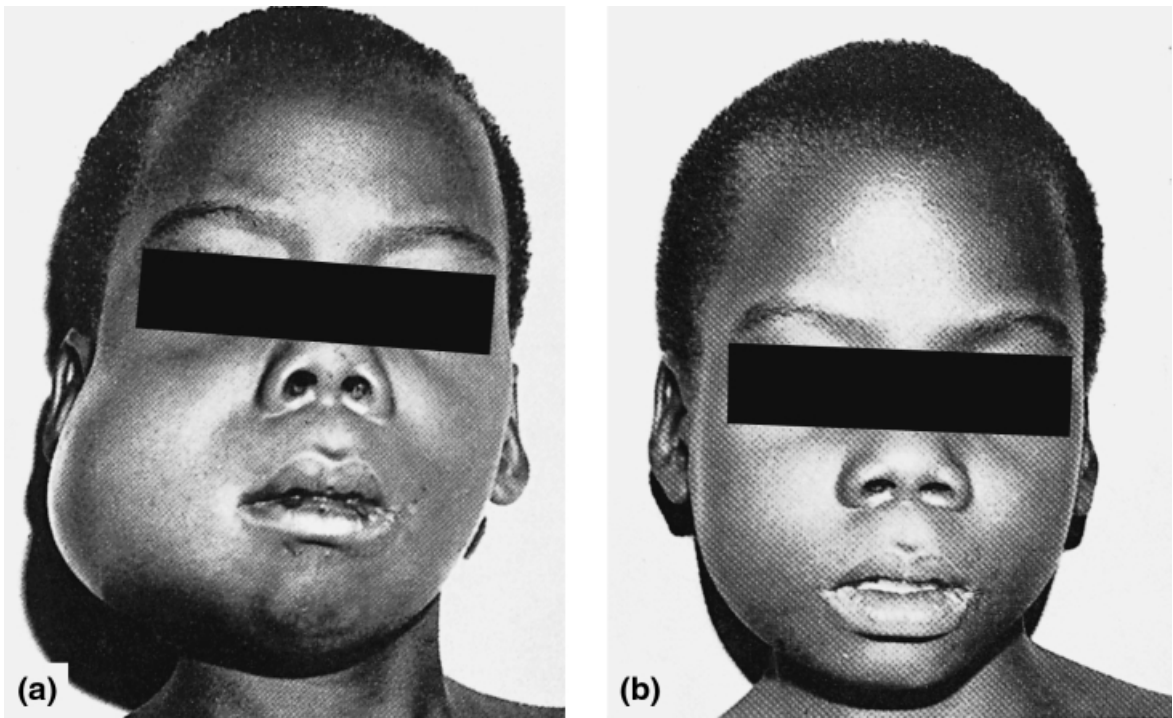

Figure 2D.9 Male child with a Burkitt's lymphoma of the jaw (a) before treatment and (b) after treatment with cyclophosphamide (30 mg per kg body weight)

Clinical Features

African BL is a tumour which occurs in children aged 3–15 years, with a peak age incidence of 6–7 years. In those areas of Africa and Papua New Guinea where BL is endemic it occurs with an incidence of 15 per 100 000 children aged 5–10 years, and is the commonest malignancy in this age range. It is more common in boys than girls and arises extranodally, typically in the area of the jaw, giving a characteristic presentation (Figure 2D.9). The tumour is usually found to be multifocal at presentation, the other sites commonly involved being the postorbital region, gastrointestinal tract, thyroid, liver, kidney, skeleton, testicles and the ovaries, and the breast in pubertal girls.

BL is a highly malignant tumour, with death supervening within a few months of clinical onset in untreated cases. The tumour is, however, sensitive to chemotherapy.

Diagnosis

The diagnosis of BL in an endemic area is very often clear from the clinical features described above; however, histological evidence should be sought (Figure 2D.10). The tumour shows a characteristic histological picture of a diffuse monomorphic infiltrate of medium-sized blast cells with variable numbers of infiltrating histiocytes giving the classic 'starry sky' appearance. BL is a monoclonal tumour of B cell origin, and in over 90% of cases the cells express surface IgM.

Treatment

Burkitt lymphoma is very sensitive to chemotherapy, one dose of cyclophosphamide often being enough to cause complete regression of the tumour mass. Relapses do occur, however, and are progressively less responsive to therapy. For this rea-

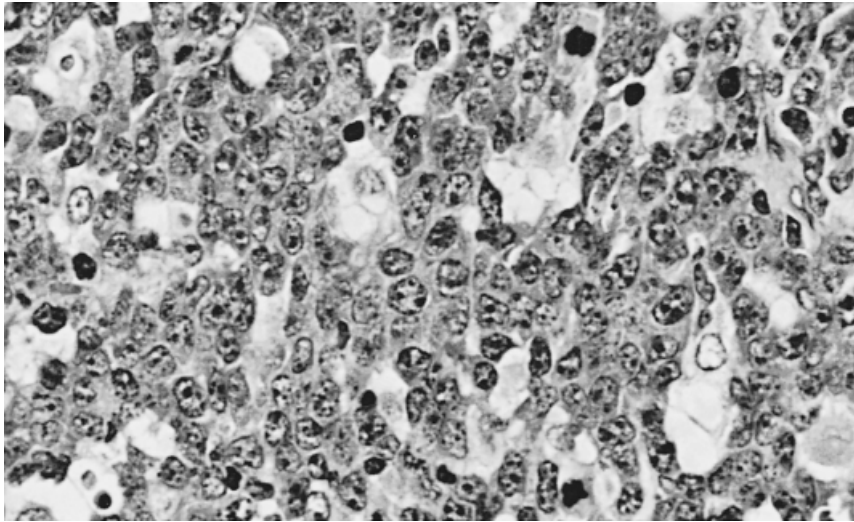

Figure 2D.10 Histological section of Burkitt's lymphoma, showing a uniform population of nucleolated lymphoid cells and scattered vacuolated macrophages (H & E, $\times 800$). (Courtesy of Professor P. Isaacson, University College Hospital)

son a full course of treatment should be given initially, in which case the prognosis is good.

the rarer, the more differentiated forms, is controversial.

Prevention

The prevention of BL may theoretically be achieved either by the eradication of malaria, which is probably a necessary cofactor in the disease, or by the prevention of EBV infection by vaccination (see page 138).

Where the eradication of malaria has been achieved in small areas, such as some of the islands of Papua New Guinea, and the incidence of BL has fallen.

NASOPHARYNGEAL CARCINOMA

Nasopharyngeal carcinoma (NPC) is a malignant tumour of the squamous epithelium of the nasopharynx, which is very prevalent in southern China, where it is the commonest tumour in men and the second most common in women. In most other areas of the world the tumour is rare, but pockets of high incidence occur in North and Central Africa, Malaysia, Alaska and Iceland (Figure 2D.8). The most undifferentiated form of the tumour, which occurs most commonly, is always associated with EBV, whereas the association with

Seroepidemiology

The association between NPC and EBV was first demonstrated serologically (Old *et al.*, 1966) and this study has been extended to show that 100% of sera from cases of undifferentiated NPC have high-titre antibodies to the EB viral antigen VCA, regardless of their geographical location. As in BL, the antibodies are present at a ten times higher geometric mean titre than in matched controls, and show a unique reaction pattern. Thus the anti-EA (D) component is the most frequently seen and is present at a higher titre than anti-EA (R). IgG and IgA anti-EA (D) antibody titres rise as the disease progresses and fall in remissions. They can be undetectable in long-term survivors. Similarly, IgA antibodies to VCA are present in NPC sera and correlate with disease progression. These IgA antibodies are also found uniquely in the saliva of NPC patients.

Pathogenesis

Association with EBV

As with BL, it is difficult to distinguish an aetiological association between EBV and NPC from a pure-

ly passenger role for the virus in the tumour cells; however, the following evidence suggests that there is more than a casual association involved. Multiple clonal copies of the EB viral genome can be detected in the malignant epithelial cells of 100% of undifferentiated NPC biopsy specimens. All the malignant epithelial cells express the EBV-coded antigen EBNA 1, and LMP is expressed in around 50% of tumours. Seroepidemiological data show that 100% of sera from undifferentiated NPC patients have high-titre antibodies to EB viral antigens which correlate with clinical events (see above). Finally, the malignant epithelial cells from NPC produce EBV particles when explanted into tissue culture following growth in nude mice to remove the non-malignant, infiltrating lymphocytes. This NPC-derived virus has been shown to be distinguishable to EBV derived from other sources.

Cofactors in the Pathogenesis of NPC

NPC is a genetically restricted tumour, being most common in the southern Chinese. It has an intermediate frequency in some Negroid and Mongoloid races and is rare in Caucasians. It has been noted that the first-generation immigrants from southern China to the USA retain the high frequency of the disease, although later generations show a declining incidence, which may be due to intermarriage with non-Chinese races. These data strongly suggest a genetic factor in the aetiology of the disease, and this is backed up by family clustering and the finding that the HLA haplotype A₂BW36 confers a 4–6 times increased risk of disease. Environmental factors have also been suggested in the aetiology of NPC, in particular dietary components, such as salted fish, and phorbol ester contamination of soil and food by common local plants (Ito, 1986).

Clinical Features

NPC occurs at a rate of 98 per 100 000 of the population in southern China and is more common in men than in women. The age of onset of NPC varies with geographical distribution and histological type, the undifferentiated type being more common in high-risk areas in young patients, whereas the more differentiated types occur in older patients and constitute the bulk of sporadic cases.

The tumour most commonly arises on the posterior wall of the nasopharynx in the fossa of Rosenmüller, where it often remains silent, and rapidly metastasizes to the draining lymph nodes. Thus the most frequent presenting symptoms of NPC is bilateral enlargement of lymph glands in the neck, which are firm, non-tender and fixed. The upper cervical chain of glands are most often involved in the initial spread. At this stage the primary tumour may be very small and difficult to locate. Less frequently the presenting symptoms are associated with invasion by the primary tumour, and include nasal obstruction, postnasal discharge, epistaxis, partial deafness and cranial nerve palsies. If untreated, the disease is rapidly fatal, with death being most often due to laryngeal and pharyngeal obstruction.

Diagnosis

The diagnosis of NPC is often made on biopsy material from an enlarged cervical lymph node. The cells are squamous epithelial in origin and three histological types are described in the World Health Organization classification: (1) a well-differentiated squamous cell carcinoma with intercellular bridges and/or keratinization; (2) a non-keratinizing carcinoma; and (3) an undifferentiated carcinoma in which a heavy lymphocytic infiltration is often present which may be so extensive as to lead to the mistaken diagnosis of lymphoma (Figure 2D.11). However, the lymphocytes, which are mainly T cells, are non-malignant. The term 'lympho-epithelioma' has been used to describe this third type, which occurs most commonly in the high-risk areas.

Serum antibody titres to EBV antigens can be used to confirm the diagnosis of NPC and to monitor the progress of the disease. Large-scale screening programmes have been undertaken in China, and those individuals with persistent IgA antibodies to VCA in serum samples have been followed up. NPC has developed in some, and 'precancerous' lesions have been diagnosed in others. It is hoped that this type of project may lead to early treatment and a reduced mortality from NPC. IgA antibodies to VCA and EA in the saliva are considered diagnostic of NPC.

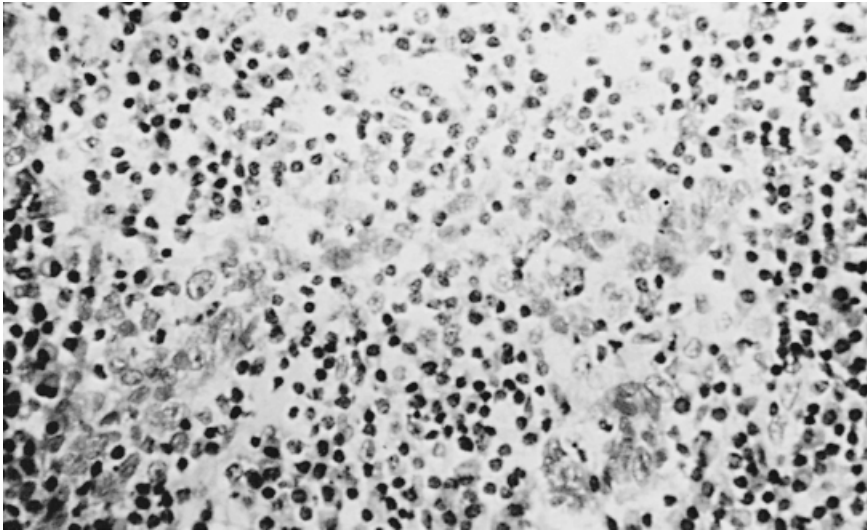

Figure 2D.11 Histological section of undifferentiated nasopharyngeal carcinoma, showing scattered malignant epithelial cells and a heavy infiltrate of small lymphocytes. (H & E, $\times 400$)

Treatment

NPC is difficult to treat surgically because of the characteristic feature of early metastasis to regional lymph nodes. The tumour is resistant to chemotherapy, and therefore radiotherapy to the primary tumour and cervical lymph node field is the treatment of choice. The prognosis is poor, with a 5 year survival of less than 20%.

Prevention

Although the actual role of EBV in the aetiology of NPC remains to be elucidated, it has argued that prevention of primary infection by EBV using vaccination may be enough to break the chain of events which culminates in tumour formation. The vaccine preparation is discussed on page 138.

HODGKIN'S DISEASE

It has been known for many years that Hodgkin's disease (HD) is more common in people who have previously had IM, and that patients have high antibody titres to EB viral lytic cycle antigen. Recently EBV has been firmly associated with a subset of HD by the demonstration of the viral genome

and the expression of viral-coded antigens in the malignant Reed–Sternberg (R-S) cells. Thus multiple copies of clonal circular EB viral DNA can be detected in 40–60% of HD tissue by Southern blotting, with confirmation of the R-S cell location by *in situ* hybridization (Anagnostopoulous *et al.*, 1989). These cells also express EBNA 1 and high levels of LMP 1 in the absence of other EBNA proteins. The nodular sclerosing and mixed cellularity types of HD are most often associated with EBV, but the exact nature of this association, and its relevance to HD aetiology, remains to be elucidated. No clear clinical distinction can be drawn between EBV positive and negative HD.

EBV INFECTION IN THE IMMUNOCOMPROMISED HOST

In common with the other human herpesviruses, EBV infects most of the adult population, and after primary infection the virus is not completely eliminated from the body but remains as a persistent infection for life. Control of this persistent infection is probably primarily cell-mediated, and T lymphocytes can be found in the peripheral blood of all normal seropositive individuals which are specifically cytotoxic for autologous EBV-infected B lymphocytes (see page 124). It is not surprising there-

fore that, in those conditions in which there is a decrease in cell-mediated immunity, there is increased EBV replication in the throat, high antibody titres to lytic cycle antigens (VCA and EA) and increased numbers of circulating, virus-carrying B cells. This pattern is called a reactivated infection, although generally no clinical symptoms ensue. In a few patients, however, EBV-associated lymphoproliferative lesions and lymphoma develop.

X-linked Lymphoproliferative Syndrome (X-LPS)

This syndrome (first called Duncan's syndrome) was recognized in 1974 by Purtilo and colleagues, who described a family in which six male kindred died of acute IM and/or malignant lymphoma (Purtilo *et al.*, 1974). Since then many such families have been reported, with affected members having an apparent inability to mount an effective cell-mediated immune response to primary EBV infection. The defective gene is located on the X chromosome and has recently been cloned (Coffey *et al.*, 1998; Sayos *et al.*, 1998). It codes for a protein which regulates T cell activation.

Clinically the affected males are healthy until primary EBV infection occurs. The course of the disease is then either fulminating and rapidly fatal or it may progress to a chronic phase, often culminating in a fatal, B cell lymphoproliferation. These tumours often occur in the central nervous system or gastrointestinal tract. Hypogammaglobulinaemia, agranulocytosis and aplastic anaemia have also been reported following IM in some of these patients.

Many abnormal laboratory findings have been reported in X-LPS, although none are consistently found. These include defective natural killer cell activity and a reduction in EBV-specific T cell cytotoxicity. The pattern of antibodies to EB viral antigens may be abnormal, with high anti-VCA and EA antibodies and low anti-EBNA antibodies. This pattern is identical to that seen in many immunosuppressed states. Female carriers of the abnormal X chromosome may show a milder derangement of antibody pattern and can in that case be recognized in a family where a fatal case of IM has occurred. Carriers generally have normal EBV-specific T cell killing.

Histological studies on fatal cases of IM show infiltration of the tissues with activated T cells and EBNA + lymphoblastoid and plasmacytoid cells which are polyclonal in origin. The solid lymphomas which develop at a later stage in the disease have been variously described as polyclonal or monoclonal, and may in fact progress from the former to the latter. There is no elective treatment for this disease, although interferon and acyclovir have been reported as helpful in the early stages.

Transplant Recipients

It is well known that there is an increased incidence of malignancy following organ transplantation and concomitant immunosuppression, and around 20% of this is accounted for by malignant lymphoma. These are mainly classified as large cell lymphomas which develop in 1–10% of patients following solid organ transplantation. The tumours tend to occur in the central nervous system, or in lymphoid tissue in the gastrointestinal tract or the transplanted organ. Over 90% of these tumours carry the EB viral genome and the tumour cells generally express all the latent viral genes. Examination of lymphoproliferative lesions from multiple sites for immunoglobulin gene rearrangement reveals that most are monoclonal in origin, although separate clones may proliferate at each individual site. However, progression from a polyclonal lymphoproliferative lesion to a monoclonal lymphoma has also been described. Serological studies in transplant recipients show that, in around 50% of those developing EBV-associated lymphoma, there is evidence of a recent primary infection.

The immunosuppressive therapy following transplantation reduces the T cell-mediated immunity to EBV (Crawford *et al.*, 1981), and it is therefore postulated that, in the absence of specific immune mechanisms, EBV-infected B lymphocytes proliferate in an uncontrolled manner. This postulate is strengthened by the finding of regression of some of these lesions when the immunosuppressive therapy is reduced or withdrawn. This is now the first line of treatment, and the antiviral drug acyclovir is sometimes added to this regimen, but its role in tumour regression is unclear. However, relapse and recurrence are common, and recently donor-derived EBV-specific cytotoxic T cells grown *in vitro* have

been used to prevent or treat EBV-associated B lymphoproliferative disease in bone marrow transplant recipients (Rooney *et al.*, 1995).

Acquired Immune Deficiency Syndrome (AIDS)

With the profound cellular immunodeficiency seen in patients infected with human immunodeficiency virus (HIV) it is not surprising that EBV-associated lymphomas frequently occur, and these are included in the CDC diagnostic criteria for AIDS. However, whereas some of these tumours are of the large cell histological type seen in the other immunodeficiency states, others are of the BL phenotype. The latter tumours are monoclonal and around 50% show the cellular and viral gene expression described for African BL (page 132). The other 50% are EBV negative. The finding of BL in AIDS patients as well as African children led to the suggestion that the polyclonal activation of B cells, caused by both malaria and HIV infections, may in some way predispose to the development of BL (Lenoir and Bornkamm, 1987). This could act by increasing B cell turnover, thereby increasing the likelihood of a *c-myc* gene translocation and EBV infection occurring in the same cell.

Oral hairy leucoplakia (OHL) was first described in HIV-seropositive individuals, forming multiple characteristic corrugated white lesions on the lateral margin of the tongue. DNA hybridization and immunocytochemical staining techniques have demonstrated EBV replicating in these lesions (Greenspan *et al.*, 1985). OHL has now been recognized in other groups of immunocompromised patients. The lesion is painless and apparently harmless, but it can be successfully treated if required with continuous acyclovir therapy.

VACCINE DEVELOPMENT

Over the last two decades work has been undertaken to develop a vaccine which would prevent primary infection by EBV. It is argued that this would prevent the development of BL and NPC by breaking a link in the chain of events which leads to the evolution of these diseases (Epstein, 1984). Such a vaccine preparation would have to be given very

early in life to prevent natural infection in the BL- and NPC-susceptible populations. An effective vaccine preparation could also be useful in seronegative organ transplant recipients, and perhaps even those at risk of developing severe IM, such as male offspring of X-LPS carriers.

The antigen chosen for vaccine development is the MA antigen gp340/220 (page 122), since it is this antigen to which neutralizing antibodies are mainly directed. Cotton top tamarins have been used as an animal model for testing vaccine preparations, since these animals develop EBV-associated tumours after inoculation with EBV. Preinoculation of gp 340/220, presented in immune-stimulating complexes, protects the tamarins from virus challenge (Morgan *et al.*, 1988). It remains to be seen whether this vaccine will be effective in humans.

REFERENCES

- Anagnostopoulos, I., Herbst, H., Niedobitek, G. *et al.* (1989) Demonstration of monoclonal EBV genomes in Hodgkin's disease and ki-1 positive anaplastic large cell lymphoma by combined Southern blot and *in situ* hybridisation. *Blood*, **74**, 810–816.
- Bear, R., Bankier, A.T., Biggin, M.D. *et al.* (1984) DNA sequence and expression of the B95–8 Epstein-Barr virus genome. *Nature*, **310**, 207–211.
- Borysiewicz, L.K., Haworth, S.J., Cohen, J. *et al.* (1986) Epstein-Barr virus-specific immune defects in patients with persistent symptoms following infectious mononucleosis. *Quarterly Journal of Medicine*, **58**, 111–121.
- Burkitt, D. (1958) A sarcoma involving the jaws in African children. *British Journal of Surgery*, **46**, 218–223.
- Coffey, A.J., Brooksbank, R.A., Brandau, O. *et al.* (1998) Host response to EBV infection in X-linked lymphoproliferative disease results from mutations in an SH2-domain encoding gene. *Nature Genetics*, **20**, 129–135.
- Crawford, D.H., Thomas, J.A., Janossy, G. *et al.* (1980) Epstein-Barr virus nuclear antigen positive lymphoma after cyclosporin A treatment in patient with renal allograft. *Lancet*, **i**, 1355–1356.
- Crawford, D.H., Sweny, P., Edwards, J.M.B. *et al.* (1981) Long term T-cell mediated immunity to Epstein-Barr virus in renal allograft recipients receiving cyclosporin A. *Lancet*, **i**, 10–12.
- Davidsohn, I. and Henry, J.B. (1969) *Clinical Diagnosis by Laboratory Methods*, 14th edn (eds Todd and Sanford). W.B. Saunders, Philadelphia.
- de Thé, G., Geser, A., Day, N.E. *et al.* (1978) Epidemiological evidence for causal relationship between Epstein-Barr virus and Burkitt's lymphoma from Ugandan prospective study. *Nature*, **274**, 756–761.
- Downey, H. and McKinlay, C.A. (1923) Acute lymphadenitis compared with acute lymphatic leukaemia. *Archives of Internal Medicine*, **32**, 82–112.

- Epstein, M.A. (1984) Leeuwenhoek lecture 1983. A prototype vaccine to prevent Epstein-Barr virus-associated tumours. *Proceedings of the Royal Society B*, **221**, 1–20.
- Epstein, M.A. and Barr, Y.M. (1964) Cultivation *in vitro* of human lymphoblasts from Burkitt's lymphoma. *Lancet*, **i**, 702–703.
- Epstein, M.A., Barr, Y.M. and Achong, B.G. (1964) Virus particles in cultured lymphoblasts from Burkitt's lymphoma. *Lancet*, **i**, 702–703.
- Greenspan, J.S., Greenspan, D., Lennette, E.T. *et al.* (1985) Replication of Epstein-Barr virus within the epithelial cells of oral 'hairy' leukoplakia: an AIDS-associated lesion. *New England Journal of Medicine*, **313**, 1564–1571.
- Henle, G. and Henle, W. (1966) Immunofluorescence in cells derived from Burkitt's lymphoma. *Journal of Bacteriology*, **91**, 1248–1256.
- Henle, G., Henle, W. and Klein, G. (1971) Demonstration of two distinct components in the early antigen complex of Epstein-Barr virus-infected cells. *International Journal of Cancer*, **8**, 272–282.
- Imai, S., Koizumi, S., Sugiura, M. *et al.* (1994) Gastric carcinoma: monoclonal epithelial malignant cells expressing Epstein-Barr virus latent protein. *Proceedings of the National Academy of Sciences*, **91**, 9131–9135.
- Ito, Y. (1986) Vegetable activations of the viral genome and the causation of Burkitt's lymphoma and nasopharyngeal carcinoma. In *The Epstein-Barr Virus: Recent Advances* (eds MA Epstein and BG Achong), pp 207–236. Heinemann, London.
- Jones, J.F., Shurin, S., Abramowski, C. *et al.* (1988) T cell lymphomas containing Epstein-Barr viral DNA in patients with chronic Epstein-Barr virus infections. *New England Journal of Medicine*, **318**, 733–741.
- Kikuta, H., Sakiyama, Y., Matsumoto, S. *et al.* (1993) Fatal Epstein-Barr virus associated hemophagocytic syndrome. *Blood*, **82**, 3259.
- Lam, K.M.-C., Syed, N., Whittle, H. *et al.* (1991) Circulating Epstein-Barr virus-carrying B cells in acute malaria. *Lancet*, **337**, 876–878.
- Lenoir, G. and Bornkamm, G. (1987) Burkitt's lymphoma: a human cancer model for the study of the multistep development of cancer. Proposal for a new scenario. *Advances in Viral Oncology*, **6**, 173–206.
- Morgan, A.J., Finerty, S., Lougren, K. *et al.* (1988) Prevention of Epstein-Barr (EB) virus-induced lymphoma in cotton top tamarins by vaccination with the EB virus envelope glycoprotein gp 340 incorporated into immune-stimulating complexes. *Journal of General Virology*, **69**, 2093–2096.
- Murray, R.J., Kurilla, M.G., Brooks, J.M. *et al.* (1992) Identification of target antigens for the human cytotoxic T cell response to Epstein-Barr virus (EBV): implication for the immune control of EBV-positive malignancies. *Journal of Experimental Medicine*, **176**, 157–168.
- Nemerow, G.R., Wolfert, R., McNaughton, M.E. *et al.* (1985) Identification and characterisation of the EBV receptor (CR2). *Journal of Virology*, **55**, 347–351.
- Niederman, J.C., Evans, A.S., Subrahmanyam, L. *et al.* (1970) Prevalence incidence and persistence of EB virus antibody in young adults. *New England Journal of Medicine*, **282**, 361–365.
- Old, L.J., Boyse, E.A., Oettgen, H.F. *et al.* (1966) Precipitating antibody in human serum to an antigen present in cultured Burkitt's lymphoma cells. *Proceedings of the National Academy of Sciences of the USA*, **56**, 1699–1704.
- Purtilo, D.T., Cassel, C. and Yang, J.P.S. (1974) Fatal infectious mononucleosis. *New England Journal of Medicine*, **291**, 736.
- Reedman, B.M. and Klein, G. (1973) Cellular localisation of an Epstein-Barr virus (EBV)-associated complement-fixing antigen in producer and non-producer lymphoblastoid cell lines. *International Journal of Cancer*, **11**, 499–520.
- Rooney, C.M., Smith, C.A., Ng, C.Y.C. *et al.* (1995) Use of gene-modified virus-specific T lymphocytes to control Epstein-Barr-virus-related lymphoproliferation. *Lancet*, **345**, 9–12.
- Sayos, J., Wu, C., Morra, M., *et al.* (1998) The X-linked lymphoproliferative-disease gene product SAP regulates signals induced through the co-receptor SLAM. *Nature*, **395**, 462–469.
- Sixbey, J.W., Nedrud, J.G., Raab-Traub, N. *et al.* (1984) Epstein-Barr virus replication in oropharyngeal epithelial cells. *New England Journal of Medicine*, **310**, 1225–1230.
- Sutkowski, N., Palkama, T., Ciurli, C. *et al.* (1996) An Epstein-Barr virus-associated superantigen. *Journal of Experimental Medicine*, **184**, 971–980.
- Tierney, K.J., Steven, N., Young, L.S. *et al.* (1994) Epstein-Barr virus latency in blood mononuclear cells: analysis of viral gene transcription during primary infection and in the carrier state. *Journal of Virology*, **68**, 7374–7385.
- University Health Physicians and Public Health Laboratory Service Laboratories (1971) Infectious mononucleosis and its relationship to EB virus antibody. *BMJ*, **5**, 643.
- Whittle, H., Brown, K., Marsh, K. *et al.* (1984) T-cell control of Epstein-Barr virus-infected B cells is lost during *P. falciparum* malaria. *Nature*, **312**, 449–459.
- Wolf, H., Zur Hansen, H. and Becker, V. (1973) EBV viral genomes in epithelial nasopharyngeal carcinoma cells. *Nature New Biology*, **244**, 245–247.

Human Herpesviruses 6 and 7

Ursula A. Gompels

London School of Hygiene & Tropical Medicine, University of London, UK

OVERVIEW

In this chapter the biology and clinical aspects of *Human herpesviruses 6* and *7* (HHV-6 and HHV-7) are reviewed. These are primarily infant fever viruses which, like other herpesviruses, become latent but may reactivate later to cause disease, usually during immunosuppression, such as in the acquired immune deficiency syndrome (AIDS) or transplant patients.

HHV-6 and HHV-7 are the only true 'lymphotropic' herpesviruses, in that the lymphocyte allows fully permissive replication as opposed to being merely a source of persistent infection, as is the case for some other herpesviruses. They infect and kill CD4+ helper T lymphocytes. This property raises interesting questions such as their role as immunosuppressive agents, and mechanisms of immune evasion. Recent results also point towards associations with certain neurological conditions. Thus, the relation between blood-borne infectious agents and the central nervous system (CNS) raises further intriguing questions.

Paradoxically, although these viruses target and kill the same cells as HIV, they also infect most of the population before the age of 1 year, rising to up to 100% seroconversion in adults, yet all adults obviously do not develop AIDS. What then are the differences between these infections, when are these viruses associated with pathology, and how can they infect and persist in cells which are normally part of the cellular branch of protective immunity?

GENERAL PROPERTIES

Biology

HHV-6 and HHV-7 are closely related and belong to the betaherpesvirus subgroup. As shown in Figure 2E.1, a similar relationship also exists within the alphaherpesvirus subgroup, between *Herpes simplex virus types 1* and *2* (HSV-1 and HSV-2, official ICTV nomenclature HHV-1 and HHV-2). HHV-6 was first isolated in the USA in 1986 (strain 'GS' originally called HBLV) during routine culture for HIV from the blood of an AIDS patient. An unusual cytopathic effect was observed showing both fused and 'balloon' cells in the lymphocyte culture (Figure 2E.2). Similar effects had been noted in cultures from African AIDS patient and further isolations were made from blood from Ugandan and Gambian AIDS patients which were characterized in the UK as new T-lymphotropic herpesviruses, strains U1102 and AJ. Subsequently, another isolate was described in the USA from a Zairian AIDS patient, strain Z29. All these strains have been used as prototype laboratory strains, but most study has centred on strain U1102, for which complete genomic clones were first available and the entire genomic sequence subsequently derived. Partial information is also available for Z29, with plans further for completion. These two strains have also been used as representatives of the strain groups, termed variant A and variant B, for strains U1102 and Z29, respectively (see below). For the above

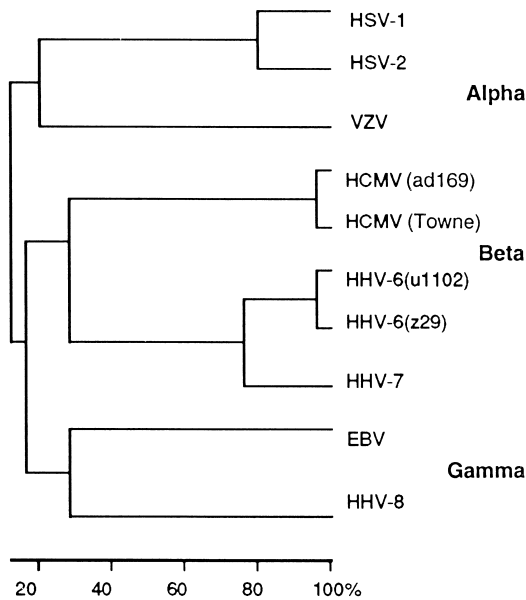

Figure 2E.1 Phylogenetic relationships between human herpesviruses. This phylogeny is based on multiple alignments of the conserved glycoprotein H amino acid sequence. Similar relationships can be drawn from alignments of other conserved proteins. HHV-6 and HHV-7 are related to HCMV within the betaherpesvirus subgroup. Strain differences within this group are indicated by strains ad169 and Towne for HCMV, and strains u1102 and z29 for HHV-6. Relationships between alpha-, beta- and gammaherpesviruses can only be determined by encoded amino acid sequences, since the nucleotide sequences are too divergent, whereas relationships between strains can be determined also by nucleotide sequence alignment which highlights their close origin

section see Gompels *et al.* (1995) and references therein.

HHV-7 was first isolated from peripheral blood mononuclear cell (PBMC) culture from an apparently 'normal' donor, strain RK. The complete genomic clones and the complete genomic sequence are available for strains JI and RK (see Nicholas (1996; Megaw *et al.* (1998) and references therein). HHV-6 is easier to cultivate in cell lines (T leukaemic), and has been used as a prototype for these lymphotropic herpesviruses; more is known about HHV-6 than HHV-7.

Both HHV-6 and HHV-7 have also been isolated from saliva, where the viruses may be secreted (Black *et al.*, 1993; Cone *et al.*, 1993b; DiLuca *et al.*, 1995). HHV-7 appears to be more frequently shed or at higher detectable levels. Unlike the other human betaherpesvirus *Human cytomegalovirus*

(HCMV), HHV-6 and HHV-7 are not frequently shed in urine (GautheretDejean *et al.*, 1997).

Growth

Both HHV-6 and HHV-7 can be cultivated in activated cord blood lymphocytes or mononuclear cells (CBL, CBMC) or in peripheral blood lymphocytes or mononuclear cells (PBL, PBMC). Cord blood is used preferentially, as infection with laboratory strains can result in reactivation of resident latent virus from adult blood (Black *et al.*, 1989; Frenkel *et al.*, 1990a; Katsafanas *et al.*, 1996). Both viruses initially infect secretory epithelium and can be shed or persist at these sites (Fox *et al.*, 1990; Leach *et al.*, 1994). In routine culture both have been adapted to grow in CD4 + T leukaemic cell lines, for example, J-JHAN (Jurkat), HSB2, or Molt-3 for HHV-6, and SupT-1 for HHV-7.

T Lymphocytes

Both HHV-6 and HHV-7 have a cellular tropism for T lymphocytes. This has been shown *in vivo* during viremia from acute infection as well as *in vitro*. The viruses infect and spread in these cells, showing a characteristic cytopathic effect of large cells (cytomegalia) and ballooning cells (Figure 2E.2). The cells are completely permissive for replication and virus production, where infection results in cell death by necrotic lysis. There is *in vitro* evidence that infection also causes cell death by apoptosis in uninfected or non-productively infected bystander cells (Inoue *et al.*, 1997; Secchiero *et al.*, 1997a). Both CD4 + , CD8 + and γ/δ T lymphocytes can be infected, but the evidence suggests that activated CD4 + T lymphocytes are the preferential target of fully permissive infection *in vivo* (Takahashi *et al.*, 1989; Lusso *et al.*, 1995). Antibody to CD3 (OKT3) has been shown to augment infection of HHV-6 in both primary (Roffman and Frenkel, 1991) and T leukaemic cell lines (H.A. Macaulay and U.A. Gompels, unpublished results). This surface T cell marker and signal transduction protein is downregulated (Furukawa *et al.*, 1994). In HHV-7 infections, the CD4 antigen has been identified as part of the cellular receptor for this virus, but appears to interact with parts of the CD4 molecule distinct from that used by HIV as a cellular receptor

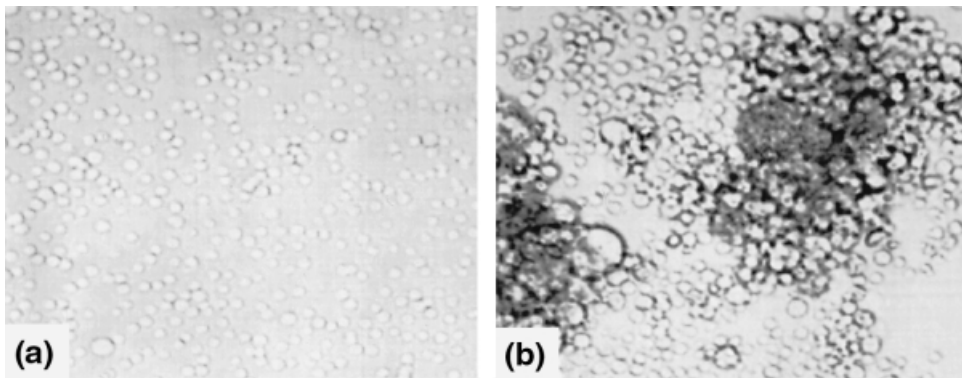

Figure 2E.2 The cytopathic effect of HHV-6 on CD4 + T lymphocytes. This shows uninfected cells (JJhan T leukaemia cell line) in (a), and infected cells 5 days postinfection in (b). The cytopathic effect includes clumped, fused cells, cytomegalia (large cells, including multinucleated) and 'balloon' cells (cells which appear to have grossly enlarged cytoplasm). Infection and cell fusion can result subsequently in cell lysis

(Lusso *et al.*, 1994). After infection the surface expression and transcriptional control are also down-regulated (Furukawa *et al.*, 1994; Secchiero *et al.*, 1997b). In contrast to HHV-7, HHV-6 upregulates CD4 expression and this can enhance infection of these cells with HIV (Lusso *et al.*, 1991a, 1995).

Salivary Gland Epithelium

In vivo antigen staining and *in situ* hybridization studies have shown that specialized cells within the salivary gland epithelium harbour persistent infections with HHV-6 and HHV-7 (Fox *et al.*, 1990; Sada *et al.*, 1996). There is virus replication at these sites and both viruses are shed (see above). HHV-7 is easier to detect and isolate from saliva than HHV-6 (DiLuca *et al.*, 1995). This is likely to be the main route of host-to-host transmission. Other routes include iatrogenic transfer with blood products or organ transplants.

Growth in Other Cell Types

The viruses may be identified *in vivo* by polymerase chain reaction (PCR) in a number of cell types, but there is no evidence that these are sites of permissive active replication. Since these are blood-borne infections, PCR detection in tissue must be controlled for blood contamination. In addition to T lymphocytes and salivary gland epithelium, there are other related relevant sites *in vivo* with evidence for active replication, including regions with specialized epithelium such as in the retina, lung, liver and

kidney, as well as lymphoid or progenitor cell types such as in the bone marrow and lymph nodes (see below). *In vitro* infection has been observed, but with limited replication, in NK cells, B lymphocytes, astrocytes, megakaryocytes, bone marrow progenitor cells, monocytic/macrophage cells, as well as hepatic, cervical and retinal epithelial cells. HHV-6 has also been identified as a commensal of the brain on the basis of sensitive PCR DNA detection and limited antigen expression (Challoner *et al.*, 1995). The exact target cell in the brain is not clear, although astrocyte or oligodendrocyte-like cells have been suggested and the virus DNA can be detected by PCR in cerebrospinal fluid of some patient groups.

Latency

Like all herpesviruses, HHV-6 and HHV-7 can establish latent infections in specialized cell types. There is evidence for latency within monocytic/macrophage cells as well as bone marrow progenitor cells (Kondo *et al.*, 1991; Gompels *et al.*, 1993;1994; Kempf *et al.*, 1997; Yasukawa *et al.*, 1997). HHV-7 can be detected by PCR in blood and saliva of asymptomatic adults in higher levels than HHV-6 (DiLuca *et al.*, 1995; Kidd *et al.*, 1996; GautheretDejean *et al.*, 1997). On this basis it has been suggested that HHV-7 may exist in a less controlled state of latency than HHV-6. Evidence has been presented that HHV-7 can reactivate

HHV-6 (Katsafanas *et al.*, 1996). Both HHV-6 and HHV-7 have been detected in cells with monocytic markers in Kaposi's sarcoma (KS) biopsies (Kempf *et al.*, 1997). It has been suggested that these cells carry latent infections and that they have been recruited and reactivated through a chemotactic response to chemoattractant cytokines in the KS lesion.

Molecular Biology

The derivation of complete genomic sequence for both HHV-6 and HHV-7 have been described, including overall reviews of their molecular biology and known functions of encoded proteins (Gompels *et al.*, 1995; Nicholas, 1996). This information is briefly summarized in the following section.

The genomes of HHV-6 and HHV-7 are respectively 153 kb and 145 kb in size. They are both bounded by terminal direct repeats of 8 and 6 kb respectively, which themselves are bounded by repeated sequences similar to the telomeric repeats (GGGTTA) at the end of human chromosomes. Roles for these sequences in replication and latency have been proposed (Gompels *et al.*, 1995). The open reading frames (ORFs) in HHV-6 strain U1102 are designated U1–U100, with those in the direct repeats as DR1–DR7 (Gompels *et al.*, 1995). In HHV-7 similar nomenclature is used, with homologous genes U2–U100 (Nicholas, 1996). A few genes are lacking in HHV-7 compared to HHV-6 but there are also a few HHV-7 specific genes, designated H1–H7 (Figure 2E.3) (Gompels *et al.*, 1995; Nicholas, 1996).

The genomes are most closely related to each other, with similarity between the encoded amino acid sequences in over 90% of the ORFs. Similarities to other vertebrate herpesviruses can be identified in only 20–30% of the ORFs, the 'conserved herpesvirus genes'. The organization of these genes can be grouped into seven gene blocks (Gompels *et al.*, 1995). The arrangement of these gene blocks is subgroup specific. HHV-6 and HHV-7 share with HCMV a betaherpesvirus organization of these gene blocks (Figures 2E.3 and 2E.4).

Analysis of HHV-6 and HHV-7 coding sequences also places them within the betaherpesvirus subgroup of the *Herpesviridae*. They share the closest relation with HCMV, the prototype betaherpes-

virus, with approximately two-thirds of the genes encoding similar proteins (Figure 2E.3). However, this relationship is distant and can only be determined by encoded amino acid sequences. Furthermore, HCMV is almost double the size, 230 kb, containing extended glycoprotein gene families absent from HHV-6 and HHV-7. HCMV is representative of beta-1 herpesviruses, and HHV-6/-7 of beta-2 herpesviruses. There are no animal herpesviruses identified to date more related to HHV-6/-7 than HCMV, although murine CMV has properties similar to all these viruses and may be used as an animal model for some features (Rawlinson *et al.*, 1996). There are HHV-6- and HHV-7-specific genes (Figure 2E.3). HHV-7 has fewer genes than HHV-6. HHV-6 encodes a Rep protein, U94, found in adeno-associated viruses (AAV) and can complement this function in replication defective AAV (Thomson *et al.*, 1994). The HHV-6 Rep gene possibly represents the first transfer of a gene between two DNA viruses, in that the amino acid sequences are more closely related to the homologue in some AAV strains than they are to each other. This Rep homologue is absent in HHV-7 and may indicate replication differences between these viruses. Both viruses have conserved and unique glycoprotein genes which mediate infection and are targets for immunological recognition (Gompels *et al.*, 1995).

The virus infects and spreads by cell fusion and candidate glycoproteins which mediate this process have been identified in each virus, the conserved gH and gL complex, encoded by HHV-6 and HHV-7 U48 and U82 (Liu *et al.*, 1993a, 1993b; Gompels *et al.*, 1995; Nicholas, 1996; Anderson and Gompels, 1999). Conserved replication and structural genes have been identified. An origin of lytic replication has been localized and characterized, plus viral genes involved in replication, including enzyme targets of established antiviral drugs, such as a viral DNA polymerase, HHV-6 and HHV-7 U38, and phosphotransferase, HHV-6 and HHV-7 U69. Unlike HCMV, HHV-6 and HHV-7 encode an origin binding protein, OBP, homologue, HHV-6 and HHV-7 U73, which is found in alphaherpesviruses. This suggests a difference in replication strategy in HCMV, although HHV-6 and HHV-7 have more complicated origins than HSV and are more similar to other betaherpesviruses. A conserved protease gene has been identified, HHV-6 and HHV-7 U53, and the specificity of the HHV-6 enzyme characterized on peptide substrates (Tigue *et al.*, 1996) and

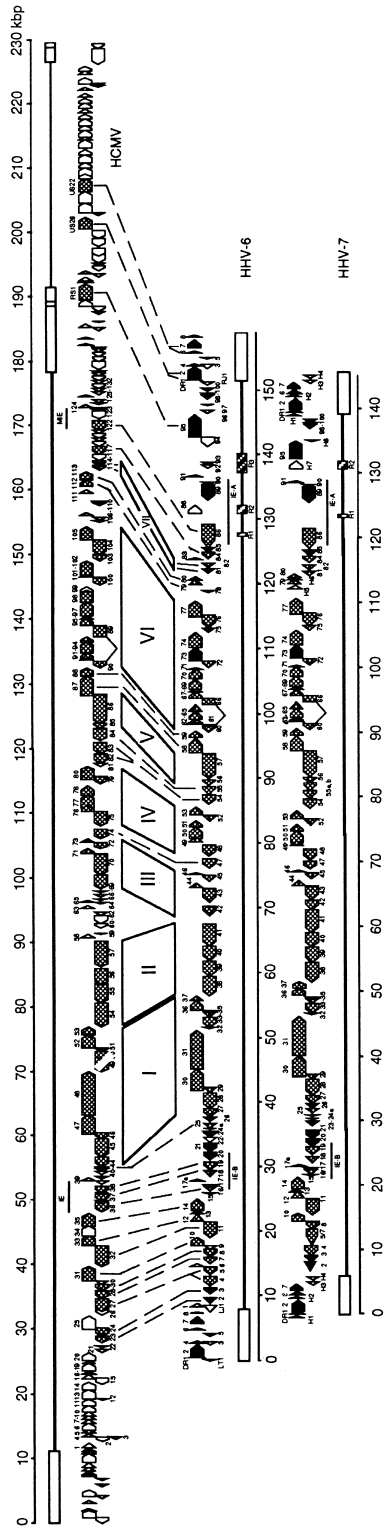

Figure 2E.3 Genome organization of HHV-6 and HHV-7 in comparison to HCMV. The coding sequences and their organization are compared between these three human betaherpesviruses. The boxes labelled I to VII indicate the seven gene blocks which encoded proteins conserved in all mammalian and bird herpesviruses studied (see text). These include functions for infection, transcriptional control, replication and morphogenesis. There are also genes which encode these functions but are either betaherpesvirus group specific or unique to each virus, reflecting biological properties characteristic of the group or the individual virus. Shaded genes indicate encoded proteins that are shared between betaherpesviruses, which include genes outside the overall gene blocks. Black genes are those shared between HHV-6 and HHV-7. Some of these genes are part of a gene family characteristic for betaherpesviruses and first described for HCMV, the US22 gene family, which include transcription factors (DR1, DR2, DR6, DR7, U2, U3, U7, U8, U16, U25 and U95). Positional homologues are indicated in HCMV, but these are not always the closest sequence homologue. White genes are specific for each virus. Genes are numbered according to their designation from respective genomic sequencing projects, and functions of selected genes are described further in the text. Regions underlined in all three viruses encode immediate-early genes which are conserved in position, designated IE-A and -B for HHV-6 and HHV-7, MIE and IE for HCMV

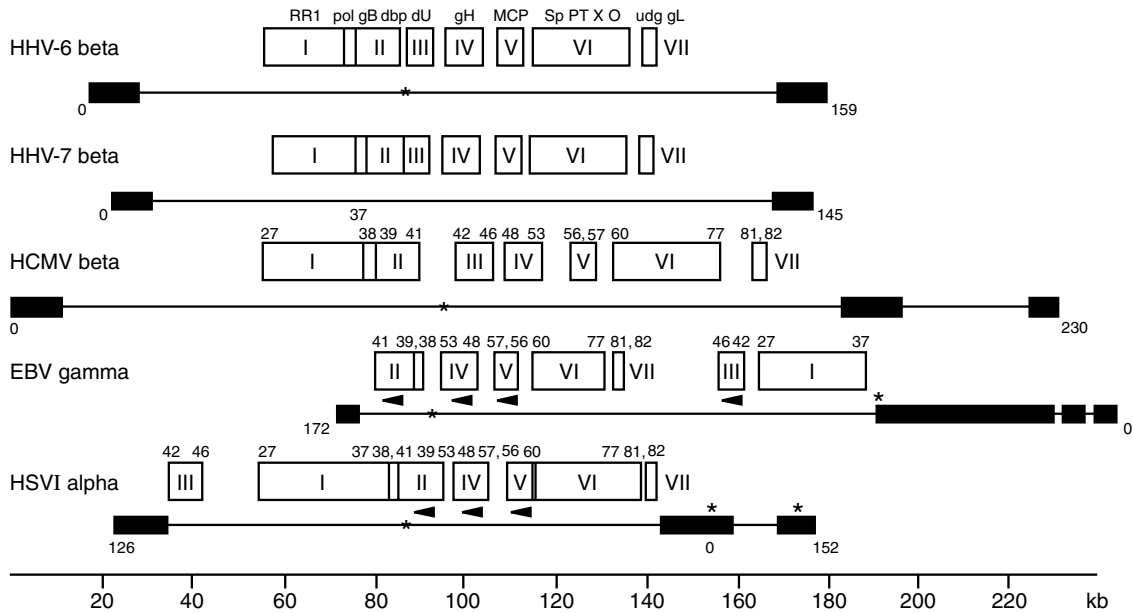

Figure 2E.4 Genome organization of HHV-6 and HHV-7 is betaherpesvirus subgroup specific. The organization of the conserved gene blocks shown in Figure 2E.3 are compared to prototypes of alpha-, beta- and gammaherpesviruses. HHV-6 and HHV-7 share a betaherpesvirus subgroup arrangement of conserved genes. Rearrangement of gene blocks are shown for HSV-1 and EBV, representing the alpha- and gammaherpesviruses, respectively. Thus the overall number of genes encoding similar products, the degree of their similarity and their overall organization group HHV-6 and HHV-7 with HCMV in the betaherpesvirus subgroup (see also Figures 2E.1 and 2E.3). By these three criterion HHV-6 and HHV-7 are also more closely related to each other than to HCMV. Genes encoding conserved functions in the gene blocks are indicated as follows: RR1 = ribonucleotide reductase subunit (u28); pol = DNA polymerase (U38); gB = glycoprotein B (U39); dbp = DNA binding protein (U41); dU = dUTPase (U45); gH = glycoprotein H (U48); MCP = major capsid protein (U57); Sp = late spliced DNA packaging gene (U60/66); PT = phosphotransferase (U69); XO = exonuclease ((U70); udg = uracil-DNA glycosylase (U81); gL = glycoprotein L (U82). Black boxes indicate repeat sequences, stars indicate positions of origins for DNA replication

full length protein (C. Parry and U.A. Gompels, unpublished results). In all herpesviruses studied, this protein cleaves itself and a product encoded by an in-frame transcript. This cleavage is essential for virus production and is a new target for antiviral therapy.

Gene regulation appears to follow the same cascade as in other herpesviruses. There are immediate-early (IE) or α genes, which include regulators of virus gene expression, followed by early (E) β genes, including enzymes for DNA replication, then late (L) or γ genes, which include structural genes for the virus particle. The IE genes are important in the switch between lytic replication and latency. One of the IE genes, HHV-6 or HHV-7 U86, encodes similarity with the IE2 protein of HCMV. Another IE gene, HHV-6 or HHV-7 U89, is unique to these viruses, although it is a positional homologue of IE1 in HCMV (Schiewe *et al.*, 1994). In HHV-6 this IE gene also shows different organization between

strain variants (Yamamoto *et al.*, 1994). The IE region has a lower CG dinucleotide frequency than expected and this feature is a mark of regions in the host genome that are subject to DNA methylation (Gompels *et al.*, 1995). Methylation can affect gene regulation and it is interesting to note that the IE regions of all betaherpesviruses have this signature CG suppression indicative of methylation. It is possible to speculate that this observation may be correlated to the observed similarities in the sites of latency between the betaherpesviruses (i.e. monocytic/macrophage and bone marrow progenitor cells), suggesting similarities in molecular mechanisms for latency.

Unique and Cellular Genes

About a third of HHV-6 and HHV-7 genes are specific to these two viruses and presumably reflect

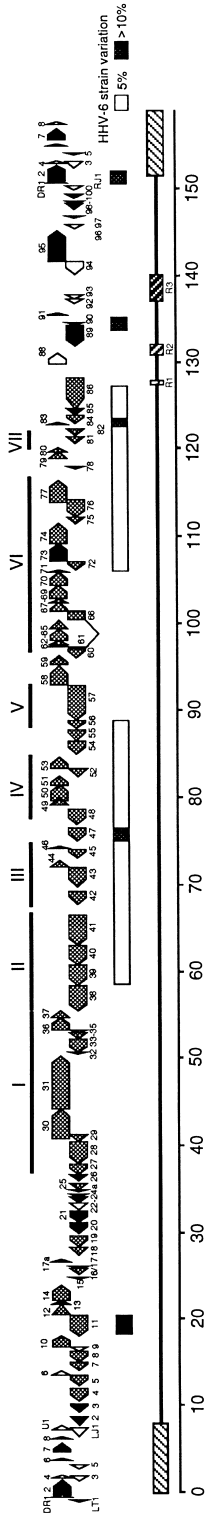

Figure 2E.5 Comparison of strain variation in HHV-6. A summary of sequence comparisons for different strains from A and B variant groups are shown. Most sequences within conserved regions (gene blocks I to VII) average sequence variation at 5% (white boxes), whereas at regions near or within repetitive sequences variation is higher (black boxes). Sometimes this is confounded by rearrangement of repeat motifs, as in the U47 glycoprotein gene, leading to higher scores of overall variation due to misalignments across these sequences. Using a region of U47 outside these repeats to analyse A and B strains from a population where both are common, there are gradual steps between 2 and 5% variation between A and B variant groups, with some strains in between these group distinctions (Kasolo *et al.*, 1997). Less variation has been observed for HHV-7 analysing a similar region (2%) (N. Obel, F. Kasolo and U.A. Gompels, unpublished results). Conserved genes indicated as for Figure 2E.3. Repetitive sequences indicated by boxes with diagonal shading

adaptations to their particular cellular tropism (Figure 2E.3). Both HHV-6 and HHV-7 also encode proteins with similarity to cellular products, chemokine receptors (U12 and U51) and members of the immunoglobulin superfamily, including an OX-2 homologue (HHV-6 and HHV-7 U85) (Gompels *et al.*, 1995; Nicholas, 1996). Distant similarities are also identified within glycoproteins encoded by other betaherpesviruses and selected gammaherpesviruses. These proteins may play a role in the ability of the viruses to persist and replicate within cells which are a normal part of cellular immunity.

Strain Variation

At least two strain groups of HHV-6 have been identified, and termed variant A and variant B by a nomenclature agreement (Ablashi *et al.*, 1993). Further subdivisions in both groups have also been described (Gompels *et al.*, 1993; Challoner *et al.*, 1995). In conserved genes strain group differences in protein or nucleotide sequences averages 5%. Greater divergence is found at the ends of the genome which are near repetitive sequences that may be mutagenic (Figure 2E.5) (Gompels *et al.*, 1995). Selected genes have higher rates of variation and correlate with regions of the genome which are rearranged in other herpesviruses (Gompels *et al.*, 1995). These genes also have higher rates of non-synonymous substitutions resulting in coding changes, which may be indicative of selection taking place at these sites (Figure 2E.5). These regions have been used as markers for variation (Gompels *et al.*, 1993; Kasolo *et al.*, 1997). Less variation has been observed for HHV-7, 2% for HHV-7 in comparison to 5% for HHV-6, even in related regions where HHV-6 variation has been observed (N. Obel, F.C. Kasolo and U.A. Gompels, unpublished results). Closely related genomic strains of HHV-7 have been reported, averaging less than 1% variation (Megaw *et al.*, 1998). Greater variation has been observed for HCMV strains and *Epstein-Barr virus* (EBV) strains, including large genomic deletions in laboratory strains (Gompels *et al.*, 1995) (Chapters 2C and 2D). Variant B strains appear to be more prevalent in studies emanating from Japan, USA, Germany, Italy and Austria; primary infection with variant A strains is rare, less than 5% of populations studied (see references in Gompels *et al.* (1995)

and Tanaka-Taya *et al.* (1996)). However, there is evidence for geographic variation, as in Zambia variant A strains have been identified in febrile infants in greater prevalence, 40% (Kasolo *et al.*, 1997). Antigenic differences between strains have been described, consistent with results for other herpesvirus strains (CampadelliFiume *et al.*, 1993; Pellett *et al.*, 1993). In addition, some differences in growth properties in leukaemic cell lines (for example Sup-T1 cells) have been noted (Ablashi *et al.*, 1993). However, later studies show efficient propagation of all strains of HHV-6 as well as HHV-7 in Sup-T1 cells (Cermelli *et al.*, 1997). These observations may reflect properties of different subclones of these leukaemic cell lines. Differences in virulence are difficult to identify, since most comparisons to date, with the exception of the Zambian study, have been made in countries where variant A strains are rare. It has been suggested that variant A strains are more virulent and have a relation to HIV/AIDS on the basis of their initial identification in AIDS patients from HIV endemic parts of Africa (Gompels *et al.*, 1995; Kasolo *et al.*, 1997), as well as data from HHV-6 variant A-related complications in USA AIDS patients (see below).

CLINICAL CHARACTERISTICS

HHV-6 is the causal agent of a paediatric fever which can present as exanthem subitum (also known as 'roseola infantum') and there can be serious complications. In secondary reactivated infection in immunosuppressed AIDS or transplant patients, disseminated infections with associated pathology have been observed. In bone marrow transplant patients, HHV-6 reactivation is related to growth suppression of some progenitor cells. The virus is an immunosuppressive agent in certain conditions. Further associations with pathologies are under evaluation.

Primary Infection in Childhood

Most causal relations have been established during the primary infection during childhood. A *de novo* primary infection can be described by seroconversion, virus isolation and high levels of virus DNA in the blood. Primary infection with HHV-6 usually

occurs after maternal immunity abates at about 6 months. Maternal antibodies are present at birth, then decrease to 6 months of age when the seropositive rate increases (Yoshikawa *et al.*, 1989; Enders *et al.*, 1990; Hall *et al.*, 1994). With age the serological titre appears to gradually decrease, but persists, and the virus establishes lifelong infections characteristic of other herpesviruses. Up to 100% of adult populations are seropositive for this virus (Yoshikawa *et al.*, 1989; Enders *et al.*, 1990; Ward *et al.*, 1993a). A similar pattern exists for HHV-7, although infection appears to occur later during infancy and early childhood, with seropositivity increasing to adulthood (Yoshikawa *et al.*, 1993; Huang *et al.*, 1997).

Childhood Fever and Rashes (Exanthem Subitum, Roseola Infantum)

Exanthem subitum was the first causal relationship to disease established for HHV-6 (Okada *et al.*, 1993; and references therein). This presents as a mild skin rash in infants and young children which is accompanied by fever (Figure 2E.6, *see* Plate III). Rare but serious complications have been reported. Recently, it has been established that HHV-7 can also cause exanthem subitum; this finding is complicated by the fact that HHV-7 usually infects later than HHV-6, and that HHV-7 can reactivate HHV-6. Furthermore, HHV-7 antibodies can cross-react with HHV-6. However, HHV-7-specific exanthem subitum has been identified (Tanaka *et al.*, 1994).

More recent and extensive studies of childhood infections with HHV-6 in a USA paediatric population of 3000 have shown that actually the primary characteristic of infant infections with HHV-6 is a high fever for 3–4 days (mean 39.4–39.7°C in different studies). Only a small proportion of these (6–10%) additionally develop the rash characteristic of exanthem subitum. These are measles- or rubella-like macular or papular rashes on the face, the trunk or both. Most diagnoses of exanthem subitum can be attributed to HHV-6 infections, although a proportion may be due to HHV-7 or dual infections. Some cases may be misdiagnosed as measles or rubella in some countries in which such infections still occur commonly (*see* below). Of those classed as infants with exanthem subitum, 80% had seroconversion or rise in HHV-

6 antibodies, with a mean age of infection at 7.3 months (Pruksananonda *et al.*, 1992; Hall *et al.*, 1994).

In exanthem subitum (ES) patients diagnosed with primary HHV-6 infection, there are other symptoms aside from fever and rash which are typical for ES. These symptoms can also occur during the more common HHV-6 febrile illness without ES rash (Hall *et al.*, 1994). These appear to be related to the level of virus replication, and include diarrhoea, respiratory symptoms, convulsions, cervical lymph node swelling and anterior fontanelle bulging (Asano *et al.*, 1991, 1994; Okada *et al.*, 1993). During primary infections there is a transient leucopenia which is consistent with virus replication and killing of lymphocytes.

In studies among children admitted to hospital with acute febrile illnesses, in the USA and Italy, aged less than 2–3 years, 10–24% were due to primary HHV-6 infection (Hall *et al.*, 1994; Portolani *et al.*, 1993). In the USA study, HHV-6 accounted for 20% of emergency ward visits from febrile illness for infants between 6 and 12 months (Hall *et al.*, 1994). In the Italian study, primary infections with this virus accounted for 40% of childhood admission to hospital for virus infections, higher by tenfold than any other identified agent (Portolani *et al.*, 1993).

There is also evidence for congenital and neonatal infections (Hall *et al.*, 1994), although the majority of children appear to be infected during infancy by horizontal transmission, probably via salivary fluid. There is no evidence for transmission by breast milk. Studies of strains in families show the strain type is conserved and that either parent or closely related adult/siblings may transmit HHV-6 or HHV-7. Evidence for sequential infection with multiple strains of HHV-6 or HHV-7 have been recorded, either asymptotically or associated with complications (*see* below) (Van Loon *et al.*, 1995; Torigoe *et al.*, 1996).

In primary infections among British children, viral load in PBMC is high as detected by quantitative DNA PCR, with 10⁴ HHV-6 or 10⁶ HHV-7 genome equivalents per 10⁶ PBMC (Clark *et al.*, 1997). Similar or higher levels of HHV-6 have been detected in whole blood of febrile infants in Zambia (Kasolo *et al.*, 1997). The virus DNA can be detected in plasma during childhood viraemia and adult reactivations but not in healthy adults (Secchiero *et al.*, 1995).

***Complications, Febrile Seizures,
Encephalitis, Bone Marrow Suppression,
etc.***

If up to 100% of populations may be infected with HHV-6 or HHV-7 even minor complication rates, although rare are of importance because the potential numbers involved are large. Complications observed in primary childhood infections with HHV-6 include skin rash (6–10%), febrile seizures (10%), hepatitis, bone marrow suppression, recurrent encephalitis, gastrointestinal (10%) and respiratory symptoms (sinusitis and pneumonitis, 10%). Some of these complications may occasionally result in a fatal outcome. (Asano *et al.*, 1990; Hall *et al.*, 1994). Fatal cases associated with haemaphagocytic syndrome have been described (Portolani *et al.*, 1997).

The appearance of primary infection can be misdiagnosed as measles or rubella infections and, conversely, measles and rubella infections may be superficially misdiagnosed as HHV-6 or HHV-7 (Black *et al.*, 1996a; Tait *et al.*, 1996; Kasolo *et al.*, 1997). Measles may reactive HHV-6 infections (Suga *et al.*, 1992). Thus, HHV-6 and HHV-7 infections need to be taken into account in any measles/rubella surveillance programme.

HHV-6 infection accounts for a third of all febrile seizures under the age of 3 (Hall *et al.*, 1994). It also is associated with recurrent seizures, meningoencephalitis and other CNS complications which may have a fatal outcome, including occasional observations of epilepsy (Asano *et al.*, 1992; Yoshikawa *et al.*, 1992; Kondo *et al.*, 1993; Suga *et al.*, 1993; Vinters *et al.*, 1993; Hall *et al.*, 1994). It is not clear whether the seizures are associated with the fever or with a direct interaction of the virus with the CNS. HHV-7 has also been associated with infant febrile convulsions during seroconversion (Clark *et al.*, 1997), as well as CNS complications during exanthem subitum (Torigoe *et al.*, 1996).

The impact of primary HHV-6 infections in developing countries has not yet been assessed where there may be other complicating factors such as malnutrition, malaria, tuberculosis or HIV. Preliminary PCR-based studies in a Zambian infant population suggest the virus is widespread and this is supported by serological studies in other parts of Africa (Kasolo *et al.*, 1997).

Primary Infection in Adults

Due to the frequency of primary infection during childhood, primary HHV-6 and HHV-7 infections in adults are rare; indeed primary infection with HHV-7 has not yet been documented among adults. For HHV-6, primary adult infection has been associated with fever and convulsions in a liver transplant patient (Ward *et al.*, 1989). It has also been associated with an infectious mononucleosis-like illness where patients are negative for HCMV and EBV. Although HHV-6 and -7 are widespread, it may be important to monitor transplant patients for both rare primary infections as well as reactivated infections. Furthermore, like other herpesviruses, after primary infection there is evidence for infections with other strains. Infection may be asymptomatic or associated with disease (Cone *et al.*, 1996; Iuliano *et al.*, 1997).

**Secondary Reactivated Infections in
Childhood**

Reactivated infections in children have been recorded shortly after the primary episode as well more distantly (Kondo *et al.*, 1993; Hall *et al.*, 1994). Complications include fever, recurrent encephalitis, recurrent febrile seizures, bone marrow suppression, rash and disseminated infections in immunosuppressed patients (see below) (Kondo *et al.*, 1993; Hall *et al.*, 1994). A diagnosis and possible association with reactivated infection is difficult to establish because of the presence of antibodies resulting from the primary infection. However, as viraemia can accompany reactivation, diagnosis by quantitative PCR is possible; preliminary evidence supports this (Clark *et al.*, 1997; Kasolo *et al.*, 1997). Antibody avidity tests have also been proposed to distinguish IgM from the primary infection from higher affinity IgG raised during secondary infections (Ward *et al.*, 1993b). Factors influencing virus reactivations include immunosuppression and infection with other agents such as measles (Suga *et al.*, 1992), other herpesviruses (Linde *et al.*, 1990) or infections with different strains of HHV-6 or HHV-7 (Katsafanas *et al.*, 1996). Some of these multiple infections and virus reactivations have been associated with fatalities. In a Beijing study, HHV-6 aetiology accounted for 2% of acute childhood en-

cephalitis (age 7 months to 13 years), about the same proportion as found for HSV. This accounted for 7% of all encephalitis linked to viral aetiology (Xu *et al.*, 1996).

Secondary Reactivated Infections in Adults

Since primary infection in children is widespread, there is considerable interest in the pathology associated with reactivated infections in adults. Immunosuppressed patient populations are primary targets but reactivation has also been observed in apparently 'normal' hosts. In asymptomatic adults, 0 to 10^3 HHV-6 genome equivalents per 10^6 PBMC have been observed, which is lower than in viraemic primary infections during childhood (see above), whereas HHV-6 is not detected in cell-free plasma during latency. Both primary infections in children and virus reactivation in immunosuppressed adults are accompanied by viraemia, which can lead to detection of virus DNA in the plasma (Secchiero *et al.*, 1995).

Bone Marrow Transplant Patients

In transplant patients receiving immunosuppressive therapy, HHV-6 reactivation has been documented as one of the first human herpesviruses to reactivate, before HCMV and EBV infections (Wang *et al.*, 1996). This can be asymptomatic or accompanied by rash and fever with general malaise, sinusitis and association with HCMV infections (Kadokia *et al.*, 1996). In bone marrow transplant patients there is also evidence that virus reactivation, either from the donor or the host, can result in virus replication in the bone marrow, associated with suppression of outgrowth of particular progenitor cells. In one study this was a general effect; in others delayed engraftment was observed for granulocytes, platelets or red cells (Drobyski *et al.*, 1993; Kadokia *et al.*, 1996; Wang *et al.*, 1996). An association with increased graft-versus-host disease has been reported (Wilborn *et al.*, 1994a; Appleton *et al.*, 1995) but not confirmed by others (Kadokia *et al.*, 1996; Wang *et al.*, 1996). The bone marrow suppression observed in the transplant patients has also been observed in an apparently 'normal' adult who also had both HHV-6 and legionella-asso-

ciated pneumonia plus HHV-6 replication in the bone marrow (Gompels *et al.*, 1994). *In vitro* studies also support a role for HHV-6 in bone marrow suppression where the virus inhibits the outgrowth of progenitor cells, including granulocyte/macrophage and erythroid lineages, while HHV-7 had no effect (Isomura *et al.*, 1997). In one study where both HHV-6 and HHV-7 were assayed, only HHV-6 reactivation was associated with bone marrow suppression (Wang *et al.*, 1996). However, in a separate study, HHV-7 was associated with a longer time for neutrophil engraftment and with symptomatic HCMV disease (Chan *et al.*, 1997).

Other Transplant Patients

HHV-6 infection, reactivation or reinfection has been observed in liver and kidney transplant patients. Clinical manifestations were observed in those with concomitant HCMV infection (Herbein *et al.*, 1996; Ratnamohan *et al.*, 1998). In one liver transplant patient, a rare adult primary infection with HHV-6 was accompanied by fever and fits (Ward *et al.*, 1989). In four other liver transplant patients studied, HHV-6 reactivation was associated with bone marrow suppression as well as, in one case, with pneumonitis (Singh *et al.*, 1997). Studies of the reactivation of HHV-6 together with HCMV after liver transplantation have shown that HHV-6 is a marker for symptomatic HCMV infection (Dockrell *et al.*, 1997). Similar effects have been suggested for HHV-7 reactivation in relation to HCMV disease in renal allograft patients (Osman *et al.*, 1996). It is not clear whether this is a result of direct interactions, the immunosuppressive effects of HHV-6 or HHV-7 favouring HCMV reactivation, or other factors, including similar immunological conditions in patients with dual reactivations.

Pneumonitis

HHV-6 infections have been associated with pneumonia, particularly in immunosuppressed patient groups, but whether this is a direct effect is not clear (Carrigan *et al.*, 1991; Cone *et al.*, 1993a, 1996; Gompels *et al.*, 1994). In some cases this has led to fatalities (Knox *et al.*, 1995b).

Associations with Neurological Conditions

All human herpesviruses have been detected in the

CNS, but the specificity of this interaction differs; only the alphaherpesviruses, HSV and *Varicella zoster virus* (VZV), have a demonstrable site of latency within neuronal tissue. HHV-6 and HHV-7 infections have been associated with neurological conditions but the mechanism for this has not yet been established. HHV-6 DNA has been detected in the CNS within brain autopsy tissue of normal and patient groups and has been suggested as a commensal of the brain. Whether this is a lytic, latent or carrier effect has not been established (Challoner *et al.*, 1995; Merelli *et al.*, 1997).

The association of HHV-6 with neurological conditions has been suggested, often on the basis of identification of virus DNA within the cerebrospinal fluid (CSF) of different groups of patients. HHV-6 DNA has been detected in the CSF of patients with recurrent seizures/fits (Kondo *et al.*, 1993). In patients with CNS disease HHV-6 DNA has also been identified in CSF (Wilborn *et al.*, 1994; Cinque *et al.*, 1996). Acute encephalitis, meningoencephalitis and demyelinating encephalitis have been attributed to HHV-6 in some cases via identification of virus DNA in CSF, as well as DNA and antigen in local white matter lesions of autopsy samples (Moschetti *et al.*, 1996; Kamei *et al.*, 1997; Novoa *et al.*, 1997). Further association with meningoencephalitis with basal ganglia infarction was demonstrated by serology showing acute infection (Webb *et al.*, 1997). Fatal cases of HHV-6-associated encephalitis have been shown in patients with immune disorders, such as AIDS, bone marrow transplant and a multiple sclerosis (MS) patient (Asano *et al.*, 1992; Drobyski *et al.*, 1994; Merelli *et al.*, 1996), but also in an immunocompetent adult (Novoa *et al.*, 1997). HHV-7 has also been associated with neurological conditions but further analyses have not been done (Torigoe *et al.*, 1996; Clark *et al.*, 1997).

HHV-6 has also been recently associated with MS by antibody and CSF studies, but a clear relationship remains to be established. Analyses are complicated by the widespread nature of this virus infection and frequent detection of virus DNA in normal brain autopsy material. However, the preliminary data does point to a possibly interesting correlation, but further work is required to determine whether this is a cause or effect of MS or merely a fortuitous association of HHV-6 latently carried in an MS-associated cell type. If HHV-6 can cause MS, with such a widespread persistent virus

infection, why MS occurs in some groups and not others needs to be explained. Perhaps the question of HHV-6 and its relationship to AIDS is similar. Thus HHV-6 can be immunosuppressive and can destroy helper T lymphocytes; why pathology in some patients and not in others? Is it local viral load from new infections or virus reactivations from latency; are host factors involved or is it a combination of different factors?

Abnormal expression of a viral antigen, pp41 (U27), has been demonstrated in association with MS plaques, in oligodendrocyte-like cells (Challoner *et al.*, 1995). In the same study, DNA was detected in CSF of some MS patients. Similarly, an earlier study detected HHV-6 DNA in the CSF of 3/21 MS patients but not in matched sera, while no virus DNA was detected in other neurological disease or control groups (Wilborn *et al.*, 1994b). However, this has not been confirmed in a wider study of 115 MS patients where HHV-6 DNA was not detected in the CSF or serum (Martin *et al.*, 1997). These recent results do not support a role for disseminated infection in MS, although they do not rule out the important possibility of associations with local lesions (as suggested in the Challoner study and the encephalitis reports), and this requires further evaluation.

Increased antibody levels have been observed in two studies of MS patients (Wilborn *et al.*, 1994b; Soldan *et al.*, 1997). Where MS patient groups have been further subdivided, an increased IgM response to HHV-6 pp41/38 antigen was shown in a subgroup of patients, relapsing-remitting MS (RRMS), versus those with chronic progressive MS (CPMS) or other neurologic disease, autoimmune disease and normal controls (Soldan *et al.*, 1997). In this latter study, viral DNA was also detected in some of the patients' sera and this was used as a marker for viraemia (Secchiero *et al.*, 1995; Soldan *et al.*, 1997). However serum DNA has not been consistently observed in other studies including both HHV-6 and HHV-7 (Wilborn *et al.*, 1994b; Martin *et al.*, 1997).

Evaluation as an Immunosuppressive Agent

There is evidence from *in vitro* studies and some *in vivo* observations to suggest that both HHV-6 and

HHV-7 can act as immunosuppressive agents. *In vitro* both viruses infect and kill T lymphocytes by both direct cell lysis mediated by cell fusion and by apoptotic mechanisms. Other immune cells can be infected and compromised, as demonstrated by HHV-6 *in vitro* infections of B-lymphocytes, natural killer cells and monocytic/macrophage cells (see below). HHV-7 infections appear to have a more restricted cellular tropism, probably due to their requirement for CD4 antigen as a receptor on the cell surface (Lusso *et al.*, 1994). *In vivo* infection is associated with leucopenia during primary infection as well as hypocellularity in lymph nodes in AIDS patients. HHV-6 replication within the bone marrow has been observed and this has been associated with bone marrow suppression. Unlike HIV, life-long immunity to these viruses is generated, which can be compromised in certain situations, leading to disease. Reactivation of HHV-6 and HHV-7 could lead to further immunosuppression, which could underlie or enhance other infections such as HIV/AIDS or pneumonitis; there is some evidence to support this.

Evaluation as an Oncogenic Agent

One region of HHV-6, ORF 1 in a restriction enzyme DNA fragment ('Sal L'), has been shown to have the ability to morphologically transform 3T3 cells and that these cells injected into nude mice can develop tumours (Thompson *et al.*, 1994). This gene product of gene DR7 also has the ability to transactivate the HIV promoter (see below), so appears to function normally in gene regulation. Recent studies have shown that it can bind the antioncogene P53, which may contribute to its *in vitro* properties of cellular transformation (Kashanchi *et al.*, 1997). A tumour suppressor activity has been defined and cell lines established which express this property in inhibiting H-Ras and BPV-1 transformation via downregulation of their promoters for gene expression (Araujo *et al.*, 1997). *In vivo* there is some evidence for associations with some lymphoproliferative disorders, but these seem rare events. For example, an EBV-negative but HHV-6-positive Burkitt lymphoma cell line has been described, as well as isolated cases of HHV-6-associated rare small T cell lymphoma (Braun *et al.*, 1995; Bando-bashi *et al.*, 1997). Early associations with Hodg-

kin's disease may be an indirect effect or possibly carrier effect, in that, although integrated HHV-6 has been observed in cells derived from Hodgkin's lymphoma, there is no evidence for HHV-6 DNA or gene expression within the Reed-Sternberg cells (Valente *et al.*, 1996). There is no evidence to date for cellular transformation by HHV-7 or association with abnormal cellular proliferations, although a homologue encoded by the DR7 gene has been identified (Nicholas, 1996).

Diagnosis

Infection with HHV-6 can be diagnosed by indirect immunofluorescence, virus isolation, PCR, reverse transcriptase (RT)-PCR, ELISA capture assays and virus neutralization assays. By electron microscopy (EM) the virus has the classic herpesvirus nucleocapsid morphology, with irregular envelopment including tegument proteins and a lipid bilayer membrane containing surface projections composed of glycoproteins. EM is not sufficient to diagnose HHV-6 or HHV-7 from other herpesviruses. Indirect immunofluorescence using acetone-fixed whole infected cells in reaction with human sera and fluorescein isothiocyanate (FITC) conjugates is the main diagnostic tool. This is generally a sensitive assay but will not distinguish between HHV-6 strains or primary versus reactivated infections. In addition, there is a large level of cross-reaction between HHV-6- and HHV-7-positive sera. Some assays incorporate cross-blocking steps for both these viruses and claim specificity; others incorporate specific PCR-based assays (Black *et al.*, 1996c; Tanaka-Taya *et al.*, 1996; Clark *et al.*, 1997). There are some antigens which can also cross-react with certain conserved proteins in HCMV, but these are rare.

HHV-6 and HHV-7 serologies are not sufficient to detect virus reactivation and associated pathology. Different assays have been used to distinguish primary versus reactivated infections, including (gG avidity assays, levels of blood DNA, differential detection of DNA in the blood versus saliva (Ward *et al.*, 1993b; Clark *et al.*, 1997). Primers for sensitive DNA PCR or cDNA RT-PCR have been described and, when used in conjunction with quantitative PCR, can be used to determine if an infection is viraemic. These methods are under evaluation. In

latently infected adults the level of circulating cells harbouring latent HHV-6 or HHV-7 DNA have been estimated to be as little as 1 in 10^5 or 10^6 , but during a viraemia levels can be between 10^5 and 10^{11} times higher (Cone *et al.*, 1993b; Clark *et al.*, 1997; Kasolo *et al.*, 1997). Consequently, HHV-6 virus isolation from the blood is usually only observed if there are high levels of circulating, actively replicating virus. However, HHV-7 was first isolated from an apparently healthy individual (Frenkel *et al.*, 1990b). There appears to be higher levels of HHV-7 circulating than HHV-6 (Cone *et al.*, 1993b; Kidd *et al.*, 1996; Clark *et al.*, 1997). In exanthem subitum infants, DNA is detected in acute and convalescent stages but not before onset of HHV-6 or HHV-7 disease (Tanaka-Taya *et al.*, 1996).

Specific tests for antigens which correlate with active infections or virus reactivation are being developed. In HHV-6, a 100 kDa phosphoprotein, p100 or p101 encoded by U11, is present in the tegument and has been identified as one of the immunodominant targets for antibody responses (Neipel *et al.*, 1992; Pellett *et al.*, 1993). In HHV-7, proteins with similar immunogenicity, but lower molecular weight, 85–88 kDa have been described and specific antibody reagents defined. The target for the 85 kDa protein is distinct, the HHV-7 U14 tegument protein (Black *et al.*, 1996b; Foa-Tomasi *et al.*, 1996; Stefan *et al.*, 1997). Antigenicity and antibody reagents to late glycoproteins which are markers for infection have also been characterized, glycoproteins gB and gH (U39 and U48), and these are targets for protective humoral immunity (CampadelliFiume *et al.*, 1993; Ellinger *et al.*, 1993; Liu *et al.*, 1993, 1993b). None of these markers have 100% specificity.

RELATIONSHIPS TO HIV/AIDS

Both HHV-6 and HHV-7 share cellular targets with HIV. These viruses can infect and kill CD4 + T lymphocytes. HHV-6, like HIV, can also infect and remain latent within monocytic/macrophage cells. This may also be demonstrated for HHV-7. Both HIV and HHV-7 use CD4 as a cellular receptor. HIV additionally uses as a coreceptor members of the chemokine family of receptors. It is not known whether HHV-6 or HHV-7 also use these corecep-

tors for entry but chemokines which inhibit HIV entry do not inhibit HHV-6 entry (Cocchi *et al.*, 1995). Interestingly both HHV-6 and HHV-7 encode proteins with features of G-protein-coupled receptors which have similarity to chemokine receptors, and infection with these viruses can up-regulate expression of a chemokine receptor, CCR7 (Gompels *et al.*, 1995; Nicholas, 1996; Yoshida *et al.*, 1997). Unlike HIV, both HHV-6 and HHV-7 can initially infect and persist in epithelial cells and specialized sites such as salivary gland epithelium. Expression of one of the HHV-6 chemokine receptor-like genes U51 in epithelial cells results in down-regulation and secretion of selected chemokines which can inhibit HIV infection (R. Milne and U.A. Gompels, unpublished results).

Reactivated Infections in HIV/AIDS Patients

In AIDS patients human herpesviruses reactivate and cause major viral opportunistic infections leading to both morbidity and mortality. The contributions by HHV-6 and HHV-7 to these infections, either singly or in combination with other herpesviruses or other infections, are being evaluated. Both viruses can lead to disseminated infections and there is evidence for fatalities associated with HHV-6 reactivations. The big question is whether HHV-6 and HHV-7 also synergize with HIV in progression to AIDS.

Disseminated Infections

Both childhood and adult AIDS patients show evidence for disseminated HHV-6 infections. The virus appears to be one of the first herpesviruses to reactivate in HIV patients. By PCR the HHV-6 can be detected at multiple sites with increased viral load (Corbellino *et al.*, 1993; Knox and Carrigan, 1994; Clark *et al.*, 1996). There may be a complicated relationship with HIV, because HHV-6 and HHV-7 can reactivate each other (Katsafanas *et al.*, 1996). Studies of viral load detected by DNA PCR in saliva show increased secretion of HHV-7 in HIV/AIDS patients (DiLuca *et al.*, 1995). These infections are difficult to monitor at the periphery in blood since the level of the target cell for both HHV-6 and HHV-7, the CD4 + cell, becomes very

much reduced in patients with late stage AIDS, which also results in the depletion of the target cell for HHV-6 and HHV-7. As detected by DNA PCR, levels of HHV-6 and HHV-7 decrease in PBMC in late stage AIDS patients (Fairfax *et al.*, 1994; Fabio *et al.*, 1997). In contrast, in disseminated infection the level increases in other tissues (Emery *et al.*, 1999) and virus can be detected in plasma, which is a marker for viraemia and virus reactivation (Secchiero *et al.*, 1995). In a longitudinal study of HHV-6 reactivation in two HIV-1 infected patients, the CD4 + cell count decreased coincident with HHV-6 reactivation and in both cases involved variant A; one of the patients secreted both A and B variant strains (Iuliano *et al.*, 1997). Whether HHV-6 and HHV-7 directly contribute with HIV to the depletion of the T lymphocytes in the blood is not known.

Retinitis

HHV-6 has been detected *in vivo* in AIDS retinitis. Usually it is detected in coinfections with HCMV, but it has also been identified on its own. HHV-6 and HCMV coinfections may affect their pathologies and interacting effects have been shown *in vitro* (Fillet *et al.*, 1996). HHV-6 has been shown *in vitro* to infect retinal epithelium.

Complications, Lymphadenopathy, Pneumonitis, Encephalitis

Although the total contribution remains to be determined, isolated accounts show that HHV-6 reactivations in AIDS patients can be associated with fatalities due to pneumonitis and encephalitis (Knox and Carrigan, 1994; Knox *et al.*, 1995b). HHV-6 reactivations have been associated in HIV-infected individuals with early phase lymphadenopathy syndrome but not with malignant lymphoproliferations (Dolcetti *et al.*, 1996). HHV-6 can be detected in brain biopsies from deceased AIDS patients, where the CNS infections were similar to HHV-6-associated neuropathology in a bone marrow transplant patient with fatal encephalitis. In addition, fulminant HHV-6-associated encephalitis has been detected in an HIV-infected infant (Knox and Carrigan, 1995; Knox *et al.*, 1995a).

Multiple Herpesvirus Infections

The picture is complex. Thus AIDS patients show

infections/reactivations with multiple herpesviruses, but also with multiple strains. For example, the first isolate in USA of HHV-6 was in an AIDS patient and was one of the A variant strains which are rare in that country. Multiple A and B strains have been found in HIV/AIDS patients (Iuliano *et al.*, 1997).

Treatment for multiple herpesvirus infections in AIDS patients has been put forward as a strategy for management of opportunistic infections which may affect AIDS progression and survival (Whitley, 1997).

Direct Interactions

There can be both direct and indirect interactions between HHV-6 and HHV-7 with HIV. Indirect interactions include those described above, in which the viruses may reactivate during periods of immunosuppression in AIDS patients. The viruses may also have direct interactions with HIV by enhancing replication or interrupting latency of HIV. By these actions HHV-6 and HHV-7 could contribute to AIDS progression in those infected with HIV.

Relationship to CD4 Cell Count

Both HHV-6 and HHV-7 are markers for AIDS progression. The levels of DNA quantitated in PBMC of AIDS patients are inversely correlated with the CD4 + T lymphocyte cell count (Fairfax *et al.*, 1994; Fabio *et al.*, 1997). Thus as the 'CD4' count decreases, the levels of detectable HHV-6 and HHV-7 also decrease. However, this is also at a time where the whole body load of the virus increases due to disseminated infections. The simple interpretation of this data is that depletion of CD4 cells by HIV infection results in fewer cells for reactivated HHV-6 and HHV-7 replication. The more complex interpretation is that reactivation of all these viruses have contributed to the CD4 depletion. Both HHV-6 and HHV-7 can contribute to this depletion by direct cell lysis. HHV-7 can also contribute by downregulation of the CD4 antigen.

Transactivation of HIV Genes and Reactivation HIV Latency

HHV-6 encodes several genes which regulate gene

expression. Their role in the normal virus life cycle is to regulate the cascade of gene expression from immediate-early to early to late genes. They also may have roles in regulating cellular gene expression to enhance virus production and in roles for establishing, maintaining or reactivating latency. Some of these genes can also transactivate the HIV promoter. This has been shown *in vitro* using reporter gene assays for HHV-6 proteins encoded by DR7, U16, U27, U89 and U94, as reviewed previously (Gompels *et al.*, 1995). It has also been shown *in vivo*, whereby HHV-6 gene expression (DR7) has been shown to reactivate a *tat*-deficient HIV provirus from latency (Gompels *et al.*, 1995; Kashanchi *et al.*, 1994, 1997). The DR7 homologue exists in HHV-7 but its function has not been compared to HHV-6 DR7.

Lymph Node Infections

HHV-6 has been identified along with HIV in lymph node biopsies of AIDS patients. Here, using antigen-specific markers, HHV-6 replication has been demonstrated in regions of hypocellularity. It has been suggested that HHV-6 reactivation at these sites is associated with cell damage in the lymph nodes and *in vitro* studies show the virus can reactivate HIV from latency in monocytes (Knox and Carrigan, 1996). These infections were identified as A variant strains; whether this is specific to this group requires further investigation.

Coinfections Suppression/Activation, Induction/Repression CD4

In coinfection studies of HHV-6 or HHV-7 with HIV, different effects have been observed. HHV-6 has been observed to increase or decrease HIV infection during *in vitro* double infections (Lusso *et al.*, 1989; Carrigan *et al.*, 1990; Levy *et al.*, 1990). Some of these differences could be strain differences; other possibilities are different cellular systems, use of cell associated or cell-free virus stocks, or differences in multiplicity of infection. It is possible that *in vivo*, depending on the cell type, there will be both effects. For example, HHV-6 can upregulate CD4 antigen expression abnormally in cells not normally expressing this cell surface marker (Lusso *et al.*, 1991a, 1993, 1995). This action now renders these cells susceptible to infection by HIV, for example NK cells, and can enhance spread of HIV

infection and cell types infected. Alternatively, HHV-6 can kill the CD4 + T lymphocytes, reduce the target cell population susceptible to HIV infection and contribute to selective pressure on HIV towards wider host ranges. Other receptors may be involved in these interactions, in that HHV-6 infection of progenitor cell lines renders these cells susceptible to HIV infection (Furlini *et al.*, 1996).

Since HHV-7 downregulates CD4 expression, this virus may interfere with HIV infections at an early stage. Such inhibitory effects have been observed in cell culture (Crowley *et al.*, 1996). Multiple levels of control of CD4 expression have been shown which affect RNA and protein production as well as cell surface expression; these activities are independent of p56lck levels (Furukawa *et al.*, 1994; Secchiero *et al.*, 1997b).

IMMUNE REACTION

Infection by HHV-6 or HHV-7 can lead to lifelong protective immunity; however, this may be largely dependent on the initial severity of the primary infection and the specific responses generated. Asymptomatic reactivations have been recorded, as well as asymptomatic re-infections with multiple strains. Infection with HHV-6 does not appear to protect against infection with HHV-7, but it is possible, as it is with other related herpesviruses, that cross-reactive epitopes in some of the conserved proteins do generate cross-protective responses that may reduce the severity of infections.

Antigenic Targets

In order to study antigenic targets, antibody reagents have been raised against both HHV-6 and HHV-7. Tests with human sera have identified a number of proteins, mostly by Western blot (Chandran *et al.*, 1992). Monoclonal antibodies have been used to identify a number of proteins. Some of these antigenic targets correspond to those identified in reactions with human sera. One of these is the p100 protein, HHV-6 U11, shown in both A and B strains of HHV-6 (Neipel *et al.*, 1992). One reagent is B strain specific and has been used for *in situ* immunocytochemistry to identify replicating virus (Pellett *et al.*, 1993). The p100 protein is a large tegu-

ment antigen which is an abundant structural protein. Interpretation of these data may be confounded, since the antigen may also be present in phagocytosed cells or virions. Consequently, positive results may not represent regions of virus replication but rather antigenaemia, as shown for HCMV and the p150 protein homologue (Chapter 2C). The p100 antigen does, however, appear to be useful diagnostically as it is one of the immunodominant proteins. Strain-specific antibodies to glycoproteins gH and gB have been identified; these are neutralizing antibodies, which suggests that *in vivo* some antigenic variation may affect immunological recognition (CampadelliFiume *et al.*, 1993; Takeda *et al.*, 1997). Similar results have been reported for strain variants of HCMV (Chapter 2C). In HHV-7, potential immunodominant targets have been identified (Stefan *et al.*, 1997). One has been identified as the p85 tegument protein encoded by HHV-7 ORF 14 (Stefan *et al.*, 1997). Again, as these are abundant structural proteins their presence in tissues may represent either viral replication or phagocytic events (Kempf *et al.*, 1997). Cellular targets have not been specified, although a number of HHV-6 or HHV-7-specific T cell clones have been described, some of which are cross-reactive between HHV-6 and HHV-7, with a minority also cross-reactive with HCMV (see above) (Yasukawa *et al.*, 1993).

Immunity

Both humoral and cellular immunity have been described for HHV-6; less is known for HHV-7.

Neutralizing Antibodies

Neutralizing antibodies are generated to both viruses after primary infections. Some of the antigens for this response have been defined and they include the conserved glycoproteins gB(U39), neutralizing with complement (FoaTomasi *et al.*, 1992) and the gH/gL complex (U48/U82), neutralizing in the absence of complement (Liu *et al.*, 1993a). In HHV-6 there is a multiple spliced glycoprotein gp 82/105, HHV-6 U100, and this is also a target for neutralizing antibodies. A homologue to this protein exists only in HHV-7 and not in other herpesviruses (Pfeiffer *et al.*, 1993). Monoclonal antibody reagents

have been generated to both of these viruses and some of these have been developed into diagnostic assay systems (Balachandran *et al.*, 1989; FoaTomasi *et al.*, 1991; Okuno *et al.*, 1992; CampadelliFiume *et al.*, 1993; Liu *et al.*, 1993a; Pfeiffer *et al.*, 1993; FoaTomasi *et al.*, 1995, 1996; Nakagawa *et al.*, 1997). As with other human herpesviruses, many of the antibody responses generated are not relevant to a protective response but are useful diagnostically. Thus, a high antibody titre does not necessarily correspond to a high protective antibody response.

Cell-mediated Response

Cellular immunity has been demonstrated to both HHV-6 and HHV-7. The responses to HHV-6 and HHV-7 are largely specific, although some reactions show cross-reactivity, as would be predicted from sequence comparisons (Yasukawa *et al.*, 1993). Specific clones have been generated from both CD4 + T lymphocytes and NK cells (Lusso *et al.*, 1993; Yasukawa *et al.*, 1993). Although HHV-6 and HHV-7 have the capacity to kill T lymphocytes, they can also generate a normal antiviral response, given antigen presentation to these cells.

Immunosuppression

Aside from direct cellular lysis of permissive T lymphocytes, HHV-6 and HHV-7 can also have effects which perturb the function of immune cells. The killing of T lymphocytes can also be mediated by T cell apoptosis in a bystander effect induced by HHV-6 infected cells (Inoue *et al.*, 1997; Secchiero *et al.*, 1997a). Direct virus effects on cellular proteins may also affect functions of immune cells. As mentioned above, HHV-6 and HHV-7 can affect surface expression of CD3 and CD4 antigens, thus affecting immune activation and signal transduction. HHV-6 downregulates CD3 and HHV-7 downregulates CD4 (Lusso *et al.*, 1991b; Secchiero *et al.*, 1997b; Furukawa *et al.*, 1994). Multiple mechanisms involving both transcriptional and postranscriptional events appear to be involved. HHV-6 can upregulate CD4 on a number of cell types, including NK and γ/δ T cells (Lusso *et al.*, 1991a, 1993, 1995). This can affect the function of these cells, giving rise to abnormal signalling, and may reflect wider activa-

tion of the cells types. Interestingly, where CD4 expression is introduced in bone marrow progenitor cells these are rendered sensitive to infection with HHV-7. There may therefore be a number of synergistic effects between these viruses (Yasukawa *et al.*, 1997).

A number of cytokines are abnormally regulated in HHV-6 infected cells. These include downregulation of interleukin (IL)-2 synthesis, leading to suppression of cellular proliferation (Flamand *et al.*, 1995). HHV-6 can inhibit the proliferative responses of PBMC (Horvat *et al.*, 1993) whereas, IL-2 can inhibit HHV-6 replication (Roffman and Frenkel, 1990). Other cytokines are upregulated by HHV-6 infection, including IL-10, IL-12, tumour necrosis factor α (TNF α) and IL-1B (Flamand *et al.*, 1991; Li *et al.*, 1997). Downregulation of the chemokine RANTES has been observed as a gene-specific event in dermal epithelial cells (R. Milne and U.A. Gompels, unpublished results), whereas IL-8 is upregulated in hepatic epithelial cells (Inagi *et al.*, 1996). HHV-6 can enhance NK cell activity through IL-15, where it also has upregulated CD4 (Flamand *et al.*, 1996). HHV-6 virus infection can also upregulate TNF κ B receptors and chemokine receptors, EB1 or CCR7, which can further influence signalling in different cell types (Hasegawa *et al.*, 1994; Yoshida *et al.*, 1997). Interestingly, the ligand for CCR7, ELC, is most strongly expressed in thymus and lymph nodes where these viruses can replicate (Hoshida *et al.*, 1997).

HHV-6 infection has been shown *in vitro* to be associated with dysfunction of monocytes, as well as suppression of macrophage maturation in human bone marrow cultures (Burd and Carrigan, 1993; Burd *et al.*, 1993). HHV-6 also has been shown to suppress *in vitro* cell differentiation and colony formation of haematopoietic progenitor cells (Knox and Carrigan, 1992; Isomura *et al.*, 1997). These findings correlate with some of the *in vivo* findings of HHV-6-associated bone marrow suppression.

Immune Evasion

The viruses can indirectly achieve immune evasion by perturbing the function of immune effector cells, as described above. Other direct effects are possible by gene products which mimic actions of immune regulatory molecules. These can have actions of

either enhancing infection or avoiding protective immunity. It is likely that both principles apply, in that these viruses need to maintain a delicate balance with the immune system, such that there is sufficient immunity for host survival but not too much, so ensuring virus persistence. Latency is the classic approach used by herpesviruses to evade immunological detection. In HHV-6 latency there is evidence that there is limited antigen expression (U94) (Rotola *et al.*, 1998) with genome survival in both monocytic/macrophage and bone marrow progenitor cell types (Kondon *et al.*, 1991; Gompels *et al.*, 1994). Both viruses also encode a number of proteins which may affect immune recognition or activation. These include members of the immunoglobulin, chemokine receptor and chemokine protein families (Gompels *et al.*, 1995; Nicholas, 1996; Isegawa *et al.*, 1998). The HHV-6 U51 product, with chemokine receptor features, has been shown to mediate some signalling events in the cell, and in epithelial cells can downregulate RANTES expression in the absence of any effect on IL-8 (R. Milne and U.A. Gompels, unpublished results).

THERAPY

There are a number of classic antiviral chemotherapeutic agents which have been evaluated against HHV-6 and HHV-7, as well as new approaches to therapy. However, there is no routinely used treatment for serious complications by these virus infections. Both viruses are also being evaluated as possible vectors for gene therapy, given their cellular tropisms and theoretically large DNA packaging capacities.

Antiviral Drug Sensitivity

Given the genetic similarities between HHV-6 and HHV-7 with HCMV, many compounds active against HCMV may be expected to have similar effects on replication of HHV-6 and HHV-7. In general this has been demonstrated *in vitro*. Ganciclovir (GCV) and related derivatives are effective inhibitors of HHV-6 and HHV-7 replication (Reymen *et al.*, 1995; Takahashi *et al.*, 1997). Both viruses encode homologues of proteins in HCMV which are targets for these agents' activity and sites

for drug-resistant mutants. These are the homologues of the HCMV phosphotransferase, UL97, required for the phosphorylation of GCV, U69 in HHV-6 and HHV-7, as well as the virus-encoded DNA polymerase, HHV-6 and HHV-7 U38 (Gompels *et al.*, 1995; Nicholas, 1996). Also active against these viruses are acyclic nucleoside phosphonate analogues such as cidofovir (HMPC) (Takahashi *et al.*, 1997). As HHV-6 and HHV-7 can both also have immunosuppressive actions, side-effects from GCV may complicate outcomes on patients where the viruses have reactivated due to immunodeficiency, either from AIDS or therapy given to transplanted patients.

Drugs which require thymidine kinase (TK) for activity are ineffective *in vitro*. This includes acyclovir (ACV), brivudin (BVDU), and scivudine (BVaraU) (Reymen *et al.*, 1995; Takahashi *et al.*, 1997). Like HCMV, this is consistent with the observation that neither virus encodes the viral target for utilization of the drug, TK (Gompels *et al.*, 1995; Nicholas, 1996). However, there is some evidence from *in vivo* studies on HHV-6-associated inhibition of engraftment in bone marrow transplant patients, that high dose acyclovir may have some therapeutic value, although the mechanism of action is unknown (Wang *et al.*, 1996).

Direct inhibitors of the virus DNA polymerase, such as foscarnet (phosphonoformic acid, PFA) or phosphonoacetic acid (PAA) and related compounds, have also been shown to be effective against these viruses *in vitro* (Reymen *et al.*, 1995; Takahashi *et al.*, 1997). As with treatment for other herpesviruses, indiscriminate use of these drugs could give rise to drug-resistant mutants. These have not been characterized for HHV-6 or HHV-7 as yet.

New Targets for Antiviral Therapy

New targets for antiviral therapy are being evaluated. Screening with existing drug compounds has shown other possible drugs with some activities, but the targets are unknown (Reymen *et al.*, 1995; Takahashi *et al.*, 1997). Directed approaches have used candidate proteins identified in sequencing studies as new targets for an antiviral strategy. One of these is the viral protease. Cleavage of the full-length protease and an in-frame encoded scaffold-

ing protein have been shown in other herpesviruses to be essential for virus production (Tigue *et al.*, 1996). Characterization of the cleavage specificity has been a goal in order to design a drug which could inhibit this interaction. This has been aided by recent determination of the tertiary structure by crystallization studies of homologues in alpha- and betaherpesviruses (Chapter 2D). Both HHV-6 and HHV-7 encode homologues of this protease, U53 (Gompels *et al.*, 1995; Nicholas, 1996; Tigue *et al.*, 1996; C. Parry and U.A. Gompels, unpublished results). Cleavage specificity of the HHV-6-encoded protease has been investigated by using substrates from synthetic peptides (Tigue *et al.*, 1996) or site-directed mutagenesis on the full-length product produced *in vitro* and *in vivo* (C. Parry and U.A. Gompels, unpublished results).

In other herpesviruses an additional target has also been investigated using the similar strategy of characterizing protein-protein interactions in order to design an inhibitor. This is the ribonucleotide reductase which has homologues in human herpesviruses studied. In the alpha- and gammaherpesviruses, homologues of two subunits for this enzyme are found. It has been shown that peptide or peptide analogues can inhibit the association of the two subunits and are effective antivirals *in vitro* (Chapter 2A). However, in the betaherpesviruses including HCMV, HHV-6 and HHV-7, only homologues of the larger subunit are encoded in the respective genomic sequences, thus a similar antiviral strategy based on inhibiting the association of ribonucleotide reductase subunits appears unlikely (Gompels *et al.*, 1995).

Gene Therapy

HHV-6 and HHV-7 have *cis*-acting sequences in their genomes (non-coding regions which function intragenomically), which direct DNA replication, an 'origin', as well as sequences promoting DNA sequence cleavage and packaging into the viral nucleocapsid. It has been suggested that these sequences can be used to construct an artificially replicating vector which could be used to express foreign genes in gene expression/therapy studies (Dewhurst *et al.*, 1993; Gompels *et al.*, 1995; Megaw *et al.*, 1998). The telomeric repeats have also been considered for evaluation in expression constructs

because they may contribute to the specificity and efficiency of the DNA packaging signal. Additionally, they may have a special role during latent infections in maintenance of the genome, possibly as a linear chromosome. Such features may aid persistence of an artificial vector in gene therapy studies. *In vitro* replication assays have been performed to characterize the origin of replication and sequencing studies to determine the packaging signals (Dewhurst *et al.*, 1993; Gompels *et al.*, 1995).

Immune Therapy

A form of immune therapy may be possible with these infections. Inhibition of virus infection has been found by the exogenous addition of IL-2 (Roffman and Frenkel, 1990). In certain cases, however, treatment to activate cellular immunity may also activate the virus. For example, addition of some CD3 monoclonal antibodies can enhance infection, whereas others have no effect (Roffman and Frenkel, 1991). Humanized neutralizing monoclonal antibodies may be potential passive immune therapy for serious complications arising from primary paediatric infections. For example, it is still not known whether children born to mothers with AIDS have enhanced primary HHV-6 and HHV-7 infections due to lack of maternal immunity. In these patients, and others who do not have sufficient protection from maternal immunity, humanized neutralizing antibodies, for example to surface glycoproteins, may provide adequate therapy.

SUMMARY

In summary, HHV-6 and HHV-7 are widespread, but underdiagnosed. These T lymphotropic paediatric fever viruses form lifelong persistent or latent infections which may reactivate later to cause disease. They may be particular threats in some paediatric cases as well as in patient populations with immune suppression or disorders, such as transplant recipients or HIV/AIDS groups. There is also evidence for association with certain neurological conditions. These areas are under current evaluation.

REFERENCES

- Ablashi, D., Agut, H., Berneman, Z. *et al.* (1993) Human herpesvirus-6 strain groups: a nomenclature. *Archives in Virology*, **129**, 1–4.
- Anderson, R.A. and Gompels, U.A. (1999) N- and C-terminal external domains of human herpesvirus-6 glycoprotein H affect a fusion-associated conformation mediated by glycoprotein L binding the N terminus. *Journal of General Virology*, **80**, 1485–1494.
- Appleton, A.L., Sviland, L., Peiris, J. *et al.* (1995) Human herpesvirus-6 infection in marrow graft recipients: Role in pathogenesis of graft-versus-host disease. *Bone Marrow Transplantation*, **16**, 777–782.
- Araujo, J.C., Doniger, J., Stoppler, H. *et al.* (1997) Cell lines containing and expressing the human herpesvirus 6A ts gene are protected from both H-ras and BPV-1 transformation. *Oncogene*, **14**, 937–943.
- Asano, Y., Yoshikawa, T., Suga, S. *et al.* (1990) Fatal fulminant hepatitis in an infant with human herpesvirus-6 infection. *Lancet*, **335**, 862–863.
- Asano, Y., Nakashima, T., Yoshikawa, T. *et al.* (1991) Severity of human herpesvirus-6 viremia and clinical findings in infants with exanthem subitum. *Journal of Pediatrics*, **118**, 891–895.
- Asano, Y., Yoshikawa, T., Kajita, Y. *et al.* (1992) Fatal encephalitis/encephalopathy in primary human herpesvirus-6 infection. *Archives of Disease in Childhood*, **67**, 1484–1485.
- Asano, Y., Yoshikawa, T., Suga, S. *et al.* (1994) Clinical features of infants with primary human herpesvirus 6 infection (exanthem subitum, roseola infantum). *Pediatrics*, **93**, 104–108.
- Balachandran, N., Amelse, R.E., Zhou, W.W. *et al.* (1989) Identification of proteins specific for human herpesvirus 6-infected human T cells. *Journal of Virology*, **63**, 2835–2840.
- Bandobashi, K., Daibata, M., Kamioka, M. *et al.* (1997) Human herpesvirus 6 (HHV-6)-positive Burkitt's lymphoma: establishment of a novel cell line infected with HHV-6. *Blood*, **90**, 1200–1207.
- Black, J.B., Sanderlin, K.C., Goldsmith, C.S. *et al.* (1989) Growth properties of human herpesvirus-6 strain Z29. *Journal of Virological Methods*, **26**, 133–146.
- Black, J.B., Inoue, N., KitePowell, K. *et al.* (1993) Frequent isolation of human herpesvirus 7 from saliva. *Virus Research*, **29**, 91–98.
- Black, J.B., Durigon, E., KitePowell, K. *et al.* (1996a) Seroconversion to human herpesvirus 6 and human herpesvirus 7 among Brazilian children with clinical diagnoses of measles or rubella. *Clinical Infectious Diseases*, **23**, 1156–1158.
- Black J.B., Schwarz, T.F., Patton, J.L. *et al.* (1996b) Evaluation of immunoassays for detection of antibodies to human herpesvirus-7. *Clinical and Diagnostic Laboratory Immunology*, **3**, 79–83.
- Black, J.B., Schwarz, T.F., Patton, J.L. *et al.* (1996c) Evaluation of immunoassays for detection of antibodies to human herpesvirus 7. *Clinical and Diagnostic Laboratory Immunology*, **3**, 79–83.
- Braun, D.K., Pellett, P.E. and Hanson, C.A. (1995) Presence and expression of human herpesvirus 6 in peripheral blood mononuclear cells of S100-positive, T cell chronic lymphoproliferative disease. *Journal of Infectious Diseases*, **171**, 1351–1355.

- Burd, E.M. and Carrigan, D.R. (1993) Human herpesvirus 6 (HHV-6)-associated dysfunction of blood monocyte. *Virus Research*, **29**, 79–90.
- Burd, E.M., Knox, K.K. and Carrigan, D.R. (1993) Human herpesvirus-6-associated suppression of growth factor-induced macrophage maturation in human bone marrow cultures. *Blood*, **81**, 1645–1650.
- CampadelliFiume, G., Guerrini, S., Xiaoming, L. *et al.* (1993) Monoclonal antibodies to glycoprotein B differentiate human herpesvirus 6 into two clusters, variants A and B. *Journal of General Virology*, **74**, 2257–2262.
- Carrigan, D.R., Knox, K.K. and Tapper, M.A. (1990) Suppression of human immunodeficiency virus type 1 replication by human herpesvirus-6. *Journal of Infectious Diseases*, **162**, 844–851.
- Carrigan, D.R., Drobyski, W.R., Russler, S.K. *et al.* (1991) Interstitial pneumonitis associated with human herpesvirus-6 infection after marrow transplantation. *Lancet*, **338**, 147–149.
- Cermelli, C., Pietrosemoli, P., Meacci, M. *et al.* (1997) Supt-1: a cell system suitable for an efficient propagation of both HHV-7 and HHV-6 variants A and B. *Microbiologica*, **20**, 187–196.
- Challoner, P.B., Smith, K.T., Parker, J.D. *et al.* (1995) Plaque-associated expression of human herpesvirus 6 in multiple sclerosis. *Proceedings of the National Academy of Sciences of the USA*, **92**, 7440–7444.
- Chan, P.K.S., Peiris, J.S.M., Yuen, K.Y. *et al.* (1997) Human herpesvirus-6 and human herpesvirus-7 infections in bone marrow transplant recipients. *Journal of Medical Virology*, **53**, 295–305.
- Chandran, B., Tiratwatnapong, S., Pfeiffer, B. *et al.* (1992) Antigenic relationships among human herpesvirus-6 isolates. *Journal of Medical Virology*, **37**, 247–254.
- Cinque, P., Vago, L., Dahl, H. *et al.* (1996) Polymerase chain reaction on cerebrospinal fluid for diagnosis of virus-associated opportunistic diseases of the central nervous system in HIV-infected patients. *AIDS*, **10**, 951–958.
- Clark, D.A., Ait-Khaled, M., Wheeler, A.C. *et al.* (1996) Quantification of human herpesvirus 6 in immunocompetent persons and post-mortem tissues from AIDS patients by PCR. *Journal of General Virology*, **77**, 2271–2275.
- Clark, D.A., Kidd, I.M., Collingham, K.E. *et al.* (1997) Diagnosis of primary human herpesvirus 6 and 7 infections in febrile infants by polymerase chain reaction. *Archives of Disease in Childhood*, **77**, 42–45.
- Cocchi, F., DeVico, A.L., Garzino-Demo, A. *et al.* (1995) Identification of RANTES, MIP-1 alpha and MIP-1 beta as the major HIV-suppressive factors produced by CD8 + T cells. *Science*, **270**, 1811–1815.
- Cone, R.W., Hackman, R.C., Huang, M. *et al.* (1993a) Human herpesvirus 6 in lung tissue from patients with pneumonitis after bone marrow transplantation. *New England Journal of Medicine*, **329**, 156–161.
- Cone, R.W., Huang, M., Ashley, R. *et al.* (1993b) Human herpesvirus 6 DNA in peripheral blood cells and saliva from immunocompetent individuals. *Journal of Clinical Microbiology*, **31**, 1262–1267.
- Cone, R.W., Huang, M.L.W., Hackman, R.C. *et al.* (1996) Coinfection with human herpesvirus 6 variants A and B in lung tissue. *Journal of Clinical Microbiology*, **34**, 877–881.
- Corbellino, M., Lusso, P., Gallo, R.C. *et al.* (1993) Disseminated human herpesvirus 6 infection in AIDS (18). *Lancet*, **342**, 1242.
- Crowley, R.W., Secchiero, P., Zella, D. *et al.* (1996) Interference between human herpesvirus 7 and HIV-1 in mononuclear phagocytes. *Journal of Immunology*, **156**, 2004–2008.
- Dewhurst, S., Dollard, S.C., Pellett, P.E. *et al.* (1993) Identification of a lytic-phase origin of DNA replication in human herpesvirus 6B strain Z29. *Journal of Virology*, **67**, 7680–7683.
- DiLuca, D., Mirandola, P., Ragvaoli, T. *et al.* (1995) Human herpesviruses 6 and 7 in salivary glands and shedding in saliva of healthy and human immunodeficiency virus positive individuals. *Journal of Medical Virology*, **45**, 462–468.
- Dockrell, D.H., Prada, J., Jones, M.F. *et al.* (1997) Seroconversion to human herpesvirus 6 following liver transplantation is a marker of cytomegalovirus disease. *Journal of Infectious Disease*, **176**, 1135–1140.
- Dolcetti, R., Di Luca, D., Carbone, A. *et al.* (1996) Human herpesvirus 6 in human immunodeficiency virus-infected individuals: association with early histologic phases of lymphadenopathy syndrome but not with malignant lymphoproliferative disorders. *Journal of Medical Virology*, **48**, 344–353.
- Drobyski, W.R., Dunne, W.M., Burd, E.M. *et al.* (1993) Human herpesvirus-6 (HHV-6) infection in allogeneic bone marrow transplant recipients. I. Evidence of a marrow suppressive role for HHV-6 *in vivo*. *Journal of Infectious Diseases*, **167**, 735–739.
- Drobyski, W.R., Knox, K.K., Majewski, D. *et al.* (1994) Brief report: Fatal encephalitis due to variant B human herpesvirus-6 infection in a bone marrow-transplant recipient. *New England Journal of Medicine*, **330**, 1356–1360.
- Ellinger, K., Neipel, F., Foa-Tomasi, L. *et al.* (1993) The glycoprotein B homologue of human herpesvirus 6. *Journal of General Virology*, **74**, 495–500.
- Emery, V.C., Atkins, M.C., Bowen, E.F. *et al.* (1999) Interactions between beta-herpesviruses and human immunodeficiency virus *in vivo*: evidence for increased human immunodeficiency viral load in the presence of human herpesvirus 6. *Journal of Medical Virology*, **57**, 278–282.
- Enders, G., Biber, M., Meyer, G. *et al.* (1990) Prevalence of antibodies to human herpesvirus 6 in different age groups, in children with exanthema subitum, other acute exanthematous childhood diseases, Kawasaki syndrome, and acute infections with other herpesviruses and HIV. *Infection*, **18**, 12–15.
- Fabio, G., Knight, S.N., Kidd, I.M. *et al.* (1997) Prospective study of human herpesvirus 6, human herpesvirus 7, and cytomegalovirus infections in human immunodeficiency virus-positive patients. *Journal of Clinical Microbiology*, **35**, 2657–2659.
- Fairfax, M.R., Schacker, T., Cone, R.W. *et al.* (1994) Human herpesvirus 6 DNA in blood cells of human immunodeficiency virus-infected men: correlation of high levels with high CD4 cell counts. *Journal of Infectious Diseases*, **169**, 1342–1345.
- Fillet, A.M., Reux, I., Joberty, C. *et al.* (1996) Detection of human herpes virus 6 in AIDS-associated retinitis by means of *in situ* hybridization, polymerase chain reaction and immunohistochemistry. *Journal of Medical Virology*, **49**, 289–295.
- Flamand, L., Gosselin, J., DAddario, M. *et al.* (1991) Human herpesvirus 6 induces interleukin-1 beta and tumor necrosis factor alpha, but not interleukin-6, in peripheral blood mononuclear cell cultures. *Journal of Virology*, **65**, 5105–5110.
- Flamand, L., Goselin, J., Stefanescu, I. *et al.* (1995) Immunosuppressive effect of human herpesvirus 6 on T-cell functions: suppression of interleukin-2 synthesis and cell proliferation.

- Blood*, **85**, 1263–1271.
- Flamand, L., Stefanescu, I. and Menezes, J. (1996) Human herpesvirus-6 enhances natural killer cell cytotoxicity via IL-15. *Journal of Clinical Investigation*, **97**, 1373–1381.
- Foa-Tomasi, L., Boscaro, A., Di, G.S. *et al.* (1991) Monoclonal antibodies to gp 100 inhibit penetration of human herpesvirus 6 and polykaryocyte formation in susceptible cells. *Journal of Virology*, **65**, 4124–4129.
- Foa-Tomasi, L., Guerrini, S., Huang, T. *et al.* (1992) Characterization of human herpesvirus-6(U1102) and (GS) gp112 and identification of the Z29-specified homolog. *Virology*, **191**, 511–516.
- Foa-Tomasi, L., Avitabile, E. and CampadelliFiume, G. (1995) Selection of a monoclonal antibody specific for variant B human herpesvirus 6-infected mononuclear cells. *Journal of Virological Methods*, **51**, 289–296.
- Foa-Tomasi, L., Fiorilli, M.P., Avitabile, E. *et al.* (1996) Identification of an 85 kDa phosphoprotein as an immunodominant protein specific for human herpesvirus 7-infected cells. *Journal of General Virology*, **77**, 511–518.
- Fox, J.D., Briggs, M., Ward, P.A. *et al.* (1990) Human herpesvirus 6 in salivary glands. *Lancet*, **336**, 590–593.
- Frenkel, N., Schirmer, E.C., Katsafanas, G. *et al.* (1990a) T-cell activation is required for efficient replication of human herpesvirus 6. *Journal of Virology*, **64**, 4598–4602.
- Frenkel, N., Schirmer, E.C., Wyatt, L.S. *et al.* (1990b) Isolation of a new herpesvirus from human CD4 + T cells. *Proceedings of the National Academy of Sciences of the USA*, **87**, 748–752.
- Furlini, G., Vignoli, M., Ramazzotti, E. *et al.* (1996) A concurrent human herpesvirus-6 infection renders two human hematopoietic progenitor (TF-1 and KG-1) cell lines susceptible to human immunodeficiency virus type-1. *Blood*, **87**, 4737–4745.
- Furukawa, M., Yasukawa, M., Yakushijin, Y. *et al.* (1994) Distinct effects of human herpesvirus 6 and human herpesvirus 7 on surface molecule expression and function of CD4 + T cells. *Journal of Immunology*, **152**, 5768–5775.
- GautheretDejean A., Aubin, J.T., Poirel, L. *et al.* (1997) Detection of human *Betaherpesvirinae* in saliva and urine from immunocompromised and immunocompetent subjects. *Journal of Clinical Microbiology*, **35**, 1600–1603.
- Gompels, U.A., Carrigan, D.R., Carss, A.L. *et al.* (1993) Two groups of human herpesvirus 6 identified by sequence analyses of laboratory strains and variants from Hodgkin's lymphoma and bone marrow transplant patients. *Journal of General Virology*, **74**, 613–622.
- Gompels, U.A., Luxton, J., Kehl, K.K. *et al.* (1994) Chronic bone marrow suppression in immunocompetent adult by human herpesvirus 6. *Lancet*, **343**, 735–736.
- Gompels, U.A., Nicholas, N., Lawrence, G. *et al.* (1995) The DNA sequence of human herpesvirus-6: structure, coding content, and genome evolution. *Virology*, **209**, 29–51.
- Hall, C.B., Long, C.E., Schnabel, K.C. *et al.* (1994) Human herpesvirus-6 infection in children: a prospective study of complications and reactivation. *New England Journal of Medicine*, **331**, 432–438.
- Hasegawa, H., Utsunomiya, Y., Yasukawa, M. *et al.* (1994) Induction of G protein-coupled peptide receptor EBI 1 by human herpesvirus 6 and 7 infection in CD4 + T cells. *Journals of Virology*, **68**, 5326–5329.
- Herbein, G., Strasswimmer, J., Altieri, M. *et al.* (1996) Longitudinal study of human herpesvirus 6 infection in organ transplant recipients. *Clinical Infectious Diseases*, **22**, 171–173.
- Horvat, R.T., Parmely, M.J. and Chandran, B. (1993) Human herpesvirus 6 inhibits the proliferative responses of human peripheral blood mononuclear cells. *Journal of Infectious Diseases*, **167**, 1274–1280.
- Huang, L.M., Lee, C.Y., Liu, M.Y. *et al.* (1997) Primary infections of human herpesvirus-7 and herpesvirus-6: a comparative, longitudinal study up to 6 years of age. *Acta Paediatrica*, **86**, 604–608.
- Inagi, R., Guntapong, R., Nakao, M. *et al.* (1996) Human herpesvirus 6 induces IL-8 gene expression in human hepatoma cell line, Hep G2. *Journal of Medical Virology*, **49**, 34–40.
- Inoue, Y., Yasukawa, M. and Fujita, S. (1997) Induction of T-cell apoptosis by human herpesvirus 6. *Journal of Virology*, **71**, 3751–3759.
- Isegawa, Y., Ping, Z., Nakano, K., *et al.* (1998) Human herpesvirus 6 open reading frame U12 encodes a functional beta-chemokine receptor. *Journal of Virology*, **72**, 6104–6112.
- Isomura, H., Yamada, M., Yoshida, M. *et al.* (1997) Suppressive effects of human herpesvirus 6 on in vitro colony formation of hematopoietic progenitor cells. *Journal of Medical Virology*, **52**, 406–412.
- Iuliano, R., Trovato, R., Lico, S. *et al.* (1997) Human herpesvirus-6 reactivation in a longitudinal study of two HIV-1 infected patients. *Journal of Medical Virology*, **51**, 259–264.
- Kadokia, M.P., Rybka, W.B., Stewart, J.A. *et al.* (1996) Human herpesvirus 6: Infection and disease following autologous and allogeneic bone marrow transplantation. *Blood*, **87**, 5341–5354.
- Kamei, A., Ichinohe, S., Onuma, R. *et al.* (1997) Acute disseminated demyelination due to primary human herpesvirus-6 infection. *European Journal of Pediatrics*, **156**, 709–712.
- Kashanchi, F., Thompson, J., Sadaie, M.R. *et al.* (1994) Transcriptional activation of minimal HIV-1 promoter by ORF-1 protein expressed from the Sall-L fragment of human herpesvirus 6. *Virology*, **201**, 95–106.
- Kashanchi, F., Araujo, J., Doniger, J. *et al.* (1997) Human herpesvirus 6 (HHV-6) ORF-1 transactivating gene exhibits malignant transforming activity and its protein binds to p53. *Oncogene*, **14**, 359–367.
- Kasolo, F.C., Mpabalwani, E. and Gompels, U.A. (1997) Infection with AIDS-related herpesviruses in human immunodeficiency virus-negative infants and endemic childhood Kaposi's sarcoma in Africa. *Journal of General Virology*, **78**, 847–856.
- Katsafanas, G.C., Schirmer, E.C., Wyatt, L.S. *et al.* (1996) In vitro activation of human herpesviruses 6 and 7 from latency. *Proceedings of the National Academy of Sciences of the USA*, **93**, 9788–9792.
- Kempf, W., Adams, V., Wey, N. *et al.* (1997) CD68 + cells of monocyte/macrophage lineage in the environment of AIDS-associated and classic-sporadic Kaposi sarcoma are singly or doubly infected with human herpesviruses 7 and 6B. *Proceedings of the National Academy of Sciences of the USA*, **94**, 7600–7605.
- Kidd, I.M., Clark, D.A., Ait-Khaled, M. *et al.* (1996) Measurement of human herpesvirus 7 load in peripheral blood and saliva of healthy subjects by quantitative polymerase chain reaction. *Journal of Infectious Diseases*, **174**, 396–401.
- Knox, K.K. and Carrigan, D.R. (1992) In vitro suppression of bone marrow progenitor cell differentiation by human herpesvirus 6 infection. *Journal of Infectious Diseases*, **165**, 925–929.

- Knox, K.K. and Carrigan, D.R. (1994) Disseminated active HHV-6 infections in patients with AIDS. *Lancet*, **343**, 577–578.
- Knox, K.K. and Carrigan, D.R. (1995) Active human herpesvirus (HHV-6) infection of the central-nervous-system in patients with AIDS. *Journal of Acquired Immune Deficiency Syndromes and Human Retrovirology*, **9**, 69–73.
- Knox, K.K. and Carrigan, D.R. (1996) Active HHV-6 infection in the lymph nodes of HIV-infected patients: *in vitro* evidence that HHV-6 can break HIV latency. *Journal of Acquired Immune Deficiency Syndromes and Human Retrovirology*, **11**, 370–378.
- Knox, K.K., Harrington, D.P. and Carrigan, D.R. (1995a) Fulminant human herpesvirus-6 encephalitis in a human immunodeficiency virus-infected infant. *Journal of Medical Virology*, **45**, 288–292.
- Knox, K.K., Pietryga, D., Harrington, D.J. *et al.* (1995b) Progressive immunodeficiency and fatal pneumonitis associated with human herpesvirus 6 infection in an infant. *Clinical Infectious Diseases*, **20**, 406–413.
- Kondo, K., Kondo, T., Okuno, T. *et al.* (1991) Latent human herpesvirus 6 infection of human monocytes/macrophages. *Journal of General Virology*, **72**, 1401–1408.
- Kondo, K., Nagafuji, H., Hata, A. *et al.* (1993) Association of human herpesvirus 6 infection of the central nervous system with recurrence of febrile convulsions. *Journal of Infectious Diseases*, **167**, 1197–1200.
- Leach, C.T., Newton, E.R., McParlin, S. *et al.* (1994) Human herpesvirus 6 infection of the female genital tract. *Journal of Infectious Diseases*, **169**, 1281–1283.
- Levy, J.A., Landay, A. and Lennette, E.T. (1990) Human herpesvirus 6 inhibits human immunodeficiency virus type 1 replication in cell culture. *Journal of Clinical Microbiology*, **28**, 2362–2364.
- Li, C., Goodrich, J.M. and Yang, X. (1997) Interferon-gamma (IFN-gamma) regulates production of IL-10 and IL-12 in human herpesvirus-6 (HHV-6)-infected monocyte/macrophage lineage. [Full text available.] *Clinical and Experimental Immunology*, **109**, 421–425.
- Linde, A., Fridell, E., Dahl, H. *et al.* (1990) Effect of primary Epstein-Barr virus infection on human herpesvirus 6, cytomegalovirus, and measles virus immunoglobulin G titers. *Journal of Clinical Microbiology*, **28**, 211–215.
- Liu, D.X., Gompels, U.A., Foa-Tomasi, L. *et al.* (1993a) Human herpesvirus-6 glycoprotein H and L homologs are components of the gp100 complex and the gH external domain is the target for neutralizing monoclonal antibodies. *Virology*, **197**, 12–22.
- Liu, D.X., Gompels, U.A., Nicholas, J. *et al.* (1993b) Identification and expression of the human herpesvirus 6 glycoprotein H and interaction with an accessor 40K glycoprotein. *Journal of General Virology*, **74**, 1847–1857.
- Lusson, P., Ensoli, B., Markham, P.D. *et al.* (1989) Productive dual infection of human CD4 + T lymphocytes by HIV-1 and HHV-6. *Nature*, **337**, 370–373.
- Lusso, P., De, M.A., Malnati, M. *et al.* (1991a) Introduction of CD4 and susceptibility to HIV-1 infection in human CD8 + T lymphocytes by human herpesvirus 6. *Nature*, **349**, 533–535.
- Lusso, P., Malnati, M., De, M.A. *et al.* (1991b) Productive infection of CD4 + and CD8 + mature human T cell populations and clones by human herpesvirus 6: transcriptional down-regulation of CD3. *Journal of Immunology*, **147**, 685–691.
- Lusso, P., Malnati, M.S., GarzinoDemo, A. *et al.* (1993) Infection of natural killer cells by human herpesvirus 6. *Nature*, **362**, 458–462.
- Lusso, P., Secchiero, P., Crowley, R.W. *et al.* (1994) CD4 is a critical component of the receptor for human herpesvirus 7: interference with human immunodeficiency virus. *Proceedings of the National Academy of Sciences of the USA*, **91**, 3872–3876.
- Lusso, P., GarzinoDemo, A., Crowley, R.W. *et al.* (1995) Infection of gamma/delta T lymphocytes by human herpesvirus 6: transcriptional induction of CD4 and susceptibility to HIV infection. *Journal of Experimental Medicine*, **181**, 1303–1310.
- Martin, C., Enbom, M., Soderstrom, M. *et al.* (1997) Absence of seven human herpesvirus, including HHV-6, by polymerase chain reaction in CSF and blood from patients with multiple sclerosis and optic neuritis. *Acta Neurologica Scandinavia*, **95**, 280–283.
- Megaw, A.G., Rapaport, D., Avidor, B. *et al.* (1998) The DNA sequence of the RK strain of human herpesvirus 7. *Virology*, **244**, 119–132.
- Merelli, E., Sola, P., Barozzi, P. *et al.* (1996) An encephalitic episode in a multiple sclerosis patient with human herpesvirus 6 latent infection. *Journal of the Neurological Sciences*, **137**, 42–46.
- Merelli, E., Bedin, R., Sola, P. *et al.* (1997) Human herpes virus 6 and human herpes virus 8 DNA sequences in brains of multiple sclerosis patients, normal adults and children. *Journal of Neurology*, **244**, 450–454.
- Moschetti, D., Balestri, P., Fois, A. *et al.* (1996) Acute encephalitis due to human herpesvirus 6. *Clinical Infectious Diseases*, **23**, 397–398.
- Nakagawa, N., Mukai, T., Sakamoto, J. *et al.* (1997) Antigenic analysis of human herpesvirus 7 (HHV-7) and HHV-6 using immune sera and monoclonal antibodies against HHV-7. *Journal of General Virology*, **78**, 1131–1137.
- Neipel, F., Ellinger, K. and Fleckenstein, B. (1992) Gene for the major antigenic structural protein (p100) of human herpesvirus 6. *Journal of Virology*, **66**, 3918–3924.
- Nicholas, J. (1996) Determination and analysis of the complete nucleotide sequence of human herpesvirus 7. *Journal of Virology*, **70**, 5975–5989.
- Novoa, L.J., Nagra, R.M., Nakawatase, T. *et al.* (1997) Fulminant demyelinating encephalomyelitis associated with productive HHV-6 infection in an immunocompetent adult. *Journal of Medical Virology*, **52**, 301–308.
- Okada, K., Ueda, K., Kusuhara, K. *et al.* (1993) Exanthema subitum and human herpesvirus 6 infection: clinical observations in fifty-seven cases. *Pediatric Infectious Disease Journal*, **12**, 204–208.
- Okuno, T., Shao, H., Asada, H. *et al.* (1992) Analysis of human herpesvirus 6 glycoproteins recognized by monoclonal antibody OHV1. *Journal of General Virology*, **73**, 443–447.
- Osman, H., Peiris, J., Taylor, C.E. *et al.* (1996) ‘Cytomegalovirus disease’ in renal allograft recipients: is human herpesvirus 7 a co-factor for disease progression? *Journal of Medical Virology*, **48**, 295–301.
- Pellett, P.E., Sanchez-Martinez, D., Dominguez, G. *et al.* (1993) A strongly immunoreactive virion protein of human herpesvirus 6 variant B strain Z29: identification and characterization of the gene and mapping of a variant-specific monoclonal antibody reactive epitope. *Virology*, **195**, 521–531.

- Pfeiffer, B., Berneman, Z.N., Neipel, F. *et al.* (1993) Identification and mapping of the gene encoding the glycoprotein complex gp82-gp105 of human herpesvirus 6 and mapping of the neutralizing epitope recognized by monoclonal antibodies. *Journal of Virology*, **67**, 4611–4620.
- Portolani, M., Cermelli, C., Moroni, A. *et al.* (1993) Human herpesvirus-6 infections in infants admitted to hospital. *Journal of Medical Virology*, **39**, 146–151.
- Portolani, M., Cermelli, C., Meacci, M. *et al.* (1997) Primary infection by HHV-6 variant B associated with a fatal case of hemophagocytic syndrome. *Microbiologica*, **20**, 7–11.
- Pruksananonda, P., Hall, C.B., Insel, R.A. *et al.* (1992) Primary human herpesvirus 6 infection in young children. *New England Journal of Medicine*, **326**, 1445–1450.
- Ratnamohan, V.M., Chapman, J., Howse, H. *et al.* (1998) Cytomegalovirus and human herpesvirus 6 both cause viral disease after renal transplantation. *Transplantation*, **66**, 877–882.
- Rawlinson, W.D., Farrell, H.E. and Barrell, B.G. (1996) Analysis of the complete DNA sequence of murine cytomegalovirus. *Journal of Virology*, **70**, 8833–8849.
- Reymen, D., Naesens, L., Balzarini, J. *et al.* (1995) Antiviral activity of selected acyclic nucleoside analogues against human herpesvirus 6. *Antiviral Research*, **28**, 343–357.
- Roffman, E. and Frenkel, N. (1990) Interleukin-2 inhibits the replication of human herpesvirus-6 in mature thymocytes. *Virology*, **175**, 591–594.
- Roffman, E. and Frenkel, N. (1991) Replication of human herpesvirus-6 in thymocytes activated by anti-CD3 antibody (8). *Journal of Infectious Diseases*, **164**, 617–618.
- Rotola, A., Ravaioli, T., Gonelli, A. *et al.* (1998) U94 of human herpesvirus 6 is expressed in latently infected peripheral blood mononuclear cells and blocks viral gene expression in transformed lymphocytes in culture. *Proceedings of the National Academy of Sciences of the USA*, **95**, 13911–13916.
- Sada, E., Yasukawa, M., Ito, C. *et al.* (1996) Detection of human herpesvirus 6 and human herpesvirus 7 in the submandibular gland, parotid gland, and lip salivary gland by PCR. *Journal of Clinical Microbiology*, **34**, 2320–2321.
- Schiewe, U., Neipel, F., Schreiner, D. *et al.* (1994) Structure and transcription of an immediate-early region in the human herpesvirus 6 genome. *Journal of Virology*, **68**, 2978–2985.
- Secchiero, P., Carrigan, D.R., Asano, Y. *et al.* (1995) Detection of human herpesvirus 6 in plasma of children with primary infection and immunosuppressed patients by polymerase chain reaction. *Journal of Infectious Diseases*, **171**, 273–280.
- Secchiero, P., Flamand, L., Gibellini, D. *et al.* (1997a) Human herpesvirus 7 induces CD4(+) T-cell death by two distinct mechanisms: necrotic lysis in productively infected cells and apoptosis in uninfected or nonproductively infected cells. *Blood*, **90**, 4502–4512.
- Secchiero, P., Gibellini, D., Flamand, L. *et al.* (1997b) Human herpesvirus 7 induces the down-regulation of CD4 antigen in lymphoid T cells without affecting p56(lck) levels. *Journal of Immunology*, **159**, 3412–3423.
- Singh, N., Carrigan, D.R., Gayowski, T. *et al.* (1997) Human herpesvirus-6 infection in liver transplant recipients: documentation of pathogenicity. *Transplantation*, **64**, 674–678.
- Soldan, S.S., Berti, R., Salem, N. *et al.* (1997) Association of human herpesvirus 6 (HHV-6) with multiple sclerosis: increased IgM response to HHV-6 early antigen and detection of serum HHV-6 DNA. *Nature Medicine*, **3**, 1394–1397.
- Stefan, A., Secchiero, P., Baechi, T. *et al.* (1997) The 85-kilodalton phosphoprotein (pp85) of human herpesvirus 7 is encoded by open reading frame U14 and localizes to a tegument substructure in virion particles. *Journal of Virology*, **71**, 5758–5763.
- Suga, S., Yoshikawa, T., Asano, Y. *et al.* (1992) Activation of human herpesvirus-6 in children with acute measles. *Journal of Medical Virology*, **38**, 278–282.
- Suga, S., Yoshikawa, T., Asano, Y. *et al.* (1993) Clinical and virological analyses of 21 infants with exanthem subitum (roseola infantum) and central nervous system complication. *Annals of Neurology*, **33**, 597–603.
- Tait, D.R., Ward, K.N., Brown, D. *et al.* (1996) Measles and rubella misdiagnosed in infants as exanthem subitum (roseola infantum). *BMJ*, **312**, 101–102.
- Takahashi, K., Sonoda, S., Higashi, K. *et al.* (1989) Predominant CD4 T-lymphocyte tropism of human herpesvirus 6-related virus. *Journal of Virology*, **63**, 3161–3163.
- Takahashi, K., Suzuki, M., Iwata, Y. *et al.* (1997) Selective activity of various nucleoside and nucleotide analogues against human herpesvirus 6 and 7. *Antiviral Chemistry and Chemotherapy*, **8**, 24–31.
- Takeda, K., Haque, M., Sunagawa, T. *et al.* (1997) Identification of a variant B-specific neutralizing epitope on glycoprotein H of human herpesvirus-6. *Journal of General Virology*, **78**, 2171–2178.
- Tanaka, K., Kondo, T., Torigoe, S. *et al.* (1994) Human herpesvirus 7: another causal agent for roseola (exanthem subitum). *Journal of Pediatrics*, **125**, 1–5.
- Tanaka-Taya, K., Kondo, T., Mukai, T. *et al.* (1996) Seroepidemiological study of human herpesvirus-6 and -7 in children of different ages and detection of these two viruses in throat swabs by polymerase chain reaction. *Journal of Medical Virology*, **48**, 88–94.
- Thompson, J., Choudhury, S., Kashanchi, F. *et al.* (1994) A transforming fragment within the direct repeat region of human herpesvirus type 6 that transactivates HIV-1. *Oncogene*, **9**, 1167–1175.
- Thomson, B.J., Weindler, F.W., Gray, D. *et al.* (1994) Human herpesvirus 6 (HHV-6) is a helper virus for adeno-associated virus type 2 (AAV-2) and the AAV-2 rep gene homologue in HHV-6 can mediate AAV-2 DNA replication and regulate gene expression. *Virology*, **204**, 304–311.
- Tigue, N.J., Matharu, P.J., Roberts, N.A. *et al.* (1996) Cloning, expression, and characterization of the proteinase from human herpesvirus 6. *Journal of Virology*, **70**, 4136–4141.
- Torigoe, S., Koide, W., Yamada, M. *et al.* (1996) Human herpesvirus 7 infection associated with central nervous system manifestations. *Journal of Pediatrics*, **129**, 301–305.
- Valente, G., Secchiero, P., Lusso, P. *et al.* (1996) Human herpesvirus 6 and Epstein-Barr virus in Hodgkin's disease: a controlled study by polymerase chain reaction and *in situ* hybridization. *American Journal of Pathology*, **149**, 1501–1510.
- Van Loon, N.M., Gummuluru, S., Sherwood, D.J. *et al.* (1995) Direct sequence analysis of human herpesvirus 6 (HHV-6) sequences from infants and comparison of HHV-6 from mother/infant pairs. *Clinical Infectious Diseases*, **21**, 1017–1019.
- Vinters, H.V., Wang, R. and Wiley, C.A. (1993) Herpesviruses in chronic encephalitis associated with intractable childhood epi-

- lepsy. *Human Pathology*, **24**, 871–879.
- Wang, F.Z., Dahl, H., Linde, A. *et al.* (1996) Lymphotropic herpesviruses in allogeneic bone marrow transplantation. *Blood*, **88**, 3615–3620.
- Ward, K.N., Gray, J.J. and Efstathiou, S. (1989) Brief report: Primary human herpesvirus 6 infection in a patient following liver transplantation from a seropositive donor. *Journal of Medical Virology*, **28**, 69–72.
- Ward, K.N., Gray, J.J., Fotheringham, M.W. *et al.* (1993a) IgG antibodies to human herpesvirus-6 in young children: changes in avidity of antibody correlate with time after infection. *Journal of Medical Virology*, **39**, 131–138.
- Ward, K.N., Gray, J.J., Joslin, M.E. *et al.* (1993b) Avidity of IgG antibodies to human herpesvirus-6 distinguishes primary from recurrent infection in organ transplant recipients and excludes cross-reactivity with other herpesviruses. *Journal of Medical Virology*, **39**, 44–49.
- Webb, D.W., Bjornson, B.H., Sargent, M.A. *et al.* (1997) Basal ganglia infarction associated with HHV-6 infection. *Archives of Disease in Childhood*, **76**, 362–364.
- Whitley, R.J. (1997) The management of herpesvirus infections in individuals with human immunodeficiency virus or AIDS. *Antiviral Therapy*, **2**, 25–28.
- Wilborn, F., Brinkmann, V., Schmidt, C.A. *et al.* (1994a) Herpesvirus type 6 in patients undergoing bone marrow transplantation: serologic features and detection by polymerase chain reaction. *Blood*, **83**, 3052–3058.
- Wilborn, F., Schmidt, C.A., Brinkmann, V. *et al.* (1994b) A potential role for human herpesvirus type 6 in nervous system disease. *Journal of Neuroimmunology*, **49**, 213–214.
- Xu, Y.H., Zhaori, G., Vene, S. *et al.* (1996) Viral etiology of acute childhood encephalitis in Beijing diagnosed by analysis of single samples. *Pediatric Infectious Disease Journal*, **15**, 1018–1024.
- Yamamoto, T., Mukai, T., Kondo, K. *et al.* (1994) Variation of DNA sequence in immediate-early gene of human herpesvirus 6 and variant identification by PCR. *Journal of Clinical Microbiology*, **32**, 473–476.
- Yasukawa, M., Yakushijin, Y., Furukawa, M. *et al.* (1993) Specificity analysis of human CD4 + T-cell clones directed against human herpesvirus 6 (HHV-6), HHV-7, and human cytomegalovirus. *Journal of Virology*, **67**, 6259–6264.
- Yasukawa, M., Inoue, Y., Ohminami, H. *et al.* (1997) Human herpesvirus 7 infection of lymphoid and myeloid cell lines transduced with an adenovirus vector containing the CD4 gene. *Journal of Virology*, **71**, 1708–1712.
- Yoshida, R., Imai, T., Hieshima, K. *et al.* (1997) Molecular cloning of a novel human CC chemokine EB11–ligand chemokine that is specific functional ligand for EB11, CCR7. *Journal of Biological Chemistry*, **272**, 13803–13809.
- Yoshikawa, T., Suga, S., Asano, Y. *et al.* (1989) Distribution of antibodies to a causative agent of exanthem subitum (human herpesvirus-6) in healthy individuals. *Pediatrics*, **84**, 675–677.
- Yoshikawa, T., Nakashima, T., Suga, S. *et al.* (1992) Human herpesvirus-6 DNA in cerebrospinal fluid of a child with exanthem subitum and meningoencephalitis. *Pediatrics*, **89**, 888–890.
- Yoshikawa, T., Asano, Y., Kobayashi, I. *et al.* (1993) Seroepidemiology of human herpesvirus 7 in healthy children and adults in Japan. *Journal of Medical Virology*, **41**, 319–323.

Kaposi's Sarcoma-associated Herpesvirus (Human herpesvirus 8)

Thomas F. Schulz
University of Liverpool, Liverpool, UK

INTRODUCTION

The eighth human herpesvirus discovered recently is associated with three human neoplasias. It was first discovered in Kaposi's sarcoma (KS), with which it is strongly associated, hence the designation Kaposi's sarcoma-associated herpesvirus (KSHV) (Chang *et al.*, 1994). It is also found consistently in a very rare form of B cell lymphoma, body-cavity associated lymphoma (BCBL) or primary effusion lymphoma (PEL). Finally, it is found in some, but not all, cases of multicentric Castleman's disease (MCD), in particular those arising in individuals infected with human immunodeficiency virus (HIV). To reflect its association with conditions other than KS, and to keep within the nomenclature adopted for other human herpesviruses, the term *Human herpesvirus 8* (HHV-8) is preferred by some researchers.

For more than two decades a series of epidemiological studies had suggested strongly the involvement of a transmissible agent in the pathogenesis of KS, but attempts by several groups to identify such an organism by conventional culture or morphological approaches had been unsuccessful (reviewed in Schulz and Weiss, 1995). The development of molecular techniques combining polymerase chain reaction (PCR) amplification with subtractive hybridization (representational difference analysis, RDA), allowed Chang *et al.* (1994) to

search for unknown DNA sequences present in KS but not a control tissue. They identified initially two small DNA fragments with homologies to two oncogenic γ herpesviruses, *Epstein-Barr virus* (EBV) and *Herpesvirus saimiri* (HVS) of squirrel monkeys. These were later shown to be part of a complete viral genome (Russo *et al.*, 1996), present in the endothelial tumour (spindle) cells of KS lesions (Boshoff *et al.*, 1995). After the discovery of KSHV in primary effusion lymphomas (Cesarman *et al.*, 1995), several groups succeeded in establishing persistently infected cell lines from such lymphomas, and subsequently visualizing KSHV virions after chemical induction of the lytic replication cycle (Renne *et al.*, 1996; Said *et al.*, 1996; further references in Schulz, 1998). Four years after its initial discovery, the available epidemiological and molecular evidence suggests strongly that KSHV is the cause of KS and PEL, and thus a new human tumour virus.

THE VIRUS

Morphology and Culture

KSHV has the characteristic morphological appearance of a herpesvirus (Chapter 2). An example of a KSHV virion, produced by the PEL-derived KS-1 cell line (Said *et al.*, 1996) after induction of the

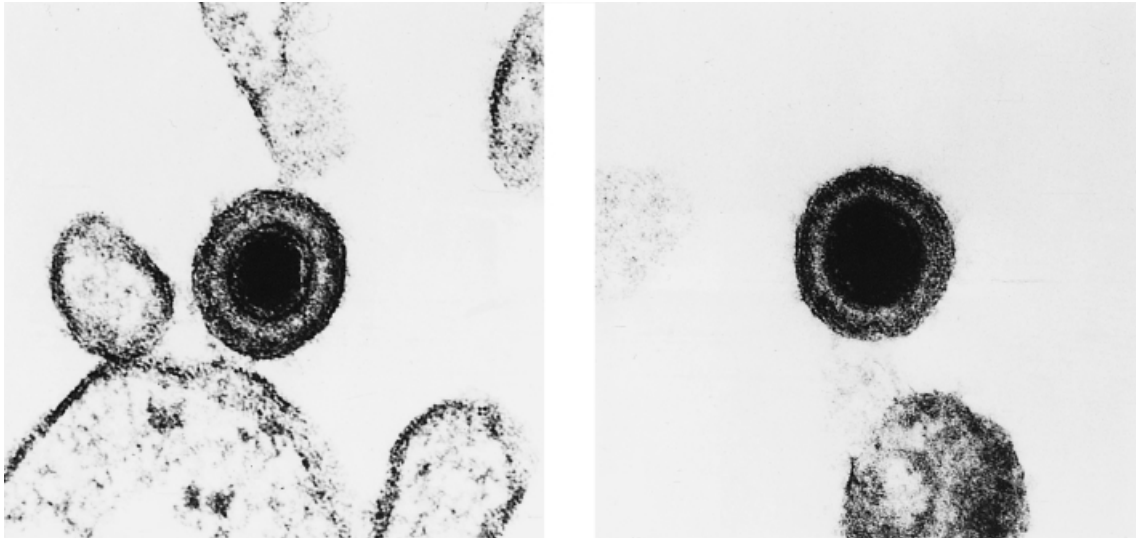

Figure 2F.1 Electron micrograph of KSHV in lytically induced KS-1 cells (Said *et al.*, 1996). The KSHV virion has the characteristic features of a herpesvirus. (Courtesy of D. Ablashi, Advanced Biotechnologies)

lytic cycle by treatment with phorbol esters, is shown in Figure 2F.1. PEL-derived cell lines may be infected latently with KSHV only, or may be coinfecting with EBV, if the original tumour also contained EBV (Renne *et al.*, 1996; Said *et al.*, 1996; further references in Schulz, 1998). In cell lines which are only infected with KSHV (e.g. BCP-1, BCBL-1, KS-1) most cells only express latent KSHV genes (see below), but some will switch spontaneously into lytic replication. In contrast, the dually KSHV/EBV infected cell line HBL-6 (or BC-1) is much more strictly latent. The lytic replication programme can be switched on in all these cell lines by treatment with either phorbol esters (Renne *et al.*, 1996) or Na-butyrate (Miller *et al.*, 1996), but some cell lines are better virus producers (e.g. KS-1) than others. KSHV virus preparations obtained in this manner are infectious *in vitro* and can, albeit only inefficiently and transiently, be propagated on the 293 embryonal kidney cell line (Foreman *et al.*, 1997). It is also possible to isolate replicating KSHV on 293 cells from KS biopsies (Foreman *et al.*, 1997) or saliva (Vieira *et al.*, 1997), but detection of replicating KSHV requires the use of PCR and can usually only be sustained for a few passages.

Phylogeny and Genome Organization

Phylogenetic analysis of its genomic sequence

(Russo *et al.*, 1996; Neipel *et al.*, 1997) places KSHV with the γ_2 subgroup of herpesvirus, the rhadinoviruses (Figure 2F.2). This group includes several other animal herpesviruses such as HVS, *Equine herpesvirus 2* (EHV-2), *Murine herpesvirus 68* (MHV-68), and three recently discovered rhadinoviruses of macaques, *Macaca nemestrina* (RFHVMm) and *Macaca mulatta* (RFHVMm and RRV) (Desrosiers *et al.*, 1997; Rose *et al.*, 1997). EBV, the only other known human γ herpesvirus, is classified as a γ_1 herpesvirus. At present, KSHV appears to be most closely related to the three macaque rhadinoviruses (Figure 2F.2). This close relationship is supported by a very similar organisation of the RRV genome, including the presence in RRV of a homologue of IL-6 (Desrosiers *et al.*, 1997), and other viral genes first found in KSHV (see below). The KSHV genome shares with two of the macaque viruses (RFHVMm, RFHVMn) also a higher GC content and CpG ratio than is found in other rhadinoviruses, in particular HVS, which could be indicative of latent persistence in resting rather than dividing cells (Rose *et al.*, 1997). It is therefore possible that the present group of Old World γ_2 herpesviruses will be further subdivided in future.

The genome structure of KSHV is similar to that of other γ herpesviruses (Figure 2F.3). A long unique region (LUR) of 140.5 kb is flanked by multiple 801 bp terminal repeats (TRS) of high (85%) GC content, which are involved in the

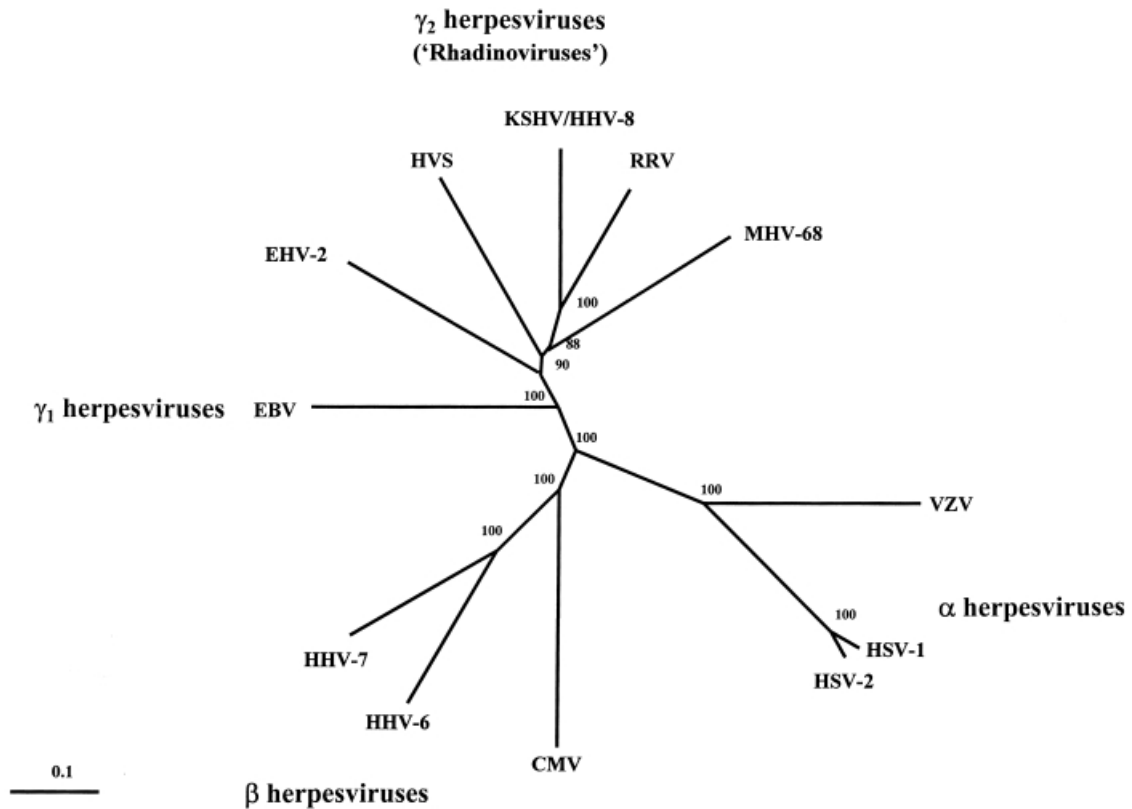

Figure 2F.2 Phylogenetic relationship between herpesviruses. The phylogenetic tree shown here was created by the neighbour-joining method of the glycoprotein B sequence of all the herpesviruses shown. For the α - and β -herpesvirus group only human viruses are shown. To illustrate the relationship between KSHV and other γ herpesviruses, the gB sequence of several nonhuman viruses were included. Numbers at branch points denote bootstrap values to indicate the reliability of this analysis (values over 75% are generally taken to indicate a robust assignment to a branch). The figure shows that KSHV belongs to the subgroup of γ_2 herpesviruses ('rhadinoviruses') and appears most closely related to a rhadinovirus of rhesus macaques (RRV), shown here as a representative for a group of three closely related macaque viruses (see text). These four viruses may define a further subgroup within the 'rhadinoviruses' (see text)

packaging of the viral genome. At present at least 83 viral genes have been either predicted, or documented experimentally, within the LUR, and others may be found in the future (Russo *et al.*, 1996; Neiper *et al.*, 1997; Nicholas *et al.*, 1997a).

Like other herpesvirus genomes, that of KSHV contains genes encoding proteins which are required for replication and assembly of new virus progeny. These are grouped together and arranged in six blocks (gene blocks I–IV', IV'', V), as shown in Figure 2F.3. The designation of these conserved viral genes follows the nomenclature previously adopted for HVS, the first γ_2 herpesvirus to be fully sequenced. Genes that are unique to KSHV have been designated with a 'K' prefix (for KSHV) and numbered sequentially. These are located in six 'non-conserved' gene blocks (Figure 2F.3). These

gene blocks also contain genes which are found in some other (but not all) rhadinoviruses. (Russo *et al.*, 1996; Neipel *et al.*, 1997; Nicholas *et al.*, 1997a).

Function of Individual Viral Genes

'Conserved' Viral Genes

Only a few studies have so far been carried out on viral proteins encoded within the 'conserved' gene blocks I–V, and it is likely that their function is similar to that of their counterparts in other herpesviruses (Chapters 2 and 2A–E). Open reading frame (ORF) 17 in gene block II (Figure 2F.3) has been shown to encode the viral proteinase and assembly protein which is required for the proteolytic processing of capsid proteins. ORF 50 encodes the

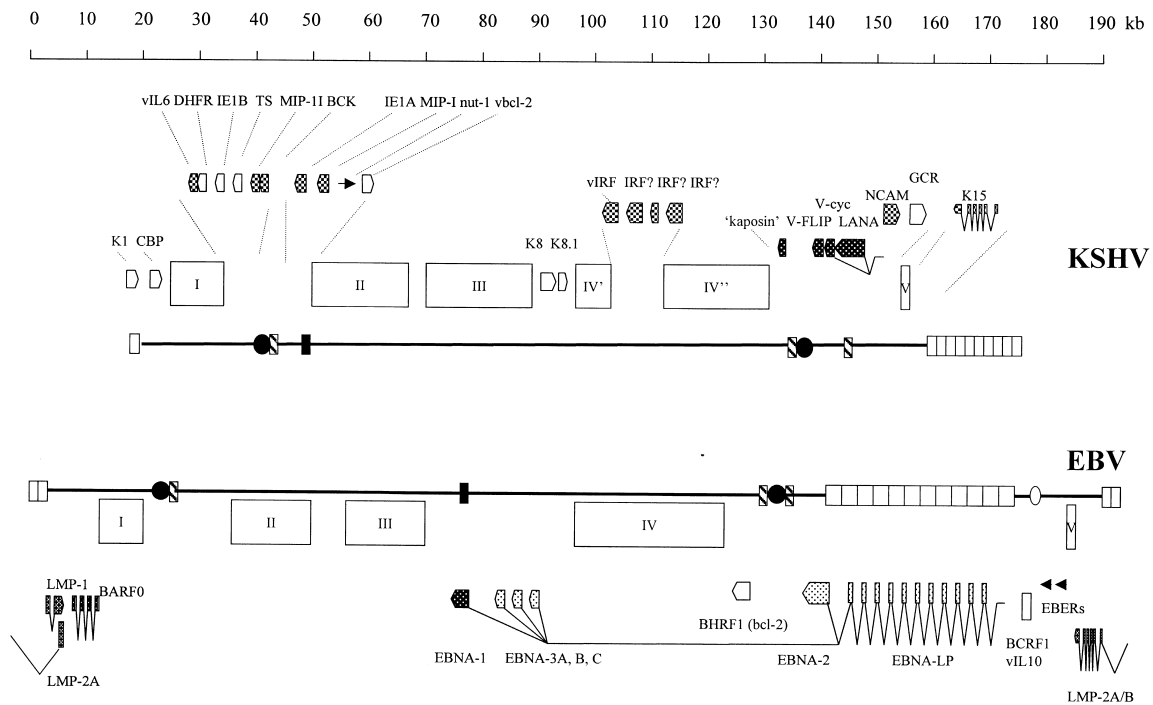

Figure 2F.3 A comparison of the genomes of the two human γ herpesviruses, EBV and KSHV. Open boxes with roman numbers denote groups of structural genes which are conserved among γ herpesviruses and also many other herpesviruses. The solid line represents the long unique (coding) region; open rectangles internal or terminal repeat regions. Solid circles in the EBV genome represent ori-Lyt (L) and ori-Lyt(R), the open circle ori-P. Solid circles in the KSHV genome represent putative ori-(L) and ori-(R) domains. Small hatched boxes represent GC-rich repeats and inverted palindromic areas. The position and transcriptional orientation of viral genes discussed in the text is indicated by pointed boxes. In KSHV, dark shading indicates genes known to be expressed in latently infected spindle cells and PEL cells (see text), chequered boxes represent genes which are weakly expressed in PEL cells, but whose expression is inducible by phorbol esters or butyrate (see text). As far as this has been investigated, these are only expressed in lytically infected KS spindle cells or in infiltrating mononuclear cells, but not in latently infected spindle cells. The viral IL6 is expressed in PEL cells and B-cells of MCD lesions *in vivo* (see text). Open (pointed) boxes indicate 'class III' genes (see text). The arrow represents the nut-1/T1.1 untranslated RNA expressed during lytic replication. Lines joining LANA and v-cyc represent the alternative splicing pattern for these genes (see text). In EBV, dark shading indicates genes expressed during type I latency (EBNA-1, BARF0), cross-hatched genes are in addition expressed during type II latency (LMP1, 2A/2B), and stippled genes also during type III latency (EBNA-2, 3A, 3B, 3C, EBNA-LP). Lines joining the different genes represent the splicing pattern for latent genes (see page 173)

equivalent of the EBV R transactivator, upregulates several early genes, and may play a role in the switch from latency to lytic replication (Sun *et al.*, 1998).

'Non-conserved' Viral Genes

More information is available presently on viral proteins which are either unique to KSHV, or shared by KSHV and only some other γ herpesviruses.

Transmembrane proteins. ORFK1, at the left end of the viral genome, is predicted to encode a

membrane glycoprotein with a cysteine-rich extracellular domain, a single transmembrane domain, and a cytoplasmic domain containing several potential tyrosine phosphorylation sites. K1 has transforming properties in T cells when recombined into a *herpesvirus saimiri* vector, and in rodent fibroblasts (Lee *et al.*, 1998a). Its cytoplasmic domain can activate intracellular signalling cascades involving Syk, vav, PI3 kinase and induce Ca^{2+} influx (Lee *et al.*, 1998b). K1 is not expressed in latently infected PEL cell lines, and appears to be an immediate early or early gene (Russo *et al.*, 1996; Lagunoff and Ganem, 1997; Neipel *et al.*, 1997). Whether it is expressed *in vivo* in latently infected KS spindle (endothelial tumour) cells or PEL re-

mains to be investigated, and its role in the pathogenesis of KSHV-associated neoplasia therefore requires further detailed study. There is considerable sequence variability in the K1 coding region among different KSHV isolates. While the biological significance of this sequence variability is still unknown, it can be used for phylogenetic studies to define different KSHV lineages (see below).

ORK K8.1 (Figure 2F.3) encodes, by means of alternative splicing, two transmembrane glycoproteins. This feature, and the position of ORF K8.1 in the viral genome, makes it a likely equivalent of EBV gp340/220, which is involved in the binding of EBV to its receptor (Raab *et al.*, 1998). The K8.1 glycoprotein, gp35/37, is immunogenic and recognized by sera from most KSHV-infected individuals and is therefore a good diagnostic antigen (see below).

Similar to HHV-6 and HHV-7, KSHV contains a homologue of an NCAM-like adhesion molecule, encoded by ORF K14 (Russo *et al.*, 1996). Its function is still unknown.

The ORF 74 gene encodes a member of the family of seven transmembrane domain G-protein-coupled receptors (GCRs). Members of this family are also found in several herpesviruses, including cytomegalovirus (CMV) and HVS. Transient expression studies of the KSHV v-GCR indicate that it binds to several CXC and CC chemokines and that it appears constitutively active (Arvanitakis *et al.*, 1997). The KSHV GCR enhances the proliferation of rat kidney fibroblast (NRK-49F) cells, transforms rodent fibroblasts to tumourigenicity, and induces the secretion of vascular endothelial growth factor (VEGF) (Arvanitakis *et al.*, 1997; Bais *et al.*, 1998). However, v-GCR appears not to be expressed in latently infected PEL cells (Sarid *et al.*, 1998; Figure 2F.3) and it is still unclear whether it is expressed in neoplastic cells *in vivo*.

Another membrane protein, with multiple transmembrane regions and a c-terminal cytoplasmic domain (ORF K15/LAMP'), is encoded at the 'right' end of the viral genome and has similarities to the two latent membrane proteins of EBV, LMP 1 and LMP 2 (Poole *et al.*, 1999; Glenn *et al.*, 1999). Like LMP 2, which is thought to play a role in the control of EBV latency, ORF K15 has up to 10 transmembrane regions (alternative splicing results in smaller proteins with fewer transmembrane segments) and a cytoplasmic domain with putative SH2-binding sites (Glenn *et al.*, 1999). As in LMP 1,

the cytoplasmic domain is located at the C-terminal end and contains possible binding sites for TRAFs, known to be involved in NF κ B activation induced by the TNF receptor and LMP 1 (Glenn *et al.*, 1999). The ORF K15/LAMP' transcript is weakly expressed in PEL cell lines *in vitro*, but nothing is known at present about its expression in tumour cells *in vivo*.

Cytokines encoded by KSHV. A large block of 'non-conserved' viral genes contains several with homologies to mammalian proteins and appears more extensive than in other rhadinoviruses (Russo *et al.*, 1996; Neipel *et al.*, 1997; Nicholas *et al.*, 1997a, 1997b, 1998; Figure 2F.3). Several growth factor homologues, including vIL-6 (ORF K2) two MIP-I α homologues (ORF K4/v-MIP-II; ORF K6/v-MIP-I) and a MIP-I β homologue (ORF K4.1; MIP-III) are encoded in this region (Russo *et al.*, 1996; Neipel *et al.*, 1997; Nicholas *et al.*, 1997a, 1997b).

The IL-6 homologue encoded by ORF K2 is capable of maintaining the proliferation of IL-6-dependent mouse and human myeloma cell lines (Moore *et al.*, 1996; Neipel *et al.*, 1997; Nicholas *et al.*, 1997b). Similar to human IL-6, v-IL-6 activates STAT1, STAT3 and Jak1 phosphorylation in HEP-2 hepatoma cells (Molden *et al.*, 1997). In contrast to human IL-6, v-IL-6 appears not to require the α chain (gp80) of the IL-6 receptor complex and to use exclusively its β chain (gp130) (Molden *et al.*, 1997; Nicholas *et al.*, 1997b). v-IL-6 is secreted by PEL cells infected by KSHV, expressed by CD20 + B cells in lymphoid tissues from KSHV-infected patients and in multicentric Castleman's disease, but not in KS tissues, suggesting that v-IL-6 may contribute to the proliferation of hematopoietic but not endothelial cells (Moore *et al.*, 1996; detailed references in Schulz, 1998; Schulz *et al.*, 1998).

The KSHV genome also encodes three proteins with significant sequence similarity to cellular chemokines (Moore *et al.*, 1996; Russo *et al.*, 1996; Boshoff *et al.*, 1997; Kledal *et al.*, 1997; Neipel *et al.*, 1997). The protein encoded by ORF K6 (MIP-I homologue) has been shown to interact with the CCR5 chemokine receptor and to block the entry of CCR5-dependent primary HIV-1 strains (Moore *et al.*, 1996). The ORF K4 encoded chemokine (v-MIP-II) interacts preferentially with CCR3, inhibits the entry of dual-tropic HIV-1 strains and is

chemotactic for eosinophils. Both v-MIP-I and v-MIP-II have angiogenic properties when tested on the chorioallantoic membrane (Boshoff *et al.*, 1997). There is some basal expression of v-MIP-I and v-MIP-II in PEL cell lines, which increases markedly after induction of the lytic cycle (Moore *et al.*, 1996). v-MIP-II appears to be expressed only in cells infected lytically within KS lesions, but not in the majority of (latently infected) spindle cells. Although not yet firmly established, it is conceivable that these viral chemokines, released by cells lytically infected, may play a role in the development of KS by promoting neoangiogenesis, eosinophil infiltration, or the proliferation of spindle cells latently infected (see below),

Viral proteins with antiapoptotic properties.

Many different viruses encode proteins capable of inhibiting apoptosis. Most of these are expressed during lytic viral replication and are thought to prolong the survival of virus-infected cells (Teodoro and Branton, 1997). KSHV encodes two proteins with antiapoptotic activity, one of which is expressed during lytic replication, the other during latency.

Like two other γ herpesviruses, HVS and EBV, KSHV encodes a Bcl-2 homologue (ORF 16). Functional studies indicate that KSHV v-Bcl-2 prevents bax-mediated apoptosis. v-Bcl-2, like its EBV homologue BHRF1, appears to be expressed primarily during lytic virus replication (Sarid *et al.*, 1997, 1998; further references in Schulz, 1998; Schulz *et al.*, 1998). Thus, KSHV Bcl-2, like other viral members of this family, may be primarily active during lytic replication, during which time the cell may be particularly prone to apoptotic responses (Teodoro and Branton, 1997).

KSHV ORF K13, HVS ORF 71, and the corresponding E8 protein of EHV-2, as well as the molluscum contagiosum virus MC159 protein, contain two domains with significant homology to mammalian 'death effector domains' (DEDs) (Thome *et al.*, 1997). DEDs are characteristic for the cytoplasmic adaptor molecule FADD (MORT1) and the N-terminal prodomain of FLICE (caspase 8). They mediate the interaction between these two proteins during apoptosis triggered by activation of the Fas/C95 or TNFR1 pathway. EHV-2 (E8) protein acts as a dominant negative inhibitor of Fas/CD95-mediated apoptotic signalling and hence has been

given the name FLICE-inhibitor protein (v-FLIP) (Thome *et al.*, 1997). The presence of DEDs in KSHV K13 suggests a similar role. Whereas HVS ORF 71 is expressed during lytic replication and, like v-BCL-2, has been hypothesized to protect cells infected lytically against apoptosis (Thome *et al.*, 1997), KSHV K13 is encoded on a bicistronic mRNA which also codes for ORF 72, the viral homologue of a D-type cyclin (see below), and which is expressed in latently infected PEL cell lines and KS spindle cells (Davies *et al.*, 1997; Rainbow *et al.*, 1997; Sarid *et al.*, 1998; further references in Schulz, 1998) (Figure 2F.3). It is therefore conceivable that KSHV v-FLIP (K13) may play a role in latently infected KS spindle and B lymphoma cells.

Interferon regulatory factors (v-IRFs).

Four genes, which are so far unique to KSHV, have homologies to interferon regulatory factors (IRFs) (Figure 2F.3) (Russo *et al.*, 1996; Neipel *et al.*, 1997), and one of these (ORF K9/vIRF-1) has been characterized functionally. Transfection of ORF K9/v-IRF-1 into 293 and HeLa cells inhibits interferon-induced gene transcription as measured in a reporter assay, and may thus mimic the role of cellular IRF-2, a negative regulator of interferon-mediated signalling (Gao *et al.*, 1997). There is low basal expression of ORF K9/vIRF-1 in BCBL/PEL cell lines, which is markedly enhanced after induction of the lytic cycle (Moore *et al.*, 1996). However, ORF K9/vIRF-1 does not appear to be expressed in tumour cells *in vivo*. ORF K9/vIRF-1 may contribute to the survival of KSHV infected cells, in particular during the lytic replication cycle, by opposing the interferon-mediated host response. Transfection of K9/v-IRF-1 under a strong promoter into 3T3 cells results in transformation and tumour formation in nude mice, but whether it acts as a viral oncogene *in vivo* is still unclear (Gao *et al.*, 1997). Only limited functional studies are presently available on the other IRF homologues encoded by ORFs K10, K10.I, K11.

D-type cyclin. Interfering with the control of the G₁ checkpoint of the cell cycle, controlled by D-type cyclins and the retinoblastoma protein pRb, appears to be a common theme for many tumour viruses (reviewed in Jansen-Dürr, 1996). With the exception of EHV-2, all rhadinoviruses (γ_2 herpesviruses) sequenced to date possess homologues to

D-type cyclins. EBV, a γ_1 herpesvirus does not have a cyclin homologue, but induces the expression of the human D2 cyclin via its EBNA-2 and EBNA-LP proteins (detailed references in Schulz *et al.*, 1998).

The KSHV v-cyclin (ORF 72) interacts with CDK6 and mediates phosphorylation on authentic sites of the retinoblastoma protein pRb, the physiological target of D-type cyclin/CDK complexes (Chang *et al.*, 1996; further detailed references in Schulz *et al.*, 1998). In SAOS-2 cells, which have homozygous deletions of both pRb and p53, KSHV v-cyclin prevents senescence induced by transfection of pRb and induces continuous proliferation (Chang *et al.*, 1996), and in 3T3 cells it promotes entry into the S phase of the cell cycle (Swanton *et al.*, 1997). Unlike cellular D-type cyclins, however, the v-cyclin/CDK6 complex is not susceptible to regulation by p21^{Cip1}, p27^{Kip1}, p16^{Ink4a} (Swanton *et al.*, 1997). It can also induce phosphorylation of H₁ histones, suggesting that it may be active in other phases of the cell cycle in addition to G1 (detailed references in Schulz *et al.*, 1998). Recent findings indicate that it can also mediate the phosphorylation, and thereby subsequent degradation, of p27^{Kip1}, thus mimicking the modulation of p27^{Kip1} levels normally carried out by ERK kinases or the cyclin E-cdk1 complex (Ellis *et al.* 1999). There is no evidence that the KSHV v-cyclin has transforming properties on its own. The mRNA encoding v-cyclin is expressed in KS spindle (endothelial tumour) cells and latently infected PEL cells lines (Davis *et al.*, 1997; Rainbow *et al.*, 1997; Savid *et al.*, 1998).

Latent nuclear antigen (LNA). ORF 73 encodes the high molecular weight (224–234 kDa) latent nuclear protein, LNA (Rainbow *et al.*, 1997), initially identified with patient sera on Western blots of nuclear extracts of the KSHV/EBV dually infected HBL-6 cell line (Gao *et al.*, 1996a). LNA represents the predominant component (possibly the only component) of the 'latency-associated nuclear antigen' (LANA), a characteristic nuclear 'speckled' staining pattern seen with sera from most KSHV-infected individuals (Gao *et al.*, 1996b; Kedes *et al.*, 1996) (Figure 2F.4; Plate III).

There are homologues of ORF 73 in other γ_2 herpesviruses (HVS, MHV 68, BHV-4, RRV), but the sequence homology between these proteins is low. KSHV LANA/ORF 73 has a long acidic repeat

region (Figure 2F.3) containing a leucine zipper motif at its carboxyl terminal end (Russo *et al.*, 1996). The length of this repeat region is variable, resulting in size variation of the ORF 73 protein among different isolates (Rainbow *et al.*, 1997). The ORF 73 protein is translated from a 6kb latent transcript which also includes the reading frames for ORF K13 (v-FLIP) and ORF 72 (v-cyc) and is expressed in KS spindle cells (Rainbow *et al.*, 1997; Sarid *et al.*, 1998) (Figure 2F.3). The function of the ORF 73 protein appears to include tethering KSHV episomal genomes to mitotic chromosomes thus ensuring their propagation during cell division (Ballestas *et al.*, 1999).

Untranslated RNAs. Like some other herpesviruses, KSHV encodes a nuclear RNA which does not appear to encode any protein (Zhong *et al.*, 1996). The T1.1/nut-1 RNA is polyadenylated, lacks a trimethylguanosine cap, is transcribed by RNA polymerase III and can associate with small ribonuclear proteins (Zhong and Ganem, 1997). In KS tumours it is expressed in a few tumour cells undergoing lytic replication (Staskus *et al.*, 1997) and is inducible in PEL cell lines in a pattern corresponding to an immediate-early or delayed early transcript (Zhong and Ganem, 1997; Sarid *et al.*, 1998; Sun *et al.*, 1998). In this respect it differs from non-coding nuclear RNAs encoded by EBV (EBERs), HVS (HSURs), HSV (LATs), which are all expressed during latency (and at reduced levels during lytic replication). T1.1/nut-1 may be involved in the control of splicing (Zhong and Ganem, 1997).

LATENT PERSISTENCE AND LYTIC REPLICATION

Like other herpesviruses (Chapters 2 and 2E), KSHV can persist in infected cells while expressing only a minimal set of 'latent' genes, or can undergo replication to produce new viral progeny. During 'latent' or 'persistent' infection, the viral genome exists as a circular episome which replicates independently of the host DNA. Circular episomes of KSHV DNA have been found in KS tumours and primary effusion lymphomas, indicating that, like other tumour viruses, KSHV persists in neoplastic cells in a latent form (Decker *et al.*, 1996). Unlike some other tumour viruses, KSHV is, however, not

Table 2F.1 KSHV genes which might play a role in pathogenesis

Viral Gene	Function	References
<i>Viral growth or chemotactic factors</i>		
v-MIP-I (ORF K6) ^b	Angiogenic properties (CAM); binds to CCR5; inhibits HIV-1 entry	Moore <i>et al.</i> (1996) Boshoff <i>et al.</i> (1997)
v-MIP-II (ORF K4) ^b	Angiogenic properties (CAM); binds to CCR3, CCR5, CXCR4, CCR1; chemotactic for eosinophils; inhibits monocyte chemotaxis; inhibits Ca influx	Boshoff <i>et al.</i> (1997) Kledal <i>et al.</i> (1997)
v-IL-6 ^b	Stimulates B cell proliferation; activates JAK/STAT phosphorylation	Moore <i>et al.</i> (1996) Nicholas <i>et al.</i> (1997b) Neipel <i>et al.</i> (1997) Molden <i>et al.</i> (1997)
<i>Viral inhibitors of apoptosis</i>		
v-bcl-2 (ORF K6) ^b	Inhibits bax-mediated apoptosis	Sarid <i>et al.</i> (1997)
v-FLIP (ORF 71/K13) ^a	Probably inhibits TNFR/Fas-mediated apoptosis	Thome <i>et al.</i> (1997) Bertin <i>et al.</i> (1997)
<i>Viral proteins affecting control of cellular proliferation</i>		
v-IRF (ORF K9) ^b	Inhibits γ interferon-mediated signalling; transforms rodent fibroblasts	Gao <i>et al.</i> (1997)
v-cyclin (ORF 72) ^a	Inactivates Rb protein; induces G1/S progression	Chang <i>et al.</i> (1996) Swanton <i>et al.</i> (1997) Ellis <i>et al.</i> (1999)
<i>Membrane proteins</i>		
v-GPCR (ORF 74)	Receptors for several chemokines, including IL-8; induces cellular proliferation; transforms fibroblasts and induces VEGF secretion	Arvanitakis <i>et al.</i> (1997) Bais <i>et al.</i> (1998)
Orf K1 protein	Transforms fibroblasts and T-cells	Lagunoff and Ganem (1997) Lee <i>et al.</i> (1998a,b)
Orf K15/LAMP ^b	Similarities to the transforming LMP-1 of EBV	Glenn <i>et al.</i> (1999) Poole <i>et al.</i> (1999)
<i>Others</i>		
LNA (ORF 73) ^a	Nuclear protein, required for episome maintenance	Rainbow <i>et al.</i> (1997) Ballestas <i>et al.</i> (1999)
'kaposin' (ORF K12) ^a	Putative hydrophobic protein Possible transforming properties	Zhong <i>et al.</i> (1996) Muralidhar <i>et al.</i> (1998)

^a Latent viral gene which is expressed in the majority of KS spindle cells.

^b Viral gene which is weakly expressed in latent PEL cells, but whose expression can be induced in these cells by treatment with phorbol esters or sodium butyrate. As far as the expression of these genes in KS tissue has been studied, they appear to be expressed only in lytically infected KS spindle cells or in infiltrating mononuclear cells. vIL-6 is also expressed in KSHV infected B lymphocytes in lymphoid tissue or MCD tissue *in vivo*. A more detailed discussion of these viral genes is given in the text.

strictly latent in KS tissue (see below). The expression pattern of individual viral genes has been studied mainly in PEL cell lines, which are more amenable to experimentation than KS tumour tissue. Three different patterns of expression can be distinguished (Sarid *et al.*, 1998). 'Class I' KSHV genes (Table 2F.1 and Figure 2F.3) are defined as

those genes which are expressed in PEL cell lines and whose expression is not increased by agents which induce lytic viral replication (e.g. some phorbol esters or sodium butyrate). At present there are at least four such genes: ORF K13 (v-FLIP), ORF 72 (v-cyclin), ORF 73 (LNA), and a 4.5 kb transcript of as yet unknown coding potential (Sarid *et al.*,

1998). Three of these, ORFs K13/v-FLIP, 72/v-cyc, 73/LANA are encoded next to each other, and translated from two alternatively spliced mRNAs controlled by the same latent promoter (Figure 2F.3; Dittmer *et al.*, 1998; Rainbow *et al.*, 1997; Sarid *et al.*, 1998). These three genes are also expressed in most KS spindle (endothelial tumour) cells and considered 'latent' genes.

A second set of KSHV genes ('class II' genes) is also, in most cases only weakly, expressed in PEL cell lines, but, unlike 'class I' genes, their expression is enhanced after induction of the lytic replication cycle. This class of genes include some, such as ORF K12 ('kaposin'), which are, like 'class I' genes, also strongly expressed in latently infected PEL cells and all KS spindle cells (Figure 2F.4; Plate III). The ORF K12 transcript (T 0.7) is in fact among the most abundant in KS tissue (Zhong *et al.*, 1996). While this transcript is therefore also a marker of latent infection, other 'class II' genes, such as the—also strongly expressed—untranslated nut-1/T1.1 RNA (Figure 2F.3) (Zhong *et al.*, 1996) are only seen in lytically infected cells in KS tissue by *in situ* hybridization (Staskus *et al.*, 1997).

Also among the 'class II' genes are the virus-encoded cytokines (v-IL-6, v-MIP-I, v-MIP-II, v-BCK/MIP) and the interferon regulatory factor (v-IRF/ORF K9), and the ORF K15/LAMP' transcript (Sarid *et al.*, 1998; Glenn *et al.*, 1999) (Figure 2F.3). As discussed above, some of these, e.g. v-IL-6, are expressed in KSHV-infected B cells *in vivo*, but do not appear to be expressed in KS spindle cells.

A third set of viral genes ('class III' genes) is expressed in PEL cell lines only after induction of the lytic replication cycle and comprises many conserved structural genes, but also some genes unique to KSHV, such as ORFs K1 and K8, K8.1 (Sarid *et al.*, 1998) (Figure 2F.3).

ANTIVIRAL THERAPY

In vitro, the replicative cycle of KSHV in PEL cell lines can be inhibited with ganciclovir, cidofovir and foscarnet, but not acyclovir (Kedes and Ganem, 1997; Medveczky *et al.*, 1997). *In vivo* treatment with ganciclovir or foscarnet reduced the rate of KS lesions developing in treated individuals in retrospective analyses (Glesby *et al.*, 1996; Mocroft *et al.*, 1996). No controlled prospective clinical trials to

assess the efficacy of these drugs has yet been reported. If their efficacy against KS *in vivo* can be substantiated, this would suggest that lytic KSHV replication, known to occur in a proportion of KS spindle cells and in some mononuclear cells infiltrating KS lesions (Orenstein *et al.*, 1997; Staskus *et al.*, 1997), plays an important role in the pathogenesis of KS. However, treatment of HIV with combination antiretroviral therapy is also very effective in some patients against AIDS KS, underlining the importance of HIV-1 replication as a cofactor in the pathogenesis of AIDS KS (Blum *et al.*, 1997; Conant *et al.*, 1997; and see below).

Different subtypes of KSHV

On the basis of two KSHV genomes, which have been sequenced completely (Russo *et al.*, 1996), or nearly completely (Neipel *et al.*, 1997), and several others which have been sequenced partially (Lagunoff and Ganem, 1997; Nicholas *et al.*, 1997a, 1998), it appears that only the two ends of the LUR exhibit significant sequence variability. An earlier study suggested the existence of three KSHV 'variants' or 'subtypes', termed A,B,C, by sequence analysis of the conserved ORF 26 and ORF 75 genes (Zong *et al.*, 1997). More recent efforts, based on the more variable K1 gene at the left end of the viral genome (Figure 2F.3), indicate the existence of four main groupings (Cook *et al.*, 1999; Zong *et al.*, 1999). Group B strains predominate in Africa, whereas group A and C strains are found in all parts of Europe and group D strains in Taiwan. The evolution of the K1 glycoprotein appears to be driven by some still unidentified selective pressure (Cook *et al.*, 1999; Zong *et al.*, 1999). At the right end of the viral genome, the presently available KSHV sequences appear to fall into two major groups, with a highly divergent primary sequence to the right of ORF 75 in the region of ORF K15/'LAMP' (Figure 2F.3) (Glenn *et al.*, 1999; Poole *et al.*, 1999). In contrast to ORF K1 these two variants of ORF K15LAMP' appear not to have evolved recently, and one of them may have originated from a recombination event with a closely related virus.

At present there is no evidence for the existence of KSHV variants with a different pathogenic potential. However, most of the longer KSHV sequences examined so far have been obtained from tumour

Table 2F.2 Serological assays for the detection of antibodies to KSHV/HHV-8

Antigen	Assay	Antibody detection rate (%)			References
		Classic KS	AIDS KS	Blood donors	
<i>Latent antigen</i> LANA (latency-associated nuclear antigen)	IFA	85–94	71–88	0–3 (UK/US)	Gao <i>et al.</i> (1996b) Kedes <i>et al.</i> (1996) Simpson <i>et al.</i> (1996) Lennette <i>et al.</i> (1996) Simpson <i>et al.</i> (1996) Calabrò <i>et al.</i> (1998) Whitby <i>et al.</i> (1998) Gao <i>et al.</i> (1996a)
ORF 73 protein (226/234 kDa nuclear protein; main component of LANA)	WB	100	80	0 (US)	Gao <i>et al.</i> (1996a)
<i>Structural (lytic) antigens</i> vp19 (ORF 65)	ELISA/WB	91	75–84	1.7–5 (UK/US)	Simpson <i>et al.</i> (1996) Calabrò <i>et al.</i> (1998)
40 kDa protein Gp35/37	WB ELISA/WB	approx. 90	67 approx. 80	9–22 (Italy, Greece) < 5	Miller <i>et al.</i> (1996) Raab <i>et al.</i> (1998) Chandran <i>et al.</i> (1998)
Whole cell	IFA	96–100	90–100	20–25 (US)	Lennette <i>et al.</i> (1996)
	ELISA/IFA		100	0–12 (US)	Ablashi <i>et al.</i> (1997)
	IFA		100	0 (US)	Chatlynne <i>et al.</i> (1998) Smith <i>et al.</i> (1997)

Antigens and assay formats used to detect antibodies to KSHV and approximate prevalence rates in patients with KS, and blood donors in different geographic regions. The range of values shown for Italy are due to marked regional variation of KSHV seroprevalence within Italy (Calabrò *et al.*, 1998; Whitby *et al.*, 1998), whereas the range of values reported by lytic IFA for US blood donors is likely due to differences in technical protocol (see text).

tissue, rather than from infected, healthy individuals, and only shorter variable regions such as ORF K1 have been compared between KS patients and infected healthy controls (Cook *et al.*, 1999). The existence of more pathogenic variants can therefore not yet be excluded.

ward *et al.*, 1997; Vieira *et al.*, 1997; further references in Schulz, 1998; Schulz *et al.*, 1998). To quantify the amount of KSHV DNA in peripheral blood, a quantitative competitive PCR assay has been developed (Lock *et al.*, 1997).

DIAGNOSTIC ASSAYS

Detection of KSHV DNA by PCR

By PCR, KSHV is easily detectable in fresh or frozen biopsies of KS, PEL or MCD, although the amount of KSHV DNA can be quite variable, in particular in KS biopsies. Detection in paraffin-embedded specimens may require the use of nested PCR, as does the detection in peripheral blood, saliva or semen, of KSHV-infected individuals with or without KS. Different primer combinations have been used successfully for this purpose (Chang *et al.*, 1994; Boshoff *et al.*, 1995; Whitby *et al.*, 1995; Ho-

Serological Assays

Several serological assays have been developed of varying sensitivity and specificity (Table 2F.2). With the help of these assays it has been possible to gain some insight into the epidemiology of KSHV (see below). However, their use in clinical practice, especially to diagnose infection with KSHV in an asymptomatic individual from a non-endemic country, is still associated with some uncertainty.

Sera from KSHV-infected individuals contain antibodies to proteins expressed in latently infected cells, as well as those produced during lytic viral replication. The main latent KSHV antigen, LNA, (Gao *et al.*, 1996a), is a 225–234 kDa nuclear protein

encoded by ORF 73 (Rainbow *et al.*, 1997). It is part of, if not identical with, LANA, originally defined by immunofluorescence (Gao *et al.*, 1996b; Kedes *et al.*, 1996). For routine testing of antibodies against this protein, an immunofluorescence assay (IFA) on latently infected PEL cell lines, such as BCP-1 (Gao *et al.*, 1996b) or BCBL-1 (Kedes *et al.*, 1996) is presently the most widely used technique, but assays based on recombinant proteins are under development. As shown in Table 2F.2, the LANA IFA detects antibodies in about 80–90% of KS patients and therefore has high, but not perfect, sensitivity. There is no homologue of ORF 73/LNA in EBV, a ubiquitous and related γ_1 herpesvirus (Russo *et al.*, 1996). Furthermore, in countries where infection with KSHV appears to be rare, such as the UK, only 0–3% of blood donors react with this antigen. This suggests that ORF 73/LNA is a highly specific serological antigen. At present there is still considerable interlaboratory variation with LANA IFAs (Rabkin *et al.* (1998); detailed references in Schulz, 1998; 1999). Although other latent viral proteins exist, none has so far found a diagnostic application.

As for other herpesviruses, many proteins expressed during the lytic cycle of viral replication are immunogenic and recognized by antibodies in patient sera (Miller *et al.*, 1996; Simpson *et al.*, 1996; Smith *et al.*, 1997; Raab *et al.*, 1998). The lytic replication cycle of KSHV can be induced in latently infected PEL cell lines by treatment with phorbol esters or butyrate, and such 'induced' cells have been used for immunofluorescence using different experimental conditions (Lennette *et al.*, 1996; Ablashi *et al.*, 1997; Smith *et al.*, 1997; Figure 2F.5). These lytic IFAs have been reported to detect antibodies in a higher proportion of KS patients than LANA IFA. However, presumably as a result of using different experimental conditions, variable seroprevalence rates have been reported with lytic IFAs for US blood donors (Lennette *et al.*, 1996; Smith *et al.*, 1997; Chatlynne *et al.*, 1998; further references in Schulz, 1998, 1999). Some of the structural proteins of KSHV have relatively high homology to the corresponding EBV proteins (Russo *et al.*, 1996), and serological cross-reactivity between the major capsid proteins of both viruses may occur (references in Schulz *et al.*, 1998). Therefore it will be important to establish the best conditions for lytic IFAs to allow results to be reproducible in different laboratories. An ELISA using purified KSHV

virions as antigen has also been reported (Chatlynne *et al.*, 1998).

In an attempt to circumvent these difficulties, several groups have investigated the use of recombinant structural proteins, concentrating either on those with low homology to the corresponding EBV proteins, or on proteins without a counterpart in the EBV genome. At present, only two recombinant structural proteins appear to hold any promise. The minor capsid-related protein encoded by ORF 65 (Simpson *et al.*, 1996) gives a sensitivity of 80–90%, while reacting with a slightly higher proportion of UK blood donors than detected by LANA immunofluorescence (Table 2F.2). It detects some KS sera that are missed by LANA IFA and the two assays can therefore be used in combination to increase the sensitivity (Simpson *et al.*, 1996). The glycoprotein encoded by ORF K8.1 does not have a counterpart in the EBV genome and is also recognized by the majority of KS sera, but only rarely by US and northern European blood donor sera (Chandran *et al.*, 1998; Raab *et al.*, 1998).

In contrast, recombinant proteins or peptides derived from a minor capsid protein encoded by ORF 26, or the major capsid protein (ORF 25), do not discriminate well enough between sera from KS patients and blood donors to be used for routine serology (Rabkin *et al.*, 1998; and further references in Schulz, 1998, 1999).

EPIDEMIOLOGY OF KSHV

Geographical distribution

The distribution of KSHV among asymptomatic individuals from different geographical regions has been studied by PCR and the serological assays available at present. Both approaches suggest that KSHV is more common in some Mediterranean countries and in parts of Africa than in northern Europe or the US, and that there may be marked regional differences in KSHV prevalence even within countries. Although the exact prevalence rates are still uncertain, KSHV appears to be more common in those countries which were known to have higher incidence rates for classical KS.

By PCR, KSHV has been detected in peripheral blood mononuclear cells (PBMCs) or semen samples from asymptomatic donors in northeastern Italy and Sicily, but not in northwestern Italy,

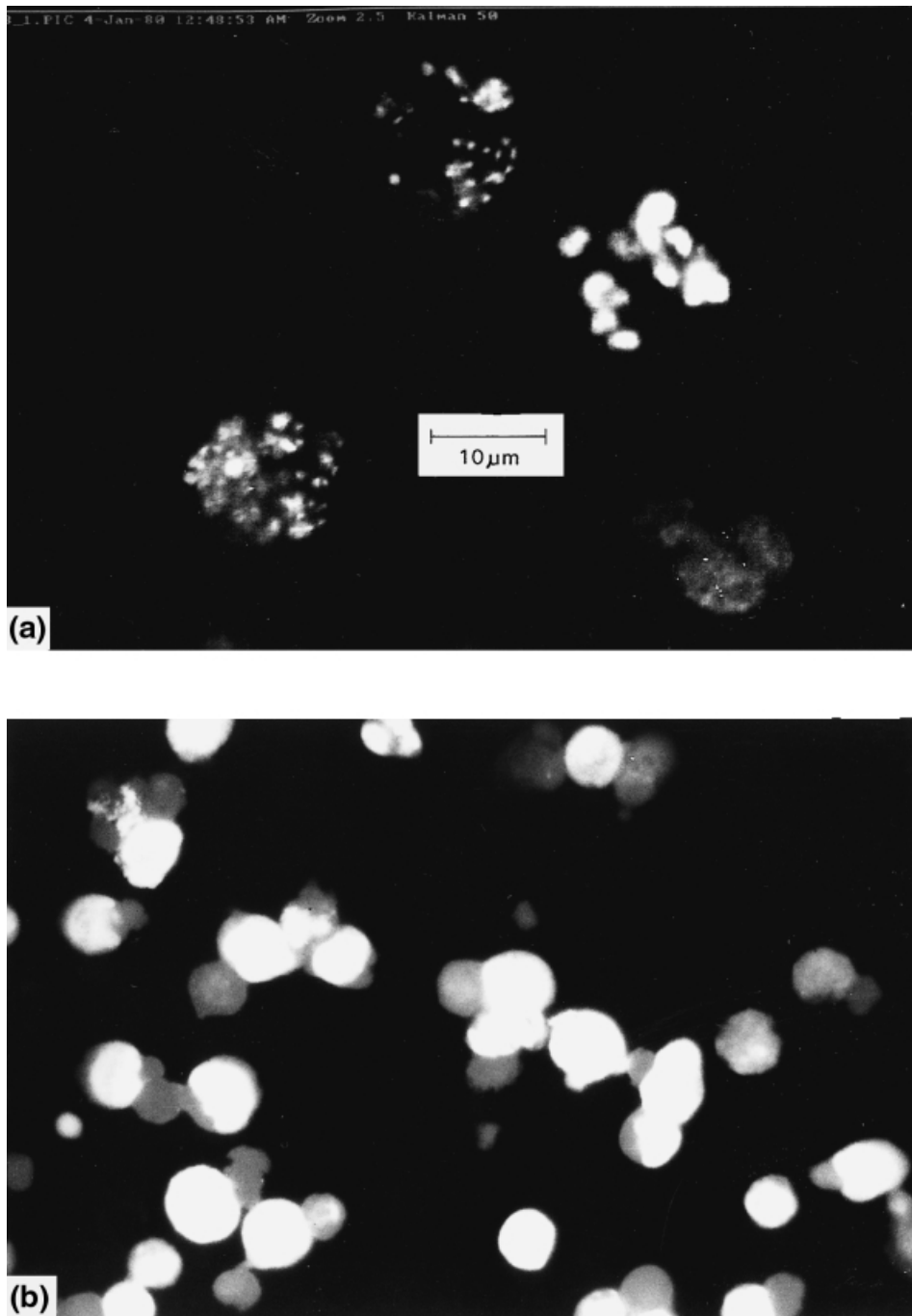

Figure 2F.5 Immunofluorescence pattern for (a) latent and (b) lytic KSHV antigens in PEL cells. (a) shows the characteristic speckled nuclear pattern for the 'latency associated nuclear antigen', LANA (Gao *et al.*, 1996b; Kedes *et al.*, 1996), which is encoded by ORF73 (Rainbow *et al.*, 1997). (b) shows the diffuse nuclear and cytoplasmic fluorescence seen on TPA- or Na-butyrate-induced PEL cells with patient sera. Only a few of the viral proteins contributing to this pattern have so far been identified (see text)

France or the UK (detailed references in Blackburn and Levy, 1997; Schulz, 1998, 1999). KSHV has occasionally been found in PBMCs, but not reproducibly in semen samples, from healthy US donors. In The Gambia, West Africa, KSHV has been detected by PCR in the peripheral blood of 10% of HIV-negative antenatal mothers. In Zambia, it was found in the peripheral blood of 8% of young febrile children, and in Uganda in 14% of adult controls with tumours other than KS (detailed references in Schulz, 1998, 1999). PCR carried out on PBMCs, underestimates the number of KSHV-infected individuals because of the low viral load in peripheral blood (see below). These results therefore indicate only the presence of KSHV in healthy individuals of these countries, but cannot be used to infer the exact prevalence of KSHV infection.

The seroprevalence of KSHV in different geographic regions has been studied using the LANA IFA, an ORF 65 ELISA and Western blot, as well as lytic IFAs (Gao *et al.*, 1996b; Lennette *et al.*, 1996; Simpson *et al.*, 1996; Calabrò *et al.*, 1998; Whitby *et al.*, 1998; further references in Schulz, 1998, 1999) (Figure 2F.5). Like PCR, serology also suggests that KSHV is relatively rare in the UK, Denmark, France and The Netherlands, with less than 5% of blood donors having antibodies to either KSHV LANA or the ORF 65 protein. In the US, reported prevalence rates in blood donors have varied from 0 to 3% for antibodies to LANA, 0 to 5% for antibodies to the ORF 65 protein, and 0 to 25% for antibodies measured by lytic IFA or an ELISA on purified virions (Gao *et al.*, 1996b; Kedes *et al.*, 1996; Lennette *et al.*, 1996; Simpson *et al.*, 1996; Smith *et al.*, 1997; Chandran *et al.*, 1998; Chatlynne *et al.*, 1998; further references in Schulz, 1998, 1999). As there is considerable variability not only between assays, but also between laboratories undertaking the same assay with slightly different protocols (Rabkin *et al.*, 1998), these figures only give a rough indication as to the exact prevalence rates in these 'non-endemic' countries. Of note, only very few donors in non-endemic countries have antibodies which react in more than one assay, adding to the current uncertainty about the exact KSHV prevalence in these countries.

In contrast, all studies reported so far concur that antibodies to KSHV are frequently found in several parts of Africa. Antibodies to LANA and ORF 65 are found in approximately 40–50% of adults and adolescents in most parts of sub-Saharan Africa

investigated so far, e.g. Uganda, Tanzania, The Gambia, Cameroon, South Africa (Gao *et al.*, 1996b; Lennette *et al.*, 1996; Simpson *et al.*, 1996; Ariyoshi *et al.*, 1998; Mayama *et al.*, 1998; further references in Schulz, 1998, 1999). By IFA, antibodies to lytic KSHV antigens have been found in 30–100% of sera from different parts of Africa (Lennette *et al.*, 1996). These high seroprevalence rates, obtained with assays which detect antibodies to defined antigens, suggest that KSHV is widespread in Africa, and occurs not only in those regions (East and Central Africa) where KS was known to exist before the arrival of HIV-1 (endemic KS) (see below). This could suggest an involvement of additional cofactors in the pathogenesis of endemic KS (see below).

Although less frequent than in Africa, infection with KSHV also appears to be widespread in Italy and Greece (Gao *et al.*, 1996b; Simpson *et al.*, 1996; Calabrò *et al.*, 1998; Whitby *et al.*, 1998; further references in Schulz, 1998, 1999). Unlike in the 'non-endemic' countries discussed above, approximately 13% of all Italian blood donors were found to have antibodies to both KSHV LANA and the ORF 65 protein, and 24% had antibodies to at least one of these antigens (Calabrò *et al.*, 1998) (Figure 2F.6). It is likely that the 'true' prevalence of KSHV is closer to the latter figure. In Italy, infection with KSHV appears to be more common among blood donors from regions previously reported to have a higher incidence of classic KS, such as Sicily, Sardinia, than in central Italy or in prealpine regions (Calabrò *et al.*, 1998; Whitby *et al.*, 1998; further references in Schulz, 1998, 1999). KSHV seroprevalence is increased markedly in blood donors aged over 50, i.e. the age group in which the incidence of classic KS is highest (Calabrò *et al.*, 1998). Whether this reflects a higher rate of infection among individuals born > 50 years ago, or a reactivation of KSHV replication in older age, is unclear at present.

Thus, the increased prevalence of KSHV infection in some Mediterranean countries is in accordance with their higher incidence of classical KS. In Africa, KSHV appears at the present time to be highly prevalent in the East, West and South, whereas 'endemic' (HIV-negative African) KS is confined to East and Central Africa. The geographic distribution of KSHV in Africa therefore agrees partially with that expected for the 'KS agent', suggesting an involvement of cofactors in KS pathogenesis (see below).

Distribution in Individuals at Risk for HIV Transmission

In accordance with the high incidence of acquired immune deficiency syndrome (AIDS) KS in HIV-infected homosexual/bisexual men, KSHV appears to be common in this group. As ascertained by the presence of antibodies to LANA/ORF 73 and ORF 65 encoded capsid protein, about a third of homosexual men participating in cohort studies in Denmark, the UK and Holland were infected with KSHV (Simpson *et al.*, 1996; Melbye *et al.*, 1998; Renwick *et al.*, 1998). In contrast, KSHV is not more common in HIV-infected intravenous drug users and patients with haemophilia than in blood donor populations of the same country (Simpson *et al.*, 1996; Calabrò *et al.*, 1998), which is again in accordance with the lower frequency of AIDS KS in these individuals (Figure 2F.6).

Transmission

Some of the initial scepticism that KSHV should be the infectious cause of KS was based on the expectation that a herpesvirus would spread rapidly among children or adolescents and thus be unlikely to follow the pattern of sexual transmission postulated for the 'KS agent' (reviewed in Schulz and Weiss, 1995). Recent seroepidemiological studies have resolved this apparent conundrum.

In 'non-endemic' countries (e.g. UK, USA, Denmark, The Netherlands, France) transmission of KSHV as a result of frequent sexual contacts appears to play an important role among homosexual men and to be associated with 'high-risk' sexual behaviour. Thus antibodies to KSHV are more common among UK and US attendees at sexually transmitted disease clinics and homosexual men than among blood donors (Simpson *et al.*, 1996; Kedes *et al.*, 1996) (Figure 2F.6). Among homosexual men, infection with KSHV is increased by promiscuity, duration of homosexual lifestyle, (in one study) the presence of other STDs, and (in one study) receptive anal intercourse (Martin *et al.*, 1998; Melbye *et al.*, 1998). Oral-penile contact emerged as a risk factor for KSHV transmission in another cohort study (Dukers *et al.*, 1999). Contact with the US homosexual milieu in the early 1980s (where KS was very common) also predisposed to infection with KSHV (Melbye *et al.*, 1998).

These seroepidemiological studies indicate that KSHV transmission among homo/bisexual men is facilitated by the same risk factors previously known to increase the risk for AIDS KS in this group. Whether KSHV is transmitted via semen is not entirely clear. KSHV has been detected only infrequently by PCR in semen samples from KS patients in northern Europe and the US, and in asymptomatic Italian semen donors (see above) and it is not known whether these quantities represent an infectious dose. KSHV has also been detected in saliva (Vieira *et al.*, 1997), and one cohort study revealed oral-penile contact as a risk factor among homosexual men (Dukers *et al.*, 1999). It is thus conceivable that saliva could also represent an important vehicle for KSHV transmission.

In contrast, in endemic African countries KSHV is mainly transmitted among children before the age of puberty (Mayama *et al.*, 1998). These studies suggest a pattern of horizontal transmission similar to that of other herpesviruses, such as EBV, HSV-1 and HHV-6 (Chapters 2D, 2A and 2E) perhaps within families from mother to child, or child to child (Bourboulija *et al.*, 1998; Mayama *et al.*, 1998). Infectious KSHV has been cultured from saliva (Vieira *et al.*, 1997) and it is thus likely that, as for EBV, horizontal transmission of KSHV via saliva can occur. In contrast, infection with KSHV in US children appears to occur mainly after puberty (Blauvelt *et al.*, 1997).

Parenteral transmission of KSHV by blood transfusion has been documented in one case. However, the prevalence of antibodies to KSHV among intravenous drug users in a 'non-endemic' country (UK), and an 'endemic' country (Italy), is the same as for blood donors from these countries (Simpson *et al.*, 1996; Calabrò *et al.*, 1998), suggesting that parenteral transmission does not contribute significantly to the spread of KSHV. In addition, KS has always been known to be rare among those who contracted HIV via contaminated blood.

Transmission of KSHV through organ or bone marrow transplantation may occur (Regamey *et al.*, 1998). However, in endemic countries it appears that the majority of individuals who developed post-transplant KS were already infected with KSHV at the time of transplantation, rather than being infected through the transplanted organ (Paravicini *et al.*, 1997; Farge *et al.*, 1999; further references in Schulz *et al.*, 1998, 1999). To what extent this also applies in non-endemic countries, and whether there is therefore a need to screen organ or

bone marrow donors, or blood to be transfused to immunosuppressed individuals in non-endemic countries, is still under investigation.

ROLE OF KSHV IN NEOPLASTIC DISEASE

Kaposi's Sarcoma

Since the discovery of two KSHV DNA fragments in a case of AIDS-associated KS (Chang *et al.*, 1994), many groups have reported that KSHV genomes can be detected, by Southern blot or PCR, in all epidemiological forms (HIV-associated, 'classic', endemic) and clinical stages (early patch/plaque, fully developed nodular) of KS (see Schulz, 1998, 1999; Schulz *et al.*, 1998 for detailed references). By nested PCR KSHV can also be detected in non-involved tissue from KS patients, including in skin, lymphoid tissue, prostate, semen, PMBCs (for example, Whitby *et al.*, 1995; Howard *et al.*, 1997; further references in Schulz, 1998; Schulz *et al.*, 1998). Detection of KSHV is possible in PMBCs of 50–60% of patients with HIV-associated or 'classic' KS, but not, or only infrequently, in HIV-negative individuals from non-endemic areas (for example, Whitby *et al.*, 1995; for further references see Schulz, 1998, 1999). In addition, detection of KSHV in PMBCs of HIV-infected individuals predicts the subsequent appearance of KS lesions (Whitby *et al.*, 1995; and further references in Schulz, 1998). The presence of antibodies to KSHV in non-endemic areas is also strongly associated with having KS, or being at increased risk for KS, and, among HIV-1 infected individuals, is strongly predictive of the subsequent appearance of KS lesions (Gao, *et al.*, 1996a, 1996b; Keddes *et al.*, 1996; Simpson *et al.*, 1996; Martin *et al.*, 1998; Renwick *et al.*, 1998; Sitas *et al.*, 1999). In particular, KSHV antibodies are found frequently among HIV-infected homosexual/bisexual men, who are known to be at increased risk for KS, but only very rarely in HIV-infected patients with haemophilia and intravenous drug users, who are not (Figure 2F.6).

Since the amount of KSHV DNA in KS lesions can vary, and since cell cultures and immortalized cell lines established from KS biopsies lack KSHV DNA after a few passages, it appeared initially possible that KSHV might be a mere passenger in KS

lesions. This concern receded when, by PCR *in situ* hybridization, KSHV genomes were first detected in spindle cells, the presumed neoplastic component of KS lesions (Bolshoff *et al.*, 1995). Further studies confirmed this and demonstrated the presence of KSHV genomes in the endothelial cells of early KS lesions (references in Schulz, 1998; Schulz *et al.*, 1998). When latent viral genes (ORFs K12/'kaposin'; ORF K13/v-FLIP; ORF 72/v-cyclin; ORF 73/LANA) were found to be expressed in these cells (Plate III) KSHV appeared to behave very much like other oncogenic viruses that establish a latent infection in transformed cells (Rainbow *et al.*, 1997; Staskus *et al.*, 1997; Stürzl *et al.*, 1997; Dupin *et al.*, 1999; further references in Schulz, 1998). KS biopsies contain mainly circular episomal viral DNA, which is consistent with the latent infection (see above). However, some spindle cells in KS lesions can undergo lytic replication of KSHV (Orenstein *et al.*, 1997; Staskus *et al.*, 1997), and unlike many other oncogenic viruses, KSHV therefore is not strictly latent in neoplastic cells. This propensity to switch into lytic replication may explain why cell cultures established from KS lesions lose KSHV after a few passages (reviewed in Schulz *et al.*, 1998). Whether, in addition to latent genes, some of the viral genes expressed during lytic replication may therefore play a role in the pathogenesis of KS is presently under intense investigation.

The precise contribution of the viral genes summarized in Table 2F.1 to the pathogenesis of KS is not yet resolved. KSHV clearly has the capacity to interfere with the control of cellular proliferation, such as cell cycle control (v-cyc/ORF 72), apoptosis (v-FLIP/ORF 71; v-bcl-2/ORF 16), intracellular signal transduction (v-IL-6/ORF K2; v-IRF/ORF K9), and some of its proteins have chemotactic and/or angiogenic properties (v-MIPs). Four viral proteins (v-IRF, v-GCR, ORF K1 protein, ORF K12/'kaposin') may have transforming properties *in vitro*, when placed under the control of a strong promoter. Recent findings also indicate that KSHV may be able to transform endothelial cells *in vitro*, and that this may involve paracrine mechanisms (Flore *et al.*, 1998). It will be important to investigate the contribution of individual viral genes to the transformation of endothelial cells in the context of the whole viral genome, as has been possible for EBV. Studies of this kind are presently hampered by the lack of a suitable *in vitro* culture system and an animal model.

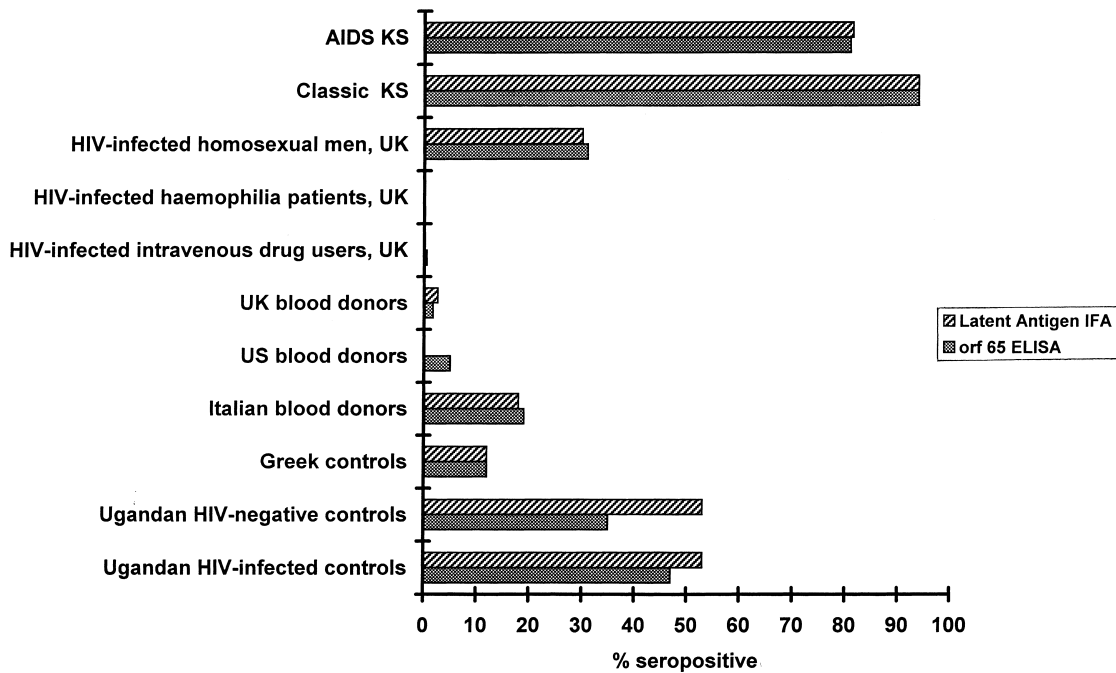

Figure 2F.6 Seroprevalence of KSHV in different countries and HIV transmission groups. Seroprevalence rates for KSHV, as measured by antibodies to LANA (IFA) and to vp16/ORF65 (ELISA/WB) by Simpson *et al.* (1996) and Calabrò *et al.* (1998) are shown. As discussed in the text, and illustrated in Table 2F.2, somewhat higher prevalence rates have been found in American blood donors with an IFA on lytically infected cells by some (Lennette *et al.*, 1996), but not others (Smith *et al.*, 1997; Chandran *et al.*, 1998; Chatlynne *et al.*, 1998). However, the overall rank order of seroprevalence, from low in the UK/USA, to intermediate in some Mediterranean countries, to high in several parts of Africa, is supported by all studies

Additional Cofactors Required for the Development of KS?

A number of epidemiological observations suggest that additional cofactors may be required in addition to KSHV for the development of KS. KSHV seroprevalence rates of 20–35% in Italy, and approximately 20% in Greece (see above and Table 2F.2; Fig. 2F.6), when compared to the population based incidence rates of 1–3/100 000 for ‘classic’ KS in these regions, suggest that the development of KS is a rare event in a KSHV-infected individual who is not infected with HIV or otherwise immunosuppressed. In contrast, AIDS-associated KS appears to be relatively common among homosexual men infected with HIV-1 and KSHV. Of note, AIDS-associated KS is not more common among HIV-infected intravenous drug users and patients with haemophilia from Italy compared to the UK, in spite of the marked difference in KSHV serop-

revalence in these two countries (Calabrò *et al.*, 1998). In the Gambia, West Africa, AIDS KS is markedly more common among HIV-1-infected than among HIV-2-infected individuals, although the KSHV prevalence appears to be comparable in these two groups (Ariyoshi *et al.*, 1998). These observations suggest that infection with HIV-1 represents an important cofactor. Although KS is more common in transplant recipients, and therefore related to immunosuppression, the role of HIV-1 infection may go beyond that, since KS in HIV-2-infected individuals is comparatively rare (Ariyoshi *et al.*, 1998), and some AIDS KS lesions can respond rapidly to antiretroviral therapy (Blum *et al.*, 1997; Conant *et al.*, 1997). An angiogenic role for the HIV-1 Tat protein or inflammatory cytokines released during HIV infection has been suggested, and an induction of KSHV replication by HIV-1 Tat protein claimed (detailed references in Biberfeld *et al.*, 1998; Schulz, 1998), but such a link has not yet

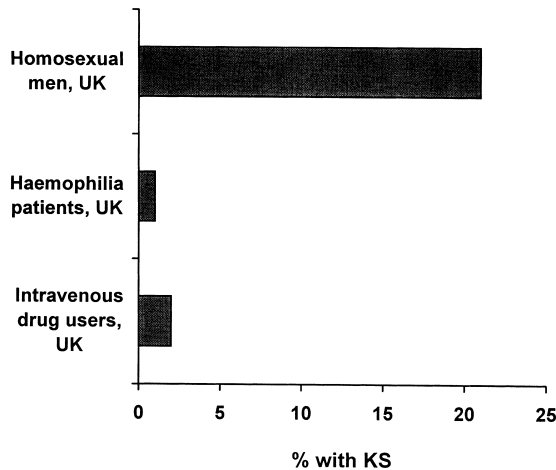

Figure 2F.7 Proportion of UK AIDS patients of different transmission groups who develop KS. KS is common in homosexual/bisexual men, but infrequent among intravenous drug users, patients with haemophilia, or heterosexually infected women. Detailed data and references in *IARC Monographs on the Evaluation of Carcinogenic Risks to Humans*, vol. 67: Human Immunodeficiency Viruses. IARC Press, 1996

been established clearly.

Primary Effusion Lymphoma (PEL)

KSHV genomes are also found consistently in PEL, also termed 'body-cavity associated lymphoma' (BCBL) (for example, Cesarman *et al.*, 1995; further references in Schulz, 1998), a rare form of AIDS-related B cell lymphoma which is characterized by malignant effusions in the pleural or abdominal cavity, immunoglobulin gene rearrangement, lack of most surface markers and, unlike Burkitt's lymphoma, a lack of c-myc rearrangements (for a review, see Jaffe, 1996). Many cases of PEL are dually infected with EBV and KSHV (Cesarman *et al.*, 1995), but occasional cases of EBV-negative/KSHV-positive PEL have been reported (Renne *et al.*, 1996; Said *et al.*, 1996). A few cases of PEL have also been described in HIV-negative patients (detailed references in Schulz, 1998; Schulz *et al.*, 1998).

PEL lymphoma cells, and the cell lines established from them (see above), harbour multiple (approximately 50–100) copies of KSHV as episomes (Cesarman *et al.*, 1995a; Renne *et al.*, 1996; Said *et al.*, 1996), as is typical for latent herpes viral infection. As in the case of KS spindle cells, a minority of cells in a PEL cell line culture can undergo lytic

replication (see above).

The four latent genes expressed in KS spindle cells (ORF K12/'kaposin'; ORF K13/v-FLIP, ORF 72/v-cyc, ORF 73/LANA; see above) are also expressed in PEL cells, as is a fourth, so far unmapped, transcript (Rainbow *et al.*, 1997; Sarid *et al.*, 1998). In addition, PEL cell lines show some basal expression of v-IL-6, MIP-I, MIP-II and v-IRF (ORF K9) and a non-translated nuclear RNA T1.1/nut-1 (Moore *et al.*, 1996; Zhong *et al.*, 1996). By immunohistochemistry, PEL cells and KSHV infected B cells in lymphatic tissue, but not KS spindle cells, express v-IL-6, an inducible gene (Moore *et al.*, 1996). There are thus some well-documented differences in gene expression between KS spindle cells and KSHV-infected B cells, and further differences are likely to be found in the future.

Multicentric Castleman's Disease (MCD)

Multicentric Castleman's disease is an atypical lymphoproliferative disorder which occurs in two histological variants, the hyaline-vascular variant and the plasma cell variant. Most cases of MCD in HIV-infected patients, in particular the plasma cell variant, contain detectable KSHV. In contrast, KSHV is much less frequently detected in MCD of HIV-negative patients (Soulier *et al.*, 1995; further references in Schulz, 1998; Schulz *et al.*, 1998). The precise role of KSHV in the pathogenesis of MCD is thus not yet clear. However, v-IL-6 is expressed in B cells in these lesions and, on the basis of its *in vitro* properties (see above), is likely to contribute to the proliferation of KSHV infected B cells in these lesions.

Other Lymphoproliferative Disease

KSHV has been detected in occasional cases of HIV-negative angioimmunoblastic lymphadenopathy and germinal centre hyperplasia (Luppi *et al.*, 1996). Histologically, there may be prominent plasma cell proliferation and angiogenic changes in these cases, suggesting that viral proteins like v-IL-6 and v-MIP-I/II may have induced these transient changes.

KSHV and its IL-6 homologue have also been claimed to play a role in the pathogenesis of

multiple myeloma and benign monoclonal gammopathy (Rettig *et al.*, 1997), but recent sero-epidemiological and PCR-based studies do not support this (MacKenzie *et al.*, 1997; further references in Schulz *et al.*, 1998).

Similarly, KSHV DNA has been reported to be present in a variety of other lymphoid and non-lymphoid neoplasias, as well as in sarcoidosis, but others have so far not been able to corroborate these claims.

REFERENCES

- Ablashi, D.V., Chatlynne, L.G., Lapps, W. *et al.* (1997) Human herpesvirus 8 (HHV8): epidemiology and characterisation of virus from KS-1 cell line. *Journal of Acquired Immune Deficiency Syndromes and Human Retrovirology*, **14**, A23.
- Ariyoshi, K., Schim van der Loeff, M., Corrah, T. *et al.* (1998) Kaposi's sarcoma and human herpesvirus 8 (HHV8) in HHV-1 and HHV-2 infection in The Gambia. *Journal of Human Virology*, **1**, 193–199.
- Arvantakis, L., Geras, R.E., Varma, A. *et al.* (1997) Human herpesvirus KSHV encodes a constitutively active G-protein-coupled receptor linked to cell proliferation. *Nature*, **385**, 347–350.
- Bais, C., Santomaso, B., Coso, O. *et al.* (1998) G-protein coupled receptor of Kaposi's sarcoma-associated herpesvirus is a viral oncogene and angiogenesis activator. *Nature*, **341**, 86–89.
- Ballestas, M.E., Chatis, P.A., Kaye, K.H. (1999) Efficient persistence of extrachromosomal KSHV DNA mediated by latency associated nuclear antigen. *Science*, **284**, 641–644.
- Bertin, J., Armstrong, R.C., Otilie, S. *et al.* (1997) Death effector domain-containing herpesvirus and poxvirus proteins inhibit both Fas- and TNFR1-induced apoptosis. *Proceedings of the National Academy of Sciences of the USA*, **94**, 1172–1176.
- Biberfeld, P., Ensoli, B., Stürzl, M. *et al.* (1998) Kaposi sarcoma-associated herpesvirus/human herpesvirus 8, cytokines, growth factors and HIV in the pathogenesis of Kaposi's sarcoma. *Current Opinion in Infectious Diseases*, **11**, 97–105.
- Blackbourn, D.J. and Levy, J.A. (1997) Human herpesvirus 8 in semen and prostate. *AIDS*, **11**, 249–250.
- Blauvelt, A., Sei, S., Cook, P.M. *et al.* (1997) Human herpesvirus 8 infection occurs following adolescence in the United States. *Journal of Infectious Diseases*, **176**, 771–774.
- Blum, L., Pellet, C., Agbalika, F. *et al.* (1997) Complete remission of AIDS-related Kaposi's sarcoma associated with undetectable human herpesvirus-8 sequences during anti-HIV protease therapy. *AIDS*, **11**, 1653–1655.
- Bshoff, C., Schulz, T.F., Kennedy, M.M. *et al.* (1995) Kaposi's sarcoma associated herpesvirus infects endothelial and spindle cells. *Nature Medicine*, **1**, 1274–1278.
- Bshoff, C., Endo, Y., Collins, P.D. *et al.* (1997) Angiogenic and HIV-inhibitory functions of KSHV-encoded chemokines. *Science*, **278**, 290–294.
- Bourbouliou, D., Whitby, D., Bshoff, C., *et al.* (1998) Serologic evidence for mother-to-child transmission of Kaposi's sarcoma-associated herpesvirus infection. *Journal of the American Medical Association*, **280**, 31–32.
- Calabrò, M.L., Sheldon, J., Favro, A. *et al.* (1998) Seroprevalence of Kaposi's sarcoma-associated herpesvirus (KSHV/HHV8) in different regions of Italy. *Journal of Human Virology*, **1**, 207–213.
- Cesarman, E., Chang, Y., Moore, P.S. *et al.* (1995) Kaposi's sarcoma-associated herpesvirus-like DNA sequences in AIDS-related body-cavity-based lymphomas. *New England Journal of Medicine*, **332**, 1186–1191.
- Chandran, B., Smith, M.S., Koelle, D.M. *et al.* (1998) Reactivities of human sera with human herpesvirus-8-infected BCBL-1 cells and identification of HHV-8-specific proteins and glycoproteins and the encoding cDNAs. *Virology*, **243**, 208–217.
- Chang, Y., Cesarman, E., Pessin, M.S. *et al.* (1994) Identification of herpesvirus-like DNA sequences in AIDS-associated Kaposi's sarcoma. *Science*, **266**, 1865–1869.
- Chang, Y., Moore, P.S., Talbot, S.J. *et al.* (1996) Cyclin encoded by KS herpesvirus. *Nature*, **382**, 410.
- Chatlynne, L.G., Lapps, W., Handy, M. *et al.* (1998) Detection and titration of human herpesvirus-8-specific antibodies in sera from blood donors, acquired immunodeficiency syndrome patients, and Kaposi's sarcoma patients using a whole virus enzyme-linked immunosorbent assay. *Blood*, **92**, 53–58.
- Conant, M.A., Opp, K.M., Poretz, D. *et al.* (1997) Reduction of Kaposi's sarcoma lesions following treatment of AIDS with zidovudine. *AIDS*, **11**, 1300–1301.
- Cook, P.M., Whitby, D., Calabrò, M.L. *et al.* (1999) Variability and evolution of the K1 gene of Kaposi's sarcoma-associated herpesvirus in different geographic regions of Europe and Africa (submitted).
- Davis, M.A., Stürzl, M., Blasig, C. *et al.* (1997) Expression of human herpesvirus 8-encoded cyclin D in Kaposi's sarcoma spindle cells. *Journal of the National Cancer Institute*, **89**, 1868–1874.
- Decker, L.L., Shankar, P. and Khan, G. (1996) The Kaposi sarcoma-associated herpesvirus (KSHV) is present as an intact latent genome in KS tissue but replicates in the peripheral blood mononuclear cells of KS patients. *Journal of Experimental Medicine*, **184**, 283–288.
- Desrosiers, R.C., Sasseville, V.G., Czajak, S.C. *et al.* (1997) A herpesvirus of rhesus monkeys related to the human Kaposi's sarcoma-associated herpesvirus. *Journal of Virology*, **71**, 9764–9769.
- Dittmer, D., Lagunoff, M., Renne, R. *et al.* (1998) A cluster of latently expressed genes in Kaposi's sarcoma-associated herpesvirus. *Journal of Virology*, **72**, 8309–8315.
- Dukers, N.H.T.M., Renwick, N., Prins, M. *et al.* (1999) Risk factors for HHV8 seropositivity and HHV8 seroconversion in a cohort of homosexual men. *American Journal of Epidemiology* (in press).
- Dupin, N., Fisher, C., Kellam, P., *et al.* (1999) Distribution of human herpesvirus-8 latently infected cells in Kaposi's sarcoma, multicentric Castleman's disease, and primary effusion lymphoma. *Proceedings of the National Academy of Sciences of the USA*, **96**, 4546–4551.
- Ellis, M., Chew, Y.P., Fallis, L., *et al.* (1999) Degradation of p27^{kip} cdk inhibitor triggered by Kaposi's sarcoma virus cyclin-cdk6 complex. *EMBO Journal*, **18**, 644–653.
- Farge, D., Lebbé, C., Marjanovic, Z. *et al.* (1999) Human herpesvirus 8 (HHV 8) and other risk factors for Kaposi's sarcoma in kidney transplant recipients. *Transplantation*, **67**, 1236–1242.
- Flore, O., Rafii, S., Ely, S. *et al.* (1998) Transformation of primary endothelial cells by Kaposi's sarcoma-associated herpesvirus.

- Nature*, **394**, 588–592.
- Foreman, K.E., Friborg, J., Kong, W.-P. *et al.* (1997) Propagation of a human herpesvirus from AIDS-associated Kaposi's sarcoma. *New England Journal of Medicine*, **336**, 163–171.
- Gao, S.J., Kingsley, L., Hoover, D.R. *et al.* (1996a) Seroconversion of antibodies to Kaposi's sarcoma-associated herpesvirus-related latent nuclear antigens before the development of Kaposi's sarcoma. *New England Journal of Medicine*, **335**, 233–241.
- Gao, S.J., Kingsley, L., Li, M. *et al.* (1996b) Seroprevalence of KSHV antibodies among North Americans, Italians, and Ugandans with and without Kaposi's sarcoma. *Nature Medicine*, **2**, 925–928.
- Gao, S.J., Boshoff, C., Hayachandra, S. *et al.* (1997) KSHV *orfK9* (vIRF) is an oncogene which inhibits the interferon signaling pathway. *Oncogene*, **15**, 1979–1985.
- Glenn, M.A., Rainbow, L., Auradé, F. *et al.* (1999) Identification of a spliced KSHV/HHV8 gene that encodes a protein with similarities to latent membrane proteins 1 and 2A of Epstein–Barr virus. *Journal of Virology*, **73**, 6953–6963.
- Glesby, M.J., Hoover, D.R., Weng, S. *et al.* (1996) Use of anti-herpes drug and risk of Kaposi's sarcoma: data from the multicenter AIDS cohort study. *Journal of Infectious Diseases*, **173**, 1477–1480.
- Howard, M.R., Whitby, D., Bahadur, G. *et al.* (1997) Detection of human herpesvirus 8 DNA in semen from HIV-infected individuals but not healthy semen donors. *AIDS*, **11**, F15–F19.
- Jaffe, E.S. (1996) Primary body cavity-based AIDS-related lymphomas: evolution of a new disease entity. *American Journal of Clinical Pathology*, **105**, 141–143.
- Jansen-Dürr, P. (1996) How viral oncogenes make the cell cycle. *Trends in Genetics*, **12**, 270–275.
- Kedes, D.H. and Ganem, D. (1997) Sensitivity of Kaposi's sarcoma-associated herpesvirus replication to antiviral drugs. *Journal of Clinical Investigation*, **99**, 2082–2086.
- Kedes, D.H., Operskalski, E., Busch, M. *et al.* (1996) The seroprevalence of human herpesvirus 8 (HHV 8): distribution of infection in Kaposi's sarcoma risk groups and evidence for sexual transmission. *Nature Medicine*, **2**, 918–924.
- Kledal, T.N., Roasenkilde, M.M., Coulin, F. *et al.* (1997) A broad-spectrum chemokine antagonist encoded by Kaposi's sarcoma-associated herpesvirus. *Science*, **277**, 1656–1659.
- Lagunoff, D. and Ganem, D. (1997) The structure and coding organization of the genomic termini of Kaposi's sarcoma-associated herpesvirus (human herpesvirus 8). *Virology*, **236**, 147–154.
- Lee, H., Veazy, R., Williams, K. *et al.* (1998a) Deregulation of cell growth by the K1 gene of Kaposi's sarcoma-associated herpesvirus. *Nature Medicine*, **4**, 435–440.
- Lee, H., Guo, J., Li, M. *et al.* (1998b) Identification of an immunoreceptor tyrosine-based activation motif of K1 transforming protein of Kaposi's sarcoma-associated herpesvirus. *Molecular and Cellular Biology*, **18**, 5219–5228.
- Lennette, E.T., Blackburn, D.J. and Levy, J.A. (1996) Antibodies to human herpesvirus type 8 in the general population and in Kaposi's sarcoma patients. *Lancet*, **348**, 858–861.
- Lock, M.J., Griffiths, P.D. and Emery, V.E. (1997) Development of a quantitative competitive polymerase chain reaction for human herpesvirus 8. *Journal of Virological Methods*, **64**, 19–26.
- Luppi, M., Barozzi, P., Maiorana, A. *et al.* (1996) Human herpesvirus-8 DNA sequences in human immunodeficiency virus-negative angioimmunoblastic lymphadenopathy and benign lymphadenopathy with giant germinal center hyperplasia and increased vascularity. *Blood*, **87**, 3903–3909.
- Mackenzie, J., Sheldon, J., Morgan, G. *et al.* (1997) HHV-8 and multiple myeloma in the UK. *Lancet*, **350**, 1144–1145.
- Martin, J.N., Ganem, D.E., Osmond, D.H. *et al.* (1998) Sexual transmission and the natural history of human herpesvirus 8 infection. *New England Journal of Medicine*, **338**, 948–954.
- Mayama, S., Cuevas, L., Sheldon, J. *et al.* (1998) Prevalence of Kaposi's sarcoma-associated herpesvirus (Human herpesvirus 8) in a young Uganda population. *International Journal of Cancer*, **77**, 817–820.
- Medvezcky, M.M., Horvath, E., Lund, T. *et al.* (1997) *In vitro* antiviral drug sensitivity of the Kaposi's sarcoma-associated herpesvirus. *AIDS*, **11**, 1327–1332.
- Melbye, M., Cook, P.M., Hjalgrim, H. *et al.* (1998) Transmission of human herpesvirus 8 (HHV 8) among homosexual men follows the pattern of a 'Kaposi's sarcoma agent'. *International Journal of Cancer*, **77**, 543–548.
- Miller, G., Rigsby, M.O., Heston, L. *et al.* (1996) Antibodies to butyrate-inducible antigens of Kaposi's sarcoma-associated herpesvirus in patients with HIV-1 infection. *New England Journal of Medicine*, **334**, 1292–1297.
- Mocroft, A., Youle, M., Gazzard, B. *et al.* For the Royal Free/Chelsea and Westminster Hospitals Collaborative Group (1996) Anti-herpesvirus treatment and risk of Kaposi's sarcoma in HIV infection. *Aids*, **10**, 1101–1105.
- Molden, J.C.Y., Moore, P.S. and Goldsmith, M.A. (1997) A Kaposi's sarcoma-associated herpesvirus-encoded cytokine homolog (vIL-6) activates signaling through the shared gp130 receptor subunit. *Journal of Biological Chemistry*, **272**, 19625–19631.
- Moore, P.S., Boshoff, C., Weiss, R.A. *et al.* (1996) Molecular mimicry of human cytokine and cytokine response pathway genes by KSHV. *Science*, **274**, 1739–1744.
- Neipel, F., Albrecht, J.C. and Fleckenstein, B. (1997) Cell-homologous genes in the Kaposi's sarcoma-associated rhadinovirus human herpesvirus 8: determinants of its pathogenicity? *Journal of Virology*, **71**, 4187–4192.
- Nicholas, J., Ruvolo, V., Zong, J. *et al.* (1997a) A single 13-kilobase divergent locus in the Kaposi sarcoma-associated herpesvirus (human herpesvirus 8) genome contains nine open reading frames that are homologous to or related to cellular proteins. *Journal of Virology*, **71**, 1963–1974.
- Nicholas, J., Ruvolo, V.R., Burns, W.H. *et al.* (1997b) Kaposi's sarcoma-associated human herpesvirus-8 encodes homologues of macrophage inflammatory protein-1 and interleukin-6. *Nature Medicine*, **3**, 287–292.
- Nicholas, J., Zong, J., Alcendor, D.J. *et al.* (1998) Novel organizational features captured cellular genes and strain variability within the genome of KSHV/HHV8. *Journal of the National Cancer Institute*, **23**, 79–88.
- Orenstein, J.M., Alkan, S., Blauvelt, A. *et al.* (1997) Visualization of human herpesvirus type 8 in Kaposi's sarcoma by light and transmission electron microscopy. *AIDS*, **11**, F35–F45.
- Parravicini, C., Olsen, S.J., Capra, M. *et al.* (1997) Risk of Kaposi's sarcoma-associated herpesvirus transmission from donor allografts among Italian posttransplant Kaposi's sarcoma patients. *Blood*, **90**, 2826–2829.
- Poole, L.J., Zong, J.-C., Ciuffo, D.M. *et al.* (1999) Comparison of genetic variability at multiple loci across the genomes of the major subtypes of Kaposi's sarcoma-associated herpesvirus reveals evidence for recombination and for two distinct types of open reading frame K15 alleles at the right-hand end.

- Journal of Virology*, **73**, 6646–6660.
- Raab, M.-S., Albrecht, J.-C., Birkmann, A. *et al.* (1998) The immunogenic glycoprotein gp35–37 of human herpesvirus 8 is encoded by open reading frame K8.1. *Journal of Virology*, **72**, 6725–6731.
- Rabkin, C.S., Schulz, T.F., Whitby, D. *et al.* (1998) Interassay correlation of human herpesvirus 8 (HHV-8) serologic tests. *Journal of Infectious Diseases*, **178**, 304–309.
- Rainbow, L., Platt, G.M., Simpson, G.R. *et al.* (1997) the 222–234 kD nuclear protein (LNA) of Kaposi's sarcoma-associated herpesvirus (human herpesvirus 8) is encoded by orf73 and a component of the latency-associated nuclear antigen. *Journal of Virology*, **71**, 5915–5921.
- Regamey, N., Tamm, M., Wernli, M. *et al.* (1998) Transmission of human herpesvirus 8 infection from renal transplant donors to recipients. *New England Journal of Medicine*, **339**, 1358–1363.
- Renne, R., Zhong, W., Herndier, B. *et al.* (1996) Lytic growth of Kaposi's sarcoma-associated herpesvirus (human herpesvirus 8) in culture. *Nature Medicine*, **2**, 342–346.
- Renwick, N., Halaby, T., Weverling, G.J. *et al.* (1998) Serconversion for Kaposi's sarcoma-associated herpesvirus is highly predictive of KS development in HIV-1 infected individuals. *AIDS*, **12**, 2481–2488.
- Rettig, M.B., Ma, H.J., Vescio, R.A. *et al.* (1997) Kaposi's sarcoma-associated herpesvirus infection of bone marrow dendritic cells from multiple myeloma patients. *Science*, **276**, 1851–1854.
- Rose, T.M., Strand, K.B., Schultz, E.R. *et al.* (1997) Identification of two homologs of the Kaposi's sarcoma-associated herpesvirus (human herpesvirus 8) in retroperitoneal fibromatosis of different macaque species. *Journal of Virology*, **71**, 4138–4144.
- Russo, J.J., Bohenzky, R.A., Chien, M.-C. *et al.* (1996) Nucleotide sequence of Kaposi's sarcoma-associated herpesvirus (HHV 8). *Proceedings of the National Academy of Sciences of the USA*, **93**, 14862–14868.
- Said, W., Chien, K., Takeuchi, S. *et al.* (1996) Kaposi's sarcoma-associated herpesvirus (KSHV or HHV8) in primary effusion lymphoma: ultrastructural demonstration of herpesvirus in lymphoma cells. *Blood*, **87**, 4937–4943.
- Sarid, R., Sato, T., Bohenzky, R.A. *et al.* (1997) Kaposi's sarcoma-associated herpesvirus encodes a functional Bcl-2 homologue. *Nature Medicine*, **3**, 293–298.
- Sarid, R., Flore, O., Bohenzky, R.A. *et al.* (1998) Transcriptional mapping of the Kaposi's sarcoma-associated herpesvirus (KSHV) genome in the body cavity-based lymphoma cell line BC-1. *Journal of Virology*, **72**, 1005–1012.
- Schulz, T.F. (1998) Kaposi's sarcoma-associated herpesvirus (human herpesvirus 8). *Journal of General Virology*, **79**, 1573–1591.
- Schulz, T.F. (1999) Epidemiology of Kaposi's sarcoma-associated herpesvirus/human herpesvirus 8. *Advances in Cancer Research*, **76** (in press).
- Schulz, T.F. and Weiss, R.A. (1995) A finger on the culprit. *Nature*, **373**, 17–18.
- Schulz, T.F., Chang, Y. and Moore, P.S. (1998) Kaposi's sarcoma-associated herpesvirus (human herpesvirus 8). In *Human Tumor Viruses* (ed. D.J. McCance) pp 87–134. ASM Press, Washington DC.
- Simpson, G.R., Schulz, T.F., Whitby, D. *et al.* (1996) Prevalence of Kaposi's sarcoma-associated herpesvirus infection measured by antibodies to recombinant capsid protein and latent immunofluorescence antigen. *Lancet*, **348**, 1133–1138.
- Smith, M.S., Bloomer, C., Horvat, R. *et al.* (1997) Detection of human herpesvirus 8 DNA in Kaposi's sarcoma lesions and peripheral blood of human immunodeficiency virus-positive patients and correlation with serologic measurements. *Journal of Infectious Diseases*, **176**, 84–93.
- Sitas, F., Carrara, H., Beral, V., *et al.* (1999) Antibodies against human herpesvirus 8 in black South African patients with cancer. *New England Journal of Medicine*, **340**, 1863–1871.
- Soulier, J., Grollet, L., Oksenhendler, E. *et al.* (1995) Kaposi's sarcoma-associated herpesvirus-like DNA sequences in multicentric Castlemann's disease. *Blood*, **86**, 1276–1280.
- Staskus, K.A., Zhong, W., Gebhard, K. *et al.* (1997) Kaposi's sarcoma-associated herpesvirus gene expression in endothelial (spindle) tumor cells. *Journal of Virology*, **71**, 715–719.
- Stürzl, M., Blasig, C., Schreier, A. *et al.* (1997) Expression of HHV-8 latency-associated T0.7 RNA in spindle cells and endothelial cells of AIDS-associated, classical and African Kaposi's sarcoma (KS). *International Journal of Cancer*, **72**, 68–71.
- Sun, R., Lin, S.-F., Gradoville, L. *et al.* (1998) A viral gene that activates lytic cycle expression of Kaposi's sarcoma-associated herpesvirus. *Proceedings of the National Academy of Sciences of the USA*, **95**, 10866–10871.
- Swanton, C., Mann, D.J., Fleckenstein, B. *et al.* (1997) Herpes viral cyclin/cdk6 complexes evade inhibition by CDK inhibitor proteins. *Nature*, **390**, 184–187.
- Teodoro, J.G. and Branton, P.E. (1997) Regulation of apoptosis by viral gene products. *Journal of Virology*, **71**, 1739–1746.
- Thome, M., Schneider, P., Hofman, K. *et al.* (1997) Viral FLICE-inhibitory proteins (FLIPs) prevent apoptosis induced by death receptors. *Nature*, **386**, 517–521.
- Vieira, J.D., Hunag, L., Koelle, D.M. *et al.* (1997) Transmissible Kaposi's-associated herpesvirus (human herpesvirus) in saliva of men with a history of Kaposi's sarcoma. *Journal of Virology*, **71**, 7083–7087.
- Whitby, D., Howard, M.R., Tenant-Flowers, M. *et al.* (1995) Detection of Kaposi sarcoma-associated herpesvirus (KSHV) in peripheral blood of HIV-infected individuals predicts progression to Kaposi's sarcoma. *Lancet*, **346**, 799–802.
- Whitby, D., Luppi, M., Barozzi, P. *et al.* (1998) Human herpesvirus 8 seroprevalence in blood donors and patients with lymphoma from different regions of Italy. *Journal of the National Cancer Institute*, **90**, 395–397.
- Zhong, W. and Ganem, D. (1997) Characterization of ribonucleoprotein complexes containing an abundant polyadenylated nuclear RNA encoded by Kaposi's sarcoma-associated herpesvirus (human herpesvirus 8). *Journal of Virology*, **71**, 1207–1212.
- Zhong, W., Wang, H., Herndier, B. *et al.* (1996) Restricted expression of Kaposi's sarcoma-associated herpesvirus (human herpesvirus 8) genes in Kaposi's sarcoma. *Proceedings of the National Academy of Sciences of the USA*, **93**, 6641–6646.
- Zong, J.-C., Metroka, C., Reitz, M.S. *et al.* (1997) Strain variability among Kaposi sarcoma-associated herpesvirus (human herpesvirus 8) genomes: evidence that a large cohort of United States AIDS patients may have been infected by a single common isolate. *Journal of Virology*, **71**, 2505–2511.
- Zong, J.-C., Ciuffo, D.M., Alcendor, D.J. *et al.* (1999) High-level variability in the orfK1 membrane protein gene at the left end of the Kaposi's sarcoma-associated herpesvirus genome defines four major virus subtypes and multiple variants or clades in different human populations. *Journal of Virology*, **73**, 4156–4170.

Hepatitis Viruses

Tim J. Harrison, Geoffrey M. Dusheiko and Arie J. Zuckerman
Royal Free and University College Medical School, London, UK

INTRODUCTION

Hepatitis, characterized by necrosis and inflammation in the liver, may result from infection with a variety of viruses and is the main clinical outcome of infection with viruses from several different families. The predominantly hepatotropic viruses, which vary in prevalence throughout the world, may be considered together, although the biology of these viruses and the spectrum of disease they cause differ considerably.

The clinical spectrum of disease ranges from an asymptomatic or mild anicteric illness, to acute disease with jaundice, to severe prolonged jaundice or fulminant hepatitis. Where the infection persists, chronic hepatitis may ensue and, here, the outcome is also variable. Inapparent or subclinical and anicteric infections are common. *Hepatitis A* and *E viruses* (HAV and HEV) do not persist in the liver and there is no evidence of direct progression to chronic liver damage. However, *Hepatitis B virus* (HBV), with or without its satellite, *Hepatitis D virus* (HDV or delta agent), and the major agent of parenterally-transmitted non-A, non-B hepatitis, *Hepatitis C virus* (HCV), may be associated with persistent infection, a prolonged carrier state, and progression to chronic liver disease, which may be severe. In addition, there is substantial evidence of an aetiological association between infection with chronic hepatitis B and C and hepatocellular carcinoma.

Hepatitis A, B and D can be differentiated by sensitive laboratory tests for specific antigens and antibodies, and the respective viruses have been

characterized. Enzyme linked immunoassay (ELISA) and recombinant immunoblot assays have been developed for the detection of antibodies to HCV but tests for antigens of this virus are not routinely available and viraemia must be confirmed by testing for the viral genome, for example, using the polymerase chain reaction (PCR). Enzyme immunoassays have been developed for the detection of antibodies to HEV and the genome may be detected using the PCR.

Pathology

Acute Hepatitis

The pathological features that are constant in all types of acute viral hepatitis consist of parenchymal cell necrosis and histiocytic periportal inflammation. The reticulin framework of the liver is usually well preserved, except in some cases of massive and submassive necrosis. The liver cells show necrotic changes that vary in form and intensity. The necrotic areas usually are multifocal, but necrosis frequently tends to be zonal, with the most severe changes occurring in the centrilobular areas. Individual hepatocytes often are swollen and may show ballooning, but they can also shrink giving rise to acidophilic bodies.

Dead or dying rounded liver cells are extruded into the perisinusoidal space. There are variations in the size and staining quality of the nuclei. Fatty changes in the liver are usually not marked, but

some steatosis can be observed in chronic HCV infection. A mononuclear cell infiltration, which is particularly marked in the portal zones, is the characteristic mesenchymal reaction. This is also accompanied by some proliferation of bile ductules.

Kupffer cells and endothelial cells proliferate and the Kupffer cells often contain excess lipofuscin pigment. In the icteric phase of typical acute hepatitis, the walls of the hepatic vein tributaries may be thickened and frequently are infiltrated, with proliferation of the lining cells in the terminal hepatic veins. Cholestasis may occur in the early stages of viral hepatitis, and plugs of bile thrombi may be found in the bile canaliculi; this is a more common feature in hepatitis E.

Spotty or focal necrosis with the associated mesenchymal reaction may also be found in anicteric hepatitis, but on the whole the lesions tend to be less severe than in the icteric type of illness. At the other extreme, there is rapid massive necrosis of the liver cells in fulminant hepatitis.

Repair of the liver lobules occurs by regeneration of hepatocytes; frequent mitoses, polyploidy, atypical cells and binucleated cells are found. There is gradual disappearance of the mononuclear cells from the portal tracts, but elongated histiocytes and fibroblasts may remain. The outcome of acute viral hepatitis may be complete resolution or fatal massive necrosis.

Chronic Hepatitis

The pathological features of chronic hepatitis B depend upon the stage of the disease, the host immune response and the degree of virus replication. In chronic hepatitis B with mild activity, only rare piecemeal necrosis is seen. Characteristic hepatocytes with eosinophilic 'ground-glass' cells are relatively common in anti-HBe-positive patients with low levels of virus replication. Lobular hepatitis is more common in patients with active virus replication, and raised serum aminotransferases. CD8⁺ cells predominate in areas of piecemeal necrosis. HBsAg and HBeAg can be detected by immunoperoxidase staining in routinely fixed liver biopsy sections. Patients with high levels of viraemia may have minimal hepatitis.

The pathological features of HCV infection are quite characteristic, albeit not pathognomonic. The presence of HCV RNA in serum tends to correlate with some degree of hepatitis and disappearance of

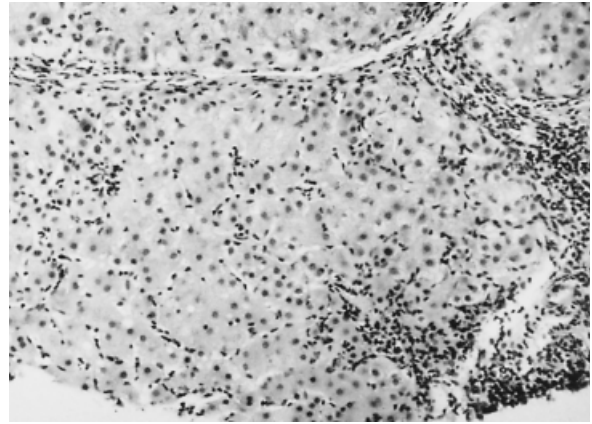

Figure 3.1 Section of a liver biopsy from a patient with chronic hepatitis C seen at low magnification. There is a moderate lymphocytic infiltrate in the portal tracts, with piecemeal necrosis. A scattered mild parenchymal inflammatory infiltrate is also present. (H&E.) (Courtesy of Dr A.P. Dhillon, Department of Histopathology, Royal Free Hospital and School of Medicine)

HCV RNA, for example following successful α -interferon treatment, is followed by histological improvement. Typically, patients with chronic hepatitis C have mild portal tract inflammation with lymphoid aggregates or follicles and mild periportal piecemeal necrosis. Parenchymal steatosis, apoptosis and mild lobular inflammation are present, and portal fibrosis or portal-central fibrosis may be present in later stages of disease. Bridging necrosis is not common. Rarely, granulomas can be observed. Although many of the lymphoid follicles are associated with bile ducts, ductopenia is not observed. Advanced disease, with cirrhosis or hepatocellular carcinoma is not generally associated with distinguishing features.

HCV antigens have been detected in scattered groups of cells, with granular cytoplasmic staining. The periportal lymphocytes around lymphoid follicles are mixed, but contain relatively large numbers of CD4 lymphocytes. Figure 3.1 shows histopathological changes typical of chronic hepatitis C. A characteristic histologic pattern of mild chronic hepatitis with portal lymphoid follicles and varying degrees of lobular activity is found in many patients with persistent hepatitis C infection.

Biochemical Tests of Liver Function

The serum levels of aspartic and alanine aminotransferase are elevated in acute hepatitis, as are levels of

other enzymes released by the damaged liver cells. Usually, the levels of alanine aminotransferase are higher than those of aspartic aminotransferase, a difference particularly marked in hepatitis C. Elevation of these enzymes may be the only abnormality to be found in individuals with asymptomatic and anicteric infections who are tested because of known exposure. Bilirubin is found in the urine and conjugated and total serum bilirubin levels are raised in most symptomatic infections. The leucocyte count usually is normal but some atypical lymphocytes are found frequently.

A progressive decline in serum albumin concentrations and prolongation of the prothrombin time are characteristically observed after decompensated cirrhosis has developed. The serum aspartate aminotransferase may be higher than the serum alanine aminotransferase concentrations in patients with hepatic cirrhosis. A subset of patients with chronic hepatitis C infection may test positive for autoantibodies, including LKM1 antibody.

Clinical Manifestations

Differences between the clinical syndromes of acute hepatitis A, acute hepatitis B and other forms of viral hepatitis become apparent on analysis of large numbers of well-documented cases, but these differences are not sufficiently reliable for the diagnosis of individual patients with icteric disease. Epidemiologic risk factors, for example travel, injections or sexual risk, can indicate a possible aetiology. Fever and headache are more frequent during the prodrome of acute hepatitis A. The late incubation period—early clinical phase is frequently heralded by a variety of non-specific symptoms such as fatigue, anorexia, malaise and myalgias. A few days later, anorexia, nausea, vomiting and right upper quadrant abdominal pain can appear, followed by passage of dark urine and clay-coloured stools and the development of jaundice of the sclera and skin. With the appearance of jaundice, there is usually a rapid subjective improvement in symptoms. The jaundice usually deepens during the first few days and persists for 1 or 2 weeks. The faeces then darken and the jaundice diminishes, at first rapidly and then more slowly, over an additional period of 2 weeks or so. The liver may be palpable in acute severe hepatitis, but only a minority of patients

have palpable splenomegaly. Convalescence may be prolonged, although complete recovery in adults usually takes place within a few months. In children, the prodromal features may be mild or even absent, although anorexia, when present, tends to be severe. The icteric or posticteric phase in children is short. There is no definite evidence of progression of hepatitis A to chronic liver disease, but it has been suggested that autoimmune hepatitis may be triggered in genetically predisposed individuals. These observations have not been confirmed. The prodromal phase of hepatitis B and C is often prolonged and more insidious. Low grade fever, arthralgias and skin rashes, particularly in hepatitis B, are not uncommon. The clinical features of the icteric phase are similar in all types of acute viral hepatitis. The mortality rate of acute hepatitis is low, approximately 0.1–3 deaths per 1000 cases.

Fulminant hepatitis can occur following acute hepatitis A–E; it is more common in hepatitis B. Hepatocellular failure develops rapidly; the patient may be deeply jaundiced or encephalopathy may occur before conspicuous jaundice is evident. Widespread haemorrhage occurs. The prothrombin time is prolonged; an altered prothrombin time is a more reliable indicator of prognosis, and of the need for liver transplantation, than the serum bilirubin or serum aminotransferases.

Fulminant hepatitis is unusual following hepatitis C infection, but has been reported, particularly following chemotherapy. High mortality rates for hepatitis occurring during pregnancy have been reported from India, the Middle East and North Africa. The infection was often considered to be caused by HAV, but is now known to be associated particularly with HEV infection.

HEPATITIS A

Hepatitis A is endemic in all parts of the world, but the exact incidence is difficult to estimate because of the high proportion of asymptomatic and anicteric infections, differences in surveillance and differing patterns of disease. The degree of under-reporting is known to be very high. Serological surveys have shown that infection with HAV is almost universal and, in developing countries, 80–90% of children have serological markers of past infection by the age of 5. In industrialized countries (particularly in

northern Europe, North America and Australia) improvements in sanitation have resulted in a decrease in the incidence of hepatitis A. The prevalence of antibodies in young adults in such countries is 5–20%. As a result, large epidemics have occurred, such as in Greece and Shanghai.

Incubation Period

The incubation period of hepatitis A is between 3 and 5 weeks, with a mean of 28 days. Subclinical and anicteric infections are common, particularly in children, and, although the disease has, in general, a low mortality, adult patients may be incapacitated for many weeks. There is no evidence of persistence of the infection in the liver, and progression to chronic liver damage does not occur. The virus replicates *in vivo* in the liver but it seems likely that the initial site of virus replication may be in the gut. This is not proven and the mechanism by which the virus reaches the liver is unknown, although a transient viraemia has been postulated.

Mode of Spread

Hepatitis A virus is spread by the faecal–oral route, most commonly by person-to-person contact, and infection is particularly common in conditions of poor sanitation and overcrowding. Common source outbreaks result most frequently from faecal contamination of drinking water and food, but waterborne transmission is not a major factor in the industrialized communities. On the other hand, many food-borne outbreaks have been reported in developed countries. This can be attributed to the shedding of large amounts of virus in the faeces (Figure 3.2) during the incubation period of the illness in infected foodhandlers, and the source of the outbreak can often be traced to uncooked food or food which has been handled after cooking. The consumption of raw or inadequately cooked shellfish cultivated in polluted water is associated with a high risk of hepatitis A infection. For example, an epidemic with approximately 300 000 cases in Shanghai in 1988 was attributed to the ingestion of raw clams (Halliday *et al.*, 1991). However, although hepatitis A is common in the developed countries, the infection occurs mainly in small clus-

ters and often with only few identified cases. Hepatitis A is highly endemic in many tropical and subtropical areas, with the occasional occurrence of large epidemics. The infection frequently is acquired by travellers from areas where the infection is of low prevalence to areas where hepatitis A is hyperendemic.

Age Incidence

All age groups are susceptible to hepatitis A and disease severity increases with age. As noted above, most individuals in highly endemic areas are infected before 5 years of age but in many countries in northern Europe and in North America most clinical cases occur in adults. In countries where there has been improvement in socioeconomic conditions and sanitation, such as southern Europe and China, there has been an increase in the mean age of infection. In many developed countries, the prevalence of antibodies to hepatitis A has fallen to 5–10% of young adults and there is thus a large susceptible population. The diminishing incidence of hepatitis A is now matched by an increasing incidence of clinically apparent disease.

This shift in age incidence is similar to that which occurred with poliomyelitis during and after World War II, reflecting improvement in socioeconomic and hygienic conditions and a consequent shift in herd immunity.

Seasonal Pattern

In temperate zones, the characteristic seasonal trend is for an increase in incidence in the autumn and early winter months, falling progressively to a minimum during the midsummer. However, more recently the seasonal peak has been lost in some countries. In many tropical countries the peak of the infection tends to occur during the rainy season, with a lower incidence during the dry periods.

Biology of HAV

The hepatitis A virion is a non-enveloped particle measuring 25–28 nm in diameter (Figure 3.3) and containing a linear genome of single-stranded

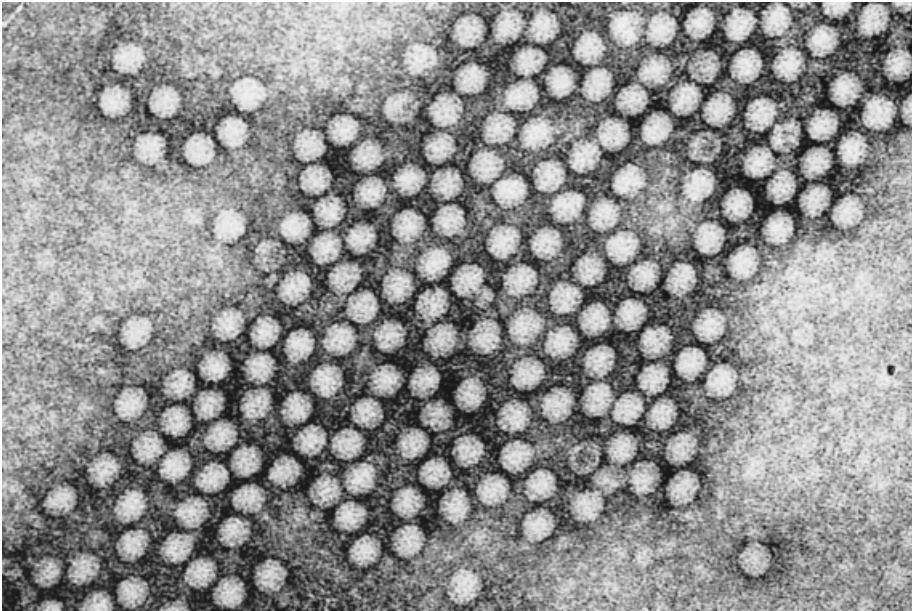

Figure 3.2 Electron micrograph showing hepatitis A virus in faecal extracts obtained during the early acute phase of illness. The particles measure about 27 nm in diameter. ($\times 170\,000$) (From a series by Anthea Thornton and A.J.Zuckerman)

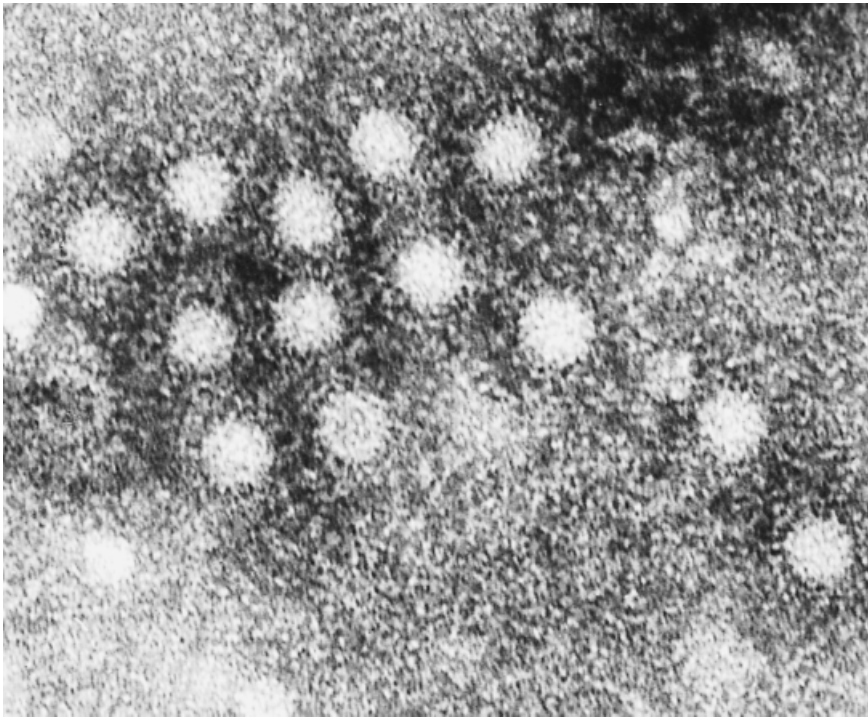

Figure 3.3 Electron micrograph showing a large aggregate of hepatitis A virus particles heavily coated with antibody, giving the appearance of a 'halo'. 'Full' and 'empty' particles are shown. ($\times 340\,000$) (From a series by Anthea Thornton and A.J. Zuckerman)

RNA, approximately 7500 nucleotides in length and coding for three major structural polypeptides with molecular weights of 33 000, 29 000 and 27 000 (VP1, VP2 and VP3). A fourth, truncated VP4 polypeptide of only 17 amino acids has been predicted from the nucleotide sequence of the virus but has not been detected experimentally. X-ray crystallographic studies have not yet been reported but the basic structure of the capsid may be predicted from such studies of other picornaviruses; the antigenic structure has been defined further by analysis of neutralization escape mutants selected by monoclonal antibodies. These studies suggest that the immunodominant neutralization site is a conformational epitope comprising residues of VP1 and VP3 (Ping and Lemon, 1992). It is believed that secondary or higher orders of protein structure may play essential roles in this antigenic site, since it has not been possible to detect this predominant antigen in virus preparations disrupted with detergent or following expression of recombinant protein (although expression of the entire HAV polyprotein may enable assembly of antigenic virus-like particles in cell culture, as noted below).

HAV is exceptionally stable; it is ether resistant, stable at pH 3.0 and relatively resistant to inactivation by heat. HAV retains its physical integrity and biological activity at 60°C for 10 hours but is inactivated after 5 minutes at 100°C. The virus also may be inactivated by ultraviolet irradiation and by treatment with a 1:4000 concentration of formaldehyde solution at 37°C for 72 hours. There is also evidence that HAV is inactivated by chlorine at a concentration of 1 mg/l⁻¹ for 30 minutes.

Genetic Organization

The organization of the genome of HAV is similar to other picornaviruses and it was originally classified as enterovirus type 72 (Gust *et al.*, 1983). However, there are substantial differences between HAV and the established four genera of the picornavirus family, for example an unusually low GC content of 38% and very limited sequence homology. Consequently, HAV has been reclassified in its own genus, *Hepatovirus*, of the family *Picornaviridae*.

Cloning and sequencing data (Cohen *et al.*, 1987) indicate that the genome of HAV consists of 7478 nucleotides with a 5' non-coding region of 733 nucleotides and a shorter non-coding region and poly(A) tract at the 3' terminus. A small protein (VPg) is bound covalently at the 5' terminus. A single open reading frame (ORF) extends from nucleotide 710–750 to about 60 nucleotides in advance of the 3' terminal poly(A) tract. This sequence can encode a polyprotein with molecular weight of about 250 000. The predicted amino acid sequence compared with analogous regions of other picornaviruses suggests that the 5' region of the ORF codes for the three major structural proteins of the virus along with the fourth, small VP4. The 3' region encodes a protease which processes the polyprotein and the polymerase and other functions involved in genome replication. Dipeptide cleavage sites which have been identified in a number of picornavirus polyproteins are not conserved in HAV but attempts have been made to predict the cleavage pattern and post-translational processing of the polyprotein (Figure 3.4). The cellular receptor for HAV has been identified recently (Kaplan *et al.*, 1996).

leotides and a shorter non-coding region and poly(A) tract at the 3' terminus. A small protein (VPg) is bound covalently at the 5' terminus. A single open reading frame (ORF) extends from nucleotide 710–750 to about 60 nucleotides in advance of the 3' terminal poly(A) tract. This sequence can encode a polyprotein with molecular weight of about 250 000. The predicted amino acid sequence compared with analogous regions of other picornaviruses suggests that the 5' region of the ORF codes for the three major structural proteins of the virus along with the fourth, small VP4. The 3' region encodes a protease which processes the polyprotein and the polymerase and other functions involved in genome replication. Dipeptide cleavage sites which have been identified in a number of picornavirus polyproteins are not conserved in HAV but attempts have been made to predict the cleavage pattern and post-translational processing of the polyprotein (Figure 3.4). The cellular receptor for HAV has been identified recently (Kaplan *et al.*, 1996).

Cell Culture

The successful propagation of HAV in 1979 in primary monolayer and explant cell cultures and in continuous cell lines of primate origin was a major advance and opened the way to the preparation of hepatitis A vaccines. The viral capsid antigens are detectable by immunofluorescence and radioimmunoassay, and the viral RNA by an indirect, quantitative autoradiographic plaque assay and by complementary DNA–RNA hybridization and reverse transcriptase (RT)-PCR. HAV does not induce cytopathic changes in culture but tends to establish persistent infections and remain largely cell associated. However, primary isolation of wild-type virus is difficult and several weeks elapse before antigen is detectable in the cytoplasm of infected cells. Thus, virus isolation is not a practical diagnostic technique in routine laboratories.

Adaptation to growth in cultured cells occurs with repeated passage, with more rapid production of intracellular antigen and with higher final yields. Virus adapted to growth in cell culture may become attenuated and the nucleotide sequences of wild-type and attenuated strains have been compared. There is evidence that changes in the 5' non-coding

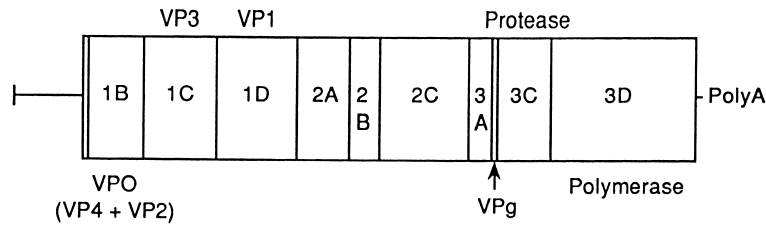

Figure 3.4 Organization of the hepatitis A virus genome. See text for details

region and the region encoding non-structural (2B/2C) polypeptides may be associated with attenuation and adaptation to cell culture.

Only one serotype of hepatitis A has been identified in human volunteers infected experimentally, in patients from different outbreaks of hepatitis A and in naturally and experimentally infected chimpanzees and monkeys. This has also been confirmed by cross-neutralization tests and by the protective efficacy of pooled human immunoglobulin obtained from different geographical regions. However, strain specific differences exist at least at the level of the nucleotide sequences of viral RNA from different isolates of HAV. A pairwise comparison of the nucleotide sequence of 168 bases from 152 strains of HAV revealed that these can be classified into seven unique genotypes, three of which were isolated from Old World monkeys. The RNA genome of the virus, like those of other picornaviruses, is subject to relatively high rates of spontaneous mutation.

Pathogenesis

The mechanisms underlying liver injury in hepatitis A are not understood. The initial non-cytopathic phase, during which virus replicates and is released, is followed by decreased virus multiplication and inflammatory cell infiltration, suggesting that immune mechanisms are involved in pathogenesis. Experimental evidence suggests that HLA-restricted, virus specific T cells play a significant role in HAV-related hepatocellular injury. T cell clones have been derived from patients with acute hepatitis A and analysed for their phenotype. CD8⁺ clones isolated during the acute phase of the disease predominate over CD4⁺ clones; these CD8⁺ clones have cytotoxic activity and show specific cytotoxicity against autologous fibroblasts infected with

HAV. These data support the hypothesis that liver cell injury in acute HAV infection is mediated by HAV-specific CD8⁺ T lymphocytes, and is not entirely due to an intrinsic cytopathic effect of the virus itself. The molecular targets of these cells are unknown. Serum neutralizing antibodies protect against HAV infection.

Laboratory Diagnosis

Specific diagnosis of hepatitis A can be established by demonstrating the virus in faeces by enzyme immunoassay and radioimmunoassay or by immune electron microscopy and RT-PCR. Isolation of the virus in cell cultures is not yet feasible nor appropriate for routine diagnosis.

As stated above, the capsid antigen is highly conserved and there is only a single serotype of HAV. Specific serological tests for hepatitis A antigen (HAAg) and antibodies include radioimmunoassay and enzyme-linked immunosorbent assay. Hepatitis A antibody (anti-HAV) is always demonstrable by such assays during the early phase of the illness and titres increase rapidly (Figure 3.5). Since antibody develops very early in the course of the infection, serological diagnosis of recent infection can be established by titrations of serial samples of serum or, more conveniently, by the demonstration of hepatitis A antibody of the IgM class. This is the simplest and most economical method of establishing the diagnosis. Hepatitis A IgM is detectable in serum for 45–60 days after the onset of symptoms. Liver biopsy is not usually required in acute hepatitis A. Titres of anti-HAV in IgG rise with convalescence and the antibody usually persists for many years. Recovery from infection is associated with lifelong immunity.

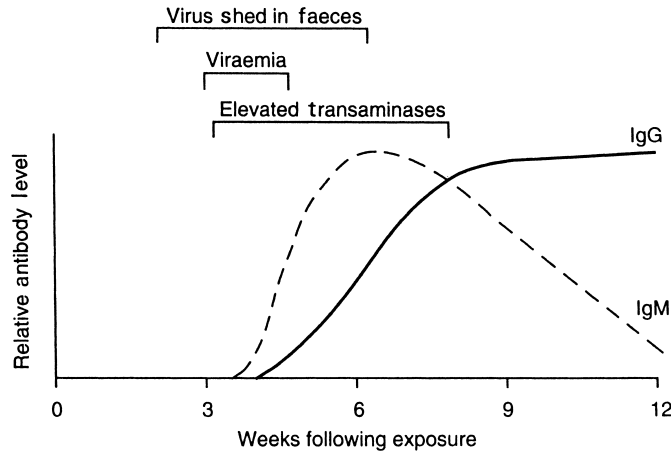

Figure 3.5 Serological profile during uncomplicated hepatitis A

Clinical Course

Clinical disease with jaundice is uncommon in infants and young children and the infection may pass unnoticed in this group. Severe hepatitis is correspondingly more common in older persons. Recurrent hepatitis has been observed in patients (and experimentally-inoculated Saimiri monkeys with acute disease) and may be associated with shedding of virus in stools. The relapses are generally benign, with eventual complete resolution. The absence of chronic infection indicates the effectiveness of the host immune response to HAV. In genetically susceptible individuals it is possible that hepatitis A may trigger an autoimmune chronic hepatitis. Vento *et al.* (1991) identified individuals who possessed a defect in suppressor-inducer T lymphocytes controlling immune responses to the asialoglycoprotein receptor. These subjects developed a persistent response to the asialoglycoprotein receptor, and autoimmune hepatitis after subclinical hepatitis A. Approximately 5% of patients with acute hepatitis A will develop cholestatic hepatitis, characterized by pruritus and steatorrhea.

Prevention and Control of Hepatitis A

Control of infection is difficult. Strict isolation of cases is not a useful control measure because faecal shedding of the virus is at its highest during the late incubation period and prodromal phase of the ill-

ness. Spread of hepatitis A is reduced by simple hygienic measures and the sanitary disposal of excreta.

Normal human immunoglobulin (NHIG), containing at least 100 iu ml^{-1} anti-HAV, will prevent or attenuate a clinical illness if given intramuscularly before exposure to the virus or early during the incubation period. The dosage should be at least $2 \text{ iu anti-HAV kg}^{-1}$ body weight (Table 3.1), but in special cases, such as pregnancy or in patients with liver disease, the dosage may be doubled. Immunoglobulin does not always prevent infection and excretion of HAV, and inapparent or subclinical hepatitis may develop. The efficacy of passive immunization is based on the presence of hepatitis A antibody in the immunoglobulin, but the minimum titre of antibody required for protection has not yet been established. Immunoglobulin is used most commonly for close personal contacts of patients with hepatitis A and for those exposed to contaminated food. Immunoglobulin has also been used effectively for controlling outbreaks in institutions such as homes for the mentally handicapped and in nursery schools.

Prior to the availability of a vaccine, pre-exposure prophylaxis with immunoglobulin was recommended for persons without hepatitis A antibody visiting highly endemic areas. After a period of 6 months the administration of immunoglobulin for travellers had to be repeated, unless it could be demonstrated that the recipient had developed his own hepatitis A antibodies. Because the shift in herd immunity has led to reduced titres of anti-

Table 3.1 Passive immunization with normal immunoglobulin for travellers to highly endemic areas

Person's body weight (kg)	Period of stay < 3 months	Period of stay > 3 months
< 25	50iu anti-HAV (0.5 ml)	100iu anti-HAV (1.0 ml)
25–30	100iu anti-HAV (1.0 ml)	250iu anti-HAV (2.5 ml)
> 50	200iu anti-HAV (2.0 ml)	500iu anti-HAV (5.0 ml)

HAV in normal immunoglobulin in developed countries and a highly immunogenic vaccine has become available, a single dose of vaccine may be offered to travellers, with the option of a booster dose 6–12 months later.

Hepatitis A Vaccines

There has been considerable interest in the development of both killed and attenuated hepatitis A vaccines and inactivated vaccines are now licensed in many countries. The virus grows poorly in cell culture but yields have been improved by adaptation and are sufficient to permit gradient purification. This virus is inactivated with formaldehyde and the antigen adsorbed to aluminium hydroxide and given intramuscularly. These preparations are safe and immunogenic in humans and have been shown to induce a protective immune response. Safety and immunogenicity studies and efficacy trials have been undertaken in volunteers with formaldehyde-inactivated, aluminium hydroxide adsorbed vaccines (Havrix, SmithKline Beecham (SKB), or Vaqta, Merck Research Laboratories) (Flehmig *et al.*, 1989; Ellerbeck *et al.*, 1992; Werzberger *et al.*, 1992). Both anti-HAV (Abbott RIA) and neutralizing antibodies develop. The currently licensed vaccines appear to be well tolerated and immunogenic at doses of 720–1440 arbitrary 'ELISA' units (SKB) or 125–250 units (Merck). In the case of the SKB vaccine licensed in the UK, a single dose of 720 ELISA units of hepatitis A viral protein is sufficient for protection of adults of 16 years and over, with the option of a booster dose 6–12 months later. A juvenile formulation with 320 ELISA units per dose is available. Active immunization induces higher levels of both total and neutralizing antibodies than NHIG.

Inactivated vaccines of this type are useful for the

protection of travellers from prosperous countries but are likely to be too costly for use in the developing world, where exposure usually occurs early in life. In developed countries, the vaccine should be given to travellers to countries where HAV is endemic, armed forces personnel, diplomats, staff of children's daycare centres and of institutions for intellectually handicapped individuals, male homosexuals, intravenous drug abusers, haemophiliacs and sewage workers. If immediate protection is required, travellers will require passive immunization with immunoglobulin as well as vaccine to confer protection, or possibly a single dose of 1440 ELISA units. The cost:benefit ratio of HAV vaccination is probably most beneficial when vaccine is given to frequent travellers to endemic areas. Where practical, testing for antibodies to hepatitis A prior to immunization may be indicated in those aged 50 years or over, those born in areas of high endemicity and those with a history of jaundice.

HAV vaccine is also recommended for individuals with significant chronic liver disease due to hepatitis B or C infection. Individuals exposed to hepatitis A may be offered a primary dose of vaccine with normal human immunoglobulin at a different injection site.

Attenuated strains of HAV have been developed and potentially may be useful as vaccines. This approach is attractive because live vaccines may be cheaper to produce (the attenuated virus grows more efficiently in cell culture), can be given orally and may induce a mucosal antibody response. As with vaccine strains of polioviruses, attenuation may be associated with mutations in the 5' non-coding region of the genome which affect secondary structure. There is also evidence that mutations in the region of the genome encoding the non-structural polypeptides (region 2B/2C, Figure 3.4; Emerson *et al.*, 1992) may be important for adaptation to cell culture and attenuation. However, the markers of attenuation of HAV are not so well defined as

those for the polioviruses, and reversion to virulence may be a problem also. There is also concern that 'overattenuated' viruses may not be sufficiently immunogenic.

Although there is some sequence variation between different isolates of HAV and evidence for different strains infecting non-human primates, there is only one serotype of the virus and immunity gives effective cross-protection against all strains. Considerable efforts have been made to define the epitope(s) involved. The immunodominant epitope may be highly conformational and involve alignment of domains from VP1 and VP3, posing problems for expression of immunogenic proteins using recombinant DNA technology. A recombinant vaccinia virus expressing most of the HAV capsid coding region has been shown to protect tamarin monkeys from subsequent challenge (Karayiannis *et al.*, 1991). Expression of the entire HAV polyprotein using a recombinant vaccinia virus led to assembly of virus-like particles in cells infected in culture.

HEPATITIS E

Epidemic hepatitis, which resembles but is serologically distinct from hepatitis A, has been reported from the Indian subcontinent (Khuroo, 1980), central and southeast Asia, the Middle East, North Africa and Central America. The disease also is a common cause of acute sporadic hepatitis in these countries. Sporadic cases have been observed in developed countries among migrant labourers and travellers returning from such areas. In contrast to prior epidemics of enterically transmitted non-A, non-B hepatitis, HEV was found to be a common cause of acute hepatitis in a paediatric population in Egypt. Seroprevalence studies in Hong Kong suggest that hepatitis E accounts for a third of non-A, non-B, non-C hepatitis, and that coinfection of hepatitis A and E can occur (Lok *et al.*, 1992).

The average incubation period is slightly longer than for hepatitis A, with a mean of 6 weeks. The infection is acute and self-limiting. Clinical disease occurs predominantly in young adults, and high mortality rates (up to 20%) have been reported in the third trimester of pregnancy. The infection is spread by the ingestion of contaminated water and probably by food, but secondary clinical cases seem to be uncommon.

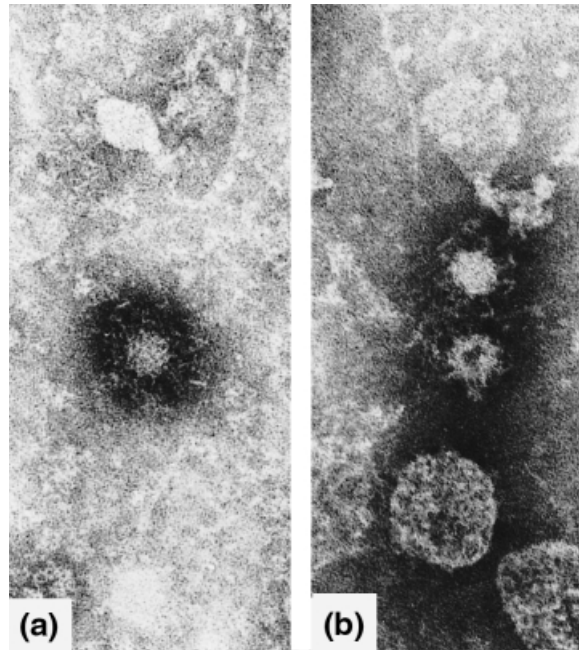

Figure 3.6 Immune electron microscopy of HEV from a faecal extract. (a) Particle coated with predominately IgG. (b) Particles coated with predominately IgM. (From Purcell and Ticehurst (1988) with permission)

Virus-like particles have been detected in the stools of infected individuals by immune electron microscopy using convalescent serum (Figure 3.6). However, such studies often have proved inconclusive and a large proportion of the excreted virus may be degraded during passage through the gut. The particles are slightly larger than those of hepatitis A, with a mean diameter of 32–34 nm. Cross-reaction studies between sera and virus in stools associated with a variety of epidemics in several different countries suggest a single viral serotype (Bradley, 1992).

Biology of HEV

Research into the viral agent of enterically transmitted, non-A, non-B hepatitis (ET-NANBH), now known as *Hepatitis E virus*, advanced following the development of animal models (Bradley *et al.*, 1988). HEV was first transmitted to cynomolgous macaques and subsequently a number of other species of monkeys and chimpanzees have been infected. The problem of degradation of HEV in the gut was circumvented when the gallbladder bile of in-

fected monkeys was found to be a rich source of virus. This material enabled the molecular cloning of DNA complementary to the HEV (RNA) genome and the entire 7.2 kb sequence was determined (Tam *et al.*, 1991). The organization of the genome is distinct from the picornaviruses; the non-structural polypeptides are encoded in the 5' region and the structural polypeptides at the 3' end. HEV resembles the caliciviruses in the size and organization of its genome as well as the size and morphology of the virion.

Recently, a virus which is closely related to HEV has been discovered in several herds of swine in the USA (Meng *et al.*, 1997). Whether this virus also infects humans remains to be determined but the detection of anti-HEV in around 2% of random blood donors in the USA (Dawson *et al.*, 1992) may be significant.

Organization of the HEV Genome

The HEV genome is a polyadenylated, positive-sense RNA of around 7200 nt which contains three ORFs (Figure 3.7). The first, of approximately 5 kb, begins 28 nt from the 5' end of the genome and encodes motifs associated with NTP-binding, helicase and RNA-dependent RNA polymerase activities. A second ORF of around 2 kb begins 37 nt downstream of the first, terminates 68 nt from the poly(A) tail and is believed to encode the structural polypeptides. The third ORF is very short (369 nt) and overlaps the other two. Subgenomic RNAs may be synthesized for translation of the second and third ORFs and the products of all three may be subject to proteolytic processing and other post-translational modifications.

Sequencing of the HEV genome has enabled the development of a number of specific diagnostic tests. For example, HEV RNA was detected, using the PCR, in stool samples obtained during an epidemic in Kanpur (north India) and may also be detected in infected liver. ELISA assays, which detect IgG and IgM anti-HEV, have been developed (Dawson *et al.*, 1992) and used to detect antibodies in sporadic cases of ET-NANBH in children in Egypt and elsewhere. One assay employs four recombinant HEV antigens expressed in *Escherichia coli* as fusion proteins with glutathione-S-transferase, and another is based on synthetic peptides.

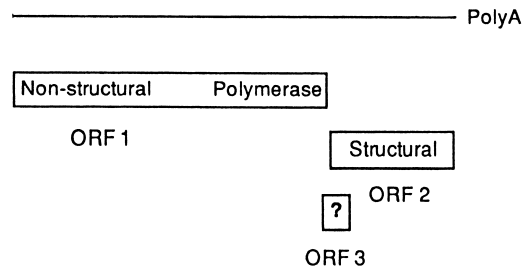

Figure 3.7 Organization of the hepatitis E virus genome. See text for details

Pathogenesis

After HEV inoculation macaque monkeys develop acute viral hepatitis associated with a rise in liver enzymes, the presence of HEV specific viral particles in the stool and histological changes in the liver from 21 to 45 days after infection. Ultrastructural changes in the livers of these experimental monkeys include infiltration of lymphocytes and polymorphonuclear leucocytes around the necrotic area, swelling of mitochondria, dilatation of smooth endoplasmic reticulum and presence of 27–34 nm virus particles during the acute phase of the disease. It is not known whether these changes reflect cytopathic liver injury or immune-mediated damage.

Diagnosis

With the availability of recombinant antigens and synthetic peptides, serological assays were developed to test for antibody to HEV (anti-HEV). These are based on antigens that were initially identified by blind immunoscreening using convalescent sera from infected individuals. Western blot assays are able to detect IgM anti-HEV. Specific IgM is detected infrequently at initial presentation and has disappeared within 3 months of the onset of jaundice. Specific IgG titres can be quite high, but tend to disappear over time. The diagnosis can be confirmed by detecting the virus genome in faecal material from acutely infected patients using RT-PCR. Bile from experimentally infected monkeys is also positive by this technique (Jameel *et al.*, 1992). Attack rates have been higher in males than females and for adults rather than children. Evidence of

secondary intrafamilial spread is uncommon (Naik *et al.*, 1992).

Clinical Features

An early observation was the high mortality (10–20%) in pregnant women due to fulminant hepatitis. Fulminant hepatitis E has been reported in the UK, but appears to be a relatively infrequent cause elsewhere. In general, the disease is self-limited with no evidence of chronic infection. Liver biopsies obtained during the acute illness show portal inflammation and cytoplasmic cholestasis. Stool specimens may reveal 27–32 nm virus-like particles when tested by immune electron microscopy (IEM) but RT-PCR is a more reliable assay for the virus.

Immunization

Although individuals who recover from hepatitis E mount an antibody response, including to putative capsid antigens, it is not clear whether these antibodies protect against subsequent infection or, if so, how long that immunity lasts. Adult populations in endemic areas are susceptible to hepatitis E, with high attack rates in epidemics. Preliminary findings indicate that hyperimmune rabbit antisera against HEV antigens contain neutralizing activity. However, the degree and longevity of protective immunity of macaque monkeys following recovery from experimental infection or immunization with recombinant DNA or antigen preparations is controversial. Prospects for the development of hepatitis E vaccines were reviewed recently (Panda and Nanda, 1997). Purdy *et al.* (1993) demonstrated that immunization with a bacterially-expressed fusion protein, derived from the capsid region of the Burmese strain, protected cynomolgus macaques from challenge with the homologous strain of virus. However, monkeys challenged with the Mexican strain excreted virus in their faeces, although there was no biochemical evidence (i.e. raised transaminases) of liver disease. In another study, an immunogen derived from the capsid region of the Pakistan strain was found to protect against infection with the Mexican strain (Tsarev *et al.*, 1994). Aside from the duration of a protective antibody response, other caveats are that animals frequently are challenged

intravenously with HEV, rather than via the natural (oral) route, and that macaques do not suffer overt symptoms of hepatitis during infection—protection often is defined as the absence of elevated transaminases despite evidence of virus replication (excretion in the faeces).

HEPATITIS B

Epidemiology

The discovery in 1965 of Australia antigen (now referred to as hepatitis B surface antigen, HBsAg) and the demonstration by Blumberg and his colleagues and others of its association with type B hepatitis (Blumberg *et al.*, 1965) led to rapid and unabated progress in the understanding of this complex infection. Hepatitis B remains a globally important disease. Low (less than 2% of the population seropositive for HBsAg), intermediate (2–8%) and high prevalence (more than 8%) areas are recognized. Several epidemiological studies indicate that the reported rates of hepatitis B infection have declined in western and northern Europe, and the USA. Infection rates in children have declined in high prevalence areas where the universal immunization of infants has been introduced.

In the past, hepatitis B was diagnosed on the basis of infection occurring approximately 60–180 days after the injection of human blood or plasma fractions or the use of inadequately sterilized syringes and needles. The development of specific laboratory tests for hepatitis B confirmed the importance of the parenteral routes of transmission, and infectivity appears to be especially related to blood. However, several factors have altered the epidemiological concept that hepatitis B is spread exclusively by blood and blood products. These include the observations that under certain circumstances the virus is infective by mouth, that it is endemic in closed institutions and institutions for the mentally handicapped, that it is more prevalent in adults in urban communities and in poor socioeconomic conditions, that there is a huge reservoir of carriers of markers of HBV in the human population, and that the carrier rate and age distribution of the surface antigen vary in different regions.

There is much evidence for the transmission of

hepatitis B by intimate contact and by the sexual route. The sexually promiscuous, particularly male homosexuals, are at very high risk. HBsAg has been found in blood and in various body fluids, such as saliva, menstrual and vaginal discharges, seminal fluid, colostrum and breast milk, and serous exudates, and these have been implicated as vehicles of transmission of infection. The presence of the antigen in urine, bile, faeces, sweat and tears has been reported occasionally, but has not been confirmed. It is not surprising, therefore, that contact-associated hepatitis B is of major importance. Transmission of the infection may result from accidental inoculation of minute amounts of blood or fluid contaminated with blood during medical, surgical and dental procedures; immunization with inadequately sterilized syringes and needles; intravenous and percutaneous drug abuse; tattooing; ear and nose piercing; acupuncture; laboratory accidents; and accidental inoculation with razors and similar objects that have been contaminated with blood. Additional factors may be important for the transmission of hepatitis B infection in the tropics; these include traditional tattooing and scarification, blood letting and ritual circumcision. Investigation of the role that biting insects may play in the spread of hepatitis B has yielded conflicting results. HBsAg has been detected in several species of mosquitoes and in bed-bugs that were either trapped in the wild or fed experimentally on infected blood, but no convincing evidence of replication of the virus in insects has been obtained. Mechanical transmission of the infection, however, is a possibility (Byrom *et al.*, 1973).

Perinatal Transmission

Viraemic mothers, especially those who are seropositive for HBeAg, almost invariably transmit the infection to their infants at the time of, or shortly after, birth. Such perinatal infections lead to a high rate of chronicity, estimated at around 90%. It has been suggested that the soluble HBeAg may cross the placenta and tolerize the fetus *in utero*. Individuals infected at such an early age exhibit a high degree of immune tolerance and may remain viraemic for decades. Perinatal transmission is an extremely important factor in maintaining the reservoir of the infection in some regions, particularly in

China and southeast Asia. There is also a substantial risk of perinatal infection if the mother had acute hepatitis B in the second or third trimester of pregnancy or within 2 months of delivery. Although hepatitis B virus can infect the fetus *in utero*, this appears to be rare and is generally associated with antepartum haemorrhage and tears in the placenta. The mechanism of perinatal infection is uncertain, but it occurs probably during or shortly after birth as a result of a leak of maternal blood into the baby's circulation, or of its ingestion or inadvertent inoculation.

However, mother-to-infant transmission does not account for at least 50% of infections in children, and horizontal transmission, i.e. child-to-child transmission is equally important. The prevalence in children is quite low at 1 year of age but increases rapidly thereafter, and in many endemic regions the prevalence reaches a peak in children 7–14 years of age. Clustering of HBV also occurs within family groups, but does not appear to be related to genetic factors and does not reflect maternal or venereal transmission. The probability of a childhood infection becoming persistent declines with age, from around 90% in neonates to less than 5% in adolescence.

Chronic Hepatitis B

Chronic hepatitis B is defined as persistence of HBsAg in the circulation for more than 6 months. The 'carrier state' (the term may be inappropriate) may be lifelong and may be associated with liver damage varying from mild chronic hepatitis to severe, active hepatitis, cirrhosis and primary liver cancer. Several risk factors have been identified in relation to its development. It is more frequent in males, more likely to follow infections acquired in childhood than those acquired in adult life, and more likely to occur in patients with natural or acquired immune deficiencies. Chronic hepatitis B infection occurs in 90% of neonates or young infants, but in only 1–5% of immunocompetent adults. In countries where hepatitis B infection is common, the highest prevalence of HBsAg is found in young children, with steadily declining rates among older age groups. HBeAg has been reported to be more common in young than in adult carriers of hepatitis B, whereas the prevalence of anti-HBe

Table 3.2 Prevalence of hepatitis B

	Northern Europe Western Europe Central Europe North America Australia	Eastern Europe Mediterranean Former USSR Southwest Asia Central America South America	Parts of China Southeast Asia Sub-Saharan Africa
HBsAg	0.2–0.5%	2–7%	8–20%
Anti-HBs	4–6%	20–55%	70–95%
Neonatal infection	Rare	Frequent	Very frequent
Childhood infection	Infrequent	Frequent	Very frequent

seems to increase with age.

Survival of HBV is ensured by the reservoir of carriers, estimated to number over 300 million worldwide. The prevalence of carriers, particularly among blood donors, in northern Europe, North America and Australia is 0.1% or less; in central and eastern Europe up to 5%; in southern Europe, the countries bordering the Mediterranean, and parts of Central and South America the frequency is even higher; and in some parts of Africa, Asia and the Pacific region as many as 20% of the apparently healthy population may be HBsAg positive (Table 3.2). There is an urgent need to introduce methods of interruption of transmission. The management of chronic hepatitis B is complex, with personal, social and economic implications.

Biology of HBV

In addition to the human HBV, a number of similar viruses, which infect mammals and birds, have been described and the virus family has been named *Hepadnaviridae* (*hepa*-tropic DNA viruses). The viruses have a similar genetic organization and mode of replication and are characterized by a high degree of host specificity and tropism for the liver. Of the mammalian viruses, the *Woodchuck hepatitis virus* (WHV) and *Beechey Ground squirrel hepatitis virus* (GSHV) have been well characterized, the former being of interest as a model system for primary liver cancer because there is a high probability of progression to tumour for WHV-infected woodchucks. Of the avian viruses, the *Pekin Duck hepatitis B virus* (DHBV) has been well characterized and this animal model has been valuable in the elucidation of the hepadnavirus replication process. A

Heron hepatitis B virus (HHBV) has also been characterized but reports of hepadnaviruses infecting other species remain to be confirmed.

Structure of HBV

Electron microscopy of HBV-positive serum reveals three morphologically distinct forms of particle (Figure 3.8). The small, 22 nm spherical particles and tubular forms of roughly the same diameter are composed of the virus surface protein embedded in lipid and are synthesized in vast excess over the 42 nm, double-shelled virions. The latter comprise a 27 nm, electron-dense core surrounded by HBsAg that is distinct from the subviral particles in that pre-S1 epitopes are present (see below). The core or nucleocapsid consists of the genome surrounded by a second protein, hepatitis B core antigen (HBcAg). A third antigen, 'e' antigen (HBeAg), is found in soluble form in virus-positive sera and is related to the core antigen, as described below. The genome is DNA (Figure 3.9) and comprised of two strands held in a circular configuration by base-pairing at the 5' ends (cohesive end region). One of the strands is incomplete (usually 50–80% full length) and is associated with a polymerase which is able to fill in the single-stranded region when provided with suitable substrates.

The genomes of a variety of isolates of HBV have been cloned and the complete nucleotide sequences determined. Although there is some variation in sequence (up to 12% of nucleotides) between these isolates, the genetic organization and other essential features are conserved. The genome is around 3200 bp in length and analysis of the protein coding potential reveals four conserved ORFs, the prod-

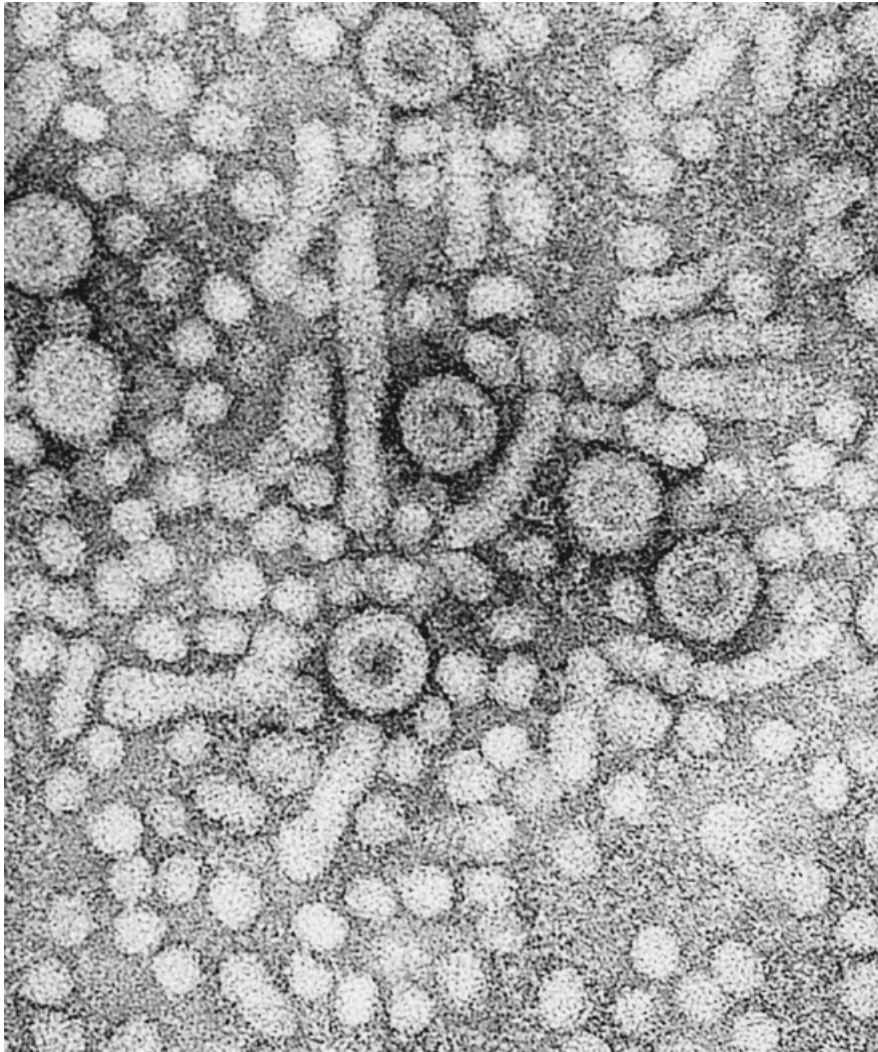

Figure 3.8 Electron micrograph of serum containing hepatitis B virus after negative staining. The three morphological forms of the antigen are shown: (1) small pleomorphic spherical particles 20–22 nm in diameter (hepatitis B surface antigen); (2) tubular structures (a form of the surface antigen); (3) the 42 nm double-shelled virions, with a core surrounded by the surface antigen. ($\times 300\,000$) (From Zuckerman, A.J. (1975) *Human Viral Hepatitis*. North Holland/American Elsevier, Amsterdam)

ucts of which are described below. These four ORFs are located on the same DNA strand and the strands of the genome have accordingly been designated plus (incomplete strand) and minus (complete strand), as shown in Figure 3.9. Other features include a motif of 11 bp which is directly repeated near to the 5' end of each strand of genomic DNA and plays an essential part in the replication strategy, two transcriptional enhancer elements, and binding sites for glucocorticoids and other cellular factors.

Hepatitis B Surface Antigen (HBsAg)

The major protein of HBsAg is 226 amino acids long and found in non-glycosylated (p24) and glycosylated (gp27) forms. It is encoded in the 3' half of the surface ORF and translated from the third of three in-phase initiation codons. Larger, pre-S proteins are translated utilizing the two upstream initiation codons; translation from the second results in two intermediate-sized glycoproteins (gp33 and

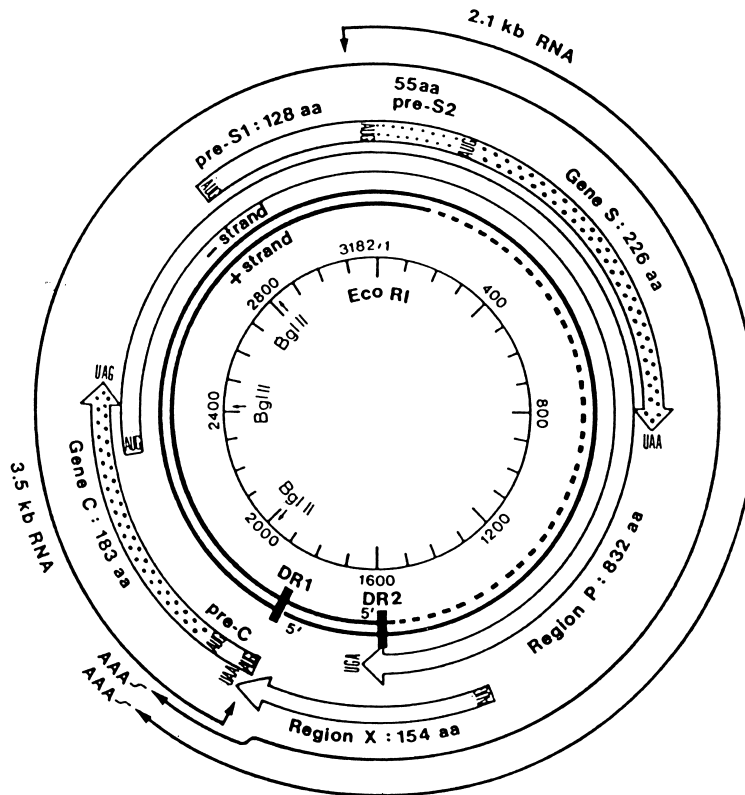

Figure 3.9 Structure and genetic organization of the HBV genome. The broad arrows surrounding the genome represent the four large open reading frames of the L (–) strand transcript. The number of amino acids (aa) encoded are indicated in each case. The two thin arrows surrounding the broad arrows represent the two major HBV mRNAs. The partial restriction map and the numbering of the nucleotides indicated on the inner circle correspond to the ayw3 genome. DR1 and DR2 are the directly repeated sequences involved in the replication of the genome. (From Tiollais P. *et al.* (1985) *Nature*, 317, 389–495. Macmillan, London)

gp36) with a 55 amino acid N-terminal extension, the pre-S2 domain. These pre-S2 proteins are minor components of virions and subviral particles. Translation of the entire ORF (pre-S1 + pre-S2 + S) gives rise to the largest proteins (p39 and gp42) which seem to be found predominantly in virions and perhaps the tubular, 22 nm forms. A domain within the pre-S1 region may be responsible for the attachment of the virus to the receptor on the hepatocyte. Synthesis of the pre-S1 protein also may act as a signal for virion assembly in the infected cell. Control of abundance of the major surface, pre-S2 and pre-S1 proteins seems to be at the transcriptional and translational level.

The subviral particles and the virion surface are composed of HBsAg anchored in a lipid bilayer derived from the host cell endoplasmic reticulum. The major antigenic determinant on the particles is

the common, group-specific antigen, *a*, which is believed to form a 'double loop' structure (amino acids 124–137 and 139–147) on the surfaces of the virions and subviral particles. The formation of anti-*a* antibodies following vaccination seems to be sufficient to confer protective immunity. The major HBsAg protein also carries a pair of mutually exclusive subdeterminants, *d* or *y* and *w* or *r*, which, in each case, seem to correlate with variation at single amino acid positions (122 and 160, respectively). Thus, four principal phenotypes of HBsAg are recognized—*adw*, *adr*, *ayw* and, more rarely, *ayr*—and these show differing geographical distribution. For example, in northern Europe, the Americas and Australia subtype *adw* predominates, while *ayr* occurs in a broad zone that includes northern and western Africa, the eastern Mediterranean, eastern Europe, northern and central Asia, and the Indian

subcontinent. Both *adw* and *adr* are found in Malaysia, Thailand, Indonesia and Papua New Guinea, whereas subtype *adr* predominates in other parts of southeast Asia, including China, Japan and the Pacific Islands. The subtypes provide useful epidemiologic markers of HBV. Unusual variants which lack the group specific antigen, *a*, may be selected by antibody in immunized infants infected perinatally and in persistently infected individuals following treatment with hepatitis B immune globulin or a natural antibody response.

Surface variants of HBV were first described in Italy infecting children and adults in the presence of specific hepatitis B surface antibodies (anti-HBs) several months after successful immunization with two generally licensed hepatitis B vaccines given with and without hepatitis B immunoglobulin (Carmen *et al.*, 1990). Epitope mapping of HBsAg in these patients revealed that monoclonal antibodies which normally bind to the *a* determinant failed to bind, suggesting that it was not present or that it was masked. Anticore antibody was found in these patients. Further work established that, in at least one case, the infection was caused by a variant with a mutation leading to a substitution of arginine for glycine at amino acid position 145 in the immunodominant domain. This change, which seems to have been selected by antibody, has since been observed independently in the USA (McMahon *et al.*, 1992), Singapore (Harrison *et al.*, 1991) Japan and elsewhere. Other mutations have been described, leading to altered HBsAg which escapes neutralization by anti-HBs, but the arginine for glycine substitution at amino acid position 145 seems to be the most common (Oon *et al.*, 1995).

Hepatitis B Core Antigen and Other Viral Proteins

The core protein (p22) is the major component of the nucleocapsid and includes an arginine-rich domain at the C-terminus which presumably interacts with the viral nucleic acid. The importance of antibodies to this protein (anti-HBc) in diagnosis of infection is discussed below. The core protein is translated from the second initiation codon in the core ORF (Figure 3.9). Translation from the upstream initiation codon yields a precursor protein (p25) which is processed to yield HBeAg. The

precure region, between the two initiation codons, encodes a signal sequence which directs p25 to the endoplasmic reticulum, where it is cleaved by a cellular signal peptidase. HBeAg is secreted following further proteolysis which removes the C-terminal domain. HBeAg is also expressed on the surface of the infected hepatocyte and is a major target for the cellular immune system. HBeAg is not an essential protein of the virus but it may cross the placenta during pregnancy, tolerizing the fetus and increasing the probability that a perinatal infection will progress to chronicity. Variants of HBV with mutations in the precure region (precure mutants) and which are defective for the synthesis of HBeAg are discussed below.

The P ORF, which overlaps the other three, encodes the viral polymerase. This enzyme has both DNA- and RNA-dependent activities and the predicted amino acid sequence has been shown to have homology with retroviral reverse transcriptases. The polymerase protein also acts as the primer for minus-strand DNA synthesis and has an 'RNase H' activity which degrades the RNA pregenome during minus-strand synthesis. The fourth ORF has been termed X because the function of its product was originally obscure. It is now known that this protein acts as a transcriptional transactivator and may enhance the expression of the other viral proteins. Experiments using the woodchuck model (see below) confirm that a functional X gene is required for the establishment of infection *in vivo*.

Replication of the Virus

The essential elements of the replication strategy of the hepadnavirus genome were elucidated by Summers and Mason (1982) in an elegant series of experiments utilizing subviral cores isolated from DHBV-infected duck hepatocytes. The hepadnaviruses are unique among animal DNA viruses, in that they replicate through an RNA intermediate (Figure 3.10). On infection of the hepatocyte, the viral DNA is uncoated and converted to a covalently closed circular (supercoiled) form in the nucleus, and this is the template for transcription of the viral RNAs. There are at least four viral promoters and all of the RNAs are 3' coterminal, being polyadenylated in response to a signal in the core ORF. The largest RNAs are greater than genome length

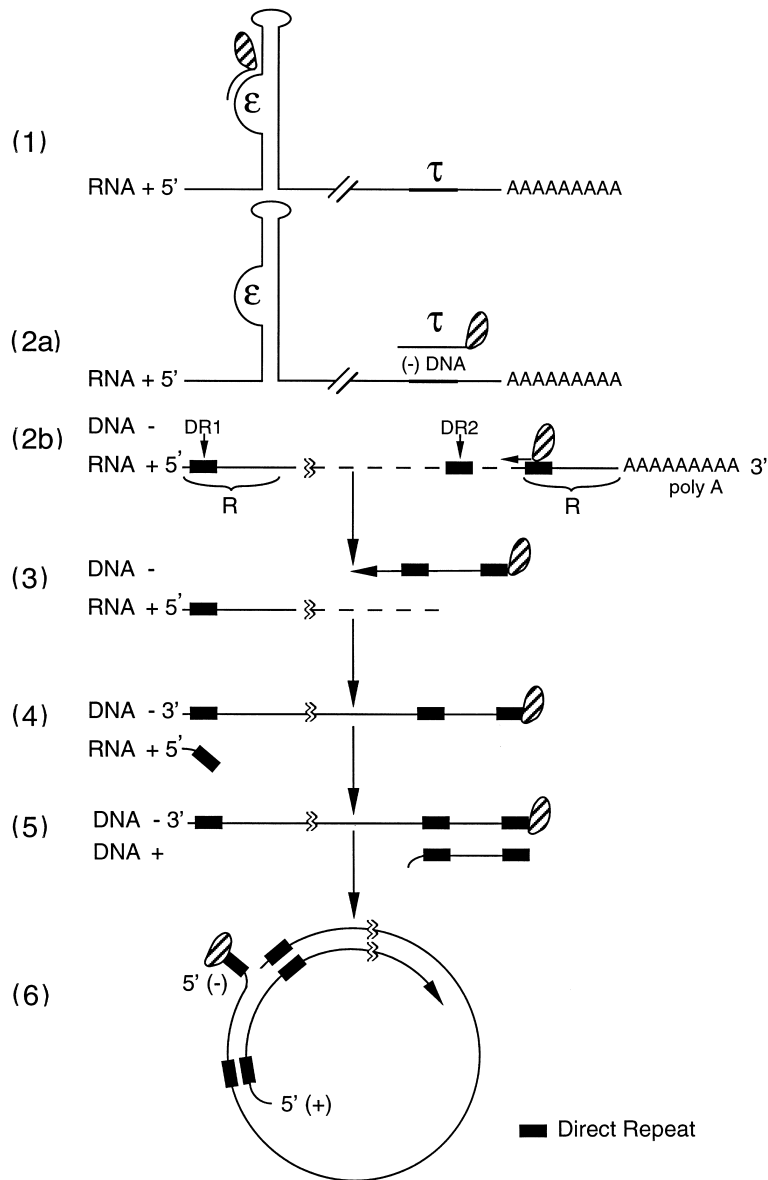

Figure 3.10 The replication strategy of the HBV genome. (1) Priming of minus (-) strand synthesis by the terminal protein (cross-hatched) on the bulge of the ϵ signal near the 5' end of 3.5 kb pregenomic RNA. (2a) Translocation of the primer to a position (τ) near the 3' end of the RNA template. (2b) The template shown as a linear structure, solid boxes indicate the direct repeat (DR) sequences and R the redundancy of the RNA. (3) Minus (-) strand DNA synthesis by reverse transcription with concomitant hydrolysis of the RNA template (RNase H-like activity). (4) and (5) Translocation of the remaining 5' oligoribonucleotide from DR1 to DR2 and priming of plus (+) strand DNA synthesis. (6) Circularization of the genome through the redundancy in the minus (-) strand and continuation of plus (+) strand synthesis. (Modified from Lien *et al.* (1986) *Journal of Virology*, **57**, 229–236. American Society of Microbiology, Washington)

(approximately 3500 nucleotides) and, while some act as mRNAs for the synthesis of HBcAg, HBsAg and the viral polymerase, a subset are intermediates in the synthesis of progeny genomes. Binding of the

polymerase to secondary structure at the 5' end (epsilon signal, ϵ) of the pregenome leads to packaging into immature viral cores in the cytoplasm (Figure 3.10, step 1). The N-terminal domain of the viral

polymerase acts as the primer for minus-strand DNA synthesis and, following synthesis of a four nucleotide nascent strand, translocates to a complementary four base sequence (τ) near to the 3' end of the RNA template (Figure 3.10, steps 2a and 2b). This protein remains covalently attached to the 5' end of that strand in the mature virion. Minus-strand synthesis proceeds by 'reverse transcription' of the pregenome by the viral polymerase with concomitant degradation of the template (RNase H-like activity, Figure 3.10, step 3). The remaining oligoribonucleotide (which was the 5' end of the pregenome) is at the position of the direct repeat, DR1 (Figure 3.10, step 4), and is now believed to translocate to the other copy of the direct repeat, DR2, on the minus strand and to prime synthesis of the plus strand (Figure 3.10, step 5). The minus strand has a short terminal redundancy (approximately eight nucleotides) which permits the circularization of the genome as the plus strand is synthesized (Figure 3.10, step 6). Completion of the core presumably starves the polymerase of precursor nucleoside triphosphates leaving the plus strand incomplete. The cores are then coated with HBsAg to form mature virus particles.

HBV Infection and Chronic Hepatitis B

Following HBV infection, the first marker to appear in the circulation is HBsAg, which becomes detectable 2–8 weeks prior to biochemical evidence of liver damage or the onset of jaundice (Figure 3.11). Next to appear are the markers of the virion, such as the virus-specific DNA polymerase activity and the viral DNA, along with the soluble antigen, HBeAg. Antibody to the core (anti-HBc) is detectable 2–4 weeks after the appearance of the surface antigen, this persists throughout the infection and after recovery. In acute infections, clearance of the virus is marked by seroconversion with the disappearance of HBeAg and the appearance of antibodies to it (anti-HBe). Later during convalescence, HBsAg also disappears with the production of anti-surface antibody (anti-HBs).

In the case of 2–10% of infected adults, and a much larger percentage of children infected perinatally, the immune system fails to clear virus replication and the infection persists. Chronic hepatitis B may be divided into two phases (Figure 3.12).

In the first, high levels of virus replication occur and the patient is seropositive for markers of the virion and for HBeAg. Although HBeAg correlates with the presence of the virus, in some cases when virus replication declines to very low levels or when precore mutants are present, seroconversion to anti-HBe may occur without clearance of the virus. Therefore, direct tests for the virus are more reliable for establishing infectivity; for example, detection of viral DNA by hybridization or the PCR. During the first phase of chronicity, replicative forms of the HBV genome may be detected in the liver by Southern hybridization of DNA extracted from biopsy material (Figure 3.13, Lane A7). This replicative phase may persist for years, and even lifelong in individuals infected perinatally and whose immune systems are tolerant. More usually, levels of virus replication decline gradually until this is eliminated with seroconversion to anti-HBe. Rarely, there will be seroconversion also to anti-HBs, but in many cases, HBsAg will persist in the absence of virus replication. Examination of liver biopsies from patients in this second phase of chronicity often reveals that HBV DNA is now integrated chromosomally in the hepatocytes (Figure 3.13, lane B) and HBsAg seems to be produced following transcription of this integrated DNA. In fact, integration of virus DNA into the hepatocyte chromosomes seems to take place throughout the period of virus replication, and expansion of clones of such cells may be a stage in progression to neoplasia (see below). Integration of the viral genome is not believed to be required for replication of the virus and may, in fact, be the result of an abortive infection. Although replicative and integrated HBV DNA may sometimes be observed in an individual biopsy specimen (Figure 3.13, lane C) it is not clear that both may be present in the same cell.

Occurrence of HBV in Extrahepatic Tissues

As stated above, hepadnaviruses are essentially hepatotropic and it is not clear that they can replicate in other tissues. Sensitive hybridization techniques have, however, enabled the detection of viral DNA at other sites, particularly in peripheral leucocytes, the bone marrow and spleen. Viral DNA in white blood cells usually occurs as monomeric or

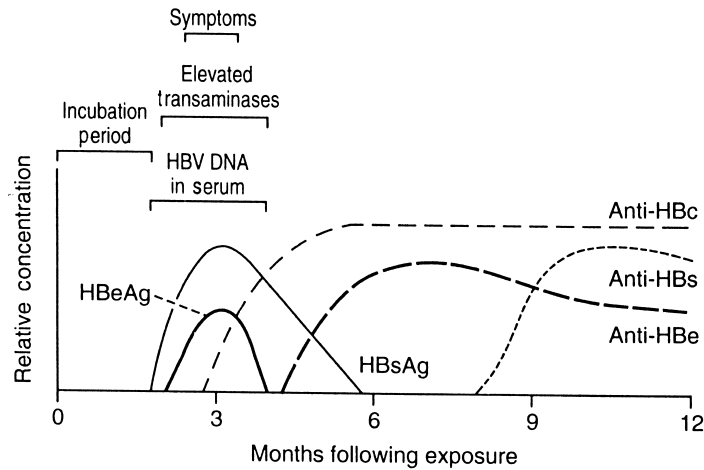

Figure 3.11 Serological profile of acute, resolving hepatitis B

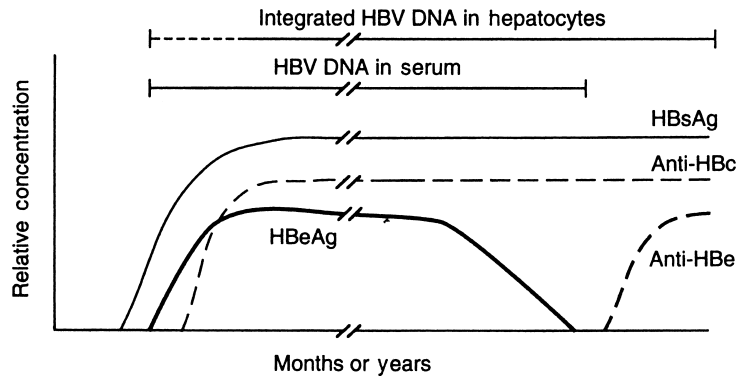

Figure 3.12 Serological profile of chronic hepatitis B with seroconversion

multimeric episomes or, rarely, may be integrated, and there have been reports that replicative forms also may be found. These findings have implications for virus transmission and for the possible recurrence of hepatitis B in patients who have cleared virus replication from the liver.

Diagnosis

The most widely used test for diagnosis of hepatitis B is assay for HBsAg. Current immunoassays for HBsAg detect 100–200 pg HBsAg per millilitre of serum, corresponding to roughly 3×10^7 particles per millilitre. Most HBeAg positive carriers have more than 10^5 genomes per millilitre of serum. Immunity after infection with HBV is characterized by

the presence of anti-HBs together with anti-HBc in serum. Immunity after vaccination is characterized by the presence of anti-HBs alone.

Assay of HBV DNA

The dot blot hybridization test for serum HBV DNA correlates with infectivity, and is an important means of determining the presence of viral genomes and of determining response to antiviral therapy. Amounts of HBV DNA are expressed in picograms per millilitre, or alternatively, genome equivalents per millilitre. The usual range of sensitivity is 0.1–1 pg or 10^5 genome equivalents per millilitre of serum. At least $10^{3.5}$ virions have to be present in a specimen to be detected by dot blot assay.

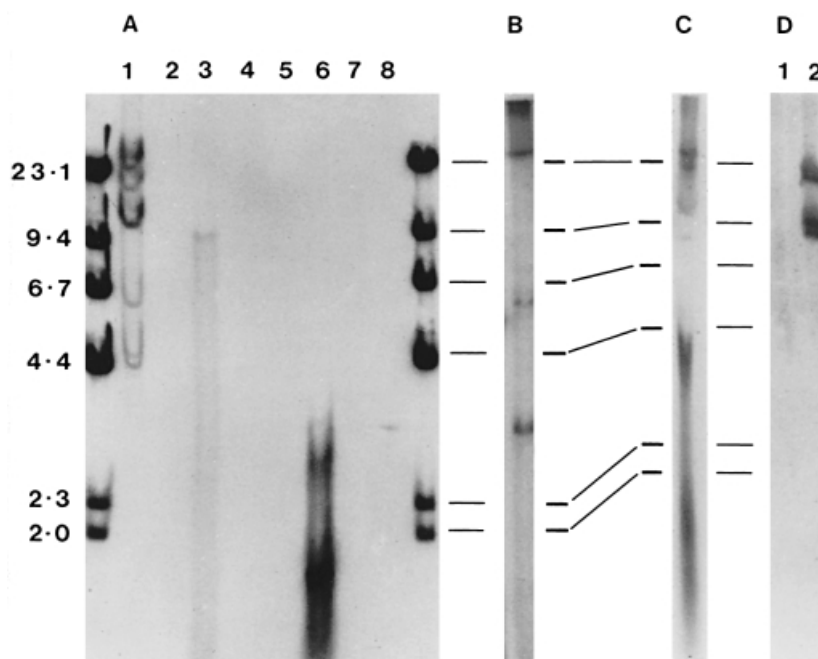

Figure 3.13 Analysis of the state of HBV DNA in the hepatocyte using the Southern blot hybridization technique. Lane A1: integration of HBV DNA in the PLC/PRF/5 cell line. Lane A6: HBV DNA replicative intermediates in the liver biopsy from an HBeAg-positive patient. Lane B: integration of HBV DNA in an anti-HBe, HBsAg-positive patient without tumour. Lane C: biopsy from an HBeAg-positive patient with both replicative forms and integrated HBV DNA. Lanes D: Biopsies from an anti-HBe, HBsAg-positive patient with primary liver cancer. 1: Biopsy from the non-tumorous part of the liver. 2: Biopsy from the tumour showing integration of HBV DNA at three sites. All DNA samples were digested with the restriction enzyme Hind III. The leftmost lane shows radioactively labelled Hind III fragments of bacteriophage λ DNA as size markers—sizes are given in kilobase pairs alongside. (Modified from Harrison *et al.* (1986) *Journal of Hepatology*, 2, 1–10. Elsevier Science Publishers BV, Amsterdam)

bdNA assay for HBV DNA. A new chemoluminescent assay for HBV DNA based on oligonucleotide amplification of a signal rather than target appears to be more sensitive than dot-blot hybridization. The PCR for HBV DNA permits the detection, cloning and sequencing of HBV genomes from such patients. It is at least 10^4 times more sensitive than dot-blot hybridization assays for HBV DNA.

Acute Hepatitis B

A simplified guide to the interpretation of the test results is shown in Table 3.3. Detection of HBsAg is the frontline assay for infection and used widely for screening, for example, in transfusion centres.

The diagnosis of acute hepatitis B generally rests upon the finding of HBsAg and IgM antibody to hepatitis B core antigen (anti-HBc) in the serum of a patient with clinical and serum biochemical evidence of acute hepatitis. HBsAg is the first marker

to appear in serum, followed by HBV DNA, HBeAg and DNA polymerase, and anti-HBc (Krogsgaard *et al.*, 1985). Levels of HBV DNA usually reach 10^5 – 10^8 genome equivalents per millilitre with the onset of symptoms, after which the levels decrease. In contrast, in patients who develop chronic hepatitis B, levels of HBV DNA remain high. A positive IgM anti-HBc test typically distinguishes acute from chronic hepatitis B. By the time the patient consults a physician, HBV DNA and HBeAg are often no longer detectable in serum. The loss of HBeAg is a sign that the patient will clear HBsAg. HBsAg may be present only transiently in serum. The only evidence of infection may therefore be the presence of IgM anti-HBc or subsequent development of anti-HBc and anti-HBs. Anti-HBs may be quantified and the test is valuable in determining the outcome of immunization.

Serum alanine aminotransferase (ALT) concentrations typically rise in acute hepatitis B. Serum bilirubin concentrations increase in proportion to

Table 3.3 Interpretation of results of serological tests for hepatitis B

HBsAg	HBeAg	Anti-HBe	Anti-IgM	HBc IgG	Anti-HBs	Interpretation
+	+	-	-	-	-	Incubation period
+	+	-	+	+	-	Acute hepatitis B or persistent carrier state
+	+	-	-	+	-	Persistent carrier state
+	-	+	±	+	-	Persistent carrier state
-	-	+	±	+	+	Convalescence
-	-	-	-	+	-	Recovery
-	-	-	+	-	-	Infection with HBV without detectable HBsAg
-	-	-	-	+	-	Recovery with loss of detectable anti-HBs
-	-	-	-	-	+	Immunization without infection. Repeated exposure to antigen without infection, or recovery from infection with loss of anti-HBc

the severity of hepatic damage. During this phase, IgM anti-HBc in serum correlates with active hepatitis in patients. Antibodies to pre-S components appear early in the disease, and correlate with the disappearance of serological markers of HBV replication, suggesting a role in immunological clearance of HBV (Cupps *et al.*, 1990). Immune complexes may be responsible for some of the manifestations of the acute disease. A mild decrease in serum C3 and C4 concentrations occurs in acute hepatitis B and may reflect antigen-antibody complex formation. Autoantibodies, including abnormalities in rheumatoid factor, and anti-nuclear and anti-smooth muscle antibodies are also detectable in acute hepatitis. In fulminant hepatitis extremely rapid clearance of HBeAg and HBsAg may occur.

Chronic Hepatitis B

Many carriers are detected through routine screening for HBsAg or the presence of abnormal liver function tests. Older patients may present for the first time with complications of cirrhosis, or even hepatocellular carcinoma. Typically the levels of serum aminotransferases are elevated in patients with HBeAg, HBV DNA-positive chronic hepatitis, but some patients may have normal values. The levels of aminotransferases fluctuate with time. A spontaneous remission in disease activity may occur in approximately 10–15% of HBeAg-positive carriers per year, characterized by disappearance of detectable (by molecular hybridization) HBV DNA

from serum, followed by loss of HBeAg. This may occur following a sudden, asymptomatic increase in serum aminotransferases. Once HBeAg is cleared, the disease remits temporarily and serum aminotransferases become normal.

Natural History of Chronic Hepatitis B

Chronic hepatitis B generally lasts for many years, but may not necessarily be lifelong. Some patients with chronic hepatitis B may spontaneously seroconvert from being HBeAg positive to anti-HBe positive and enter a phase of remission with an improvement in serum aminotransferases, albeit that they remain HBsAg positive. The term healthy hepatitis B carriers has been used for these persons, but the term is somewhat inappropriate, as they are at risk of reactivation of active virus replication, and, if cirrhosis has developed, they may ultimately develop hepatocellular carcinoma, in the face of relatively low levels of viraemia. Recent retrospective studies have focused on survival in compensated cirrhosis due to hepatitis B. In a European multicentre longitudinal study to assess the survival of 366 HBsAg-positive compensated cirrhosis, death occurred in 23% of patients, mainly due to liver failure or hepatocellular carcinoma. The cumulative probability of survival in this cohort was 84% and 68% at 5 and 10 years, respectively. The worst survival was in HBeAg and HBV DNA-positive subjects (Fattovich *et al.*, 1997).

As stated above, a number of patients have ongo-

ing virus replication without detectable HBeAg, and often in the presence of anti-HBe (Hadziyannis *et al.*, 1983). It is now known that such patients frequently are infected with variants of HBV with mutations in the precore region and which cannot synthesize HBeAg (Carman *et al.*, 1989). The majority of these patients are anti-HBe positive and may have been infected initially with a mixture of wild-type and variant virus, with clearance of the wild type on seroconversion to anti-HBe. Precore variants may be selected during the process of seroconversion to anti-HBe when hepatocytes expressing HBeAg are targeted for lysis by cytotoxic T cells. Precore mutants can be detected in patients with fulminant hepatitis B (Carman *et al.*, 1991) but it is controversial whether infection with these variants *ab initio*, in the absence of wild type virus, often leads to acute liver failure. Not all patients with fulminant hepatitis B are infected with precore mutants, and other mutations, such as in the core promoter, as well as host factors, may be important (Sterneck *et al.*, 1996).

Pathogenesis of Hepatitis B Infection

HBV is not cytopathic to hepatocytes under most circumstances. Host immunity plays an important role in cellular injury and there is little correlation between the severity of the illness and the level of HBV replication. Patients with a poor T cell response may have high concentrations of virus in liver and the mildest disease. The development of chronic infection is due to a failure of an adequate immune response, but the immune response is also responsible for disease pathogenesis during chronic infection. The subsequent expression of the disease involves a poorly understood interplay between viral and host factors. The nucleocapsid antigens (HBcAg and HBeAg) expressed on the cell membrane contain important targets of the immune response and cytolytic T cells in acute hepatitis B.

In acute hepatitis B, intense lysis of hepatocytes occurs. Immune lysis is believed to eradicate hepatitis B. However, experimental studies in the transgenic mouse model suggest that HBV replication may also be reduced by a complex interplay of a cytotoxic T cell response, apoptosis and down-regulation of hepatitis B gene expression by several inflammatory cytokines. An association of MHC

class II alleles (DRB*1302) with lack of persistent HBV infection has been reported (Thursz *et al.*, 1995). In fulminant hepatitis, extremely rapid clearance of HBeAg and HBsAg may occur.

The elimination of virus-infected hepatocytes is dependent on the recognition by cytotoxic T cells of viral determinants, in association with HLA proteins on the infected cells. Data derived from most experimental systems suggest that an acute, polyclonal and vigorous cytolytic T cell response usually occurs in acute symptomatic icteric hepatitis B and that patients with acute self-limiting hepatitis B develop a polyclonal HLA class I restricted, cytotoxic T cell response against numerous epitopes in the HBV envelope, nucleocapsid and polymerase proteins. Several HLA-A2 restricted cytotoxic T cell epitopes have been defined.

The failure to eradicate HBV reflects an inadequate immune response to the virus, but the precise impairment of humoral and cellular immunity that determines the development and outcome of hepatitis B has not been characterized. Persistent infection is an unusual outcome in those patients with acute icteric hepatitis B and the mechanisms that lead to viral persistence are not well understood. In neonates, specific suppression of the cell mediated immune response may favour infection, perhaps because of intrauterine exposure to HBeAg inducing tolerance to epitopes that are usually the target of the cytotoxic T cell response at a time when the immune system is ontogenically immature. Clonal deletion of HBV-specific T cells may occur as a consequence of transplacental infection of the developing fetus or transplacental passage of viral antigens. In contrast to the vigorous polyclonal class I and class II-restricted T cell response that can be identified in patients with acute icteric hepatitis B, in chronic disease the response in peripheral blood is relatively weak and focused, and insufficient to clear replicating virus.

Other mechanisms may also operate to prevent clearance of HBV: mutations abrogating the recognition of the wild-type hepatitis, including the natural variants of the HBcAg 18–27 core epitope that interfere with the recognition of the wild type epitope and act as T cell receptor antagonists (Bertoletti *et al.*, 1994). There is some evidence of a failure of interferon production in patients with chronic hepatitis B.

Recent experiments indicate that, although many patients will not have a discernible cytotoxic T cell

response, a proportion do mount a 'secondary' immune response, associated with seroconversion to anti-HBe, and at least a temporary remission in disease. A proliferative T cell response is evident in active disease. In addition, an HLA-restricted cytotoxic T cell response can be detected around the time of anti-HBe seroconversion during spontaneous or interferon-induced HBeAg clearance, or when there has been an exacerbation of the disease associated with an increase in HBV DNA. Cytokines also are released in acute and chronic hepatitis. Necrosis of hepatocytes may also be amplified by antigen non-specific release of cytokines, rather than by a directed cytotoxic T cell response. In transgenic mice, non-cytolytic mechanisms have been observed, including the suppression of viral gene expression and replication by a post-transcriptional mechanism mediated by γ -interferon, tumour necrosis factor α (TNF α) and interleukin(IL)-12 (Tsui *et al.*, 1995; Cavanaugh *et al.*, 1997). Experiments in mice have suggested that a predominance of HBeAg-specific, T_H2-type cells may contribute to chronicity in HBV infection (Milich *et al.*, 1995a).

Prevention and Control of Hepatitis B

Passive Immunization

Hepatitis B immunoglobulin (HBIG) is prepared from pools of plasma with high titres of hepatitis B surface antibody and may confer temporary passive immunity under certain defined conditions. The major indication for the administration of HBIG is a single acute exposure to HBV, such as occurs when blood containing HBsAg is inoculated, ingested or splashed on to mucous membranes and the conjunctiva. The optimal dose has not been established but doses in the range of 250–600 iu have been used effectively. HBIG should be administered as early as possible after exposure and preferably within 48 hours, usually 3 ml (containing 200 iu of anti-HBs per ml) in adults. It should not be administered 7 days or more after exposure. It is generally recommended that two doses of HBIG should be given 30 days apart.

Results following the use of HBIG for prophylaxis in babies at risk of infection with HBV are encouraging if the immunoglobulin is given as soon as possible, and certainly within 12 hours of birth, and

the chance of the baby developing the persistent carrier state is reduced by about 70%. More recent studies using combined passive and active immunization indicate an efficacy approaching 90%. The dose of HBIG recommended in the newborn is 1–2 ml (200 iu of anti-HBs per ml).

Active Immunization

Failure to grow HBV in cell culture directed attention to the use of other sources of antigen for active immunization. Since recovery from acute hepatitis B usually is associated with an anti-HBs response and consequent immunity, an obvious approach was to use HBsAg as an immunogen in vaccine formulations. First-generation vaccines, which are still in use in some countries, are prepared from the plasma of HBsAg-positive individuals by purification and inactivation of 22 nm spherical surface antigen particles. Trials of protective efficacy in high-risk groups in the early 1980s demonstrated the value of the vaccines and their safety. These vaccines have been superseded in most countries by preparations of HBsAg expressed in yeast or mammalian cells (recombinant vaccines). Local reactions reported after immunization with these preparations have been minor, occurring in less than 20% of immunized individuals, and consisted of slight swelling and reddening at the site of inoculation. Temperature elevations of up to 38°C were observed in only a few individuals.

HBV vaccines currently used in the UK and elsewhere in the West are prepared from yeast (*Saccharomyces cerevisiae*). The region of the surface ORF specifying the 226 amino acids of the major surface protein, but without the pre-S sequences, was placed under the control of a yeast promoter in a plasmid which also contained components necessary for replication and maintenance in yeast cells. The plasmid, which was constructed using *E. coli*, was then used to transform yeast protoplasts. The transformed yeast, which synthesizes HBsAg, is grown from seed stocks in fermenters. The cells are harvested and disrupted mechanically and the surface antigen is purified by a combination of precipitation steps, ultrafiltration, gel permeation and ion exchange chromatography. The purified antigen is sterilized by membrane filtration and adsorbed to buffered aluminium hydroxide.

The emergence of variants of HBV which are not neutralized by vaccine-induced anti-HBs, as de-

scribed above, is of major concern. Horizontal spread of these viruses has not yet been reported but remains a possibility. If the number of potential variants is limited it may be possible to include these in future formulations of hepatitis B vaccine. It seems that the mutation affecting amino acid residue 145 (glycine to arginine) is the most common but variants with other changes are being investigated (Oon *et al.*, 1995).

There has been some interest in including pre-S sequences in recombinant hepatitis B vaccines to potentiate the immunogenicity of HBsAg and address the problem of non-responsiveness (Zuckerman, 1996). Enhancement of the immunogenicity of the pre-S region of HBsAg has been demonstrated in mice, using chemically synthesized peptides (Milich *et al.*, 1985). The immune response to the pre-S2 region was shown to be regulated by H-2 linked genes which are distinct from those which regulate the response to the S region. It was also demonstrated that immunization of a 'non-responder' murine strain with particles which contain both S and pre-S2 can circumvent non-responsiveness. Furthermore, HBV is believed to attach to the hepatocyte receptor through a domain in the pre-S1 protein and antibodies to that domain are neutralizing (Neurath *et al.*, 1986). A variety of vaccines containing pre-S sequences are now undergoing clinical trial and there are some indications that the rate of non-responsiveness may be lower than with vaccines containing S alone (Zuckerman *et al.*, 1997). It is not clear whether the inclusion of extra antigenic domains will circumvent the problem of antibody escape variants.

Site of Injection for Vaccination

Hepatitis B vaccination should be given in the upper arm or the anterolateral aspect of the thigh and not the buttock (Zuckerman *et al.*, 1992). There are over 100 reports of unexpectedly low antibody seroconversion rates after hepatitis B vaccination using injection into the buttock. In one centre, a low antibody response was noted in 54% of healthy adult health-care personnel. Many studies have since shown that the antibody response rate was significantly higher in centres using deltoid injection than centres using the buttock. On the basis of antibody tests after vaccination, the advisory committee on immunization practices of the Centers for

Disease Control and Prevention, USA, recommended that the arm be used as the site for hepatitis B vaccination in adults, as have the Departments of Health in the UK.

Combined Immunoprophylaxis

Whenever immediate protection is required, as, for example, for infants born to HBsAg-positive mothers (see above) or following transfer of an individual into a 'high-risk' setting or after accidental inoculation, active immunization with the vaccine should be combined with simultaneous administration of HBIG at a different site. It has been shown that passive immunization with up to 3 ml (200 iu of anti-HBs per ml) of HBIG does not interfere with an active immune response. A single dose of HBIG (usually 3 ml for adults; 1–2 ml for the newborn) is sufficient for healthy individuals. If infection has already occurred at the time of the first immunization, virus multiplication is unlikely to be inhibited completely, but severe illness and, most importantly, the development of the carrier state of HBV may be prevented in many individuals, particularly in infants born to carrier mothers.

Indications for Immunization

The current indications for the use of hepatitis B vaccines in the UK are given below. Many countries, including the USA and Italy, introduced universal immunization for infants in 1992. The World Health Organization recommended a decade ago that universal immunization should be in place in areas with a prevalence of HBsAg greater than 8% by 1994 and in all countries by 1997, with integration of hepatitis B vaccine into the Expanded Programme of Immunization (EPI). These targets were not met and universal immunization of infants worldwide remains a goal.

In 1996 the Department of Health and other government offices in the UK recommended immunization for the following risk groups:

- Babies born to mothers who are chronic carriers of hepatitis B virus or to mothers who have had acute hepatitis B during pregnancy. In addition, babies born to mothers who are HBeAg positive, who are HBsAg positive without e markers (or where HBeAg/anti-HBe status has not been determined), or who have had acute hepatitis B

during pregnancy should receive HBIG as well as active immunization. Currently, vaccine without HBIG is recommended for babies born to mothers who are HBsAg positive but known to be anti HBe positive.

- Parenteral drug misusers.
- Close family contacts of a case or carrier. Sexual contacts of patients with acute hepatitis B should also receive HBIG.
- Families adopting children from countries with a high prevalence of hepatitis B, particularly some countries in eastern Europe, southeast Asia and South America.
- Haemophiliacs (and others receiving regular blood transfusions or blood products, including carers responsible for the administration of such products).
- Patients with chronic renal failure. Higher doses of vaccine may be required in those who are immunocompromised.
- Health-care workers, including students and trainees.
- Staff and students of residential accommodation for those with severe learning disabilities.
- Other occupational risk groups, including certain members of the emergency and prison services.
- Inmates of custodial institutions.
- Those travelling to areas of high prevalence.

Despite the availability of a vaccine, infection persists worldwide. In populous regions where mass immunization has not started, there has not been a significant decline in HBsAg carrier rates, and therefore the carrier pool has increased with the increase in population. None the less, notable successes through vaccination have emerged, in particular in Taiwan and Alaska. In Taiwan, the long awaited impact of vaccination on the risk of hepatocellular carcinoma has been discernible (Chang *et al.*, 1997).

Antiviral Therapy

Alpha interferon. Alpha interferons are naturally occurring intercellular signalling proteins used therapeutically for their properties of inducing an antiviral state in cells, inhibiting cellular proliferation and immunomodulation. Several α -interferons, including HuIFN- α -N1 (Wellferon), rIFN- α -2b (Intron A), and rIFN- α -2a, (Roferon-A) have been licensed for the treatment of chronic hepatitis

B. These therapeutic preparations of type I interferons consist either of a mixture of interferon species derived from virus-stimulated Namalwa cells (Wellferon), or recombinant DNA-produced single-component α -interferon species. All are administered parenterally, either intramuscularly or subcutaneously, but can be given intravenously for patients with bleeding disorders. All type 1 interferons share a common pattern of biological effects that begin with binding of the interferon to the cell surface receptor. Binding is followed by activation of tyrosine kinases, which leads to the production of several interferon-stimulated gene products. The interferon-stimulated gene products are responsible for the pleiotropic biological effects of type-1 interferons including antiviral, antiproliferative and immunomodulatory effects, cytokine induction and HLA class I and class II regulation, macrophage activation and regulation of natural killer and cytotoxic T cells. Examples of interferon-stimulated gene products include 2', 5'-oligoadenylate synthetase (2', 5'-OAS), β_2 -microglobulin and the human MXa homologue.

Alpha interferon is not indicated for acute icteric hepatitis B. Although non-specific symptoms may be improved, there is no evidence that antiviral therapy accelerates healing or clearance of virus or that early treatment with interferon prevents the development of chronic disease. Low levels of viral replication are found in patients with fulminant hepatitis B, suggesting that the pathogenesis of the disease is due to an exaggerated immune response to HBV, and α -interferon has not been found to be beneficial in these severely ill patients.

Treatment of chronic hepatitis B is targeted at patients with active disease and viral replication, preferably at a stage before signs and symptoms of cirrhosis or significant injury have occurred (Dusheiko *et al.*, 1985). Eradication of the infection is possible in only a minority of patients. Permanent loss of HBV DNA (undetectable by molecular hybridization) and HBeAg, and normalization of the serum aminotransferases are considered a response to antiviral treatment, as this result is associated with an improvement in necro-inflammatory damage and reduced infectivity. It is possible, but unproven, that the accompanying reduction in histological chronic active hepatitis lessens the risk of cirrhosis and hepatocellular carcinoma (Niederau *et al.* 1996).

Approximately 35–40% of HBeAg-positive pa-

tients are treated effectively by α -interferon, at a dose of 9–10 million iu three times weekly (5 million daily in the USA) for 4–6 months. Response rates tend to be higher in carriers with higher baseline serum aminotransferase levels. The subclinical exacerbation of the hepatitis and increases in serum aminotransferases frequently seen in responders suggest that interferon acts by augmenting the immune response to HBV, perhaps triggered by the inhibition of viral replication, the effects of interferon on cytotoxic T cells, and the upregulation of MHC class I display. Sustained loss of HBeAg generally is associated with histological reduction in inflammation. Longer term follow-up of responders has shown that up to 65% of those who lose HBeAg become HBsAg negative (Korenman *et al.*, 1991; Lau *et al.*, 1997). Although parameters that predict responsive patients are difficult to characterize fully, those carriers with elevated pretreatment serum aminotransferase levels, with chronic active hepatitis, lower serum HBV DNA, females, those negative for anti-HIV, those with a history of hepatitis, Caucasians with more recent onset of chronic hepatitis B, and with IgM anti-HBc, may respond more favourably. Although these factors provide some predictive information, none of these criteria are absolute.

Alpha interferon also has been used to treat patients after induction and subsequent withdrawal of corticosteroids. Serum aminotransferases may increase in a proportion of patients as corticosteroids are withdrawn. The initial pretreatment may thus 'prime' patients, thus increasing the efficacy of α -interferon. (Perillo *et al.*, 1988; 1990).

Patients who are anti-HBe positive but who have HBcAg in hepatocytes and histological chronic active hepatitis due to infection with HBV 'precore mutants', which do not synthesize HBeAg, may have severe disease. In parts of Europe, and elsewhere, disease caused by this variant of HBV is more common than disease caused by the 'wild type' (HBeAg-positive chronic hepatitis). Approximately 10–25% of patients have long term responses to treatment doses of 9–10 million thrice weekly for 6–12 months, as relapse rates tend to be high in these patients (Brunetto *et al.*, 1989).

Children who are infected perinatally, and have mild disease activity, respond poorly to interferon treatment (Lok *et al.*, 1989). Conversely, children with active disease and high serum aminotransferases respond to interferon therapy similarly to

adults and usually accept treatment reasonably well (Ruiz-Moreno *et al.*, 1990). The appropriate dose of interferon in children is 3 mu m^{-2} three times weekly for 4 months.

Glomerulonephritis caused by chronic HBV has been treated with rIFN- α 2b (Lisker-Melmen *et al.*, 1989). In patients in whom aminotransferases fall into the normal range and HBeAg disappears, urine protein excretion also decreases and resolution of the glomerulonephritis occurs (Lin, 1995).

Relative or absolute contraindications to α -interferon therapy include severe depression, Childs B/C cirrhosis, cirrhosis and hypersplenism, autoimmune hepatitis, hyperthyroidism, coronary artery disease, renal transplant, pregnancy, seizures, concomitant drugs, including several herbal remedies, diabetes/hypertension and retinopathy, thrombocytopenia, leucopenia, anaemia, high titres autoantibodies and hyperthyroidism. The side-effects of α -interferon are relatively common, but are acceptable in most patients. Toxicity can be predicted in patients with low baseline white cell counts or thrombocytopenia, or pre-existing thyroid disease (Dusheiko, 1997). The risk of serious complications from α -interferon is rare. However, serious idiosyncratic complications, such as immune disorders, pneumonitis, retinal disease, renal disease or deafness, can occur and the drug always must be prescribed with caution. Close monitoring is required throughout therapy. Monitoring requires regular clinical examinations, vital signs, urinalysis and usually monthly measurement of serum chemistries, complete blood counts and thyroid function tests, including thyroid stimulating hormone. A serum pregnancy test should be done to exclude pregnancy before starting treatment.

Nucleoside analogues. Antiretroviral therapies used in human immunodeficiency virus (HIV) infection have been attempted in chronic HBV infection. Both these viruses utilize a reverse transcriptase, a potential target for antiviral inhibition. However, the usefulness of all the 'first generation' nucleoside analogues in patients is limited (Marcellin *et al.*, 1989; Berk *et al.*, 1992; Fried *et al.*, 1992, Catterall *et al.*, 1992).

Ganciclovir [9-[2-hydroxy-1-hydroxymethyl)-ethoxymethyl]guanine] inhibits HBV DNA replication but needs to be given intravenously. The drug has been used to treat recurrence of hepatitis B

after transplantation, but replication re-ensues when treatment is stopped. Oral ganciclovir has been used to treat HBeAg and anti-HBe-positive hepatitis B in a preliminary trial.

Famciclovir is the oral precursor of penciclovir, a purine nucleoside [9-(4-hydroxy-3-hydroxy-methylbut-1-yl)guanine; BRL 39123]. Penciclovir is poorly absorbed orally, but famciclovir is readily absorbed and rapidly converted into the active molecule penciclovir by enzyme hydrolysis; Phosphorylation leads to the triphosphate compound and interference with synthesis of viral DNA; penciclovir triphosphate reduces varicella zoster and herpes simplex concentrations in cells, and oral famciclovir is an effective treatment of shingles.

The duck model was first used to assess this new agent for hepatitis B. Plasma levels of DHBV DNA were significantly reduced compared to levels in samples collected before treatment (Tsiquaye *et al.*, 1994). Famciclovir has been tested in a phase II trial in 333 HBeAg and HBV DNA patients with chronic hepatitis B, using dosing schedules of 125, 250 and 500 mg three times daily for 16 weeks. The trial has been completed but the results have only been published in abstract form. A significant reduction in HBV DNA and ALT within the treatment period was observed in the 500 mg group, and the HBeAg seroconversion rate was increased over placebo. However, some patients do not appear sensitive to famciclovir, and resistant mutations have been reported.

Lamivudine (2',3'-dideoxy-3'-thiacytidine ((\pm)-SddC), 3TC (Epivir, or lamivudine) is a potent inhibitor of HBV as well as HIV. The drug acts by inhibiting DNA synthesis through chain termination. The ($-$)-form (($-$)-SddC), which is resistant to deoxycytidine deaminase, is the more active antiviral stereoisomer than the ($+$)-form. The negative enantiomer ($-$)-SddC does not appear to affect mitochondrial DNA synthesis. Metabolic studies have shown that the drug is converted to the monophosphate, diphosphate, and triphosphate form. The ($-$)-form is phosphorylated to ($-$)-SddCMP and is subsequently converted to ($-$)-SddCDP and ($-$)-SddCTP (Chang *et al.*, 1992).

The drug is rapidly absorbed after oral administration, with a bioavailability of $> 80\%$. The majority of drug is excreted unchanged in the urine. Since 1990, lamivudine has been used in trials of treatment of HIV infection, and this compound has recently been licensed for combination antiviral

therapy of this disease in the USA. Lamivudine is active *in vitro* against human hepatitis B transfected cell lines and in ducklings affected with DHBV, as well as in chimpanzees infected with HBV.

Large phase II and III trials in patients with chronic hepatitis B are in progress. Doses above 25 mg reproducibly decrease HBV DNA levels in serum. Treatment has been extended to 1 year and more, in dose ranging studies with 5, 20, 100, 300 or 600 mg per day. The results of a several relatively short randomized controlled trials have recently been published. HBV DNA generally became undetectable (by hybridization assay) in more than 90% of patients who received 25–300 mg per day. In most patients, HBV DNA reappears after therapy is completed. Between 15 and 40% of patients treated for a year have sustained suppression of HBV DNA; in an extended retreatment trial, approximately 40% of patients have remained HBeAg negative off therapy; in a large Asian trial, approximately 15% of patients became HBeAg negative after 12 months of treatment, compared to 4% of placebo recipients; treatment has been continued in this and other cohorts. Histological improvement has been noted after 1 year of treatment. Patients with chronic hepatitis B are currently being treated for 1 year with combinations of lamivudine and α -interferon in controlled trials.

In these trials, only minor non-specific adverse events were seen that were not related to dose. Similar results have been observed after 6 months of treatment; a degree of histological improvement has been noted.

The drug appears to be well tolerated, and relatively few serious side-effects have been reported. Serious side-effects have been observed in about 5% of patients; these include anaemia, neutropenia, an increase in liver enzymes, nausea and neuropathy. Increased lipases may occur, but uncommonly, and serious lactic acidosis has not been observed. Severe exacerbations of hepatitis accompanied by jaundice have been reported in patients whose HBV DNA became positive after stopping treatment, or after the development of resistance (Honkoop *et al.*, 1995). We have observed reactivation of hepatitis B in two immunosuppressed liver transplant patients who developed a methionine to valine or isoleucine substitution in the highly conserved tyr-met-asp-asp (YMDD) motif of the HBV polymerase (Ling *et al.*, 1996). This motif is part of the active site of the polymerase, and this mutation parallels the M184

mutation seen in resistant HIV, where substitutions of valine and isoleucine for methionine also have been found.

After lamivudine is stopped, HBV replication may reactivate if viral genomes have not been cleared during treatment. In this case, recurrence of HBV replication can be associated with severe 'flares' or exacerbation of hepatitis as HBV DNA increases in serum. The pathogenesis of this injury is not fully understood. Probably some of the injury is related to an immune response, despite the increasing levels of viraemia. The emergence of resistance could have a similar effect, as viral DNA increases.

Adefovir dipivoxil (bis-POM pMEA) 0-[2-[[bis-[(pivaloyloxy)methyl]phosphinyl]methoxy]ethyl]adenine. This new agent is a phosphonmethylether analogue. It is an oral nucleotide (nucleoside monophosphate) analogue and does not require cellular nucleoside kinases for activation. The drug inhibits viral polymerases and terminates the growing DNA chain by acting as a competitive inhibitor of dATP. Adefovir has an effect on HIV as well as on other retroviruses and also suppresses DHBV and HBV replication.

In experimental studies, adefovir dipivoxil has been shown to inhibit viral DNA synthesis in HBV-transformed hepatoma cell lines and in primary duck hepatocytes from DHBV-positive ducklings. During treatment, viral antigen expression is reduced in bile duct epithelial cells and pancreatic islets. This agent also has some immunomodulatory activity and stimulates natural killer activity.

Dose-dependent toxic effects observed in multiple dose studies in rats and monkeys include nephropathy, characterized by tubular cell necrosis, elevations in hepatic transaminases, elevations in creatinine kinases, and degenerative changes in small and large intestine.

A small pilot study has been concluded, in which 20 patients (13 of whom were coinfecting with HIV) were treated with adefovir dipivoxil 125 mg ($n = 15$) or placebo ($n = 5$) for 28 days. The drug was discontinued in two recipients because of an ALT increase. An ALT increase of more than three times the baseline was observed in four patients on drug or after dosing. A significantly greater decline in HBV DNA was seen in drug recipients compared to placebo. The mean percentage change was -97 compared to -7 in placebo recipients, and all 15 patients

who received active drug had a greater than 90% decline in HBV DNA. Phase II and III studies designed to find the optimal dose and involving larger numbers of patients are now in progress. Preliminary *in vitro* evidence suggests that M552I, and M552V variants of HBV which are relatively resistant to lamivudine are susceptible to inhibition by adefovir.

Phase I and II trials with several new nucleoside analogues are in progress. At this time the long-term efficacy and safety of lamivudine or other new nucleoside analogues are unproven; chronic type B hepatitis disease will require relatively long courses of treatment, often in asymptomatic carriers, perhaps including children, and viral resistance may emerge. The end-points of treatment will require careful evaluation. Combination treatment may become necessary but may not be required for all patients.

Biologic response modifiers. Interleukin 12 is a 75 kDa heterodimeric protein and a member of the TNF receptor superfamily. This cytokine is a product of macrophages and dendritic cells (i.e. antigen presenting cells). Interleukin 12 promotes T_H1 and suppresses T_H2 cell development, suggesting that IL-12 may be useful therapeutically to promote a cellular immune response. The compound induces secretion of γ -interferon from T and natural killer (NK) cells, and increases the lytic activity of NK cells and facilitates specific cytotoxic T lymphocyte (CTL) responses. In experimental murine models of acute viral infections, IL-12 reduces morbidity and prevents reinfection with HSV-2 and cytomegalovirus (CMV). The effect of systemic IL-12 treatment on autoantibody synthesis *in vivo* in HBeAg-expressing transgenic mice has been tested. Low-dose IL-12 significantly inhibited autoantibody (anti-HBe) production by shifting the T_H2 -mediated response towards T_H1 predominance.

Additionally, previous studies suggest that a predominance of HBeAg-specific T_H2 -type cells may contribute to chronicity in HBV infection. Therefore, IL-12 may also prove beneficial in modulating the antibody and cellular immune response in acute hepatitis B to improve clearance of hepatitis B (Milich *et al.*, 1995b). It has been shown that suppression of intrahepatic replication of HBV DNA in transgenic mice is mediated through cytokines such as γ -interferon and TNF. Fever, lethargy, anorexia,

anaemia, thrombocytopenia, stomatitis, pulmonary oedema and increased serum ALT have been observed in experimental animals. Pilot studies have begun in HBV infected patients. IL-12 can also aggravate autoimmune processes, and deaths in patients with renal carcinoma have been observed.

Thymosin is an immune stimulant which is known to enhance suppressor T cell activity and B cell synthesis of IgG *in vitro*. Peptide preparations of thymosin have been evaluated in small controlled trials and HBV DNA has been noted to become negative in some of these patients and in chimpanzees with chronic hepatitis B (Mutchnick *et al.*, 1991). It is given parenterally by subcutaneous injection. This interesting agent's possible therapeutic role was evaluated in a larger controlled trial, in which HBeAg seroconversion rates were not significantly different from recipients given placebo. The place of this drug is still being appraised, as few side effects are observed with thymosin injected subcutaneously.

Immunotherapy

There has been a resurgence of interest in the possibility of immunizing chronically infected, HBV-positive patients to activate an immune response and eradicate viraemia. In a recent pilot study, 32 patients with HBeAg positive, HBV DNA positive chronic hepatitis B were immunized with three standard doses of GenHevac vaccine at monthly intervals. Six months after the first injection, 37% had undetectable DNA. Eight responders were given α interferon to maintain virus inhibition (Pol *et al.*, 1994, Pol, 1995). These results require explanation, as earlier trials of HBsAg vaccination had no demonstrable efficacy for chronic disease. The effects may be the result of altered antigen presentation. Larger controlled trial are in progress.

There is considerable interest in the possibility of provoking a cytotoxic immune response to HBV core epitopes, as the CTL response contributes to viral clearance in acute hepatitis B. A strong cytotoxic T cell response has been observed in HLA A2.1 individuals with acute hepatitis B against an epitope (FLPSDFFPSV) that contains an HLA A2 binding motif located between residues 18–27 of the hepatitis B nucleocapsid protein (Bertoletti *et al.*, 1993). This identification has led to development of a therapeutic vaccine (Theradigm HBV tm) which is now undergoing assessment.

Recently, DNA-based immunization has been tested using purified plasmid DNA containing protein coding sequences and the regulatory elements required for their expression. The DNA is introduced into tissues of the organism by means of a parenteral injection and the number of cells transfected and the amount of protein produced is sufficient to produce a broad-based immune response to a wide variety of foreign proteins. A response to HBsAg has been achieved using this form of antigen presentation. A CD8 + CTL response has been induced in BALB/c mice, suggesting a pathway for exogenous presentation of hepatitis B envelope protein via MHC class I expression (Davis *et al.*, 1995). If the safety of DNA-mediated immunization can be assured, this form of vaccination may also have therapeutic potential (Whalen and Davis, 1995).

Hepatitis B Virus and Primary Liver Cancer

Persistent infection with HBV is associated with a high risk of developing hepatocellular carcinoma (HCC); however, the precise role played by the virus in causing this tumour remains to be elucidated.

Epidemiological Evidence

Hepatocellular carcinoma is one of the 10 most common cancers in the world, with over 250 000 new cases each year. In areas where the tumour is particularly common—for example, some regions of sub-Saharan Africa, China and southeast Asia—the age-adjusted incidence of HCC is over 30 new cases per 100 000 population each year; whereas it is less than 5 cases per 100 000 per year in western Europe and North America. Primary liver cancer is more common in males than among females, and the incidence of the tumour increases with age, reaching a peak in the 30–50 age group.

When specific tests for the serological markers of HBV infection became available, it became clear that the geographical areas with a high incidence of primary liver cancer were coincident with those with a high prevalence of seropositivity for HBsAg. Furthermore, most patients from high risk areas presenting with primary liver cancer proved to be HBsAg positive or to have high titres of anti-HBc. HBV infection in these areas generally occurs at a

young age: in China and southeast Asia the virus usually is acquired perinatally from a carrier mother, while in Africa the infection tends to be acquired in early childhood through horizontal spread of the virus. Thus, there is often a considerable interval between the initial virus infection and development of HCC, although the tumour does occur in younger age groups in high-risk populations.

The relative risk of an HBsAg carrier, compared to a matched non-carrier, developing primary liver cancer was estimated in an elegant prospective study carried out in Taiwan by Beasley and coworkers. Over 22 000 men, including more than 3000 HBsAg carriers, were followed for 75 000 man-years. The HBsAg carriers proved more than 200-fold more likely to develop HCC than members of the non-carrier group and more than 50% of the deaths in the former group were due to the tumour or to cirrhosis, another possible consequence of long-term HBV infection (Beasley and Hwang, 1991).

HBV DNA in Primary Liver Tumours

If HBV does indeed play a causal role in the development of primary liver cancer then the tumours might be expected to contain virus-specific nucleic acid and perhaps also to express viral proteins. The first cell line to be established from a primary liver tumour from an HBsAg carrier (PLC/PRF/5) proved to secrete in culture HBsAg in the form of 22 nm particles with a morphology similar to those found in the plasma of persistently infected individuals. Some other HCC-derived cell lines are HBsAg positive but many are negative. Similarly, immunohistochemistry of HBV-associated tumours shows that a minority produce HBsAg. Production of HBcAg by tumours seems to be rather less common.

Following the molecular cloning of the HBV genome, which made available hybridization probes of high specific activity, the PLC/PRF/5 cell line was shown to contain HBV DNA integrated chromosomally at several sites (Figure 3.13, lane A1). Further analysis reveals considerable rearrangement of the viral DNA, although it is not clear whether these rearrangements were present in the original tumour or occurred during the establishment of the cell line (the genotype of the cultured cells appears to be stable with respect to the integrated HBV sequences). Other cell lines derived from

HBV-associated primary liver tumours have also been shown to contain integrated HBV DNA.

Analysis by DNA:DNA hybridization reveals integrated HBV DNA in approximately 80% of primary liver tumours from HBsAg carriers (Brechot *et al.*, 1980; Chen *et al.*, 1986). An example is illustrated in Figure 3.13, lane D2. It is possible that more sensitive techniques, such as the PCR, may enable the detection of viral DNA sequences in tumours which test negative by hybridization. In most cases, the tumours seem to be clonal with respect to the integrated viral DNA and may have arisen from a single cell. There is, however, considerable variation between tumours in terms of the number of integrants and their location. Although HBV DNA is often found integrated into Alu or other satellite sequences, this is likely to reflect the size of such targets and it seems that the sites of integration in the cellular chromosomes are random.

Nucleic acid sequencing of the junctions between viral and cellular DNA shows that the direct repeats in the virus genome (see the account of the replication of the viral genome above) frequently are located close to these junctions and may be 'hot spots' for recombination with host DNA. Since synthesis of progeny viral DNA in infected cells is cytoplasmic, it is likely that it is an intermediate(s) in the process of conversion of virion DNA, or progeny HBV DNA recycled from the cytoplasm to the nucleus, to covalently closed circular DNA which is involved in the recombination.

Animal Models

Infection of eastern woodchucks (*Marmota monax*) with WHV, which is phylogenetically related to HBV, may progress to chronic hepatitis and primary liver cancer. WHV DNA may be found integrated in the tumours and, in several cases, has been shown to be involved with the rearrangement and altered expression of endogenous *myc* oncogenes, including a pseudogene which is not present in the human genome (Wei *et al.*, 1992). It is not clear what role environmental cocarcinogens may play in the development of primary liver tumours in patients (see below) but, by careful control of diet, it has been possible to demonstrate that WHV infection is sufficient to produce tumours in woodchucks in the absence of dietary cofactors.

Mechanisms of Oncogenesis

Because primary liver cancer most often develops in a liver which is affected by chronic hepatitis or cirrhosis (or both), it has been suggested that the involvement of HBV is mediated through these pathological changes and subsequent regeneration. However, it is clear that HCC is much more likely to develop in an HBV-infected cirrhotic liver than in the cirrhotic liver of an uninfected patient and that tumours often develop in the livers of HBV-infected patients without an intermediate cirrhotic stage. The common finding of integrated viral DNA in tumours implies a more direct role of viral oncogenesis. However, the fact that up to 20% of tumours from HBsAg-carriers may be negative for viral DNA suggests that other mechanisms sometimes may be involved.

Integrated viral DNA also may be detected in the livers of some HBsAg carriers without tumour, both in patients with ongoing virus replication and in those who have cleared replicating virus. The hybridization techniques used are able to detect these integration events only if they occur at the same site in many cells and, since sites of integration in the chromosomes appear to be random, this implies the clonal expansion of a cell with integrated viral DNA. The establishment of such clones in the liver may be the first step in a multistage process leading to carcinoma and there may be a role for other environmental factors (such as mycotoxins in the diet) in such a process. The long interval often seen between the initial virus infection and tumour development fits with this concept. Furthermore, since integration appears to occur repeatedly throughout the period of the virus replication, the continuing accumulation of preneoplastic clones within the liver would increase the probability of progression to tumour in patients with long-term chronic infection.

Production of HBsAg in the livers of carriers who have cleared virus replication, as well as by some tumours, indicates that the surface mRNA may be actively transcribed from integrated viral DNA. The activity of this promoter makes attractive the promoter insertion hypothesis that aberrant transcription of cellular genes may result in loss of growth control. In fact, one such RNA transcript in the PLC/PRF/5 cell line is a hybrid of viral and cellular sequences. However, despite the attractions of this hypothesis, supportive data from analysis of

tumours has not been forthcoming. Expression of the core antigen in tumours appears to be relatively rare, and there are a number of possible explanations for this observation. Firstly, the beginning of the core antigen gene is near to one of the direct repeats which appear to be involved in the integration process, so these sequences may often be disrupted. Secondly, cellular control mechanisms such as DNA methylation may prevent transcription of the core gene. Finally, expression of the core gene may lead to presentation of HBeAg on the cell surface and targeting of the cell for lysis by the immune system. This may effectively select clones with rearrangements of integrated DNA for survival. The tumour cells do not seem to support virus replication (except perhaps in very early tumours) and this may also give a growth advantage in the virus-infected liver.

One mechanism whereby viruses cause neoplastic transformation of cells is via the expression of a transforming gene introduced in the integrated viral genome. The HBV genome does not seem to contain such a gene and it has not been possible to transform cells *in vitro* using virus or viral DNA. The long interval between virus infection and tumour development also argues against such a direct mechanism. Nevertheless, the so-called X gene of HBV has been shown to encode a transcriptional transactivator and the possibility that this protein plays a role in disrupting the normal transcriptional control of the cell cannot be ruled out. Transactivation by the X protein seems to be through responsive elements such as the transcription factor AP-1 (*jun/fos*), AP-2, NF κ B and the CRE site. It has been shown that truncated pre-S proteins also may have transactivating properties. These may be produced in tumour cells by expression of integrated HBV DNA with virus-host junctions in the surface ORF.

A second mechanism of viral oncogenesis is known as insertional mutagenesis. Here, integration of the viral genome results in the introduction of an enhancer sequence or promoter (as discussed above) or may physically disrupt a cellular gene. Although this hypothesis is attractive for HBV, screening of HBV-associated primary liver tumours with a number of oncogenes as probes has not proved fruitful. In one tumour, the HBV genome has been found to be integrated into the gene for a retinoic acid receptor (Dejean *et al.*, 1986) and, in another, a cyclin A gene was involved (Wang *et al.*, 1990). However, these are isolated instances and it

seems that a common mechanism of oncogenesis via insertional mutagenesis is extremely unlikely.

Despite this caveat, the evidence that HBV plays a causative role in tumour development remains convincing. It is possible that further research will uncover more of the mechanisms involved and some of these may have ramifications in the field of human oncology in general. However, many researchers are now focusing on the roles of the X gene product and other transactivators of transcription and of concomitant changes in the gene for p53. Meanwhile, mass vaccination campaigns in many countries are aimed at preventing the spread of the virus to the next generation. Already, there is evidence that the incidence of primary liver cancer in children in Taiwan has fallen markedly (Chang *et al.*, 1997).

HEPATITIS D

Delta hepatitis was first recognized following detection of a novel protein, delta antigen (HDAg), by immunofluorescent staining, in the nuclei of hepatocytes from patients with hepatitis B (Rizzetto *et al.*, 1977). HDV is now known to be defective and require a helper function from HBV for its transmission. HDV is coated with HBsAg, which is needed for release from the host hepatocyte and for entry in the next round of infection. The agent is unique among human viruses and consists of a particle measuring 35–37 nm in diameter, with an internal nucleocapsid comprising the genome surrounded by the delta antigen and enveloped by an outer protein coat of HBsAg. The genome consists of a single-stranded, circular RNA of around 1700 nucleotides, the delta antigen being encoded by antigenomic RNA (reviewed by Taylor, 1997).

Two major modes of delta hepatitis infection are known (Hadziannis, 1997). In the first, a susceptible individual is coinfecting with HBV and HDV, often leading to a more severe form of acute hepatitis caused by HBV. Vaccination against HBV prevents such infections. In the second, an individual chronically infected with HBV becomes superinfected with HDV. This may accelerate the course of the chronic liver disease and cause overt disease in asymptomatic HBsAg carriers. HDV may be cytopathic, and HDAg directly cytotoxic. A less common type of infection has been seen in HDAg-positive pa-

tients who have received liver transplants. Hepatocytes in the graft become infected with HDV circulating at the time of transplantation. In the absence of HBsAg, there is no cell to cell spread of the virus but HDV replication persists in isolated hepatocytes.

Epidemiology

Limited serological studies indicate a worldwide distribution of hepatitis D in association with HBV. The infection is epidemiologically important in Italy, the Middle East (the Gulf States and Saudi Arabia), parts of Africa and South America (Rizzetto, 1996). It has been estimated that 5% of HBsAg carriers worldwide (approximately 15 million people) are infected with HDV. In areas of low prevalence of HBV, those at risk of hepatitis B, particularly intravenous drug users, are also at risk of HDV infection. Epidemics with high mortality have been described in South America in association with severe hepatitis B. Delta infection is associated with acute and chronic hepatitis, always in the presence of hepatitis B, and superinfection in a carrier of HBV often leads to exacerbation of severe hepatitis.

The mode of transmission of hepatitis D is similar to parenteral spread of hepatitis B, so serological evidence of infection is found most frequently in western Europe and North America in multiply transfused individuals, such as patients with haemophilia, and in drug addicts.

Structure and Replication of HDV

The HDV particle is approximately 36 nm in diameter and composed of an RNA genome associated with HDAg, surrounded by an envelope of HBsAg. The virus reaches higher concentrations in the circulation than HBV, up to 10^{12} particles per millilitre have been recorded. The HDV genome is a closed circular RNA molecule of 1679 nucleotides with extensive sequence complementarity that permits pairing of approximately 70% of the bases to form an unbranched rod structure. The genome thus resembles those of the satellite viroids and virusoids of plants and, similarly, seems to be replicated by the host RNA polymerase II with

autocatalytic cleavage and circularization of the progeny genomes via *trans*-esterification reactions (ribozyme activity) (Lai, 1995; Lazinski and Taylor, 1995). Consensus sequences of viroids, which are believed to be involved in these processes, also are conserved in HDV.

Unlike the plant viroids, HDV codes for a protein, HDAg, in an ORF in the antigenomic RNA. Around 600 copies of a polyadenylated mRNA, approximately 800 nt in length, may be detected in the cytoplasm of infected hepatocytes. The antigen, which contains a nuclear localization signal, was originally detected in the nuclei of infected hepatocytes and may be detected in serum only after stripping off the outer envelope of the virion with detergent. The delta antigen is detectable in two forms in the infected hepatocyte. The 195 aa (small) form is required for HDV RNA replication and binds to the rod-like structures of the genome and genome complement. The larger (214 aa) form, which is structural, and therefore required for virion assembly, seems to be synthesized following RNA editing. This process converts the termination codon at the end to the ORF for the short form to a tryptophan codon, resulting in a 19 aa C-terminal extension (Casey and Gerin, 1995).

Laboratory Diagnosis of HDV Infection

Specific serological tests are available to detect antibody to HDV; anti-HD IgM and anti-HD IgG, and for HDV RNA and HDAg. Coinfection and superinfection can be distinguished by correlation of the results of these tests with those for markers of HBV infection. Thus, in coinfection, HBsAg, HBeAg and HBV DNA become detectable in serum along with HDAg and HDV RNA. Coexistence of anti-HBc in IgM with markers of HDV infection is a reliable indication of coinfection; anti-HD IgM becomes detectable, followed by anti-HD IgG. Markers of virus replication usually become undetectable during convalescence.

Superinfection of HBV carriers with HDV results frequently in persistent HDV infection. HD viraemia is followed by an anti-HD IgM, and then IgG, response. Markers of HBV replication may be suppressed during acute HDV infection. Anti-HD IgM persists with HDAg and HDV RNA in serum in chronic delta hepatitis.

Pathogenesis

The pathogenesis of the disease is uncertain. It has long been held that HDV is pathogenic and that the liver injury in hepatitis D is related to HDV itself. These data have recently been challenged with the observation that HDV reoccurs in liver transplanted patients soon after grafting but without signs of HBV recurrence or evidence of liver damage. In these individuals, HDV may establish latent infection that is not dependent upon HBV for replication and which is only associated with recrudescence liver injury after the acquisition of HBV. Hepatitis D virions cannot be released from the infected hepatocytes without an envelope supplied by HBV.

Fulminant hepatitis may occur in acute HDV and HBV infection, and outbreaks of severe hepatitis have been reported in Indians of the Amazon basin and in areas of Central Africa. Degenerative changes were observed in these patients, characterized by fine steatotic vacuolization of hepatocytes, in keeping with a cytotoxic inflammatory lesion.

It is known that hepatitis D may result in interference of HBV replication but the molecular mechanism has not been established. An increase in HDV replication has been noted in concurrent HDV and HIV replication, but this may not necessarily cause more severe hepatitis (Buti *et al.*, 1991). There is also a large body of data to suggest that the pathogenesis of HDV hepatitis is in part immunologically mediated.

Clinical Features

Hepatitis D causes acute, fulminant and chronic hepatitis, either as a coinfection with hepatitis B or as a superinfection in patients with chronic hepatitis B. Clinically there is a spectrum of disease, and in some coinfecting or superinfected persons HDV appears to be a pathogenic agent, and to aggravate the underlying HBV infection. There is much interest in the study of pathogenicity caused by this agent.

Treatment

A number of investigators have evaluated interferon treatment of chronic type D hepatitis. HDV is sensitive to interferon, and doses of 3–10 million IU

three times weekly for 6 months result in repression of hepatitis D and amelioration of biochemical signs of hepatitis, with a decrease in serum aminotransferases (Rizzatto *et al.*, 1986; Saracco *et al.*, 1989; Rosina *et al.*, 1991). Coincident with this decrease, HDV RNA disappears from serum in approximately 50% of cases. Unfortunately many patients relapse when treatment is stopped.

Vaccination

Vaccination against hepatitis B prevents HDV infection. Active immunization with HDV synthetic or expressed gene products may modulate the infection in woodchuck models (Karayiannis *et al.*, 1993).

HEPATITIS C

Hepatitis C Virus is Responsible for Almost All Cases of Parenterally Transmitted Non-A, Non-B Hepatitis

The specific diagnosis of hepatitis types A, B and D revealed a previously unrecognized form of hepatitis which was clearly unrelated to any of these three types. Results obtained from several surveys of post-transfusion hepatitis in the USA and elsewhere provided strong epidemiological evidence of 'guilt by association' of an infection of the liver referred to as non-A, non-B hepatitis (Alter *et al.*, 1988). This was the most common form of hepatitis occurring after blood transfusion in some areas of the world following the introduction of tests for HBsAg. Studies also showed that this infection was common in haemodialysis and other specialized units, that it occurs in a sporadic form in the general population and that it can be transmitted by therapeutic plasma components, and that a prolonged carrier state in the blood may occur. There was also considerable evidence that the parenterally transmitted infection, like hepatitis B, may become persistent and progress to chronic liver disease, cirrhosis and hepatocellular carcinoma.

Transmission studies in chimpanzees helped establish that the main agent of parenterally acquired non-A, non-B hepatitis was likely to be an enveloped virus with a diameter of 30–60 nm (Bradley *et*

al., 1985; He *et al.*, 1987). These studies made available a pool of plasma known to contain a relatively high titre of the agent. In order to clone the genome, the virus was pelleted from the plasma. Because it was not known whether the genome was DNA or RNA, a denaturation step was included prior to the synthesis of complementary DNA so that either DNA or RNA could serve as a template. The resulting cDNA was then inserted into a bacteriophage expression vector and the libraries screened using serum from a patient with chronic non-A, non-B hepatitis.

This approach led to the detection of a clone (designated 5–1–1) which was found to bind to antibodies present in the sera of several individuals infected with non-A, non-B hepatitis (Choo *et al.*, 1989). This clone was used as a probe to detect larger, overlapping clones in the same library. It was possible to demonstrate that these sequences hybridized to a positive-sense RNA molecule of around 10 000 nt which was present in the livers of infected chimpanzees but not in uninfected controls. No homologous sequences could be detected in the chimpanzee or human genomes. By employing a 'walking' technique, it was possible to use newly detected overlapping clones as hybridization probes in turn to select further virus-specific clones from the library. Thus, clones covering the entire viral genome were assembled and the complete nucleotide sequence determined. The organization of the genome (Figure 3.14) closely resembles those of the enveloped RNA viruses, the pestiviruses and flaviviruses, as discussed below.

Organization of the HCV Genome

The genome of HCV (Figure 3.14) resembles those of the pestiviruses and flaviviruses. It comprises around 9400 nt of positive-sense RNA, lacks a 3' poly(A) tract and has a similar gene organization (Choo *et al.*, 1991). It has been proposed that HCV should be designated the prototype of a third genus in the family *Flaviviridae*, *hepacivirus*. All of the viral genomes from this family contain a single large ORF which is translated to yield a polyprotein (of around 3000 amino acids in the case of HCV) from which the viral proteins are derived by post-translational cleavage and other modifications.

There is a short, untranslated region at the 5' end

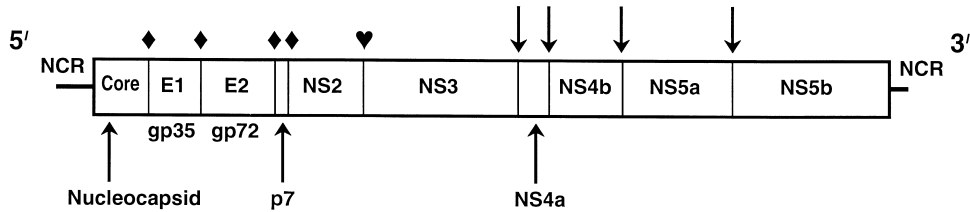

Figure 3.14 Organization of the hepatitis C virus genome. See text for details.

of the genomic RNA and a further untranslated region at the 3' end, the large ORF accounting for over 95% of the sequence. The structural proteins are located towards the 5' end and the non-structural proteins towards the 3' end. The first product of the polyprotein is the non-glycosylated capsid protein, C, which complexes with the genomic RNA to form the nucleocapsid. As with the flaviviruses, a hydrophobic domain may anchor the growing polypeptide in the endoplasmic reticulum and facilitate cleavage by a cellular signalase, releasing a nucleocapsid precursor (anchored C). The amino acid sequence of the nucleocapsid protein seems to be highly conserved among different isolates of HCV.

The next domain in the polyprotein also has a signal sequence at its C-terminus and may be processed in a similar fashion. The product is a glycoprotein, E1 or gp35, which is probably found in the viral envelope. The third domain may be cleaved by a protease within the viral polyprotein to yield a second surface glycoprotein, E2 or gp70. Alternative cleavage sites at the C-terminus of E2 may generate a small addition protein, p7. These glycoproteins have not been visualized *in vivo* and the molecular sizes are estimated from sequence data and expression studies *in vitro*. These envelope proteins are the focus of considerable interest as potential targets in tests for the direct detection of viral proteins and for anti-HCV vaccines.

As with many other RNA viruses, replication of the HCV genome is an error-prone process and the resulting mutations lead to the generation, within an infected individual, of a population of viruses with closely related, but different, nucleotide sequences. This has been termed the 'quasispecies effect'. The effect is particularly noticeable in the region of the genome (the hypervariable region, HVR-1) which encodes a domain at the N-terminus of E2. Sequences within this region are highly variable within each individual, as well as between iso-

lates of the virus, and divergence seems to be driven by the generation of neutralizing antibodies which are targeted to that domain of E2. This hypothesis is supported by the observation that much less variability occurs in agammaglobulinaemic individuals. Thus, efforts to develop hepatitis C vaccines are hampered by variability of the most obvious target molecule and the efficacy of candidate vaccines is likely to be hampered by the rapid evolution of antibody escape mutants.

The non-structural region of the HCV genome is divided into regions NS2 to NS5 (Figure 3.14). In the flaviviruses, NS3 has two functional domains, a protease which is involved in cleavage of the non-structural region of the polyprotein and a helicase which is assumed to be involved in RNA replication. Motifs within this region of the HCV genome have homology to the appropriate consensus sequences, suggesting similar functions. The HCV protease, which uses NS4a as a cofactor, is a major target of efforts to develop specific antiviral agents. Unlike the flaviviruses, HCV encodes a second protease activity: sequences at the NS2–NS3 junction are responsible for self-cleavage of that site. The HCV NS5, unlike that of the flaviviruses, is cleaved to yield NS5a and NS5b. NS5b contains the Gly-Asp-Asp (GDD) motif common to viral RNA-dependent RNA polymerases and so is likely to be the HCV replicase, but NS5a also may be involved in genome replication.

Diagnosis of HCV Infection

Cloning of the HCV genome made possible the development of specific diagnostic tests including enzyme immunoassays (EIAs) for antibody and RT-PCR for viraemia. Since the 5–1–1 antigen originally was detected by antibodies in the serum of an infected patient, it was an obvious candidate for

development of an EIA to detect anti-HCV antibodies. A larger clone, C100, was assembled from a number of overlapping clones and expressed in yeast as a fusion protein using human superoxide dismutase sequences to facilitate expression. This fusion protein formed the basis of first-generation tests for HCV infection (Kuo *et al.*, 1989). It is now known that antibodies to C100 are detected relatively late following an acute infection. Furthermore, the first generation assays were associated with a high rate of false positivity when applied to low incidence populations, and there were further problems with some retrospective studies on stored sera. Data based on this test alone should, therefore, be interpreted with caution.

Second- and later-generation tests include antigens from the nucleocapsid and further non-structural regions of the genome. The former (C22) is particularly useful: the sequence of the HCV core protein is relatively highly conserved, compared to other HCV proteins, and antibodies appear relatively early during infection. Supplementary tests involving several viral antigens bound to a solid substrate, recombinant immunoblot assays (RIBAs), are available and give a more detailed evaluation of the antibody profile of the patient. Antibody tests based on synthetic peptides also are available.

Routine testing of blood donations is now in place in many countries and prevalence rates vary from 0.2–0.5% in northern Europe to 1.2–1.5% in southern Europe and Japan. Many of those who are found to be antibody positive have a history of parenteral risk, such as transfusion or administration of blood products or intravenous drug use. There is minimal evidence for sexual or perinatal transmission of HCV and it is not clear what are the 'natural' routes of transmission.

The availability of the nucleotide sequence of HCV made possible the use of the PCR as a direct test for the (genome of the) virus itself. The first step is the synthesis of a complementary DNA copy of the target region of the RNA genome using reverse transcriptase (RT) primed by the antigenomic PCR primer or random hexadeoxyribonucleotides. The product of this reaction is a suitable target for amplification (RT-PCR). The concentration of virus in serum samples is often very low so that the mass of product from the PCR reaction is insufficient for visualization on a stained gel. Therefore, a second round of amplification (with nested primers) or de-

tection of the primary product by Southern hybridization is required. There is considerable variation in nucleotide sequences among different isolates of HCV and the 5' non-coding region, which seems to be highly conserved, is the preferred target for diagnostic PCR (Garson *et al.*, 1991). Hepatitis C viral load may be estimated by quantitative RT-PCR or using a hybridization assay based on branched oligonucleotides (bDNA assay).

Interpretation of Serological Tests for HCV

A negative EIA test is sufficient to rule out infection in individuals, such as blood donors, without risk factors for HCV infection. For those of low risk, a positive EIA requires confirmation and a supplementary assay for antibodies, such as RIBA, is valuable. Where the RIBA is negative, the EIA result is likely to have been a false positive. If the RIBA is positive, the patient is likely to have (or to have had) hepatitis C. RT-PCR may then be used to determine whether the patient is viraemic. Follow-up RT-PCR also is indicated where the result of the RIBA is indeterminate.

Individuals with even slightly raised serum transaminases should be tested for anti-HCV by EIA and any positive results confirmed by RIBA or assay for HCV RNA. In patients with biochemical or clinical evidence of liver disease, a positive EIA is sufficient to diagnose hepatitis C, and testing for HCV RNA is valuable for confirmation. Quantitative assays for HCV RNA are valuable in monitoring the efficacy of antiviral therapy and may help predict long-term outcome.

Persistence of HCV Infection is Common

Current data suggest that at least 50%, and perhaps more than 80%, of infections with HCV progress to chronicity. Thus, in contrast to HBV infection, where persistent infections of immunocompetent adults are rare, persistent HCV infection seems to be the norm. The morbidity of chronic hepatitis C is affected by many interactive factors, including age of acquisition, concomitant alcohol abuse, gender, coexisting viral disease and the host immune response.

Histological examinations of liver biopsies from

'healthy' HCV carriers (blood donors) reveal that none has normal histology and that up to 70% have chronic active hepatitis and/or cirrhosis (Esteban *et al.*, 1991). It is not clear whether pathological changes result from direct cytopathology of the virus or are mediated by the immune response to infection. HCV infection also is associated with progression to HCC. For example, in Japan, where the incidence of HCC has been increasing despite a decrease in the prevalence of HBsAg, HCV is the major risk factor. There is no DNA intermediate in the replication of the HCV genome or integration of viral nucleic acid, and viral pathology may contribute to oncogenesis through cirrhosis and regeneration of liver cells. HCV infection rarely seems to cause acute liver failure.

Genotypes

The tremendous variation in the sequence of the genomes of various isolates of HCV has led to their classification into types and subtypes (Simmonds *et al.*, 1994) and up to 11 major genotypes are recognized. There is some evidence of variation between genotypes of viral pathogenicity and responsiveness to treatment (see below) but data are incomplete for most genotypes and other variables, such as the age of the patient and the duration of infection, confound interpretation.

Infection with types 1b and 1a are relatively common in Europe; infection with type 1b is frequent in southern Europe. Epidemiological differences in age distribution of major types, and the risk factors associated with particular genotypes, have become apparent. In Europe, types 3a and 1a are relatively more common in young individuals with a history of intravenous drug use. Type 1b accounts for most infections in those aged 50 or more. Type 4 infection is the most prevalent infection in Egypt, and many parts of the Middle East and Africa.

Although an inherently greater pathogenicity of type 1 HCV has been implied, these studies have not always been based on prospective follow-up or appropriately controlled to account for influences of several interdependent parameters and cofactors. Moreover, several clinical investigations have documented severe and progressive liver disease after infection with each of the well-characterized

genotypes (1a, 1b, 2a, 2b, 3a, 4a, 5 and 6), so there is little evidence so far for variants of HCV that are completely non-pathogenic.

Treatment of Hepatitis C

Alpha Interferon

A considerable number of large, controlled therapeutic trials of α -interferon have been undertaken in acute and chronic hepatitis C infection. Treatment is indicated for acute HCV infection because of the propensity of this virus to cause chronic disease; controlled trials indicate that treatment of the acute infection lessens the risk of chronic disease. It is not always clear whether treatment has benefited those patients who might have been convalescing spontaneously. However, if a diagnosis of acute hepatitis C can be made, and the patient does not appear to be convalescing 2–4 months after the onset of the disease, i.e. HCV RNA remains detectable, α -interferon is recommended at a dose of 3–6 million IU thrice weekly for 12 months, or α -interferon and ribavirin for 6 months.

Chronic Hepatitis C

There is evidence that alcohol and hepatitis C may act synergistically in causing hepatic injury, and the drinking of excess alcohol is discouraged because of this evidence (Miyakawa *et al.*, 1993; Sawada *et al.*, 1993). The patient should be advised not to donate blood. Patients can be told that the parenteral route is the most important route of transmission and that the virus is not easily transmitted except by this route.

Alpha interferon is indicated for the treatment of patients with chronic hepatitis C infection who are HCV RNA positive and have elevated serum aminotransferases with histologically moderate chronic hepatitis or more advanced lesions (Anonymous, 1997; Hoofnagle and Tralka, 1997). Thus a liver biopsy generally is required. There is currently no substitute for liver biopsy to ascertain the grade (severity and extent of hepatic inflammation) or stage the disease (fibrosis).

Serum aminotransferases, bilirubin, alkaline phosphatase and prothrombin time should be measured. In patients whose lifestyle or geographic origin suggest that they are at risk of other viral

infections, HBsAg and HIV infection need also be considered. It is not easy to chart the prognosis for patients seen at one point in time, however, as the disease progresses at variable rates in individual patients. Treating relatively mild, early disease in younger patients to prevent cirrhosis is a rational objective.

Four α -interferons have been studied in large controlled trials of α -interferon. Several, including HuIFN- α -N1 (Wellferon), rIFN- α -2b (Intron A) and rIFN- α -2a (Roferon-A) and consensus interferon have been evaluated for the treatment of chronic hepatitis C. In the large placebo-controlled studies approximately 50% of patients with chronic hepatitis C have an initial response to 3 million IU three times a week (Davis *et al.*, 1989; Di Bisceglie *et al.*, 1989). Serum ALT concentrations generally are used to assess response, and if these have not become normal in 3 months, then treatment is stopped, as most responsive patients will respond within this period. However, after stopping treatment after 6 months, approximately one half of the responsive patients will relapse. Between 15 and 25% of patients have sustained virological responses and become HCV RNA negative. Responsive patients usually show histological improvement. It is reasonable to infer that those patients who, a year after stopping interferon treatment, have normal serum ALT and are negative for HCV RNA by sensitive PCR, have responded to therapy, but long term studies to ascertain the effect on survival have not been done. The majority of patients who relapse do so within 6 months of stopping treatment. Serum aminotransferases usually increase in patients who are HCV RNA positive at the end of therapy, although in some cases the relapse may be delayed for several months (Chayama *et al.*, 1991). Prolonging therapy for 1 year to 18 months is now recommended. Higher (induction) doses may be beneficial, but are associated with a greater incidence of side-effects (Kakumu *et al.*, 1990).

Unfortunately, responsiveness to α -interferon remains somewhat unpredictable. Factors which predict a greater likelihood of response are now being studied. Multivariate analyses of several pretreatment parameters indicate that patients without cirrhosis, with genotype 2 and 3 infection and with lower levels of viraemia are more likely to respond (to 6 months treatment) than patients with genotype 1 (and perhaps type 4) infection. Immunosuppressed patients and patients with HIV may re-

spond, although long-term responsiveness is uncertain. This is of particular importance in liver transplant patients.

Within genotypes, response rates may be higher for patients with lower virus concentrations and less advanced disease. Younger patients and patients without fibrosis or cirrhosis are also more responsive to therapy (Chemello *et al.*, 1995). The mechanisms by which different genotypes might differ in responsiveness to treatment remain obscure. Patients with diverse circulating quasispecies may be less responsive to therapy than those with a single major species. Unfortunately, the issue remains complex: there is not yet a standardized system or nomenclature for quantitating concentrations of HCV RNA in serum. Also, these factors may be interdependent.

Patients with normal ALT prior to treatment may develop an exacerbation after failed interferon therapy. The mechanism is unknown but could be a result of displacement of interferon sensitive clones. Recent molecular evidence indicates that an interferon sensitive region can be defined in the NS5a region in patients with genotype 1b infection. Patients with more amino acid substitutions in the NS5A gene (region 2209–2248) were more likely to have a complete response than patients with wild type 1b (Enomoto *et al.*, 1996).

Because autoimmune hepatitis is treated differently, and may be aggravated by interferon therapy, it is particularly advisable to exclude this diagnosis by measuring the titres of anti-smooth muscle and anti-liver kidney microsomal antibodies, even in those with a positive anti-HCV test, and to measure HCV RNA in anti-HCV-positive patients in whom α -interferon is contemplated.

Ribavirin

Ribavirin is a synthetic guanosine nucleoside analogue, which possesses a broad spectrum of activity against both DNA and RNA viruses *in vitro* and *in vivo* (Fernandez *et al.*, 1986). Efficacy has been demonstrated in several viral diseases. The drug exerts its action after intracellular phosphorylation to mono-, di- and triphosphate nucleotides. The precise mode of action probably includes perturbation of intracellular nucleoside triphosphate pools, interference with the formation of the 5' cap structure of viral mRNA by competitive inhibition of both guanyltransferase and methyltransferase capping

enzymes (although this may not be relevant for HCV), direct inhibition of the viral RNA–polymerase complex and, possibly, enhancement of macrophage inhibition of viral replication.

The major side-effects of the drug that have been reported include anaemia, a metallic taste, dry mouth, flatulence, dyspepsia, nausea, headaches, irritability, emotional lability, fatigue, insomnia, skin rashes and myalgia. Mild reversible anaemia is common. Modest increases in uric acid have been reported. Ribovirin is also teratogenic and contra-indicated in pregnancy, patients should not conceive for at least 6 months after stopping therapy.

Studies of Ribavirin in Hepatitis C Infection

Small pilot studies indicated that ALT and aspartate aminotransferase (AST) declined in patients treated with ribavirin, but both returned to pretreatment levels when treatment was stopped. In an open label study in Sweden, in which ribavirin was prescribed to 10 patients with chronic hepatitis C (1000–1200 mg per day) for 12 weeks, the median serum AST levels declined but rose to pretreatment levels upon completion. A small study, using escalating doses of ribavirin (600–1200 mg) showed a somewhat slower fall in serum aminotransferases, perhaps reflecting the lower starting dose of ribavirin (Di Bisceglie *et al.*, 1992). There was a significant decrease in geometric mean titres of HCV RNA. Several placebo-controlled trials have indicated that, despite the significant improvement in serum ALT, a marked decline in serum HCV concentrations does not occur. Most patients relapse when therapy is stopped (Dusheiko *et al.*, 1996; Bodenheimer *et al.*, 1997).

Interferon Treatment of Cirrhosis

Alpha interferon treatment should be targeted to patients before the development of cirrhosis, as patients are at risk of developing sequelae once cirrhosis has developed. Several small trials have suggested that interferon therapy improves liver function and reduces the incidence of HCC in patients with cirrhosis due to hepatitis B or C (Nishiguchi *et al.*, 1995). A recent, retrospective analysis of data for 913 patients with chronic viral hepatitis and cirrhosis from Italy and Argentina showed that interferon treatment lowered the rate of progression to hepatocellular carcinoma twofold (International Inter-

feron- Hepatocellular Carcinoma Study Group, 1998). The risk reduction was apparently greater for patients with chronic hepatitis C and no evidence of infection with HBV.

Ribavirin and Interferon

Two large studies have been undertaken to assess the effect of ribavirin and α -interferon combined, versus α -interferon alone, in naive and relapsed patients. Current trials indicate that approximately 45–50% of patients who have relapsed after α -interferon have sustained biochemical and virological responses to combined therapy. The mechanism of apparent synergism is not yet understood (Lai *et al.*, 1996; Schalm *et al.*, 1996, 1997; Bizollon *et al.*, 1997; Lindsay 1997; Reichard *et al.*, 1997). Approximately 35% of naive patients respond to a combination of ribavirin and α -interferon.

Prevention of Hepatitis C

There are no vaccines available to protect contacts of patients with hepatitis C. However, secondary transmission should be relatively easy to prevent. The role of intrafamilial transmission requires clarification, but is relatively infrequent. Sexual transmission is possible and has been described, but this fortunately is a relatively inefficient and infrequent route. Young sexually active adults could be told of the advisability of condom use in general for casual sexual contact.

Mother-to-infant transmission has been observed, but appears to be unusual. Differences in the rate of maternal–infant transmission in different countries remain unexplained, and the importance of this route in perpetuating the reservoir of human infection is unknown, but could be relevant. Maternal–infant transmission is more likely in mothers with HCV RNA concentrations higher than 10^7 genomes per millilitre. Transmission from infected surgeons to their patients has now been documented and verified by molecular epidemiological evidence (Esteban *et al.*, 1996). It is unknown whether higher levels of viraemia and particular forms of surgery are more likely to transmit infection.

GB AND 'HEPATITIS G' VIRUSES

The discovery of HCV and HEV and their roles in causing parenterally transmitted, epidemic and sporadic cases of non-A, non-B hepatitis does not rule out the possibility that there are other, unidentified human viruses which may cause hepatitis. Incubation times varied following transmission of non-A, non-B hepatitis to non-human primates, suggesting the involvement of more than one agent. The results of subsequent cross-challenge experiments seemed to support this conclusion, although retrospective analyses of some of these studies implicate reinfection with HCV. Some sporadic cases of acute liver failure may be associated with a virus infection, candidate hepatitis F (fulminant) virus. Virus-like particles were detected by electron microscopy (Fagan *et al.*, 1992) but, although other viruses were excluded rigorously (Fagan and Harrison, 1994), a viral aetiology has not been confirmed by experimental transmission to susceptible animals. Other viruses may exist which are spread by the faecal-oral route and have a tropism for the liver.

Viruses which cause acute and persistent infections of the liver may be difficult to detect, particularly if those infections are asymptomatic in most individuals. A candidate recently has been described by two groups working independently and given the provisional names GB virus C (GBV-C) (Simons *et al.*, 1995a) and hepatitis G virus (HGV) (Linnen *et al.*, 1996). Formal classification awaits the decision of the International Committee on the Taxonomy of Viruses.

GB agents

Hepatitis viruses are notoriously difficult to grow in cell culture, and experimental transmission to animals, especially primates, has played an essential role in their discovery. In 1967, Deinhardt described attempts to transmit to monkeys viral hepatitis from a number of human sources (Deinhardt *et al.*, 1967). Administration of acute phase plasma from a surgeon (with the initials GB), who suffered from hepatitis with 4 weeks of icterus, gave rise to abnormal liver function tests in all of four tamarins tested. In more recent experiments, infection was transmitted to *Saguinus labiatus* from stored sera, and at-

tempts were made to clone the genome of the putative viral agent using immunoscreening (λ gt11 expression libraries) and representational difference analysis (RDA). The genomes of two distinct, but related, viruses were present in the cloning source and these viruses have been provisionally designated GB viruses A and B (GBV-A and GBV-B) (Simons *et al.*, 1995b). The genomes are of a size (around 9.5 kb) and organizational strategy typical of the *Flaviviridae* and, more specifically, resemble those of the pestiviruses and HCV.

Given the passage history of the cloning source, it seems possible that one, or both, of these viruses originated from the experimental animal(s); GBV-A seems to be a representative of a number of closely related viruses found in New World monkeys. The question of whether GBV-B is the virus which caused hepatitis in the surgeon, or is a second monkey virus, remains unanswered; further isolates of this virus have not been discovered in humans or other animals.

Discovery of GBV-C and HGV

Cross-reactive antibodies were detected in around 1.5% in volunteer blood donors from the USA, 14.0% of intravenous drug users and 19.9% of individuals from West Africa, using enzyme immunoassays based on recombinant GBV-A and GBV-B proteins. The presence of highly conserved motifs in the non-structural helicase region (NS3) allowed the development of a PCR assay with degenerate primers which enabled amplification of GBV-A, GBV-B and HCV. The PCR product from one of the antibody-positive, West African sera led to cloning and sequencing of a further novel virus, GBV-C. Working independently, another research group cloned viral cDNA from the sera of a patient with chronic post-transfusion hepatitis and of a phlebotomist with intermittent rises in ALT levels, and named this virus hepatitis G virus (HGV, Linnen *et al.*, 1996). Sequence comparisons of GBV-C and HGV confirm 85% identity at the nucleotide, and 95% at the amino acid, level and that they are separate isolates of the same virus.

Biology of the GB Viruses and HGV

The structure of the genomes of all of these new

viruses is typical of the *Flaviviridae* and, more specifically, is similar to HCV. The genomes are positive-sense, single-stranded RNA molecules with short, untranslated regions at either end. They encode single, large polyproteins organized with the structural polypeptides at the N-terminal end and with conserved motifs in the non-structural region which include a serine protease (NS3), RNA helicase (NS3) and an RNA-dependent RNA polymerase (NS5). All three novel viruses seem to encode two putative envelope glycoproteins, E1 and E2, as is the case for HCV. However, while the nucleocapsid polypeptide of GBV-B (156 amino acids) seems roughly equivalent to that of HCV (191 amino acids), clearly discernible nucleocapsid proteins cannot be identified in the genomes of GBV-A and GBV-C/HGV. In up to 25% of isolates of the human virus, the first available AUG codon for initiation of translation of the long ORF is at the beginning of the envelope glycoprotein region. It is questionable whether viruses without a nucleocapsid protein are viable and one may speculate that defective viruses, with deletions towards the 5' end, are generated during infection. Translation of the ORFs of GBV-A and GBV-C/HGV involves an internal ribosome entry site (IRES) in the 5' untranslated region of the genome, as is the case for HCV. Sequence variation among isolates of GBV-C/HGV, including in the region encoding the surface glycoproteins, seems to be rather less than for HCV. More diverse variants of this virus may await discovery. Meanwhile, application of the term 'genotypes' to isolates of GBV-C/HGV describes a level of genetic diversity roughly equivalent to subtypes (variation within a genotype) of HCV.

Clinical Significance of GBV-C/HGV Infection

Despite much effort, it has not been possible to identify recombinant antigens which react consistently in immunoassays with antibodies in the sera of infected individuals. Detection of the genome by RT-PCR remains the sole reliable method for diagnosing viraemia. Estimates of the prevalence of GBV-C/HGV infection in healthy individuals varies from 0.8% (blood donors with normal ALT levels in the USA) to 5.7% (Vietnam) and are much higher for those with parenteral risk factors, such as

the multiply transfused and HCV-positive individuals. Antibodies to the envelope (E2) glycoprotein seem to be a marker of recovery from past infection but their longevity remains to be established. GBV-C/HGV viraemia has been detected in patients with a variety of disorders, including chronic liver disease and acute liver failure, but a causative role remains unproven. Many individuals who have been found to be infected are symptomless, or have only mild elevations of serum transaminases as the sole evidence of liver involvement. Indeed, definitive evidence that this virus infects the liver is lacking and the site(s) of replication remains to be determined.

Whether GBV-C/HGV causes significant disease in a minority of those infected remains to be established. Clearly, the virus may cause persistent infections but it is not known whether some acute infections are cleared over a relatively short time frame. Preliminary studies suggest that individuals who have cleared an infection with GBV-C/HGV may outnumber those persistently infected severalfold but chronic infections persisting for several years have been documented and the average duration of such chronic infections is unknown. GBV-C/HGV may share a common pattern of transmission with HCV. Infection is common in risk groups, such as intravenous drug users and the recipients of blood products, including haemophiliacs and patients with combined variable immunodeficiency. Instances of transmission through transfusion have been documented. Given their common mode of transmission, it is not surprising that coinfections may occur with HCV and GBV-C/HGV.

Two recent articles question further the role of GBV-C/HGV in the aetiology of liver disease. Among 79 patients with post-transfusion hepatitis, only three were infected with GBV-C/HGV alone—they had only mild hepatitis, and serum levels of ALT and GBV-C/HGV RNA were poorly correlated (Alter *et al.*, 1997b). Furthermore, there was no evidence that coinfection with GBV-C/HGV worsened the outcome of HCV infection. The other study included an investigation of 45 patients with a diagnosis of non-A–E hepatitis (Alter *et al.*, 1997a). Although four were positive for GBV-C/HGV RNA, the authors concluded that there was no evidence to implicate the virus as an aetiological agent of non-A–E hepatitis, nor was there evidence that persistent infection with GBV-C/HGV leads to chronic liver disease. Detection of GBV-C/HGV in

the absence of other known viruses does not rule out possible coinfection with yet undiscovered, parenterally transmitted viruses. Calls for the routine screening of donated blood for GBV-C/HGV are inevitable, but this will be difficult to implement pending the availability of immunoassays which may be relied upon to detect viral antigens or antibodies in persistently infected individuals. The prospect of universal screening through RT-PCR is daunting, but testing may be possible in special circumstances, such as for graft recipients. However, in the absence of a clear association with a specific disease, this new human virus presently remains something of an orphan.

A NOVEL HUMAN VIRUS, TTV

Novel viral sequences recently were isolated in Japan from a patient with post-transfusion hepatitis not associated with any of the conventional hepatitis viruses described above (Nishizawa *et al.*, 1997). The virus in question seems to have a single stranded DNA genome of around 3850 bases and may be related to the circoviruses (Mushahwar *et al.*, 1999). There is evidence of a degree of sequence variability, which is remarkable for a DNA virus, and it has been suggested that at least two genotypes are distributed worldwide (Naoumov *et al.*, 1998; Simmonds *et al.*, 1998). It should be noted that TT virus is named after the initials of the patient from whom it was isolated (Nishizawa *et al.*, 1997) and TT is not an acronym for 'transfusion transmitted'.

TTV may be detected, using sensitive PCR, in around 10% of normal blood donors in Japan (Okamoto *et al.*, 1998) and around 2% of unpaid blood donors and 10% of 'normal' controls in the UK (Naoumov *et al.*, 1998; Simmonds *et al.*, 1998). Such a high prevalence of infection is certain to lead to transmission by transfusion, in the absence of screening, but it is also evident that transfusion cannot be the major route of transmission. Thus, the designation 'transfusion transmitted virus' is inappropriate. Furthermore, although the virus has been detected in a number of patients with hepatitis, including fulminant hepatitis, proof of a causal association requires rigorous testing of panels of sera, including samples taken prior to the onset of hepatitis. Initial studies have failed to find evidence of

such an association (Naoumov *et al.*, 1998; Simmonds *et al.*, 1998).

REFERENCES

- Alter, H.J. (1988) Transfusion-associated non-A, non-B hepatitis. The first decade. In *Viral Hepatitis and Liver Disease* (ed. A.J. Zuckerman, pp 537–542. Liss, New York).
- Alter, M.J., Gallagher, M., Morris, T.T. *et al.* (1997a) Acute non-A-E hepatitis in the United States and the role of hepatitis G virus infection. *New England Journal of Medicine*, **336**, 741–746.
- Alter, H.J., Nakatsuji, S., Melpolder, J. *et al.* (1997b) The incidence of transfusion-associated hepatitis G virus infection and its relation to liver disease. *New England Journal of Medicine*, **336**, 747–754.
- Anonymous (1997) Management of hepatitis C. *NIH Consensus Statement*, **15**(3), 1–41.
- Beasley, R.P. and Hwang, L.-Y. (1991) Overview on the epidemiology of hepatocellular carcinoma. In *Viral Hepatitis and Liver Disease* (eds F.B. Hollinger, S.M. Lemon and H.S. Margolis), pp 532–535. Williams and Wilkins, Baltimore.
- Berk, L., Schalm, S.W. and Heijntink, R.A. (1992) Zidovudine inhibits hepatitis B virus replication. *Antiviral Research*, **19**, 111–118.
- Bertoletti, A., Chisari, F.V., Penna, A. *et al.* (1993) Definition of a minimal optimal cytotoxic T-cell epitope within the hepatitis B virus nucleocapsid protein. *Journal of Virology*, **67**, 2376–2380.
- Bertoletti, A., Costanzo, A., Chisari, F.V. *et al.* (1994) Cytotoxic T lymphocyte response to a wild type hepatitis B virus epitope in patients chronically infected by variant viruses carrying substitutions within the epitope. *Journal of Experimental Medicine*, **180**, 933–943.
- Bizollon, T., Palazzo, U., Ducerf, C. *et al.* (1997) Pilot study of the combination of interferon alfa and ribavirin as therapy of recurrent hepatitis C after liver transplantation. *Hepatology*, **26**, 500–504.
- Blumberg, B.S., Alter, H.J. and Visnich, S. (1965) A 'new' antigen in leukemia sera. *JAMA*, **191**, 541–546.
- Bodenheimer, H.C., Jr, Lindsay, K.L., Davis, G.L. *et al.* (1997) Tolerance and efficacy of oral ribavirin treatment of chronic hepatitis C: a multicenter trial. *Hepatology*, **26**, 473–477.
- Bradley, D.W. (1992) Hepatitis E: epidemiology, aetiology and molecular biology. *Reviews in Medical Virology*, **2**, 19–28.
- Bradley, D.W., McCaustland, K.A., Cook, E.H. *et al.* (1985) Posttransfusion non-A, non-B hepatitis in chimpanzees. Physicochemical evidence that the tubule-forming agent is a small, enveloped virus. *Gastroenterology*, **88**, 773–779.
- Bradley, D.W., Krawczynski, K., Cook, E.H. Jr *et al.* (1988) Enterically transmitted non-A, non-B hepatitis: etiology of disease and laboratory studies in non-human primates. In *Viral Hepatitis and Liver Disease* (ed. A.J. Zuckerman), pp 138–147. Liss, New York.
- Brecht, C., Pourcel, C., Louise, A. *et al.* (1980) Presence of integrated hepatitis B virus DNA sequences in cellular DNA of human hepatocellular carcinoma. *Nature*, **286**, 533–535.
- Brunetto, M.R., Oliveri, F., Rocca, G. *et al.* (1989) Natural course and response to interferon of chronic hepatitis B accompanied

- by antibody to hepatitis B e antigen. *Hepatology*, **10**, 198–202.
- Buti, M., Esteban, R., Español, M.T. *et al.* (1991) Influence of human immunodeficiency virus infection on cell-mediated immunity in chronic D hepatitis. *Journal of Infectious Diseases*, **163**, 1351–1353.
- Byrom, N.A., Davidson, G., Draper, C.C. *et al.* (1973) Role of mosquitoes in transmission of hepatitis B. *Journal of Infectious Diseases*, **128**, 259–260.
- Carman, W.F., Jacyna, M.R., Hadziyannis, S. *et al.* (1989) Mutation preventing formation of hepatitis B e antigen in patients with chronic hepatitis B infection. *Lancet*, **ii**, 588–591.
- Carman, W.F., Zanetti, A.R., Karayiannis, P. (1990) Vaccine-induced escape mutant of hepatitis B virus. *Lancet*, **336**, 325–329.
- Carman, W.F., Fagan, E.A., Hadziyannis, S. *et al.* (1991) Association of a precore genomic variant of hepatitis B virus with fulminant hepatitis. *Hepatology*, **14**, 219–222.
- Casey, J.L. and Gerin, J.L. (1995) Hepatitis D virus RNA editing: specific modification of adenosine in the antigenomic RNA. *Journal of Virology*, **69**, 7593–7600.
- Catterall, A.P., Moyle, G.J., Hopes, E.A. *et al.* (1992) Dideoxyinosine for chronic hepatitis B infection. *Journal of Medical Virology*, **37**, 307–309.
- Cavanaugh, V.J., Guidotti, L.G. and Chisari, F.V. (1997) Interleukin-12 inhibits hepatitis B virus replication in transgenic mice. *Journal of Virology*, **71**, 3236–3243.
- Chang, C.-N., Doong, S.-L., Zhou, J.H. *et al.* (1992) Deoxycytidine deaminase-resistant stereoisomer is the active form of (±)-2',3'-dideoxy-3'-thiacytidine in the inhibition of hepatitis B virus replication. *Journal of Biological Chemistry*, **267**, 13938–13942.
- Chang, M.H., Chen, C.J., Lai, M.S. *et al.* (1997) Universal hepatitis B vaccination in Taiwan and the incidence of hepatocellular carcinoma in children. *New England Journal of Medicine*, **336**, 1855–1859.
- Chayama, K., Saitoh, S., Arase, Y. *et al.* (1991) Effect of interferon administration on serum hepatitis C virus RNA in patients with chronic hepatitis C. *Hepatology*, **13**, 1040–1043.
- Chemello, L., Bonetti, P., Cavalletto, L. *et al.* (1995) Randomized trial comparing three different regimens of alpha-2a-interferon in chronic hepatitis C. *Hepatology*, **22**, 700–706.
- Chen, J.-Y., Harrison, T.J., Lee, C.-S. *et al.* (1986) Detection of hepatitis B virus DNA in hepatocellular carcinoma. *British Journal of Experimental Pathology*, **67**, 279–288.
- Choo, Q.L., Kuo, G., Weiner, A.J. *et al.* (1989) Isolation of a cDNA clone derived from a blood-borne non-A, non-B viral hepatitis genome. *Science*, **244**, 359–362.
- Choo, Q.L., Richman, K.H., Han, J.H. *et al.* (1991) Genetic organization and diversity of the hepatitis-C virus. *Proceedings of the National Academy of Sciences of the USA*, **88**, 2451–2455.
- Cohen, J.I., Ticehurst, J.R., Purcell, R.H. *et al.* (1987) Complete nucleotide sequence of wild-type hepatitis A virus: comparison with different strains of hepatitis A virus and other picornaviruses. *Journal of Virology*, **61**, 5–59.
- Cupps, T.R., Hoofnagle, J.H., Ellis, R.W. *et al.* (1990) *In vitro* immune responses to hepatitis B surface antigens S and preS2 during acute infection by hepatitis B virus in humans. *Journal of Infectious Diseases*, **161**, 412–419.
- Davis, G.L., Balart, L.A., Schiff, E.R. *et al.* (1989) Treatment of chronic hepatitis C with recombinant interferon alfa. A multicenter randomized, controlled trial. *New England Journal of Medicine*, **321**, 1501–1506.
- Davis, H.L., Schirmbeck, R., Reimann, J. *et al.* (1995) DNA-mediated immunization in mice induces a potent MHC class I-restricted cytotoxic T lymphocyte response to the hepatitis B envelope protein. *Human Gene Therapy*, **6**, 1447–1456.
- Dawson, G.J., Chau, K.H., Cabal, C.M., *et al.* (1992) Solid-phase enzyme-linked immunosorbent assay for hepatitis-E virus IgG and IgM antibodies utilizing recombinant antigens and synthetic peptides. *Journal of Virological Methods*, **38**, 175–186.
- Deinhardt, F., Holmes, A.W., Capps, R.B. *et al.* (1967) Studies on the transmission of human viral hepatitis to marmoset monkeys. I. Transmission of disease, serial passages, and description of liver lesions. *Journal of Experimental Medicine*, **125**, 673–688.
- Dejean, A., Bouguelset, L., Grzeschik, K.-H. *et al.* (1986) Hepatitis B virus DNA integration in a sequence homologous to v-erb-A and steroid receptor genes in a hepatocellular carcinoma. *Nature*, **322**, 70–72.
- Di Bisceglie, A.M., Martin, P., Kassianides, C., *et al.* (1989) Recombinant interferon alfa therapy for chronic hepatitis C. A randomized, double-blind, placebo-controlled trial. *New England Journal of Medicine* **321**, 1506–1510.
- Di Bisceglie, A.M., Shindo, M., Fong, T.-L. *et al.* (1992) A pilot study of ribavirin therapy for chronic hepatitis C. *Hepatology*, **16**, 649–654.
- Dusheiko, G. (1997) Side effects of alpha interferon in chronic hepatitis C. *Hepatology*, **26**, 112S–121S.
- Dusheiko, G., Dibisceglie, A., Bowyer, S. *et al.* (1985) Recombinant leukocyte interferon treatment of chronic hepatitis B. *Hepatology*, **5**, 556–560.
- Dusheiko, G., Main, J., Thomas, H. *et al.* (1996) Ribavirin treatment for patients with chronic hepatitis C: results of a placebo-controlled study. *Journal of Hepatology*, **25**, 591–598.
- Ellerbeck, E.F., Lewis, J.A., Nalin, D. *et al.* (1992) Safety profile and immunogenicity of an inactivated vaccine derived from an attenuated strain of hepatitis A. *Vaccine*, **10**, 668–672.
- Emerson, S.U., Huang, Y.K., McRill, C. *et al.* (1992) Mutations in both the 2B-gene and 2C-gene of hepatitis A virus are involved in adaptation to growth in cell culture. *Journal of Virology*, **66**, 650–654.
- Enomoto, N., Sakuma, K., Asahina, Y. *et al.* (1996) Mutations in the non-structural protein 5a gene and response to interferon in patients with chronic hepatitis B 1b infection. *New England Journal of Medicine*, **334**, 77–81.
- Esteban, J.I., Lopezalavera, J.C., Genesca, J. *et al.* (1991) High rate of infectivity and liver disease in blood donors with antibodies to hepatitis-C virus. *Annals of Internal Medicine*, **115**, 443–449.
- Esteban, J.I., Gomez, J., Martell, M. *et al.* (1996) Transmission of hepatitis C virus by a cardiac surgeon. *New England Journal of Medicine*, **334**, 555–560.
- Fagan, E.A. and Harrison, T.J. (1994) Exclusion in liver by polymerase chain reaction of hepatitis B and C viruses in acute liver failure attributed to sporadic non-A, non-B hepatitis. *Journal of Hepatology*, **21**, 587–591.
- Fagan, E.A., Ellis, D.S., Tovey, G.M. *et al.* (1992) Toga virus-like particles in acute liver failure attributed to sporadic non-A, non-B hepatitis and recurrence after liver transplantation. *Journal of Medical Virology*, **38**, 71–77.
- Fattovich, G., Giustina, G., Degos, F. *et al.* (1997) Morbidity and

- mortality in compensated cirrhosis type C: a retrospective follow-up study of 384 patients. *Gastroenterology*, **112**, 463–472.
- Fernandez, H., Banks, G. and Smith, R. (1986) Ribavirin: a clinical overview. *European Journal of Epidemiology*, **2**, 1–14.
- Flehmg, B., Heinricy, U. and Pfisterer, M. (1989) Immunogenicity of a killed hepatitis A vaccine in seronegative volunteers. *Lancet*, **i**, 1039–1041.
- Fried, M.W., Korenman, J.C., Di Bisceglie, A.M. *et al.* (1992) A pilot study of 2',3'-dideoxyinosine for the treatment of chronic hepatitis B. *Hepatology*, **16**, 861–864.
- Garson, J.A., Ring, C.J.A. and Tuke, P.W. (1991) Improvement of HCV genome detection with 'short' PCR products. *Lancet*, **338**, 1466–1467.
- Gust, I.D., Coulepis, A.G., Feinstone, S.M. *et al.* (1983) Taxonomic classification of hepatitis A. *Intervirology*, **20**, 1–7.
- Hadziyannis, S.J. (1997) Hepatitis delta—Review. *Journal of Gastroenterology and Hepatology*, **12**, 289–298.
- Hadziyannis, S.J., Lieberman, H.M., Karvountzis, G.G. *et al.* (1983) Analysis of liver disease, nuclear HBcAg, viral replication, and hepatitis B virus DNA in liver and serum of HBeAg Vs.anti-HBe positive carriers of hepatitis B virus. *Hepatology*, **3**, 656–662.
- Halliday, M.L., Kang, L.-Y., Zhou, T.-K. *et al.* (1991) An epidemic of hepatitis A attributable to the ingestion of raw clams in Shanghai, China. *Journal of Infectious Diseases*, **164**, 852–859.
- Harrison, T.J., Anderson, M.G., Murray-Lyon, I.M. *et al.* (1986) Hepatitis B virus DNA in the hepatocyte. A series of 160 biopsies. *Journal of Hepatology*, **2**, 1–10.
- Harrison, T.J., Hopes, E.A., Oon, C.J. *et al.* (1991) Independent emergence of a vaccine-induced escape mutant of hepatitis B virus. *Journal of Hepatology*, **13**(suppl. 4), S105–S107.
- He, L.F., Alling, D., Popkin, T. *et al.* (1987) Determining the size of non-A, non-B hepatitis virus by filtration. *Journal of Infectious Diseases*, **156**, 636–640.
- Honkoop, P., De Man, R.A., Heijntink, R.A. *et al.* (1995) Hepatitis B reactivation after lamivudine. *Lancet*, **346**, 1156–1157.
- Hoofnagle, J.H. and Tralka, T.S. (1997) The National Institutes of Health consensus development conference: Management of hepatitis C—Introduction. *Hepatology*, **26**, 1S; and The National Institutes of Health consensus development conference panel statement: Management of hepatitis C. *Hepatology*, **26**, 2S–10S.
- International Interferon- α Hepatocellular Carcinoma Study Group (1998) Effect of interferon- α on progression of cirrhosis to hepatocellular carcinoma: a retrospective cohort study. *Lancet*, **351**, 1535–1539.
- Jameel, S., Durgapal, H., Habibullah, C.M. *et al.* (1992) Enteric non-A, non-B hepatitis: epidemics, animal transmission, and hepatitis E virus detection by the polymerase chain reaction. *Journal of Medical Virology*, **37**, 263–270.
- Kakumu, S., Arao, M., Yoshioka, K. *et al.* (1990) Recombinant human alpha-interferon therapy for chronic non-A, non-B hepatitis: second report. *American Journal of Gastroenterology*, **85**, 655–659.
- Kaplan, G., Totsuka, A., Thompson, P. *et al.* (1996) Identification of a surface glycoprotein on African green monkey kidney cells as a receptor for hepatitis A virus. *EMBO Journal*, **15**, 4282–4296.
- Karayiannis, P., Saldanha, J., Monjardino, J. *et al.* (1993) Immunisation of woodchucks with hepatitis delta antigen expressed by recombinant vaccinia and baculoviruses, controls HDV superinfection. *Progress in Clinical Biological Research* **382**, 193–199.
- Khuroo, M.S. (1980) Study of an epidemic of non-A, non-B hepatitis. Possibility of another human hepatitis virus distinct from post-transfusion non-A, non-B type. *American Journal of Medicine*, **68**, 818–824.
- Korenman, J., Baker, B., Waggoner, J. *et al.* (1991) Long-term remission of chronic hepatitis B after alpha-interferon therapy. *Annals of Internal Medicine*, **114**, 629–634.
- Krogsgaard, K., Kryger, P., Aldershvile, J. *et al.* and the Copenhagen Hepatitis Acute Programme (1985) Hepatitis B virus DNA in serum from patients with acute hepatitis B. *Hepatology*, **5**, 10–13.
- Kuo, G., Choo, Q.-L., Alter, H.J. *et al.* (1989) An assay for circulating antibodies to a major etiologic virus of human non-A, non-B hepatitis. *Science*, **244**, 362–364.
- Lai, M.M.C. (1995) Molecular biologic and pathogenetic analysis of hepatitis delta virus. *Journal of Hepatology*, **22**, 127–131.
- Lai, M.Y., Kao, J.H., Yang, P.M. *et al.* (1996) Long-term efficacy of ribavirin plus interferon alfa in the treatment of chronic hepatitis C. *Gastroenterology*, **111**, 1307–1312.
- Lau, D.T., Everhart, J., Kleiner, D.E. *et al.* (1997) Long-term follow-up of patients with chronic hepatitis B treated with interferon alfa. *Gastroenterology*, **113**, 1660–1667.
- Lazinski, D.W. and Taylor, J.M. (1995) Intracellular cleavage and ligation of hepatitis delta virus genomic RNA: regulation of ribozyme activity by *cis*-acting sequences and host factors. *Journal of Virology*, **69**, 1190–1200.
- Lien, J.-M., Aldrich, C.E. and Mason, W.S. (1986) Evidence that a capped oligonucleotide is the primer for duck hepatitis B virus plus-strand DNA synthesis. *Journal of Virology*, **57**, 229–236.
- Lin, C.-Y. (1995) Treatment of hepatitis B virus-associated membranous nephropathy with recombinant alpha-interferon. *Kidney International*, **47**, 225–230.
- Lindsay, K.L. (1997) Therapy of hepatitis C: overview. *Hepatology*, **26**, 71S–77S.
- Ling, R., Mutimer, D., Ahmed, N. *et al.* (1996) Selection of mutations in the hepatitis B virus polymerase during therapy of transplant recipients with lamivudine. *Hepatology*, **24**, 711–713.
- Linnen, J., Wages, J., ZhangKeck, Z.Y. *et al.* (1996) Molecular cloning and disease association of hepatitis G virus: a transfection-transmissible agent. *Science*, **271**, 505–508.
- Lisker-Melman, M., Webb, D., Di-Bisceglie, A.M. *et al.* (1989) Glomerulonephritis caused by chronic hepatitis B virus infection: treatment with recombinant human alpha-interferon. *Annals of Internal Medicine*, **111**, 479–483.
- Lok, A.S., Lai, C.L., Wu, P.C. *et al.* (1989) Treatment of chronic hepatitis B with interferon: experience in Asian patients. *Seminars in Liver Disease*, **9**, 249–253.
- Lok, A.S.F., Kwan, W., Moeckli, R. *et al.* (1992) Seroepidemiological survey of hepatitis E in Hong Kong by recombinant-based enzyme immunoassays. *Lancet*, **340**, 1205–1208.
- McMahon, G., Ehrlich, P.H., Moustafa, Z.A. *et al.* (1992) Genetic alterations in the gene encoding the major HBsAg—DNA and immunological analysis of recurrent HBsAg derived from monoclonal antibody-treated liver transplant patients. *Hepa-*

- tology* **15**, 757–66.
- Marcellin, P., Pialoux, G., Girard, P.M. *et al.* (1989) Absence of effect of zidovudine on replication of hepatitis B virus in patients with chronic HIV and HBV infection. *New England Journal of Medicine*, **321**, 1758–1758.
- Meng, X.J., Purcell, R.H., Halbur, P.G. *et al.* (1997) A novel virus in swine is closely related to the human hepatitis E virus. *Proceedings of the National Academy of Sciences of the USA*, **94**, 9860–9865.
- Milich, D.R., Thornton, G.B., Neurath, A.R. *et al.* (1985) Enhanced immunogenicity of the pre-S region of hepatitis B surface antigen. *Science*, **228**, 1195–1199.
- Milich, D.R., Schödel, F., Peterson, D.L. *et al.* (1995a) Characterization of self-reactive T cells that evade tolerance in hepatitis B e antigen transgenic mice. *European Journal of Immunology*, **25**, 1663–1672.
- Milich, D.R., Wolf, S.F., Hughes, J.L. *et al.* (1995b) Interleukin 12 suppresses autoantibody production by reversing helper T-cell phenotype in hepatitis B e antigen transgenic mice. *Proceedings of the National Academy of Sciences of the USA*, **92**, 6847–6851.
- Miyakawa, H., Sato, C., Izumi, N. *et al.* (1993) Hepatitis C virus infection in alcoholic liver cirrhosis in Japan: its contribution to the development of hepatocellular carcinoma. *Alcohol and Alcoholism*, **Suppl. 1A**, 85–90.
- Mushahwar, I.K., Erker, J.C., Muerhoff, A.S., *et al.* (1999) Molecular and biophysical characterization of TT virus: evidence for a new virus family infecting humans. *Proceedings of the National Academy of Sciences, USA*, **96**, 3177–3182.
- Mutchnick, M.G., Appelman, H.D., Chung, H.T. *et al.* (1991) Thymosin treatment of chronic hepatitis B: a placebo-controlled pilot trial. *Hepatology*, **14**, 409–415.
- Naik, S.R., Aggarwal, R., Salunke, P.N. *et al.* (1992) A large waterborne viral hepatitis E epidemic in Kanpur, India. *Bulletin of the World Health Organization*, **70**, 597–604.
- Naoumov, N.V., Petrova, E.P., Thomas, M.G. *et al.* (1998) Presence of newly described DNA virus (TTV) in patients with liver disease. *Lancet*, **352**, 195–197.
- Neurath, A.R., Kent, S.B., Strick, N. *et al.* (1986) Identification and chemical synthesis of a host cell receptor binding site on hepatitis B virus. *Cell*, **46**, 429–436.
- Niederau, C., Heintges, T., Lange, S. *et al.* (1996) Long-term follow-up of HBeAg-positive patients treated with interferon alpha for chronic hepatitis B. *New England Journal of Medicine*, **334**, 1422–1427.
- Nishiguchi, S., Kuroki, T., Nakatani, S. *et al.* (1995) Randomised trial of effects of interferon- α on incidence of hepatocellular carcinoma in chronic active hepatitis C with cirrhosis. *Lancet*, **346**, 1051–1055.
- Nishizawa, T., Okamoto, H., Konishi, K. *et al.* (1997) A novel DNA virus (TTV) associated with elevated transaminase levels in posttransfusion hepatitis of unknown etiology. *Biochemical and Biophysical Research Communications*, **241**, 92–97.
- Okamoto, H., Nishizawa, T., Kato, N. *et al.* (1998) Molecular cloning and characterisation of a novel DNA virus (TTV) associated with posttransfusion hepatitis of unknown aetiology. *Hepatology Research*, **10**, 1–16.
- Oon, C.J., Lim, G.K., Ye, Z. *et al.* (1995) Molecular epidemiology of hepatitis B virus vaccine variants in Singapore. *Vaccine*, **13**, 699–702.
- Panda, S.K. and Nanda, S.K. (1997) Development of vaccines against hepatitis E virus infection. In *The Molecular Medicine of Viral Hepatitis* (eds T.J. Harrison and A.J. Zuckerman) pp 45–62. Wiley, Chichester.
- Perrillo, R.P., Regenstein, F.G., Peters, M.G. *et al.* (1988) Prednisone withdrawal followed by recombinant alpha interferon in the treatment of chronic type B hepatitis. A randomized, controlled trial. *Annals of Internal Medicine*, **109**, 95–100.
- Perrillo, R.P., Schiff, E.R., Davis, G.L. *et al.* and the Hepatitis Interventional Therapy Group (1990) A randomized, controlled trial of interferon alfa-2b alone and after prednisone withdrawal for the treatment of chronic hepatitis B. *New England Journal of Medicine*, **323**, 295–301.
- Ping, L.H. and Lemon, S.M. (1992) Antigenic structure of human hepatitis-A virus defined by analysis of escape mutants selected against murine monoclonal antibodies: *Journal of Virology*, **66**, 2208–2216.
- Pol, S. (1995) Immunotherapy of chronic hepatitis B by anti HBV vaccine. *Biomedical Pharmacotherapy*, **49**, 105–109.
- Pol, S., Driss, F., Michel, M.-L. *et al.* (1994) Specific vaccine therapy in chronic hepatitis B infection. *Lancet*, **344**, 342–342.
- Purcell, R.H. and Ticehurst, J.R. (1988) Enterically transmitted non-A, non-B hepatitis: epidemiology and clinical characteristics. In *Viral Hepatitis and Liver Disease* (ed. A.J. Zuckerman), pp 131–137. Liss, New York.
- Purdy, M.A., McCaustland, K.A., Krawczynski, K. *et al.* (1993) Preliminary evidence that a trpE-fusion protein protects cynomolgus macaques against challenge with wild-type hepatitis E virus (HEV). *Journal of Medical Virology*, **41**, 90–94.
- Reichard, O., Andersson, J., Schvarcz, R. *et al.* (1991) Ribavirin treatment for chronic hepatitis C. *Lancet*, **337**, 1058–1061.
- Reichard, O., Schvarcz, R. and Weiland, O. (1997) Therapy of hepatitis C: alpha interferon and ribavirin. *Hepatology*, **26**, 108S–111S.
- Rizzetto, M. (1996) Changing epidemiology of viral hepatitis worldwide. Implications for prevention and therapy. *Medical Microbiology Letters*, **5**, 455–457.
- Rizzetto, M., Canese, M.G., Arico, S. *et al.* (1977) Immunofluorescence detection of new antigen-antibody system (delta/anti-delta) associated to hepatitis B virus in liver and in serum of HBsAg carriers. *Gut*, **18**, 997–1003.
- Rizzetto, M., Rosina, F., Saracco, G. *et al.* (1986) Treatment of chronic delta hepatitis with alpha-2 recombinant interferon. *Journal of Hepatology*, **2**, S229–S233.
- Rosina, F., Pintus, C., Meschievitz, C. *et al.* (1991) Long term interferon treatment of chronic delta hepatitis: a multicenter Italian study. *Progress in Clinical and Biological Research*, **364**, 385–391.
- Ruiz-Moreno, M., Jimenez, J., Porres, J.C. *et al.* (1990) A controlled trial of recombinant interferon-alpha in Caucasian children with chronic hepatitis B. *Digestion*, **45**, 26–33.
- Saracco, G., Mazzella, G., Rosina, F. *et al.* (1989) A controlled trial of human lymphoblastoid interferon in chronic hepatitis B in Italy. *Hepatology*, **10**, 336–341.
- Sawada, M., Takada, A., Takase, S. *et al.* (1993) Effects of alcohol on the replication of hepatitis C virus. *Alcohol and Alcoholism*, **Suppl. 1B**, 85–90.
- Schalm, S.W., Brouwer, J.T., Chemello, L. *et al.* (1996) Interferon-ribavirin combination therapy for chronic hepatitis C. *Digestive Diseases and Sciences*, **41**, 131S–134S.
- Schalm, S.W., Hansen, B.E., Chemello, L. *et al.* (1997) Ribavirin enhances the efficacy but not the adverse effects of interferon in

- chronic hepatitis C: meta-analysis of individual patient data from European centers. *Journal of Hepatology*, **26**, 961–966.
- Simmonds, P., Alberti, A., Alter, H.J. *et al.* (1994) A proposed system for the nomenclature of hepatitis C viral genotypes. *Hepatology*, **19**, 1321–1324.
- Simmonds, P., Davidson, F., Lycett, C. *et al.* (1998) Detection of a novel DNA virus (TTV) in blood donors and blood products. *Lancet*, **352**, 191–195.
- Simons, J.N., Leary, T.P., Dawson, G.J. *et al.* (1995a) Isolation of novel virus-like sequences associated with human hepatitis. *Nature Medicine*, **1**, 564–569.
- Simons, J.N., Pilot-Matias, T.J., Leary, T.P. *et al.* (1995b) Identification of two flavivirus-like genomes in the GB hepatitis agent. *Proceedings of the National Academy of Sciences of the USA*, **92**, 3401–3405.
- Sterneck, M., Gunther, S., Santantonio, T. *et al.* (1996) Hepatitis B virus genomes of patients with fulminant hepatitis do not share a specific mutation. *Hepatology*, **24**, 300–306.
- Summers, J. and Mason, W.S. (1982) Replication of the genome of a hepatitis B-like virus by reverse transcription of an RNA intermediate. *Cell*, **29**, 403–415.
- Tam, A.W., Smith, M.M., Guerra, M.E., *et al.* (1991) Hepatitis E virus (HEV): molecular cloning and sequencing of the full-length viral genome. *Virology*, **185**, 120–131.
- Taylor, J. (1997) Replication of hepatitis D virus. In *The Molecular Medicine of Viral Hepatitis* (eds. T.J. Harrison and A.J. Zuckerman), pp 1331–1340. Wiley, Chichester.
- Thursz, M.R., Kwiatkowski, D., Allsopp, C.E.M. *et al.* (1995) Association between an MHC class II allele and clearance of hepatitis B virus in the Gambia. *New England Journal of Medicine*, **332**, 1065–1069.
- Tsarev, S.A., Tsareva, T.S., Emerson, S.U. *et al.* (1994) Successful passive and active immunization of cynomolgus monkeys against hepatitis E. *Proceedings of the National Academy of Sciences of the USA*, **91**, 10198–10202.
- Tsiquaye, K.N., Slomka, M.J. and Maung, M. (1994) Oral famciclovir against duck hepatitis B virus replication in hepatic and nonhepatic tissues of ducklings infected *in ovo*. *Journal of Medical Virology*, **42**, 306–310.
- Tsui, L.V., Guidotti, L.G., Ishikawa, T. *et al.* (1995) Posttranscriptional clearance of hepatitis B virus RNA by cytotoxic T lymphocyte-activated hepatocytes. *Proceedings of the National Academy of Sciences of the USA*, **92**, 12398–12402.
- Vallbracht, A. and Fleischer, B. (1992) Immune pathogenesis of hepatitis A. *Archives of Virology. Supplementum*, **4**, 3.
- Vento, S., Garofano, T., Di Perri, G. *et al.* (1991) Identification of hepatitis A virus as a trigger for autoimmune chronic hepatitis type 1 in susceptible individuals. *Lancet*, **337**, 1183.
- Wang, J., Chenivesse, X., Henglein, B. *et al.* (1990) Hepatitis B virus integration in a cyclin A gene in a hepatocellular carcinoma. *Nature*, **343**, 555–557.
- Wei, Y., Fourel, G., Ponzetto, A. *et al.* (1992) Hepadnavirus integration: mechanisms of action of the N-myc2 retrotransposon in woodchuck liver tumours. *Journal of Virology*, **66**, 5265–5276.
- Werzberger, A., Mensch, B., Kuter, B. *et al.* (1992) A controlled trial of a formalin-inactivated hepatitis A vaccine in healthy children. *New England Journal of Medicine*, **327**, 453–457.
- Whalen, R.G. and Davis, H.L. (1995) DNA-mediated immunization and the energetic immune response to hepatitis B surface antigen. *Clinical Immunology Immunopathology*, **75**, 1–12.
- Zuckerman, J.N. (1996) Nonresponse to hepatitis B vaccines and the kinetics of anti-HBs production. *Journal of Medical Virology*, **50**, 283–288.
- Zuckerman, J.N., Cockcroft, A. and Zuckerman, A.J. (1992) Site of injection for vaccination. *BMJ*, **305**, 1158.
- Zuckerman, J.N., Sabin, C., Craig, F.M. *et al.* (1997) Immune response to a new hepatitis B vaccine in healthcare workers who had not responded to standard vaccine: randomised double blind dose-response study. *BMJ*, **314**, 329–333.

Viruses Associated with Acute Diarrhoeal Disease

Ulrich Desselberger

Addenbrooke's Hospital, Cambridge, UK

INTRODUCTION

Gastroenteritis in humans can be caused by viruses, bacteria and parasites. The pathogenesis differs considerably, depending on the infectious agent. Clinical symptoms, however, are similar and range from mainly upper gastrointestinal symptoms including vomiting, to acute watery or bloody diarrhoea without any vomiting, or combinations thereof. Viral gastroenteritis is a global problem in infants and young children (Bern *et al.*, 1992).

Viruses which are known to cause human gastroenteritis (Figure 4.1) belong to genera of different virus families (Blacklow and Greenberg, 1991; Murphy *et al.*, 1995):

- rotaviruses (*Reoviridae*)
- enteric adenoviruses (*Adenoviridae*)
- small round structured viruses (SRSVs) and classic human caliciviruses (all *Caliciviridae*)
- astroviruses (*Astroviridae*).

In terms of relative incidence frequency, rotaviruses account for approximately 70%, enteric adenoviruses for 12% and caliciviruses and astroviruses for 8% each of all cases of viral gastroenteritides in children (Krajden *et al.*, 1990; Bern and Glass, 1994).

Other viruses found in the gastrointestinal tract are not regularly associated with disease of the human gut but may cause diarrhoea in animals:

- enteroviruses (*Picornaviridae*)
- reoviruses (*Reoviridae*)
- toroviruses (*Coronaviridae*)
- coronaviruses (*Coronaviridae*)
- parvoviruses (*Parvoviridae*).

Human immunodeficiency virus (HIV; a member of the *Retroviridae* family) can infect the gut directly. Under conditions of immunosuppression the following viruses were also found to infect the gut and cause gut disease:

- Herpes simplex viruses (*Herpesviridae*)
- Cytomegalovirus (*Herpesviridae*)
- Picobirnaviruses (*Birnaviridae*).

Many of the obligatory gastroenteritis viruses do not grow at all, or not very well, in tissue culture, and therefore virus isolation is not the diagnostic method of choice. By contrast, electron microscopy permits the differentiation of viruses on the basis of their characteristic morphology (Figure 4.1), although the sensitivity of detection (approximately 10^6 particles per millilitre) is low. In general, detection of rotaviruses is easy as this virus is shed in very large numbers (up to 10^{11} particles per millilitre of faeces) during the peak of the illness. Other viruses, particularly SRSVs and caliciviruses, are often only produced in relatively low numbers, below the detection level of electron microscopy and only very early into the clinically apparent disease. Recently,

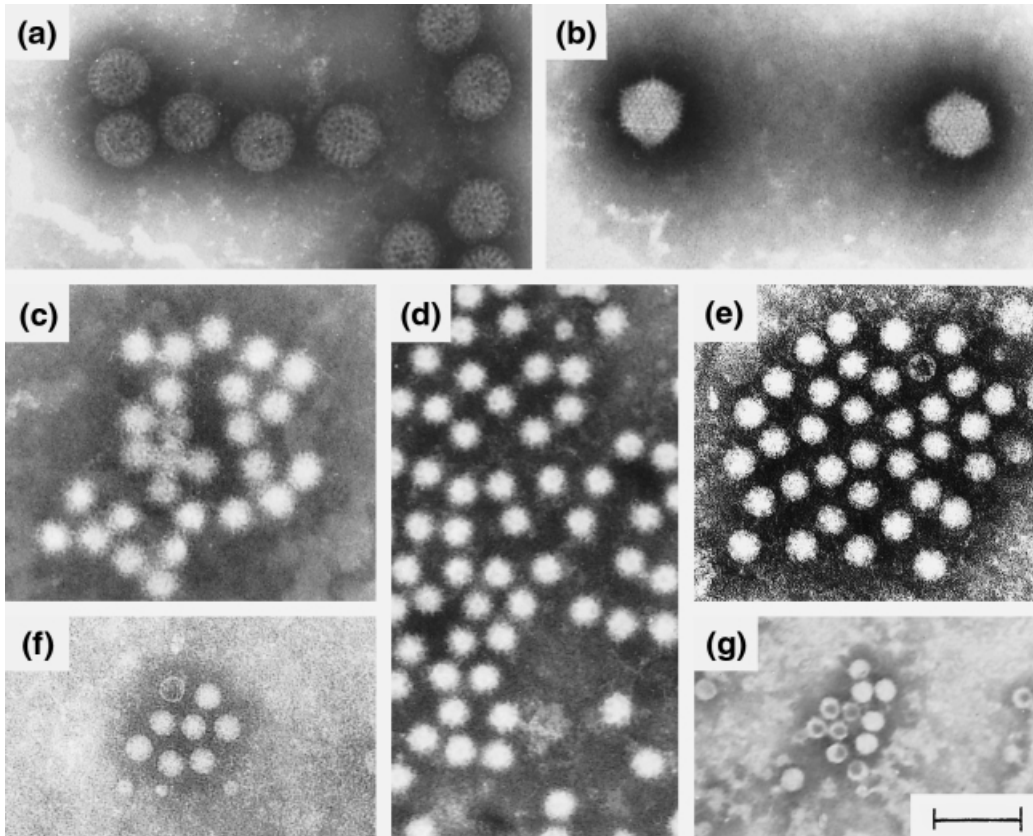

Figure 4.1 Electron micrographs of (a) rotavirus, (b) enteric adenovirus, (c) SRSV, (d) calicivirus, (e) astrovirus, (f) enterovirus and (g) parvovirus. (Negative staining with 3% phosphotungstate, pH 6.3; bar = 100 nm) (Astroviruses: courtesy Mr T. Lee and Dr J. Kurtz, Oxford Public Health Laboratory; all other viruses: courtesy Dr J. Gray, Clinical Microbiology and Public Health Laboratory, Cambridge)

the method of reverse transcription (RT)—polymerase chain reaction (PCR) and serological techniques using recombinant antigens have greatly helped to estimate the true extent of human infections with SRSVs and astroviruses, which was found to be much higher than previously thought.

Most viral gastroenteritis infections follow two distinct epidemiological patterns. In childhood, diarrhoea occurs as endemic disease, mainly caused by rotaviruses of group A, adenoviruses of subgroup F, astroviruses and classic human caliciviruses. By the age of 5 years many children have been infected with these agents, often without apparent symptoms. The main mode of transmission seems to be orofaecal, possibly also by droplets and close contact. By contrast, epidemics are mainly caused by SRSVs and sometimes by astroviruses and group B and C rotaviruses. All ages can be affected, and viruses are quite often transmitted by

infected food (e.g. shellfish) or water (Hedberg and Osterholm, 1993).

In essence, treatment follows guidelines established in 1985, mainly using oral rehydration fluids containing electrolytes and sugar (reviewed by Bhan *et al.*, 1994; Desselberger, 1999). Bismuth subsalicylate has been found to be beneficial in children with acute watery diarrhoea (Figueroa-Quintanilla *et al.*, 1993). Agents such as diphenoxylate or loperamide against abdominal cramping should be avoided as they can have side effects. In severe cases rapid fluid replacement by parenteral administration may be required. In developing countries where children are often malnourished as well, supplementary nutrition is an important component of the therapy. Public health measures to confine outbreaks include frequent handwashing, proper disinfection and removal of infected faeces and contaminated food or water, and taking infec-

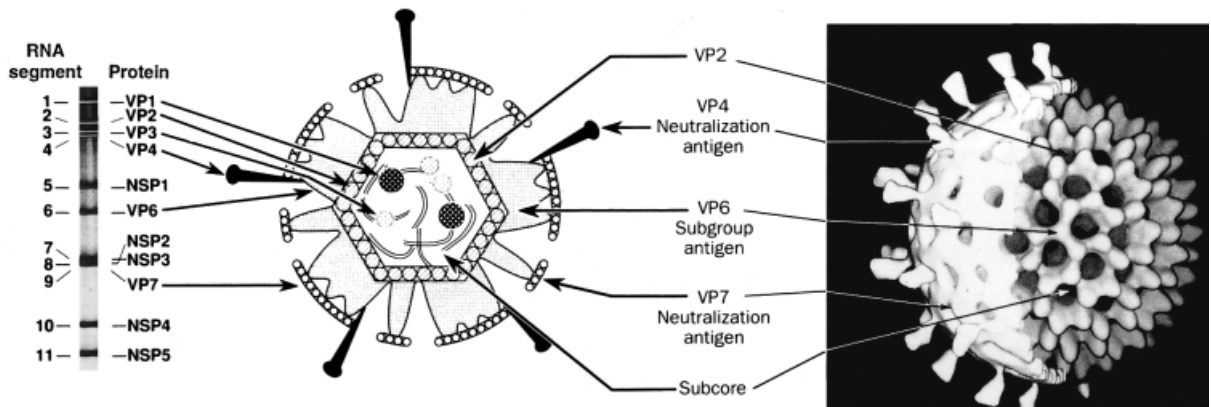

Figure 4.2 RNA profile (10% SDS polyacrylamide gel, silver stained), protein products (gene protein assignment) and particle structure (reconstruction from cryoelectron micrographs) of rotavirus. (From Mattion *et al.*, 1994; with permission of authors and publishers)

ted individuals out of work. Outbreaks in clinical wards may require temporary closure to new admissions and restrictions on placements of staff.

Viruses regularly and irregularly causing acute gastroenteritis will be briefly described below (for concise reviews see Hart and Cunliffe, 1997, Desselberger, 1998b). According to the relative degree of importance of different viruses for clinical human disease, rotaviruses are presented more extensively than the other viruses.

ROTAVIRUSES

Structure, Genome and Gene Protein Assignment

Rotaviruses are the major cause of infantile gastroenteritis worldwide and also of acute diarrhoea in the young of many mammalian species (calves, piglets, lambs, fowl, etc.). Rotaviruses possess a genome consisting of 11 segments of double-stranded (ds) RNA encoding six structural proteins (VP1, VP2, VP3, VP4, VP6 and VP7) and five non-structural proteins (NSP1–NSP5). The structural proteins constitute the core or inner layer (VP1–VP3), an inner shell or intermediate layer (VP6), and an outer shell/layer (VP4, VP7) of the double-shelled/triple-layered particle (Figure 4.2). The wheel-like structure of the particle (Latin *rota* = wheel) as seen by electron microscopy is pathognomonic (Figure 4.1). Details of the three-dimensional structure have

been elucidated in a number of excellent studies by the groups of Prasad and Chiu (Prasad *et al.*, 1988, 1990, 1996; Shaw *et al.*, 1993; Lawton *et al.*, 1997a, 1997b; Prasad and Estes, 1997) and Yeager (Yeager *et al.*, 1990, 1994). According to their findings the double-shelled capsid is ordered in 6-, 5- and 3-fold symmetry axes and is perforated by 132 aqueous channels (in 3 symmetry positions). Complete gene protein assignments have been established for several strains; the protein function correlations are only partially known. Details on sizes of RNA segments and their products as well as on post-translational modification and possible function(s) of the viral proteins are summarized in Table 4.1. Functions are reviewed in more detail below.

Classification

A classification scheme for rotaviruses has been derived from immunological reactivities of three of its components as well as from genomic sequence comparisons and has been established as follows (Estes, 1996):

1. According to the serological cross-reactivity of the inner capsid protein VP6, five groups (A–E) have been firmly established, and two more groups (F,G) are likely to exist. Within group A rotaviruses, there are subgroups (I; II; I + II; nonI,nonII) according to their exclusive reactivities with two VP6-specific monoclonal antibodies.

Table 4.1 Genes, gene protein assignments and function(s) of proteins of group A rotaviruses

RNA Segment	Size (bp)	Protein product		Post-translational modification	Location and function
		Designation	Deduced molecular weight (kDa)		
1	3302	VP1	125.0	—	Inner core protein; RNA polymerase
2	2690	VP2	102.7	Myristylation	Inner core protein; RNA binding; leucine zipper
3	2591	VP3	88.0	—	Inner core protein; guanylyl transferase
4	2362	VP4	86.7	Proteolytic cleavage (→ VP5* + VP8*)	Surface protein (dimer); haemagglutinin; neutralization antigen; fusogenic protein; virulence; pathogenicity;
5	1611	VP5 (NS53;NSP1)	58.6	—	Non-structural; zinc fingers; assembly
6	1356	VP6	44.8	Myristylation	Inner capsid protein (trimer); group and subgroup antigen
7 ^a	1104	VP8 (NS35;NSP2)	36.7	—	Nonstructural, RNA replication?
8 ^a	1059	VP9 (NS34;NSP3)	34.6	—	Non-structural; RNA binding
9 ^a	1062	VP7(1)	37.4	Cleavage of signal sequence; glycosylation	Surface glycoprotein; Neutralization antigen
10	751	VP7(2) VP12 (NS20;NSP4)	33.9 20.3	Glycosylation → VP10(NS29)	Non-structural; intracellular receptor; morphogenesis; viral enterotoxin
11	667	VP11 (NS26;NSP5)	21.7	Phosphorylation	Non-structural

^a This gene-protein assignment is for SA11 rotavirus. Slightly modified from Mattion *et al.* (1994).

2. Both surface proteins, VP4 and VP7, elicit the production of antibodies which neutralize *in vitro* and *in vivo* (Offit *et al.*, 1986a, 1986b; Green *et al.*, 1992) and are thought to be involved in protection. Therefore, a dual classification scheme into types similar to that developed for influenza viruses has been established (so far only for group A rotaviruses): it differentiates G types (VP7-specific, G for glycoprotein) and P types (VP4-specific, P for protease-sensitive protein). So far, 14 different G types and more than 20 P types have been detected, indicating extensive genomic diversity within group A rotaviruses. Whereas the correlation of G serotypes and their genotypes is practically complete, for many P genotypes no serotype has yet been established. Thus, it has been agreed to designate the P serotype and genotype separately but jointly, the latter in square brackets: for example, the human Wa strain is classified as G1P1A[8], the human DS-1 strain as G2 P1B[4], etc. (For a recent update of the nomenclature of human and animal rotavirus strains see Estes, 1996.)

As VP4 and VP7 are coded for by different RNA segments (segment 4 and 7, 8 or 9 depending on strain, respectively; see Table 4.1) and as rotaviruses were found to reassort readily in doubly-infected cells *in vitro* and *in vivo* (Garbarg-Chenon *et al.*, 1986; Urasawa *et al.*, 1986), various combinations of VP4 and VP7 types in natural rotavirus isolates have been observed (Estes, 1996; Desselberger, 1998a; Table 4.2).

Replication

Rotaviruses spread via the orofaecal route and infect the small intestine after oral ingestion. Multiplication occurs in the mature epithelial cells at the tips of the villi of the small intestine. Rotaviruses grow well in secondary monkey kidney cells and in permanent monkey kidney cell lines (MA104) in the presence of trypsin, and therefore their replication *in vitro* could be studied in detail (Estes, 1996). Double-shelled particles attach to the host cells via

Table 4.2 Rotavirus G types (VP7 specific) and P types (VP4 specific) in the combinations found in natural isolates of animals (A), humans (H) or both animals and humans (B)

P type	G type														NK	
	1	2	3	4	5	6	7	8	9	10	11	12	13	14		
1			A			A										
2			A													
3			B													
4		H	A									A				
5						A		A		A						A
6	H	H	A	B												H
7			A		A											A
8	H		H	H					H							
9	H		B		A	H				H						
10								H								
11			A			A			H	B						A
12			A			B		A		A				A		
13			B		A	H										
14										B						
15			A													
16										A						
17			A				A									A
18			A													
19			A													
NK	B	H	B	B	A	A	A	H	H	B		H	A	A		

NK = not known.

All G types are genotypes and serotypes, not all P types (genotypes) have yet been differentiated as serotypes (Estes, 1996).

[Modified from Desselberger, 1998a]

the outer capsid protein VP4 (Ludert *et al.*, 1996). The cellular receptor is not fully characterized yet but has a sialic acid component. There may be coreceptors. Virus entry is by receptor-mediated endocytosis or direct penetration. Replication is exclusively in the cytoplasm. After removal of the outer capsid, the viral RNA-dependent RNA polymerase (coded for by RNA 1) is activated, and large numbers of positive-stranded RNAs are transcribed, which leave the single-shelled particle via its aqueous channels. They act as mRNAs, and their translation products accumulate in the cytoplasm. Single-shelled particles form, consisting of VP1, VP2, VP3 and VP6 and containing one genome equivalent of packaged single-stranded RNA (which is then replicated to form dsRNA). They accumulate and form pseudocrystalline aggregates termed '*viroplasm*' (intracytoplasmic inclusion bodies). By budding through the rough endoplasmic reticulum (RER), single-shelled particles incorporate VP7 and VP4 to form the outer capsid (with a transient, RER-derived envelope, which is, how-

ever, shed before complete maturation). Double-shelled infectious virions are released by cell lysis. The non-structural proteins have been implicated as supporting various stages of morphogenesis, and NSP4 was proposed to act as intracellular receptor in the RER to attract single-shelled particles for maturation to double-shelled particles. (For details of structure-function correlations and replication see Estes, 1996; Prasad and Estes, 1997; Lawton *et al.*, 1997a, 1997b.) In immunodeficient hosts and under certain experimental conditions, rotaviruses undergo genome rearrangements (Desselberger, 1996).

Pathogenesis

Increasing cellular necrosis of the gut epithelium leads to villous atrophy, loss of digestive enzymes, a reduction of absorption and increased osmotic pressure in the gut lumen, resulting in the onset of

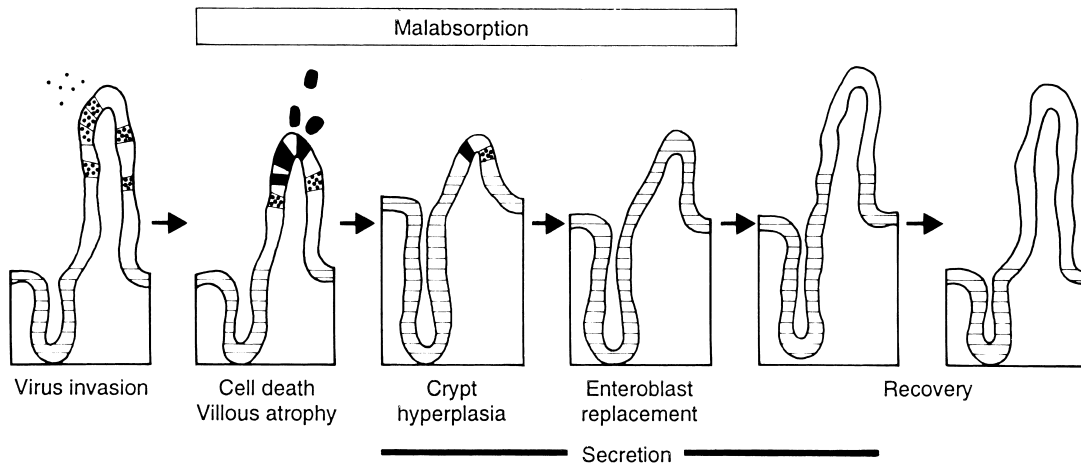

Figure 4.3 Rotavirus pathogenesis. Development of damage to gut mucosa, diarrhoea and repair. (From Phillips, 1989; with permission of author and publisher)

diarrhoea. This is followed by a reactive crypt cell hyperplasia accompanied by increased fluid secretion, which also contributes to the severity of diarrhoea. Local pathogenesis is shown diagrammatically in Figure 4.3.

Viral factors determining pathogenicity of rotaviruses have been investigated in several animal models (piglets, mice, rabbits; for review see Burke and Desselberger, 1996). The protein product of RNA segment 4, VP4, has been found to be a major determinant of pathogenicity in several systems, but products of other structural genes (VP3, VP7) and of non-structural genes (NSP1, NSP2, NSP4) have also been implicated (Broome *et al.*, 1993; Hoshino *et al.*, 1995). NSP4 has been described recently as a viral enterotoxin (Tian *et al.* 1994, 1995; Ball *et al.*, 1996).

Immune Responses and Correlates of Protection

After neonatal or primary rotavirus infection a mainly serotype-specific humoral immune response is elicited, but there is also partial protection developing against subsequent rotavirus infections by other serotypes (Velasquez *et al.*, 1996). The exact correlates of protection remain to be determined (Offit, 1994), but the best are at present levels of rotavirus-specific coproantibodies of the IgA subclass (Coulson *et al.*, 1992; Feng *et al.*, 1994, 1997;

Yuan *et al.*, 1996). These might be directed towards the type-specifying antigens VP7 and VP4, but also towards the inner capsid protein VP6 (Burns *et al.*, 1996; Herrmann *et al.*, 1996; Feng *et al.*, 1997). There is also a rotavirus-specific cytotoxic T cell response (Dharakul *et al.*, 1990), but its exact role in overcoming the infection or in protection against subsequent infections is not known (Offit, 1994; Franco and Greenberg, 1995). Natural infection or appropriate vaccination (see below) seem to protect from severe disease in subsequent infections (Coulson *et al.*, 1992; Velasquez *et al.*, 1996), even if the serotype of the challenging virus differs from that of the previous infections or in the vaccine.

Illness, Diagnosis and Treatment

After a short incubation period of 1–2 days the onset of the illness is sudden, with watery diarrhoea lasting 4–7 days, vomiting and rapid dehydration. All degrees of severity of disease are seen, including inapparent infections by so-called 'nursery strains' (Gorziglia *et al.*, 1988), and chronic infections and hepatitis in children with immunodeficiencies (Chrystie *et al.*, 1982; Gilger *et al.*, 1992).

Diagnosis of the infection is relatively easy as large numbers of virus particles are shed in faeces. The main techniques used are ELISAs, passive particle agglutination tests and, when searching comprehensively for diarrhoeogenic viruses, electron

microscopy. Serological assays are being used to establish G and P types of rotavirus isolates but this depends on the presence of double-shelled virus particles in the clinical specimen. Molecular techniques are therefore increasingly applied for the purpose of detection and typing. Rotavirus-specific oligonucleotide primers complementary to common and type-specific regions of the VP7 and VP4 genes allow sensitive detection and typing for both G and P types, respectively, by RT-PCR (Gouvea *et al.*, 1990; Gentsch *et al.*, 1992).

Treatment is by oral, subcutaneous or intravenous rehydration and pain relief as indicated above. Oral immunoglobulins seem to have an effect on the duration of diarrhoea and virus shedding (Guarino *et al.*, 1994; Kanfer *et al.*, 1994; Desselberger, 1999).

Epidemiology

The epidemiology of group A rotavirus infections is complex, as, at any one time within a geographical location, cocirculation of rotaviruses of different G types has been found in various surveys (e.g. Beards *et al.*, 1989; Noel *et al.*, 1991; Gentsch *et al.*, 1996; Ramachandran *et al.*, 1998). The relative incidence of G types also changes over time in the same location. Approximately 95% of cocirculating strains are types G1–G4 in most places, typically G1P1A[8], G2P1B[4], G3P1A[8] and G4P1A[8], but other G types may be represented at high frequencies, particularly in tropical areas (Gentsch *et al.*, 1996). Recently, G9 rotaviruses have been isolated as the main outbreak strains in several locations in the United States (Ramachandran *et al.*, 1998). Group B rotaviruses have caused outbreaks of diarrhoea in children and adults in China, but apparently not elsewhere (Hung, 1988). Group C rotaviruses are associated with small outbreaks in humans (Matsumoto *et al.*, 1989; Caul *et al.*, 1990; Jiang *et al.*, 1995).

Vaccine Development

Rotavirus infections have been recognized as a major viral infection in children associated with > 800 000 annual cases of childhood mortality worldwide (Bern *et al.*, 1992), and therefore develop-

ment of vaccine candidates has been a major goal and has been in progress since the early 1980s. Results have been mixed for some time, owing to the enormous genomic and antigenic diversity of rotaviruses (for review see Desselberger, 1993, 1998c; Kapikian, 1994; Midthun and Kapikian, 1996). Mainly animal rotaviruses (of simian or bovine origin) have been used as live attenuated vaccines. In many cases protection from *infection and/or mild disease* was only modest (40–50%). By contrast, 70–80% protection from *severe disease including dehydration* was recently achieved (Bernstein *et al.*, 1995; Rennels *et al.*, 1996; Joensuu *et al.*, 1997; Perez-Schael *et al.*, 1997), particularly when applying a cocktail of viruses, for example as a tetravalent vaccine containing a rhesus monkey rotavirus (RRV) of G3 type and monoreassortants individually carrying the VP7 gene of human serotypes G1, G2 and G4 in the RRV genetic background. A tetravalent HRRV-based vaccine received Food and Drug Administration (FDA) approval as a universal vaccine in the United States in August 1998, and an application for approval in Europe is pending. Extensive use of the vaccine is expected, and recommendations for its usage have been issued (ACIP, 1999). Proof of its effectiveness on a large scale will require implementation studies.

Other approaches to immunization are under investigation at present: for example, application of virus-like particles (VLPs) originating from baculovirus recombinants expressing structural proteins (VP2, VP6, VP4, VP7) (Conner *et al.*, 1996); enhancement of rotavirus immunogenicity by microencapsulation (Offit *et al.*, 1994); and DNA-based vaccines (Herrmann *et al.*, 1996; Chen *et al.*, 1997, 1998).

ENTERIC ADENOVIRUSES

Genome and Structure

Adenoviruses are non-enveloped icosahedral viruses of 70–80 nm diameter, possessing a genome of linear dsDNA of approximately 35 000 bp and a capsid with 240 hexons and 12 pentons with projecting fibres at the corners as capsomers (Shenk, 1996). Their three-dimensional structure has been elucidated (Stewart *et al.*, 1991).

Classification

Human adenoviruses occur in 49 distinct serotypes ordered into six different subgroups (A–F). The classification is based on immunological, biochemical and biological differences. Within subgroups, serotypes are differentiated by the reactivity of the two major capsid proteins, hexon and fibre. Within each subgroup DNA sequence homology is greater than 85%. Adenoviruses associated with gastroenteritis are classified as subgroup F, serotypes 40 and 41.

Replication

All adenoviruses grow well in human epithelial cells, with the exception of the enteric adenoviruses types 40 and 41. Those can be grown in Graham 293 cells (a human embryonic kidney cell line transformed by adenovirus type 5 DNA; Takiff *et al.*, 1981). Replication has been studied in detail, mainly with adenoviruses types 2 and 5 of subgroup C. Cell attachment is facilitated by the fibre protein, and uptake is via receptor-mediated endocytosis, followed by uncoating, movement of viral DNA to the nucleus and phased early and late gene expression. The early protein E1A is a potent blocker for apoptosis and interferon (IFN)- α and - β expression. Late gene expression is at the onset of viral DNA replication and is accompanied by blockage of cellular and RNA expression. Virus assembly is in the cytoplasm. Virus particle release is after cell death, mediated by disruption of the cytoskeleton. Some adenovirus proteins seem to decrease expression of MHC class I antigens on the surface of infected cells, thus hindering susceptibility to adenovirus-specific cytotoxic T lymphocytes, and also to counteract tumour necrosis factor α expression (for details see Shenk, 1996).

Diagnosis

Detection of enteric adenoviruses in faecal specimens is mainly by ELISAs using subgroup F-specific monoclonal antibodies. Electron microscopy followed by immune electron microscopy (IEM) can also be used to identify these agents. Adenoviruses are detected in 4–15% of stools from children with

gastroenteritis in many hospitals, outpatients clinics and daycare centres (Krajden *et al.*, 1990). Thus, they are the second most common cause of infantile diarrhoea in temperate climates. However, of all the adenoviruses detected in faeces, only 30–50% belong to subgroup F, comprising types 40 and 41 (Krajden *et al.*, 1990; Lew *et al.*, 1991), the others being mainly members of subgroups B and D infecting primarily the respiratory tract. By the age of 3 years, 30–100% of children possess neutralizing antibodies to adenoviruses types 40 and 41, suggesting that there are likely to be many inapparent infections.

Clinical Symptoms and Treatment

Clinically, adenovirus-associated diarrhoea does not differ from those caused by other viruses, although the duration of symptoms may last slightly longer (3–11 days). The stools are watery and non bloody (in contrast to bacterial diarrhoeas). Fever and vomiting are common. Usually adenovirus gastroenteritis is a mild disease, and treatment is symptomatic.

Prevention and Control

At present there is no vaccine candidate for enteric adenoviruses. Control of hospital outbreaks is by cohort nursing of patients, use of gloves, gowns and goggles, and disinfection with sodium hypochlorite.

SMALL ROUND STRUCTURED VIRUSES (SRSVs)

Structure and Genome

This group of viruses was first recognized from an outbreak of gastroenteritis in an elementary school in Norwalk, Ohio, USA in 1968, affecting half of the students and teachers (for review see Cubitt, 1994; Kapikian *et al.*, 1996). The outbreak was not due to a bacterial pathogen, and, finally, using IEM, the causative agent *Norwalk virus* (NV) was visualized as a 27–35 nm virus particle. Upon cloning and sequencing of the genome, NV has been classified unequivocally as a member of the *Caliciviridae* fam-

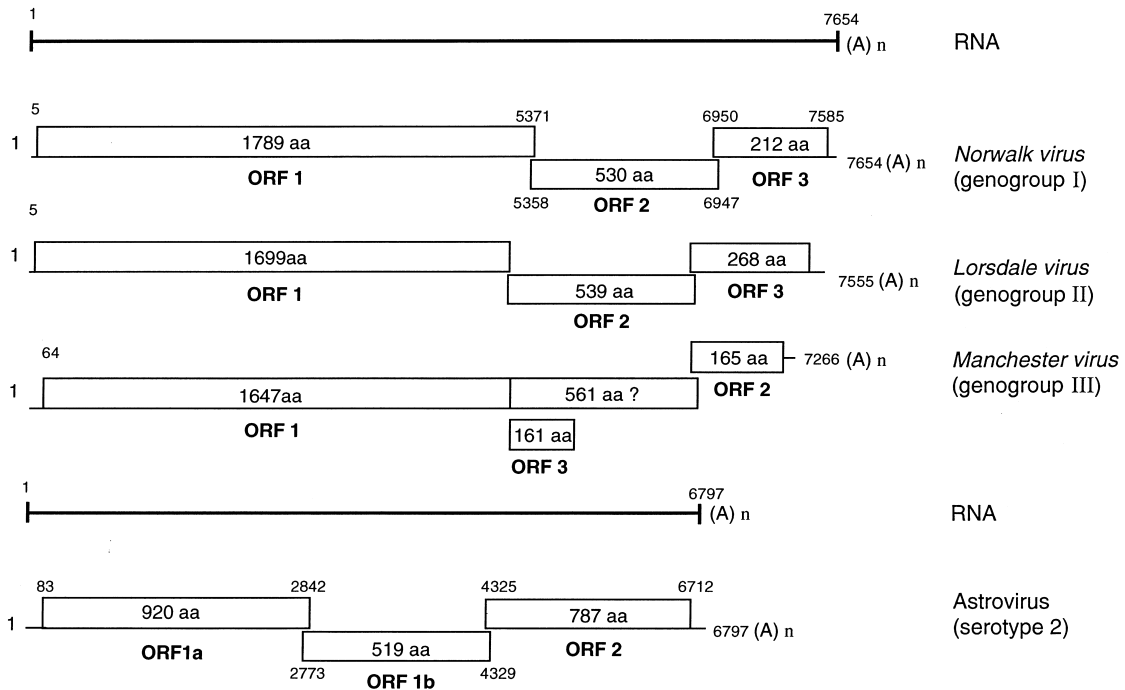

Figure 4.4 Genomic organization of Norwalk virus (NV; genogroup I), caliciviruses of genogroups II and III, and of astrovirus (serotype 2). For nomenclature of NV-like viruses see Table 4.3. ORF = open reading frame; aa = amino acids; (A)_n = poly(A) tail of RNA. (From Estes *et al.* (1997) and Matsui and Greenberg (1996); slightly modified)

ily. The genome consists of single-stranded RNA of positive polarity and approximately 7.7 kb in size. Typically, the surface of the particle carries cup-shaped depressions which have given the name to this viral family (Latin *calix* = goblet, cup).

The morphology of SRSVs has been analysed in more detail using cryoelectron microscopy and image reconstruction, when it was possible to produce recombinants and NV-like particles from insect cells which were infected with a baculovirus recombinant expressing the capsid protein (Prasad *et al.*, 1994a, 1994b). The capsid consists of 90 dimers of a single capsid protein of 58K molecular weight (monomer) which are arranged in such a way that large hollows are seen at the fivefold and threefold axes and represent what appears to be the cup-like structures in typical caliciviruses.

Full-length sequences of cDNAs from three different caliciviruses (NV, *Southampton virus* and *Manchester virus*) have now been obtained (Jiang *et al.*, 1993; Lambden *et al.*, 1993; Liu *et al.*, 1995). The single-stranded RNAs of positive polarity are polyadenylated and have a length of between 7.3 and

7.7 kb (Figure 4.4). The genome composition of the so-called 'classical' caliciviruses bears a greater similarity to that of several animal caliciviruses/SRSVs than to human SRSVs (Matson *et al.*, 1995; Liu *et al.*, 1995), justifying their classification as a separate subgenus. All calicivirus genomes have three open reading frames (ORFs), ORF 1 encoding non structural proteins with helicase, protease and RNA polymerase functions; ORF 2 the viral capsid protein; and ORF 3 at the 3' end of the genome encoding a small protein of as yet unknown function (Figure 4.4). As present, human SRSVs cannot be grown in cell culture.

Classification

Classification according to morphology differentiates between well-structured and featureless small round viruses; the SRSVs comprise NV and Norwalk-like viruses (diameter 27–35 nm; Hawaii, Snow Mountain, Mexico, Lorsdale, Sapporo, etc.

Table 4.3 Genogroups of human SRSVs

Virus	Name derived from morphology	Calicivirus genogroup
<i>Norwalk virus</i>	SRSV	I
<i>Southampton virus</i>	SRSV	I
<i>Desert Shield virus</i>	SRSV	I
Hawaii agent	SRSV	II
Snow Mountain agent	SRSV	II
<i>Mexico virus</i>	HuCV/MX	II
<i>Lordsdale virus</i>	HuCV/LV	II
Hu CV UK1–UK4	HuCV/UK1–UK4	II and untyped
<i>Toronto virus</i>	Minireovirus	II
<i>Sapporo virus</i>	HuCV Sapporo	III
	(HuCV Japan)	
<i>Manchester virus</i>	HuCV/MV	III
<i>Plymouth virus</i>	HuCV/PV	III

HuCV = human calicivirus;

SRSV = small round structured virus

Modified from Estes *et al.* (1997).

viruses), so-called classical caliciviruses (diameter 30–40 nm) and astroviruses (diameter 28–30 nm) (Estes *et al.*, 1997). Among the featureless small round viruses (SRVs), picornaviruses (diameter 27 nm) and parvoviruses (diameter 18–20 nm) are subsumed.

Using IEM and ELISAs it was discovered that at least five serotypes of SRSVs/caliciviruses exist, represented by NV, *Hawaii virus* (HV), Snow Mountain agent (SMA), Taunton agent (TA) and *Sapporo virus* (SV), respectively. Sequencing of corresponding regions of the genomes of a number of SRSVs (e.g. Wang *et al.*, 1994) has allowed three different genogroups to be distinguished. Within the genogroup, similarity is 92–99% for the polymerase region and 78–98% for the capsid region (Estes *et al.*, 1997; Table 4.3).

Replication

As there is no *in vitro* cell culture system available for human SRSVs, their replication can at present be deduced only from that of animal caliciviruses which have a similar genome organization and can be propagated in cell cultures. From this it appears that viruses interact with species-specific receptors. Proteins deduced from ORF 1 may arise from appropriate co- and post-translational cleavage of a polyprotein precursor, in a way similar to the cleavage cascade identified for picornaviruses (Pallansch

et al., 1984; for further details see Estes *et al.*, 1997).

Clinical Course

The incubation period ranges from 10 to 50 hours, and diarrhoea lasts 24–48 hours. Ileum biopsies from ill volunteers showed that a symptomatic illness correlated with blunting of intestinal villi, crypt hyperplasia, cytoplasmic vacuolization and lymphocytic infiltration of the lamina propria. Small intestinal brush border enzymes are decreased, and malabsorption and diarrhoea with abdominal cramps, nausea and vomiting result.

Laboratory Diagnosis

This is mainly by direct electron microscopy or IEM, by ELISA (Herrmann *et al.*, 1995) or, more recently, by RT-PCR assays (Ando *et al.*, 1994, 1995; Moe *et al.*, 1994). For the latter to be successful, broadly reactive primers must be available in order to detect most of the human SRSVs. Initial use of such primers looks promising (Green *et al.*, 1995). Alternatively, several sets of primers directed against the same or different regions of distinct genogroups can be used. These techniques have also been applied to detecting SRSVs in shellfish and other foodstuffs (Lees *et al.*, 1995; Atmar *et al.*, 1996) from which human infection frequently originate.

Immune Responses

The immune responses against SRSV infections have been examined in adult volunteer studies, using IEM and more recently ELISAs with recombinant antigens. However, there is the problem that most volunteers have been infected with such viruses some time before experimental exposure, and proper neutralization assays are not available. Interestingly, more than 50% of adult volunteers appear to be susceptible (Parrino *et al.*, 1977; Johnson *et al.*, 1990; Graham *et al.*, 1994; Gray *et al.*, 1994).

Volunteer studies have shown that pre-existing SRSV-reactive antibodies do not protect from reinfection in the longer run; on the contrary, higher pre-existing antibody levels seem to condition for more severe illness upon reinfection (Parrino *et al.*,

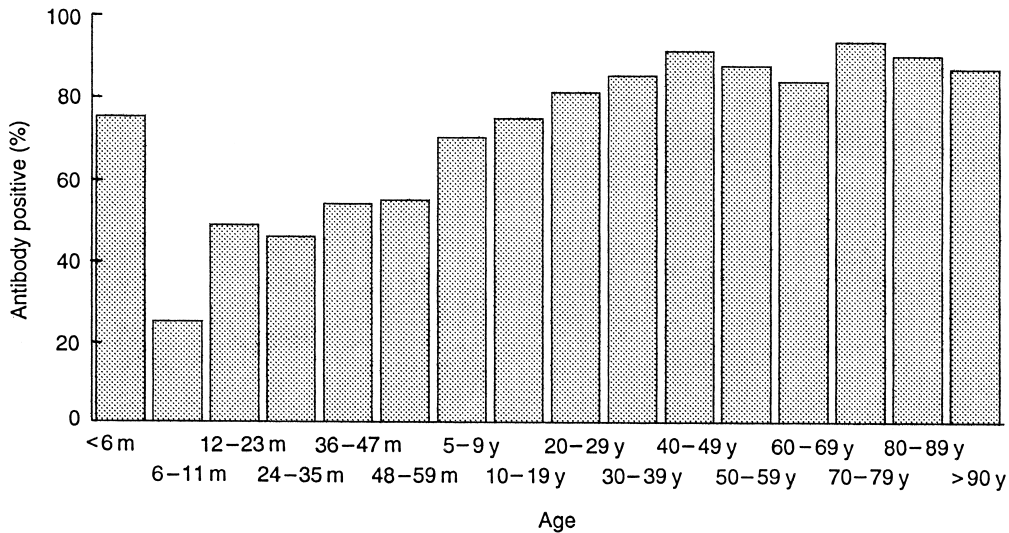

Figure 4.5 Age-related prevalence of antibodies to *Norwalk virus* in England. (From data of Gray *et al.*, 1993.)

1977; Gray *et al.*, 1994). On the other hand, some volunteers who fall ill after initial NV challenge remained immune when rechallenged 6–14 weeks later (Parrino *et al.*, 1977).

Clinical Course

The clinical symptoms were studied in 50 volunteers and were as follows: 41 (82%) became infected, of those 68% were symptomatic and 32% asymptomatic. Most common symptoms were nausea, headache and abdominal cramps followed by diarrhoea and vomiting. Severe symptoms lasted for only 12–48 hours (Graham *et al.*, 1994). Persistent infection with SRSVs and other viruses and chronic diarrhoea has been found in children with severe combined immunodeficiency (SCID) (Chrystie *et al.*, 1982) and in patients with the acquired immune deficiency syndrome (AIDS) (Grohmann *et al.*, 1993).

Epidemiology

The availability of recombinant proteins expressed from cloned cDNAs has allowed the study of age-dependent antibody prevalence in both developed and developing countries. Epidemic gastroenteritis produced by SRSVs is relatively mild. There is like-

ly to be a large number of inapparent infections in early childhood as it has been shown that 50% of 3-year-old children already have NV-specific antibodies, a number that increases to 80% in early adulthood (Figure 4.5; Gray *et al.*, 1993). In less-developed countries, NV-specific antibodies are produced after primary infection even earlier in life. In general, children appear to be infected with human SRSVs much more frequently than was recognized previously (Gray *et al.*, 1993; Numata *et al.*, 1994).

Outbreaks of acute gastroenteritis which can be related to food or waterborne sources, occur frequently in recreational camps, hospitals, schools, cruise ships, nursing homes, etc. and are associated with ingestion of contaminated drinking or recreational water, uncooked shellfish, eggs, salads and cold foods. Mixed infections with SRSVs of different genogroups have been observed (Gray *et al.*, 1997). Worldwide outbreaks occur year round, and nosocomial infection with SRSVs seems to be quite common. The viruses are highly infectious and spread rapidly in volunteer studies. The primary and secondary attack rates are high (above 50%). Transmission is by the faecal-oral route and by projectile vomiting producing an aerosol which scatters these viruses in the environment (Caul, 1994). Improvement of sanitary conditions and personal hygiene, as well as sometimes closure of facilities (hospitals, nurseries, etc.), are necessary to confine the infections. Viral shedding does not

normally persist beyond 100 hours after the initial infection, but can be prolonged for up to 2 weeks. Shedding has also been observed in volunteers who remained well.

Prevention

The most efficient methods of prevention are measures of good hygiene (handwashing, disinfection and disposal of contaminated faeces and material, hygienic processing of food, withdrawal from work of ill food handlers, etc.). A vaccine seems possible, for example derived from VLPs (Jiang *et al.*, 1992) and possibly from transgenic plants ('edible vaccines'; Mason *et al.*, 1996), but better understanding of the significance of antibody responses for protective immunity is required. Prophylactic surveillance of key personnel in hospitals or food production (including keeping people with vomiting and loose stools off work) and of water sources helps to reduce SRSV-induced outbreaks.

ASTROVIRUSES

Astroviruses are members of the newly defined family *Astroviridae* (Monroe *et al.*, 1993; Murphy *et al.*, 1995). Virions possess a genome of single-stranded RNA of positive polarity and no envelope, like the *Picornaviridae* and *Caliciviridae* (Matsui and Greenberg, 1996).

Structure and Genome

Morphologically astroviruses are 28–30 nm particles with typical five- or six-pointed star patterns on their surface, and sometimes also knob-like structures.

The astrovirus genome (Figure 4.4) of approximately 6.8 kb comprises three ORFs (1a, 1b and 2), coding for a viral protease (ORF 1a), an RNA-dependent RNA polymerase (ORF 1b) and structural proteins (ORF 2) (Willcocks *et al.*, 1994). There is a 70 base overlap in ORFs 1a and 1b containing sequences directing ribosomal frameshifting (to a -1 frame) for the reading of ORF 1b (Lewis and Matsui, 1994, 1996; Marczinke *et al.*, 1994).

Table 4.4 Incidence of astrovirus serotypes in Oxford, UK, 1976–1992, and prevalence of astrovirus type-specific antibodies in Utrecht, the Netherlands, 1994

Astrovirus type	Astrovirus isolates Oxford, UK ^a (n = 291) (% type)	Astrovirus antibody Utrecht, The Netherlands ^b (n = 260) (% type-specific antibody)
1	64.9	91
2	11.3	31
3	9.3	69
4	11.3	56
5	2.1	36
6	0.3	16
7	0.7	10

^aFrom Lee and Kurtz (1994).

^bFrom Koopmans *et al.* (1997a).

Classification

So far, seven serotypes have been distinguished by solid phase IEM and have been confirmed recently as different genotypes (Noel *et al.*, 1995). The incidence of different serotypes was determined from a collection of isolates in Oxford, UK (Lee and Kurtz, 1994) and has been complemented recently by an age-stratified study of the prevalence of neutralizing antibodies in Utrecht, The Netherlands (Koopmans *et al.* 1997; Table 4.4). According to this, serotype 1 is most frequently found, followed by serotypes 2–4 at medium and serotypes 5–7 at the least frequency. Interestingly, the seroprevalence figures suggest that individuals can become infected by more than one serotype.

Replication

Astroviruses grow well in some cell cultures (human embryonic kidney, monkey kidney or human colon carcinoma cells) in the presence of trypsin (Lee and Kurtz, 1981). After adsorption to and uncoating in cells (a receptor has so far not been identified), astroviruses produce full-length and subgenomic RNAs, the latter directing the production of the ORF 2 protein precursor. As mentioned above, the viral RNA polymerase is made from ORF 1b by ribosomal frameshifting (efficiency approximately 5%).

Pathogenesis

This is mainly deduced from studies of *in vitro* infected cells and of experimental animals. Adsorption occurs through a cellular receptor likely to contain sialic acid, and replication takes place in the cytoplasm. Animals infected with species-specific astroviruses (lambs, calves) show infection of mature enterocytes (at the tip of the villi) of the small intestine at 14–38 h post infection, and diarrhoea is observed on days 2–4.

Clinical Course, Diagnosis, Treatment and Prevention

Clinically, astrovirus infection is similar to that caused by rotaviruses, although often milder.

Diagnosis is by electron microscopy, IEM (typing), astrovirus-specific ELISA (detecting all seven types; Herrmann *et al.*, 1990) and generic and type-specific RT-PCR (Noel *et al.*, 1995).

Treatment is symptomatic, and prevention in outbreaks consists of measures to interrupt person-to-person spread (good hygiene, disinfection, surveillance of food sources, etc.). At present, there is no specific antiviral treatment no vaccine.

Epidemiology

Astroviruses are found in humans, lambs, calves, deer, piglets, mice, dogs and ducks, causing diarrhoea in most cases except for ducks, in which they cause acute hepatitis. Astroviruses are very species specific. Human astrovirus infections are seen in infants and the elderly as endemic infections and occasionally as the cause of food-borne outbreaks of diarrhoea. Their incidence in hospital-based studies has mostly been $\leq 5\%$ of viral causes of diarrhoea, but much higher incidence figures ($> 10\%$) were recorded in Guatemala and Thailand. A high percentage (15%) of cases of diarrhoea in HIV-infected individuals is due to astrovirus infection (Grohmann *et al.*, 1993). The seasonal incidence peak is in the winter. Transmission is via the faecal-oral route, person-to-person contact and possibly fomites. Large food-borne outbreaks of astrovirus gastroenteritis have been recorded (Matsui *et al.*, 1994; Oishi *et al.*, 1994; Utagawa *et al.*, 1994;

Mitchell *et al.*, 1995).

Astrovirus infection is frequent in childhood (often inapparent), and 75% of 10-year-old children have astrovirus antibodies.

GASTROINTESTINAL VIRUSES NOT REGULARLY ASSOCIATED WITH ACUTE DIARRHOEAL DISEASE

Details of the virology, immunology, diagnosis, clinical symptoms and epidemiology of these viruses are found in other chapters.

Enteroviruses

Enteroviruses (polioviruses, coxsackieviruses and echoviruses – all comprising a genus of the *Picornaviridae*) infect humans via the alimentary tract, where they have their first site of replication, probably in lymphoid tissues of the pharynx and the gut. Virus is usually excreted in the stool for several to many weeks and can also be isolated with ease from the pharynx during the first 2 weeks of infection. Most infections are asymptomatic. The main targets of disease are the central nervous system (spinal cord, brain, meninges), heart (myocardium and pericardium), skeletal muscles and skin, which are reached after a viraemic step originating from the gut (Melnick, 1996).

Diarrhoea is not a regular symptom of primary infection. Some echoviruses (notably types 4, 11, 14, 18, 19 and 22) as well as *Coxsackie virus A1* have been documented in outbreaks of diarrhoea (Townsend *et al.*, 1982; Patel *et al.*, 1985; Melnick, 1996), but a consistent association has not been established.

Reoviruses

Reoviruses, another genus of the *Reoviridae* family, also primarily infect the gut via M cells and have their first round of replication in the Peyer's patches. From there they are carried in a viraemic step (or by retrograde transport along the autonomic nerves) to the central nervous system, where they have their main disease targets in neuronal or ependymal cells. Reovirus pathogenesis has been

studied in detail in mice, and particular pathogenetic factors been associated with particular gene products (Tyler and Fields, 1996).

At the end of human childhood, antibodies against all three serotypes of reovirus are found, suggesting past infection. No firm association of reovirus infection with any distinct human disease has so far been established, although reoviruses are not infrequently seen in the gut; an association with mild diarrhoea has been suggested (Tyler and Fields, 1996).

Coronaviruses and Toroviruses

These two genera of the *Coronaviridae* cause respiratory and gastrointestinal infections in humans. Coronaviruses are a recognized major cause of the common cold and were found to be associated with cases of neonatal diarrhoea and of more severe necrotizing enterocolitis (Chang *et al.*, 1982; Vaucher *et al.* 1982; Gerna *et al.*, 1985), but coronavirus-like particles were also seen in symptomless healthy subjects (Marshall *et al.*, 1989).

Toroviruses, a well-established cause of diarrhoea in horses (Koopmans and Horzinek, 1994), were recently found to be associated with acute and possibly persistent diarrhoea in children (Koopmans *et al.*, 1997).

Parvoviruses

These viruses are well-known pathogens of diarrhoea in animals. However, in humans no firm association with diarrhoea has been made, although parvovirus-like particles are not infrequently observed as 'small round viruses' in human faeces.

Human Immunodeficiency Virus

The clinical virology of this member of the *Retroviridae* family (subfamily *Lentivirinae*) is extensively discussed elsewhere in this book. Here it should be mentioned that there is evidence for primary HIV infection in gut-associated lymphoid tissue and in enterocytes, which may contribute to an enteropathy with chronic diarrhoea in AIDS patients (Levinson and Bennets, 1985; Nelson *et al.*, 1988;

Heise *et al.*, 1991; Kotler *et al.*, 1991; Rabeneck, 1994).

Cytomegalovirus and Herpes Simplex Virus

These two members of the *Herpesviridae* family are frequent co-infectants/superinfectants of the gut of HIV-infected individuals causing mainly chronic colitis (Levinson and Bennets, 1985), but also oesophagitis, gastritis and cholangitis. There may be interaction between HIV and cytomegalovirus infections in causing gut disease (Skolnik *et al.*, 1988).

Picobirnaviruses

This recently established family of *Birnaviridae* (Murphy *et al.*, 1995) consists of bisegmented RNA viruses of approximately 60 nm in diameter and icosahedral structure. They were found in the gut of rats, guinea-pigs, pigs and calves and to be associated with cases of diarrhoea, although not regularly. Recently, besides astroviruses, caliciviruses and adenoviruses, picobirnaviruses were found to be significantly associated with diarrhoea in AIDS patients in a case-control study (Grohmann *et al.*, 1993).

ACKNOWLEDGEMENTS

The author gratefully acknowledges fruitful discussions with Dr J. Gray (Cambridge) and Dr J. Kurtz (Oxford), and the secretarial support of Mrs Isabel Harvey and Mrs Lynne Bastow.

REFERENCES

- Advisory Committee on Immunization Practices (ACIP) (1999) Rotavirus vaccine for the prevention of rotavirus gastroenteritis among children. *Morbidity and Mortality Weekly Report*, **48**(RR-2), 1–22.
- Ando, T., Monroe, S.S., Gentsch, J.R. *et al.* (1995) Detection and differentiation of antigenically distinct small round-structured viruses (Norwalk-like viruses) by reverse transcription-PCR and Southern hybridization. *Journal of Clinical Microbiology*, **33**, 64–71.

- Ando, T., Mulders, M.N., Lewis, D.C. *et al.* (1994) Comparison of the polymerase region of small round structured virus strains previously classified in three serotypes by solid-phase immune electron microscopy. *Archives of Virology*, **135**, 217–226.
- Atmar, R.L., Neill, F.H., Woodley, C.M. *et al.* (1996) A collaborative evaluation of a method for the detection of Norwalk virus in shellfish tissue using the polymerase chain reaction. *Applied and Environmental Microbiology*, **62**, 254–258.
- Ball, J.M., Tian, P., Zeng, C.Q.Y. *et al.* (1996) Age dependent diarrhea induced by a rotaviral nonstructural glycoprotein. *Science*, **272**, 101–104.
- Beards, G.M., Desselberger, U. and Flewett, T.H. (1989) Temporal and geographical distribution of human rotavirus serotypes 1983–1988. *Journal of Clinical Microbiology*, **27**, 2827–2833.
- Bern, C. and Glass, R.C. (1994) Impact of diarrheal diseases worldwide. In *Viral Infections of the Gastrointestinal Tract* (ed. A.Z. Kapikian), 2nd edn, pp 1–26. Marcel Dekker, New York.
- Bern, C., Martinez, J., de Zoysa, I. *et al.* The magnitude of the global problem of diarrhoeal disease: a ten year update. *Bulletin of the World Health Organization*, **70**, 705–714.
- Bernstein, D.I., Glass, R.I., Rodgers, G. *et al.* (1995) Evaluation of rhesus rotavirus monovalent and tetravalent reassortant vaccines in US children. US Rotavirus Vaccine Evaluation Group. *JAMA*, **273**, 1191–1196.
- Bhan, M.K., Mahalanabis, D., Fontaine, O. *et al.* (1994) Clinical trials of improved oral rehydration salt formulations: a review. *Bulletin of the World Health Organization*, **72**, 945–955.
- Blacklow, N.R. and Greenberg, H.B. (1991) Viral gastroenteritis. *New England Journal of Medicine*, **325**, 252–264.
- Broome, R.L., Vo, P.T., Ward, R.L. *et al.* (1993) Murine rotavirus genes encoding outer capsid proteins VP4 and VP7 are not major determinants of host range restriction and virulence. *Journal of Virology*, **67**, 2448–2455.
- Burke, B. and Desselberger, U. (1996) Rotavirus pathogenicity. *Virology*, **218**, 299–305.
- Burns, J.W., Siadat-Pajouh, M., Krishnaney, A.A. *et al.* (1996) Protective effect of rotavirus VP6-specific IgA monoclonal antibodies that lack neutralizing activity. *Science*, **272**, 104–107.
- Caul, E.O. (1994) Small round structured viruses: airborne transmission and hospital control. *Lancet*, **343**, 1240–1242.
- Caul, E.O., Ashley, C.R., Darville, J.M. *et al.* (1990) Group C rotavirus associated with fatal enteritis in a family outbreak. *Journal of Medical Virology*, **30**, 201–205.
- Chang, C., Moscovici, O., Lebon, P. *et al.* (1982) Association of coronavirus infection with neonatal necrotizing enterocolitis. *Pediatrics*, **69**, 209–214.
- Chen, S.C., Fynan, E.F., Robinson, H.L. *et al.* (1997) Protective immunity induced by rotavirus DNA vaccines. *Vaccine*, **15**, 899–902.
- Chen, S.C., Jones, D.H., Fynan, E.F. *et al.* (1998) Protective immunity induced by oral immunization with a rotavirus DNA vaccine encapsulated in microparticles. *Journal of Virology*, **72**, 5757–5761.
- Chrystie, I.L., Booth, I.W., Kidd, A.H. *et al.* (1982) Multiple faecal virus excretion in immunodeficiency. *Lancet*, **i**, 282.
- Conner, M.E., Zarley, C.D., Hu, B. *et al.* (1996) Virus-like particles as a rotavirus subunit vaccine. *Journal of Infectious Diseases*, **174** (suppl. 1), S88–S92.
- Coulson, B.S., Grimwood, K., Hudson, I.L. *et al.* (1992) Role of antibody in clinical protection of children during reaction with rotavirus. *Journal of Clinical Microbiology*, **30**, 1678–1684.
- Cubitt, W.D. (1994) Caliciviruses. In *Viral Infections of the Gastrointestinal Tract* (ed. A.Z. Kapikian), pp 549–568. Marcel Dekker, New York.
- Desselberger, U. (1993) Towards rotavirus vaccines. *Reviews in Medical Virology*, **3**, 15–21.
- Desselberger, U. (1996) Genome rearrangements of rotaviruses. *Advances in Virus Research*, **46**, 69–95.
- Desselberger, U. (1998a) Reoviruses. In *Topley and Wilson's Microbiology and Microbial Infections*, Vol. I: *Virology* (eds L. Collier and B. Mahy), pp 537–550. Edward Arnold, London.
- Desselberger, U. (1998b) Viral gastroenteritis. *Current Opinion in Infectious Diseases*, **11**, 565–575.
- Desselberger, U. (1998c) Prospects for vaccines against rotaviruses. *Reviews in Medical Virology*, **8**, 43–52.
- Desselberger, U. (1999) Rotavirus infections: guidelines for treatment and prevention. *Drugs* (in press).
- Dharakul, T., Rott, L. and Greenberg, H.B. (1990) Recovery from chronic rotavirus infection in mice with severe combined immunodeficiency: virus clearance mediated by adoptive transfer of immune CD8 Sup + T lymphocytes. *Journal of Virology*, **64**, 4375–4382.
- Estes, M.K. (1996) Rotaviruses and their replication. In *Fields Virology* (eds B.N. Fields, D.M. Knipe, P.M. Howley *et al.*), pp 1625–1655. Lippincott–Raven, Philadelphia.
- Estes, M.K., Atmar, R.L. and Hardy, M.E. (1997) Norwalk and related diarrhea viruses. In *Clinical Virology* (eds D.D. Richman, R.J. Whitley and F.G. Hayden), pp 1073–1095. Churchill Livingstone, New York.
- Feng, N., Burns, J.W., Bracy, L. *et al.* (1994) Comparison of mucosal and systemic humoral immune responses and subsequent protection in mice orally inoculated with a homologous or a heterologous rotavirus. *Journal of Virology*, **68**, 7766–7773.
- Feng, N., Vo, P.T., Chung, D. *et al.* (1997) Heterotypic protection following oral immunization with live heterologous rotavirus in a mouse model. *Journal of Infectious Diseases*, **175**, 330–341.
- Figuerola-Quintanilla, D., Salazar-Lindo, E., Sack, R.B. *et al.* (1993) A controlled trial of bismuth subsalicylate in infants with acute watery diarrheal disease. *New England Journal of Medicine*, **328**, 1653–1658.
- Franco, M.A. and Greenberg, H.B. (1995) Role of B cells and cytotoxic T lymphocytes in clearance and immunity to rotavirus infection in mice. *Journal of Virology*, **69**, 7800–7806.
- Garbarg-Chenon, A., Bricout, F. and Nicolas, J.C. (1986) Serological characterization of human reassortant rotaviruses. *Journal of Virology*, **59**, 510–513.
- Gentsch, J.R., Glass, R.I., Woods, P. *et al.* (1992) Identification of group A rotavirus gene 4 types by polymerase chain reaction. *Journal of Clinical Microbiology*, **30**, 1365–1373.
- Gentsch, J.R., Woods, P.A., Ramachandran, M. *et al.* (1996) Review of G and P typing results from a global collection of rotavirus strains: implications for vaccine development. *Journal of Infectious Diseases*, **174** (suppl. 1), S30–S36.
- Gerna, G., Passarini, N., Battaglia, M. *et al.* (1985) Human enteric coronaviruses: antigenic relatedness to human coronavirus OC43 and possible etiologic role in viral gastroenteritis. *Journal of Infectious Diseases*, **151**, 796–803.
- Gilger, M.A., Matson, D.O., Conner, M.E. *et al.* (1992) Extraintestinal rotavirus infections in children with immunodeficiency.

- ciency. *Journal of Pediatrics*, **120**, 912–917.
- Gorziglia, M., Green, K., Nishikawa, K. *et al.* (1988) Sequence of the fourth gene of human rotaviruses recovered from asymptomatic or symptomatic infections. *Journal of Virology*, **62**, 2978–2984.
- Gouvea, V., Glass, R.I., Woods, P. *et al.* (1990) Polymerase chain reaction amplification and typing of rotavirus nucleic acid from stool specimens. *Journal of Clinical Microbiology*, **28**, 276–282.
- Graham, D.Y., Jiang, X., Tanaka, T. *et al.* (1994) Norwalk virus infection of volunteers: new insights based on improved assays. *Journal of Infectious Diseases*, **170**, 34–43.
- Gray, J.J., Cunliffe, C., Ball, J. *et al.* (1994) Detection of immunoglobulin M (IgM), IgA, and IgG Norwalk virus-specific antibodies by indirect enzyme-linked immunosorbent assay with baculovirus-expressed Norwalk virus capsid antigen in adult volunteers challenged with Norwalk virus. *Journal of Clinical Microbiology*, **32**, 3059–3063.
- Gray, J.J., Green, J., Cunliffe, C. *et al.* (1997) Mixed genogroup SRSV infections among a party of canoeists exposed to contaminated recreational water. *Journal of Medical Virology*, **52**, 425–429.
- Gray, J.J., Jiang, X., Morgan-Capner, P. *et al.* (1993) Prevalence of antibodies to Norwalk virus in England: detection by enzyme-linked immunosorbent assay using baculovirus-expressed Norwalk virus capsid antigen. *Journal of Clinical Microbiology*, **31**, 1022–1025.
- Green, J., Gallimore, C.I., Norcott, J.P. *et al.* (1995) Broadly reactive reverse transcriptase polymerase chain reaction in the diagnosis of SRSV-associated gastroenteritis. *Journal of Medical Virology*, **47**, 392–398.
- Green, K.Y. and Kapikian, A.Z. (1992) Identification of VP7 epitopes associated with protection against human rotavirus infection or shedding in volunteers. *Journal of Virology*, **66**, 548–553.
- Grohmann, G.S., Glass, R.I., Pereira, H.G. *et al.* (1993) Enteric viruses and diarrhea in HIV-infected patients. *New England Journal of Medicine*, **329**, 14–20.
- Guarino, A., Canani, R.B., Russo, S. *et al.* (1994) Oral immunoglobulins for treatment of acute rotaviral gastroenteritis. *Pediatrics*, **93**, 12–16.
- Hart, C.A. and Cunliffe, N.A. (1997) Viral gastroenteritis. *Current Opinion in Infectious Diseases*, **10**, 408–413.
- Hedberg, C.W. and Osterholm, M.T. (1993) Outbreaks of foodborne and waterborne viral gastroenteritis. *Clinical Microbiology Reviews*, **6**, 199–210.
- Heise, C., Daudekar, S., Kumar, P. *et al.* (1991) Human immunodeficiency virus infection of enterocytes and mononuclear cells in human jejunal mucosa. *Gastroenterology*, **100**, 1521–1527.
- Herrmann, J.E., Blacklow, N.R., Matsui, S.M. *et al.* (1995) Monoclonal antibodies for detection of Norwalk virus antigen in stools. *Journal of Clinical Microbiology*, **33**, 2511–2513.
- Herrmann, J.E., Chen, S.C., Fynan, E.F. *et al.* (1996) Protection against rotavirus infections by DNA vaccination. *Journal of Infectious Diseases*, **174** (suppl. 1), S93–S97.
- Herrmann, J.E., Nowak, N.A., Perron-Henry, D.M. *et al.* (1990) Diagnosis of astrovirus gastroenteritis by antigen detection with monoclonal antibodies. *Journal of Infectious Diseases*, **161**, 226–229.
- Hoshino, Y., Saif, L., Kang, S.Y. *et al.* (1995) Identification of group A rotavirus genes associated with virulence of a porcine rotavirus and host range restriction of a human rotavirus in the gnotobiotic piglet model. *Virology*, **209**, 274–280.
- Hung, T. (1988) Rotavirus and adult diarrhoea. *Advances in Virus Research*, **35**, 193–218.
- Jiang, B., Dennehy, P.H., Spangenberg, S. *et al.* (1995) First detection of group C rotavirus in faecal specimens of children with diarrhea in the United States. *Journal of Infectious Diseases*, **172**, 45–50.
- Jiang, X., Wang, M., Graham, D.Y. *et al.* (1992) Expression, self-assembly, and antigenicity of the Norwalk virus capsid protein. *Journal of Virology*, **66**, 6527–6532.
- Jiang, X., Wang, M., Wang, K. *et al.* (1993) Sequence and genomic organization of Norwalk virus. *Virology*, **195**, 51–61.
- Joensuu, J., Koskeniemi, E., Pang, X.L. *et al.* (1997) Randomized placebo controlled trial of rhesus-human reassortant rotavirus vaccine for prevention of severe rotavirus gastroenteritis. *Lancet*, **350**, 1205–1209.
- Johnson, P.C., Mathewson, J.J., Dupont, H.L. *et al.* (1990) Multiple challenge study of host susceptibility to Norwalk gastroenteritis in US adults. *Journal of Infectious Diseases*, **161**, 18–21.
- Kanfer, E.J., Abrahamson, G., Taylor, J. *et al.* (1994) Severe rotavirus associated diarrhoea following bone marrow transplantation: treatment with oral immunoglobulin. *Bone Marrow Transplantation*, **14**, 651–652.
- Kapikian, A.Z. (1994) Jennerian and modified Jennerian approach to vaccination against rotavirus diarrhea in infants and young children: an introduction. In *Viral Infections of the Gastrointestinal Tract*, (ed. A.Z. Kapikian) 2nd edn, pp 409–517. Marcel Dekker, New York.
- Kapikian, A.Z., Estes, M.K. and Chanock, R.M. (1996) Norwalk group of viruses. In *Fields Virology* (eds B.N. Fields, D.M. Knipe, P.M. Howley *et al.*), pp 783–810. Lippincott-Raven, Philadelphia.
- Koopmans, M.P.G., Bijen, M.H.L., Monroe, S.S. *et al.* (1997a) Astrovirus type-specific antibody prevalence in Utrecht, The Netherlands. *American Society for Virology, 16th Annual Meeting*, Bozeman/Montana. Abstracts, W35/1, p. 158.
- Koopmans, M.P., Goosen, E.S., Lima, A.A. *et al.* (1997b) Association of torovirus with acute and persistent diarrhea in children. *Pediatric Infectious Disease Journal*, **16**, 504–507.
- Koopmans, M. and Horzinek, M. (1994) Toroviruses of animal and humans: a review. *Advances in Virus Research*, **43**, 233–273.
- Kotler, D.P., Reka, S.A., Borcich, A. *et al.* (1991) Detection, localization and quantitation of HIV-associated antigens in intestinal biopsies from patients with AIDS. *American Journal of Pathology*, **139**, 823–830.
- Krajden, M., Brown, M., Petrusek, A. *et al.* (1990) Clinical features of adenovirus enteritis: a review of 127 cases. *Pediatric Infectious Disease Journal*, **9**, 636–641.
- Lambden, P.R., Caul, E.O., Ashley, C.R. *et al.* (1993) Sequence and genome organization of a human small round-structured (Norwalk-like) virus. *Science*, **259**, 516–518.
- Lawton, J.A., Estes, M.K. and Prasad, B.V. (1997a) Three-dimensional visualization of mRNA release from actively transcribing rotavirus particles. *Nature Structural Biology*, **4**, 118–121.
- Lawton, J.A., Zeng, C.Q., Mukherjee, S.K. *et al.* (1997b) Three-dimensional structural analysis of recombinant rotavirus-like particles with intact and amino-terminal-deleted VP2: impli-

- cations for the architecture of VP2 capsid layer. *Journal of Virology*, **71**, 7353–7369.
- Lee, T. and Kurtz, J.B. (1981) Serial propagation of astrovirus in tissue culture with the aid of trypsin. *Journal of General Virology*, **57**, 421–424.
- Lee, T.W. and Kurtz, J.B. (1994) Prevalence of astrovirus serotypes in the Oxford region 1976–92, with evidence for 2 new serotypes. *Epidemiology and Infection*, **112**, 187–193.
- Lees, D.N., Henshilwood, K., Green, J. *et al.* (1995) Detection of small round structured viruses in shellfish by reverse transcription-PCR. *Applied and Environmental Microbiology*, **61**, 4418–4424.
- Levinson, W. and Bennets, R.W. (1985) Cytomegalovirus colitis in acquired immunodeficiency: a chronic disease with varying manifestations. *American Journal of Gastroenterology*, **80**, 445–447.
- Lew, J.F., Moe, C.L., Monroe, S.S. *et al.* (1991) Astrovirus and adenovirus associated with diarrhoea in children in day care settings. *Journal of Infectious Diseases*, **164**, 673–678.
- Lewis, T.L. and Matsui, S.M. (1994) An astrovirus frameshift signal induces ribosomal frameshifting *in vitro*. *Archives of Virology*, **140**, 1127–1135.
- Lewis, T.L. and Matsui, S.M. (1996) Astrovirus ribosomal frameshifting in an infection-transfection transient expression system. *Journal of Virology*, **70**, 2869–2875.
- Liu, B.L., Clarke, I.N., Caul, E.O. *et al.* (1995) Human enteric caliciviruses have a unique genome structure and are distinct from the Norwalk-like viruses. *Archives of Virology*, **140**, 1345–1356.
- Ludert, J.E., Feng, N., Yu, H. *et al.* (1996) Genetic mapping indicates that VP4 is the rotavirus cell-attachment protein *in vitro* and *in vivo*. *Journal of Virology*, **70**, 487–493.
- Marczinke, B., Bloys, A.J., Brown, T.D.K. *et al.* (1994) The human astrovirus RNA-dependent RNA polymerase coding region is expressed by ribosomal frameshifting. *Journal of Virology*, **68**, 5588–5595.
- Marshall, J.A., Thompson, W.L. and Gust, I.D. (1989) Coronavirus-like particles in adults in Melbourne, Australia. *Journal of Medical Virology*, **29**, 238–243.
- Mason, H.S., Ball, J.M., Shi, J.J. *et al.* (1996) Expression of Norwalk virus capsid protein in transgenic tobacco and potato and its immunogenicity in mice. *Proceedings of the National Academy of Sciences of the USA*, **93**, 5335–5340.
- Matson, D.O., Zhong, W., Nakata, S. *et al.* (1995) Molecular characterization of a human calicivirus with closer sequence relatedness to animal caliciviruses than other known human caliciviruses. *Journal of Medical Virology*, **45**, 215–222.
- Matsui, S.M. and Greenberg, H.B. (1996) Astroviruses. In *Fields Virology*, 3rd edn (eds B.N. Fields, D.M. Knipe, P.M. Howley *et al.*), pp 811–824. Lippincott-Raven, Philadelphia.
- Matsui, S.M., Lewis, T.L., Chiu, E. *et al.* (1994) An outbreak of astrovirus gastroenteritis in a nursing home and molecular characterization of the virus. *Gastroenterology*, **106**, A730.
- Matsumoto, K., Hatano, J., Kobayashi, K. *et al.* (1989) An outbreak of gastroenteritis associated with acute rotaviral infection in school children. *Journal of Infectious Diseases*, **160**, 611–615.
- Mattion, N.M., Cohen, J. and Estes, M.K. (1994) The rotavirus proteins. In *Viral Infections of the Gastrointestinal Tract*, 2nd edn, (ed. A.Z. Kapikian), pp 169–249. Marcel Dekker, New York.
- Melnick, J.L. (1996) Enteroviruses: polioviruses, coxsackieviruses, echoviruses, and newer enteroviruses. In *Fields Virology*, 3rd edn (eds B.N. Fields, D.M. Knipe, P.M. Howley *et al.*), pp 655–712. Lippincott-Raven, Philadelphia.
- Midthun, K. and Kapikian, A.Z. (1996) Rotavirus vaccines: an overview. *Clinical Microbiology Reviews*, **9**, 423–434.
- Mitchell, D.K., Monroe, S.S., Jiang, X. *et al.* (1995) Virologic features of an astrovirus diarrhea outbreak in a day care centre revealed by reverse transcription-polymerase chain reaction. *Journal of Infectious Diseases*, **172**, 1437–1444.
- Moe, C.L., Gentsch, J., Grohman, G. *et al.* (1994) Application of PCR to detect Norwalk virus in faecal specimens from outbreaks of gastroenteritis. *Journal of Clinical Microbiology*, **32**, 642–648.
- Monroe, S.S., Jiang, B., Stine, S.E. *et al.* (1993) Subgenomic RNA sequence of human astrovirus supports classification of *Astroviridae* as a new family of RNA viruses. *Journal of Virology*, **67**, 3611–3614.
- Murphy, F.A., Fauquet, C.M., Bishop, D.H.L. *et al.* (eds) (1995) *Virus Taxonomy. Classification and Nomenclature of Viruses*. Springer-Verlag, New York.
- Nelson, J.A., Reynolds-Kohler, C., Margaretten, W. *et al.* (1988) Human immunodeficiency virus detected in bowel epithelium from patients with gastrointestinal symptoms. *Lancet*, **i**, 259–262.
- Noel, J.S., Beards, G.M. and Cubitt, W.D. (1991) An epidemiological survey of human rotavirus serotypes and electrophoretotypes in young children admitted to two hospitals in North East London. *Journal of Clinical Microbiology*, **29**, 2213–2219.
- Noel, J.S., Lee, T.W., Kurtz, J.B. *et al.* (1995) Typing of human astroviruses from clinical isolates by enzyme immunoassay and nucleotide sequencing. *Journal of Clinical Microbiology*, **33**, 797–801.
- Numata, K., Nakata, S., Jiang, E. *et al.* (1994) Epidemiological study of Norwalk virus infections in Japan and Southeast Asia by enzyme-linked immunosorbent assays with Norwalk virus capsid protein produced by the baculovirus expression system. *Journal of Clinical Microbiology*, **32**, 121–126.
- Offit, P.A. (1994) Rotaviruses. Immunological determinants of protection against infection and disease. *Advances in Virus Research*, **44**, 161–202.
- Offit, P.A., Clark, H.F., Blavat, G. *et al.* (1986a) Reassortant rotaviruses containing structural proteins VP3 and VP7 from different parents induce antibodies protective against each parental serotype. *Journal of Virology*, **60**, 491–496.
- Offit, P.A., Khoury, C.A., Moser, C.A. *et al.* (1994) Enhancement of rotavirus immunogenicity by microencapsulation. *Virology*, **203**, 134–143.
- Offit, P.A., Shaw, R.D. and Greenberg, H.B. (1986b) Passive protection against rotavirus-induced diarrhea by monoclonal antibodies to surface proteins HVP3 and HVP7. *Journal of Virology*, **58**, 700–703.
- Oishi, I., Yamazaki, K., Kimoto, T. *et al.* (1994) A large outbreak of acute gastroenteritis associated with astrovirus among students and teachers in Osaka, Japan. *Journal of Infectious Diseases*, **170**, 439–443.
- Pallansch, M.A., Kew, O.M., Semler, B.L. *et al.* (1984) Protein processing map of poliovirus. *Journal of Virology*, **49**, 873–880.
- Parrino, T.A., Schreiber, T.S., Trier, J.S. *et al.* (1977) Clinical immunity in acute gastroenteritis caused by Norwalk agent.

- New England Journal of Medicine*, **297**, 86–89.
- Patel, J.R., Daniel, J. and Mathan, V.I. (1985) An epidemic of acute diarrhoea in rural Southern India associated with echovirus type 11 infection. *Journal of Hygiene* (Cambridge), **95**, 483–492.
- Perez-Schael, I., Guntiñas, M.J., Pérez, M. *et al.* (1997) Efficacy of the rhesus rotavirus-based quadrivalent vaccine in infants and young children in Venezuela. *New England Journal of Medicine*, **337**, 1181–1187.
- Phillips, A.D. (1989) Mechanisms of mucosal injury: human studies. In *Virus and the Gut* (ed. M.J.G. Farthing), pp 30–40. Swan Press, London.
- Prasad, B.V.V., Burns, J.W., Marietta, E. *et al.* (1990) Localization of VP4 neutralization sites in rotavirus by three-dimensional cryo-electron microscopy. *Nature*, **343**, 476–479.
- Prasad, B.V.V. and Estes, M.K. (1997) Molecular basis of rotavirus replication: structure–function correlations. In *Structural Biology of Viruses* (eds W. Chiu, R.M. Burnett and R.L. Garcia), pp 239–268. Oxford University Press, New York.
- Prasad, B.V.V., Matson, D.O. and Smith, A.J. (1994a) Three-dimensional structure of calicivirus. *Journal of Molecular Biology*, **240**, 256–264.
- Prasad, B.V.V., Rothnagel, R., Jiang, X. *et al.* (1994b) Three-dimensional structure of baculovirus-expressed Norwalk virus capsids. *Journal of Virology*, **68**, 5117–5125.
- Prasad, B.V.V., Rothnagel, K., Zeng, C.Q. *et al.* (1996) Visualization of ordered genomic RNA and localization of transcriptional complexes in rotaviruses. *Nature*, **382**, 471–473.
- Prasad, B.V.V., Wang, G.J., Clerx, J.P. *et al.* (1988) Three-dimensional structure of rotavirus. *Journal of Molecular Biology*, **199**, 269–275.
- Rabeneck, L. (1994) AIDS enteropathy: What's in a name? *Journal of Clinical Gastroenterology*, **19**, 154–157.
- Ramachandran, M., Gentsch, J.R., Parashar, U.D. *et al.* (1998) Detection and characterization of novel rotavirus strains in the United States. *Journal of Clinical Microbiology*, **36**, 3223–3229.
- Rennels, M.B., Glass, R.I., Dennehy, P.H. *et al.* (1996) Safety and efficacy of high-dose rhesus-human reassortant rotavirus vaccines—report of the multicenter trial US rotavirus vaccine efficacy group. *Pediatrics*, **97**, 7–13.
- Shaw, A.L., Rothnagel, R., Chen, D. *et al.* (1993) Three-dimensional visualization of the rotavirus haemagglutinin structure. *Cell*, **74**, 693–701.
- Shenk, T. (1996) Adenoviridae: The viruses and their replication. In *Fields Virology* (eds B.N. Fields, D.M. Knipe, P.M. Howley *et al.*), 3rd edn, pp 2111–2148. Lippincott-Raven, Philadelphia.
- Skolnik, P.R., Kosloff, B.R. and Hirsch, M.S. (1988) Bidirectional interactions between human immunodeficiency virus type 1 and cytomegalovirus. *Journal of Infectious Diseases*, **157**, 508–513.
- Stewart, P.L., Burnett, R.M., Cyrklaff, M. *et al.* (1991) Image reconstruction reveals the complex molecular nature of adenoviruses. *Cell*, **67**, 145–154.
- Takiff, H.F., Strauss, S.E. and Garon, C.F. (1981) Propagation and *in vitro* studies of previously non-cultivable enteric adenoviruses in 293 cells. *Lancet*, **ii**, 832–834.
- Tian, P., Estes, M.K., Hu, Y. *et al.* (1995) The rotavirus nonstructural glycoprotein NSP4 mobilizes Ca²⁺ from the endoplasmic reticulum. *Journal of Virology*, **69**, 5763–5772.
- Tian, P., Hu, Y., Schilling, W.P. *et al.* (1994) The nonstructural glycoprotein of rotavirus affects intracellular calcium levels. *Journal of Virology*, **68**, 251–257.
- Townsend, T.R., Bolyard, E.A., Yolken, R.H. *et al.* (1982) Outbreak of Coxsackie A1 gastroenteritis: a complication of bone marrow transplantation. *Lancet*, **i**, 820–823.
- Tyler, K.L. and Fields, B.N. (1996) Reoviruses. In *Fields Virology*, 3rd edn (eds B.N. Fields, D.M. Knipe, P.M. Howley *et al.*), pp 1597–1623. Lippincott-Raven, Philadelphia.
- Urasawa, S., Urasawa, T. and Taniguchi, K. (1986) Genetic reassortment between two human rotaviruses having different serotype and subgroup specificities. *Journal of General Virology*, **67**, 1551–1559.
- Utagawa, E.T., Nishizawa, S., Sekine, S. *et al.* (1994) Astrovirus as a cause of gastroenteritis in Japan. *Journal of Clinical Microbiology*, **32**, 1841–1845.
- Vaucher, Y.E., Ray, C.G., Minnich, L.L. *et al.* (1982) Pleomorphic enveloped virus-like particles associated with gastrointestinal illness in neonates. *Journal of Infectious Diseases*, **145**, 27–36.
- Velasquez, F.R., Matson, D.O., Calva, J.J. *et al.* (1996) Rotavirus infection in infants as protection against subsequent infection. *New England Journal of Medicine*, **355**, 1022–1028.
- Wang, J., Jiang, X., Madore, H.P. *et al.* (1994) Sequence diversity of small round structured viruses. *Journal of Virology*, **68**, 5982–5990.
- Willcocks, M.M., Brown, T.D.K., Madeley, C.R. *et al.* (1994) The complete sequence of a human astrovirus. *Journal of General Virology*, **75**, 1785–1788.
- Yeager, M., Berriman, J.A., Baker, T.S. *et al.* (1994) Three-dimensional structure of the rotavirus haemagglutinin VP4 by cryo-electron microscopy and difference map analysis. *EMBO Journal*, **13**, 1011–1018.
- Yeager, M., Dryden, K.A., Olson, N.H. *et al.* (1990) Three-dimensional structure of rhesus rotavirus by cryoelectron microscopy and image reconstruction. *Journal of Cell Biology*, **110**, 2133–2144.
- Yuan, L.Z., Ward, L.A., Rosen, B.I. (1996) Systemic and intestinal antibody secreting cell responses and correlates of protective immunity to human rotavirus in a gnotobiotic pig model of disease. *Journal of Virology*, **70**, 3075–3083.

Influenza

Chris W. Potter

University of Sheffield, Sheffield, UK

Introduction

Although occasionally occurring as sporadic infections, influenza is more commonly and dramatically seen as local outbreaks or widespread epidemics: these occur in most parts of the world, and in some countries in most years. Epidemics can arise at any time, but are usually concentrated in months of high relative humidity: they occur explosively, often with little or no warning; and the number of people infected can vary from a few hundred to hundreds of thousands. In addition, history records some 12 occasions since AD 1700 when influenza has caused pandemics, and at these times millions were infected. In many cases epidemics are short-lived, lasting days or weeks; however, those occurring in large groupings can occur in successive waves for months. It is the large numbers of persons infected during an outbreak of influenza, together with our proven inability to prevent or contain these outbreaks, which has focused so much study and research on this disease.

Influenza is a short-lived but relatively severe respiratory infection in healthy adults, and the large numbers of patients involved in an epidemic can include a significant number of deaths. Epidemics can be disruptive to industry, with loss of productivity, and to services such as medical, postal, power, police and education; can cause depressed immunity to other infectious agents; can cause depression and behavioural complications which may continue for months after the acute phase of disease has passed; and infection is life-threatening to the

elderly and to patients with predisposing heart and chronic chest disease. Epidemics can be traced anecdotally from the fourth century BC, the Hundred Years War and the court of Mary Tudor, to the more exact records of the last 100 years; nevertheless, knowledge gained during this latter period, including the past 60 years when the virus could be isolated and studied in the laboratory, has done little to prevent epidemics or help treat patients: it is not surprising, therefore, that influenza has been referred to as 'the last plague'.

Such has been the impact of epidemic influenza on communities that it is easy to understand the interest of researchers, physicians, diagnostic laboratories, health authorities and pharmaceutical companies in this infection, and the large investments of both time and money into the study of this disease. Thus, since the first isolation of an influenza virus in ferrets in 1933, research into the nature and control of this disease has led to the setting up of many research laboratories devoted to the study of influenza viruses, and to the commissioning of an international network of communicating laboratories by the World Health Organization to monitor the antigenic changes in the infecting viruses and the incidence and spread of infection. As a result of these activities, a large volume of information is available concerning influenza viruses: whether application of this knowledge can be ordered to diminish the impact of influenza on individuals or to prevent the epidemics and pandemics which will inevitably occur in the future remains to be seen (Stuart-Harris, 1979). Although many ques-

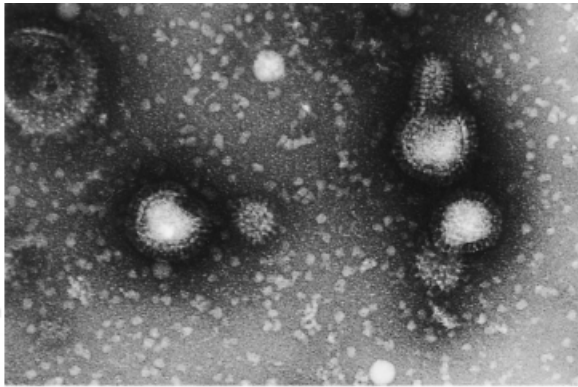

(a)

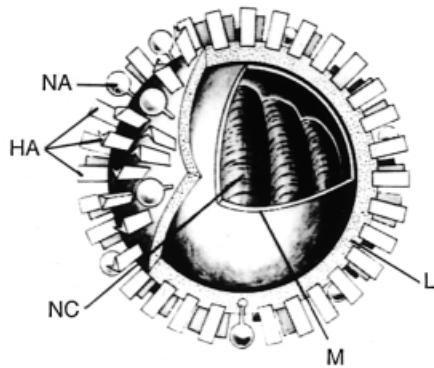

(b)

Figure 5.1 Structure of influenza virus particle: (a) electron microscopic appearance; (b) diagram of structural components. HA = haemagglutinin; L = lipid bilayer in which the HA and NA subunits are inserted; M = matrix protein; NA = neuraminidase; NC = nucleocapsid consisting of nucleoprotein (NP) subunits closely associated with the viral RNA. (Courtesy of Stuart-Harris and Schild, 1976)

tions concerning influenza and influenza viruses remain unanswered, much of the scientific information necessary to achieve the above aims is available; but an enormous number of resources are necessary for their implementation, and this must be considered in competition with other priorities.

THE VIRUSES

Structure

The influenza viruses belong to the genera *Influenza virus A*, *B* and *C* in the family *Orthomyxoviridae*.

Studies on the structure of influenza viruses carried out during the past years have brought knowledge of this subject to a point far in advance of that known for other viruses, with the exception of human immunodeficiency virus. Influenza viruses grown in embryonated eggs and examined in the electron microscope show particles approximately spherical and with a diameter of 80–120 nm: after serial passage in the laboratory, some strains produce filamentous particles, and pleomorphic forms are not uncommon (Stuart-Harris *et al.*, 1985). The electron microscopic appearance of influenza virus particles is shown in Figure 5.1a, and a diagram showing the components that make up the particles is shown in Figure 5.1b.

The chemical composition of the virus particles has been determined. Each particle is composed of approximately 1% RNA, 70–75% protein, 20–24% lipid and 5–8% carbohydrate. Structurally, the virus consists of a single strand of RNA of molecular weight $4-6 \times 10^6$ segmented into eight fragments; the molecular weight of the fragments ranges from 3×10^5 to 1×10^6 . The RNA is closely associated with the nucleoprotein (NP) to form a helical structure, the nucleocapsid; the NP has a molecular weight of approximately 60K, and there are approximately 1000 molecules in each virus particle. The NP is a type-specific antigen and occurs in one of three antigenic forms, and these different forms provide the basis for the classification of human influenza viruses into types A, B and C.

Surrounding the nucleocapsid is a second protein referred to as the matrix or membrane protein (M1); this protein is the major protein of the virus particle, occupying 35–45% of the particle mass. The molecular weight of the M1 protein is 23K, and there are approximately 3000 molecules in each virus particle. A second M protein, termed M2 and coded by the same gene segment, is important in virus replication (see below); there are 14–68 molecules of M2 present in each virus particle which are thought to have a function in virus assembly. About the M1 protein the particles have a viral membrane; this is a lipid bilayer which constitutes approximately 20–24% of the virus particle.

Two virus glycoproteins are inserted into the membrane; these are rod-shaped structures radiating out from the virus particles to give a spiky appearance to the surface. The first of these glycoproteins is the haemagglutinin (HA), which is composed of two separate molecules, termed HA1 and

HA2, joined together by a disulphide bond (Skehel *et al.*, 1984); the complete HA molecule is composed of three of these subunits, each of molecular weight 75–80K, and 20% carbohydrate to give a total molecular weight of approximately 225K. There are approximately 1000 HA molecules on each virus particle: each HA particle is 14–16 nm in length and 4 nm in diameter, and is attached to the lipid membrane by a hydrophobic tip; and the HA forms 25–30% of the protein of the virus. The subtype classification of influenza viruses is based principally on the different antigenic forms of the HA molecule. The function of the HA is the attachment of the virus to receptors on the surface of host cells during the initial stages of virus infection: the HA also attaches to receptors on erythrocytes, causing haemagglutination. The second glycoprotein radiating from the surface of the virus particle is the neuraminidase (NA). There are 100–200 NA molecules on the surface of each virus particle: they are 10 nm long and 4 nm in diameter; and are composed of four identical subunits, each of molecular weight approximately 60K and an unknown amount of carbohydrate. The NA molecules are attached to the viral membrane by a stalk terminated by a hydrophobic tip; the complete structure has a mushroom appearance (Laver *et al.*, 1984), and a total molecular weight of approximately 200–250K. Again, the NA glycoprotein is antigenically variable, and these differences are used in the classification of the viruses. The function of the NA is not fully understood: the enzyme hydrolyses sialic acid residues from specific glycoproteins, and can thus affect or modify cell receptors of absorption; alternatively, NA may mediate in the release of newly formed virus particles from the surface of infected cells. The NA does not appear to have a function in virus entry, replication or assembly (Liu *et al.*, 1995).

Influenza virus particles also contain three further non-glycosylated P-proteins; these are termed PB1, PB2 and PA: the molecular weights vary from 80 000 to 90 000K; there are approximately 50 molecules of each species in each virus particle; and they are internal components of the viral particles, probably associated with the nucleocapsid. The function of the P-proteins is not fully understood; however, these molecules are involved in virus-specific RNA synthesis associated with virus replication. Finally, the virus RNA codes for two non-structural proteins, termed NS1 and NS2: NS1 is synthesized

early after infection, while NS2 appears late and is found in virus particles (Richardson, 1991). The function of these molecules is unknown, but mutant viruses with defects in the RNA fragment coding for these proteins are unable to synthesize sufficient viral RNA or M1 protein.

Most studies on the structure of influenza virus particles have been carried out on influenza A viruses; however, sufficient work has been done with influenza B viruses to suggest general similarity in size, composition and structure. Some differences have been found, but the significance of these to virus behaviour and epidemiology is not known. The influenza B viruses differ from influenza A viruses by the presence of an antigenically distinct NP, and this, together with the antigenic specificity of other virus proteins and glycoproteins, characterizes a virus type with marked differences in epidemiological behaviour. The size, composition and structure of influenza C viruses are similar to those of influenza A: the main difference is an antigenically distinct NP, and the absence of the NA glycoprotein. These differences again characterize a virus which has epidemiological properties distinct from those of influenza viruses A and B.

Replication

Most studies on the replication of influenza viruses have been carried out using influenza A strains; and the limited number of studies with influenza B viruses have not indicated major differences in the mechanism of replication of this virus type. When *Influenza A virus* is inoculated on to cell cultures, three possible consequences may result. First, the virus may fail to initiate infection. Secondly, the virus may undergo an incomplete growth cycle, known as abortive infection; this occurs in a variety of cell lines, including HeLa cells, L cells and human diploid fibroblast cells. There is at present no accepted explanation for abortive infection, but because of a block at some stage of the normal replication cycle large numbers of virus particles are produced which are deficient in RNA content and are non-infective. Abortive infection is also seen when large amounts of virus are inoculated on to permissive cells, such as the cells of the amniotic membrane of the embryonated egg, where the effect is described as the Von Magnus phenomenon. Thirdly, infection

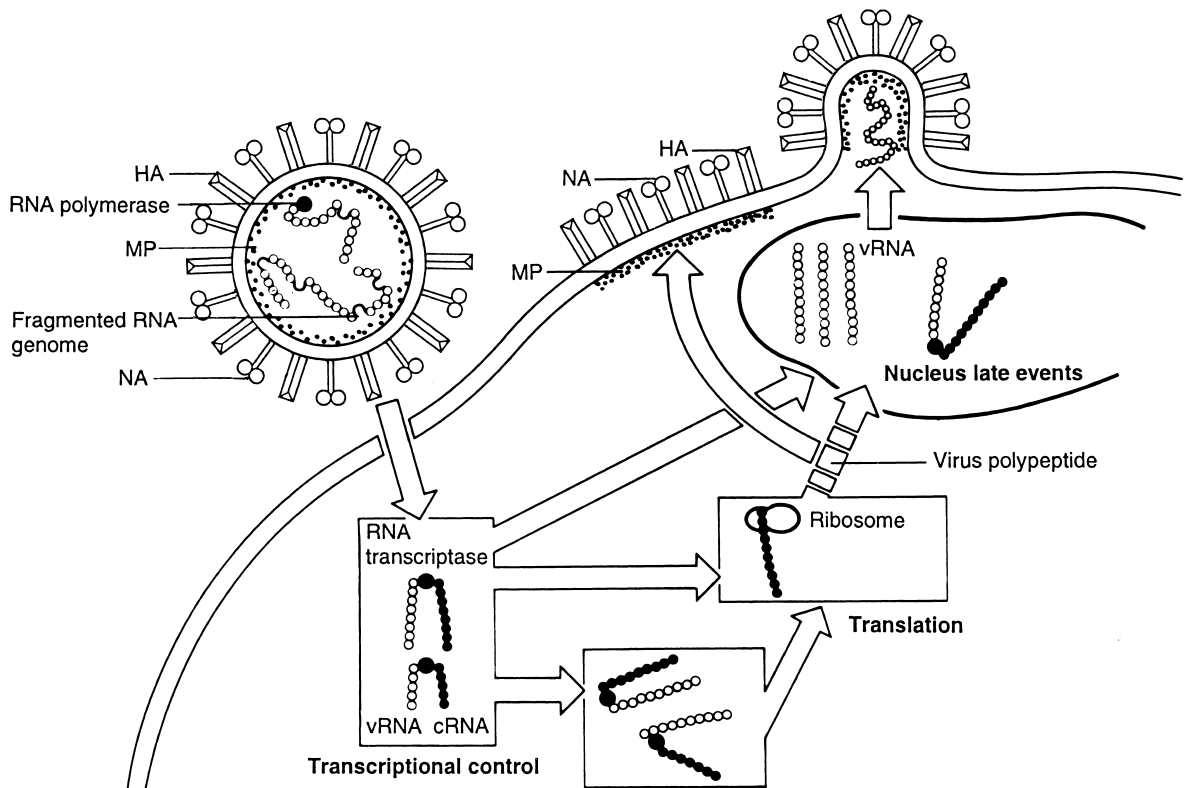

Figure 5.2 Model of replication of influenza virus. (Reproduced with permission from J.S. Oxford and the British Society of Antimicrobial Chemotherapy; *Journal of Antimicrobial Chemotherapy* (1975), 1, 7)

may be permissive, and result in the production of infective virus; the various stages of replication are shown in Figure 5.2.

Permissive infection by influenza virus occurs in human, baboon and monkey kidney cells and in the cells lining the amniotic and allantoic cavities of the embryonated hen's egg, and is initiated by absorption of virus to the cell surface. This phenomenon requires the interaction of two molecules: these are a virus receptor on the cell surface which is a neuraminic acid-containing glycoprotein; and the virus HA, since antibody against the HA prevents virus adsorption. Following adsorption, virus enters the cell: penetration is suggested by electron microscopic studies to be a pinocytotic process resulting in virus-containing endosomes appearing in the cell cytoplasm at approximately 20 minutes after virus infection. The subsequent stage of virus uncoating is not fully understood; however, it occurs as a result of fusion of virus particles with endosomal membranes, a fall in pH and the disruption

of the virus coat by lysosomal protease and lipase enzymes, and requires a proton channel formed by the M2 protein (Lamb *et al.*, 1994). The released virus genome (vRNA) together with the polymerase enzyme complex then migrate to the infected cell nucleus (Martin and Helenius, 1991).

The events of viral replication in the cell nucleus are complex, and remain to be fully understood. Our information to date suggests that transcription of the messenger RNAs (mRNAs) from all eight fragments of vRNA takes place immediately after entry into the cell nucleus. Initially, similar amounts of each mRNA are produced; however, this is followed by a regulatory phase in which the synthesis of the mRNA coding for NP and NS1 predominates: it is clear that mRNA synthesis is regulated at all stages, and that this regulation is controlled by virus proteins such as P-proteins, NP and NS1 (Krug, 1983). The synthesis of mRNA involves sequentially cap recognition and binding, endonuclease activity, initiation and then elongation to pro-

duced functional mRNA. First, the polymerase complex binds to a methylated cap structure present on heterologous, cellular RNA; this cap recognition is a function of the PB2 protein. Secondly, a nucleotide sequence of 10–13 bases is cleaved from the cap structure by endonuclease activity, termed cap snatching, and this structure forms the starter molecule for mRNAs synthesis: it has been suggested that the cleavage is one of the functions of the PB1 and PB2 proteins (Blok *et al.*, 1996). The cap sequence incorporates a G complementary to the penultimate C of the vRNA to complete the initiation step, and this is a second function of the PB1 protein. Finally, elongation takes place in the normal manner to produce complete mRNAs; this is a function controlled by the PA protein. Cap snatching from the host RNA requires host RNA synthesis, and virus replication is dependent on this process; for this reason, inhibitors such as α -amanitin inhibit influenza virus replication. The mRNAs leave the cell nucleus and bind to ribosomes, and translation of virus proteins is initiated: this process again has not been fully elucidated, and the exact role(s) of the P-proteins and the regulation of the events are not clearly established. The synthesis of cRNA, and subsequently vRNA, occurs after the time of peak production of mRNA and protein synthesis. Full-length vRNAs are produced and exist in approximately equimolar amounts of each throughout infection, and are all synthesized in the infected cell nucleus.

The time sequence for the appearance of the various virus proteins has been studied extensively: the presence of NP can be detected approximately 2 hours after virus infection, and the concentration rises to a maximum at 5–6 hours; the M1 protein appears at 5 hours after infection, and has been identified in both the cytoplasm and to a lesser extent in the nucleus of the infected cells; and the HA and NA appear approximately 3 hours after infection.

Virus assembly occurs when vRNA migrates to the cell surface and virus proteins have also accumulated at this site. Assembly requires the aggregation of one of each of the vRNA components of the complete virus RNA; this is believed to be a random process which accounts for both the numbers of defective particles, and the relative ease with which reassortant viruses can be produced during double infections. The virus HA, NA and M1 proteins are present in the plasma membrane of the infected

cells, and it is this structure which supplies these virus proteins to the assembling particles; it is suggested that this organization of assembly is controlled by the M2 protein, which is present in high concentration at the cell surface. The process of virus release is by budding from the membrane of the infected cells; this is detectable at 5–6 hours after infection and is maximal at 7–8 hours after infection. The mechanism of virus release from the host cell is not known; studies have suggested that it is a function of the virus NA, since antibody to the NA inhibits virus release. Alternatively, the NA might reduce virus aggregation at the cell surface by removing neuraminic acid from the viral envelope.

Viral Variation

Historical Aspects

The explosive nature of epidemic influenza, together with the large numbers of patients involved and the specific clinical features of this disease, has given credibility to records of this infection from the beginning of the eighteenth century. Improved and more precise data, and the laboratory isolation of the influenza virus in 1933, have given accurate records for the past 100 years: the incidence of outbreaks and the numbers of patients involved have not decreased during this period. History records frequent, almost annual, epidemics of influenza; and, since 1700, fourteen pandemics. Accurate documentation of the latter is first seen for the pandemic which spread from Russia into Europe and the USA in the years 1889–1892: the infection presented as an acute upper respiratory tract infection of sudden onset and short duration; the total number of fatal cases was high, particularly among infants and the elderly, but deaths were recorded in only a relatively small percentage of the 25–30% of the world's population infected.

The pandemic of 1918–1920 originated in China or the USA, and is known as the Spanish influenza. The strain of virus which caused the second wave of this pandemic had unusual virulence since it commonly caused a severe and unique form of pneumonia which resulted in at least 20–25 million deaths, principally in young adults. The effects of the pandemic caused international panic and the number of deaths recorded may be only a fraction of the true number: many countries did not report

Table 5.1 Antigenic shift in the haemagglutinin of influenza A viruses

Virus subtype	Virus strain	Serum HI antibody titre to influenza virus ^a			
		A/PR/8/34	A/FM/1/47	A/Sing/1/57	A/HK/1/68
H1N1	A/South Carolina/1/18	NK	NK	NK	NK
	A/PR/8/34	1280	< 10	< 10	< 10
	A/FM/1/47	< 10	640	< 10	< 10
H2N2	A/Sing/1/57	< 10	< 10	1280	< 10
H3N2	A/HK/1/68	< 10	< 10	< 10	1280

NK = not known.

^aInfluenza A viruses grown in eggs were tested in HI tests with antisera from ferrets infected intranasally with live virus and bled 3–4 weeks later. The serum HI antibody titre against 8 HA units of virus is listed.

figures; India was said to have lost a generation; one and a half million deaths occurred in sub-Saharan Africa; the propaganda surrounding the world war of 1914–1918 undermined the accuracy of data from Europe; and the Bolshevik revolution in Russia resulted in ignorance of the effects of the pandemic in that country (Crosby, 1976).

The definition of a pandemic of influenza is an outbreak of infection arising in a specific geographical region, spreading worldwide and infecting a high percentage of people; and caused by a strain of influenza virus which could not have arisen by mutation from strains circulating previously. Thus, the influenza outbreaks of 1932–1933 and 1947–1948 were caused by viruses related to each other, and to the virus thought to have caused the pandemic of 1918–1920: by definition, the outbreaks of 1933 and 1947 were not pandemics. However, a pandemic did occur in 1957 which originated in China, spread through the world, infected 40–50% of people and caused over one million deaths, mainly in the elderly population. Pandemic infection occurred again in 1968, and the event was similar to that in 1957. Since 1968 and in the years between the pandemic years, epidemics of influenza occurred in some countries each year; thus, the pattern is for frequent epidemics interspersed with explosive pandemics which occur every 10–20 years. Since the last pandemic was in 1968, it may be said that the next pandemic is overdue at the time of writing (1999).

Antigenic Shift

The recorded patterns on influenza infection contain two phenomena: the first is the almost annual epidemics which occur in one or more countries, and the second are the extensive pandemics which

occur approximately every 10–40 years. Since 1933 the viruses which cause these two types of outbreak have been isolated and compared in the laboratory. Viruses isolated from patients infected in the years 1933–1946, 1947–1956, 1957–1967 and from 1968 onwards show wide variations, and cross-haemagglutination inhibition (HI) test using antisera from virus-infected ferrets show no serological cross-reactivity (Table 5.1). In addition, RNA sequences recovered and amplified by the polymerase chain reaction (PCR) from postmortem lung tissue of a patient who died of influenza in 1918 indicated that the 1918–1920 pandemic was also caused by an influenza A (H1N1) virus (Taubenberger *et al.*, 1997); this virus and a virus now infecting pigs and the epidemic strains A/PR/8/34 and A/FM/1/47 all belong to one subtype, although showing no cross-reactions in the HI test. The absolute specificity of the HA of the different subtypes indicates that in the years when pandemic infections are recorded, new influenza virus subtypes have emerged against which the population has no immunity: this is known as antigenic shift. Since it is principally antibody to the virus HA which is equated with immunity (see later), infection by influenza viruses of a previous era does not induce HI antibody to the newly emerged virus strain. The historical pattern for pandemic influenza is for a new virus subtype to emerge and spread rapidly, causing explosive outbreaks in many countries. As a result of infection, immunity to the new subtype is built up over a period of years, and further epidemics are more limited. However, after 10–40 years, when the population is largely immune, a new virus subtype emerges with an HA which does not cross-react with antibody to the HA of the previous virus subtype. Consequently, the new virus initiates a new

cycle of influenza infection. These sudden changes in antigenicity can also occur in the virus NA molecule.

Although the HA antigens of influenza A virus subtypes show no cross-reactivity in HI tests, some expression of relatedness is seen in the phenomenon known as original antigenic sin, first reported by Francis *et al.* (1953). This term describes the observation that infection by influenza virus induces antibody to the infecting virus and recalls antibody to the other virus subtypes that the individual has experienced previously; indeed, the titre of antibody to the earlier infecting subtypes can be severalfold greater than that to the current infecting virus. This is probably due to stimulation of B-memory cells which persist after infection being stimulated by the new virus serotype, and suggests a relatedness for the HA antigens of different virus subtypes not detected in HI and other serological tests.

The importance of antigenic shift in producing new antigenic subtypes which spread to cause pandemic infection is evident; but despite some 50 years of intensive research, the origin of these new influenza viruses is unknown. The problem has been of great interest to a large number of virologists; and experiments, epidemiological studies and imagination have produced a number of theories. For example, new serotypes of virus may arise by spontaneous mutation; alternatively, it has been suggested that new viruses could have been introduced from cosmic sources, since the years of some epidemics due to newly emerged subtypes show a loose connection with the occurrence of astral phenomena. Although both these views are present in the literature, only a minority of scientists consider them valid explanations, and convincing evidence to support either of these theories is lacking. Thus, random mutations would be expected to produce intermediate strains, and such strains have not been identified; detailed analysis has shown that new virus subtypes have multiple sequence difference, and it is difficult to imagine these all occurring simultaneously.

The most widely held theory for the origin of the new influenza virus is that new virus subtypes are reassortant viruses resulting from double infection. The appearance of a new influenza virus subtype is paralleled by the disappearance of the old subtype (an exception has occurred in most recent times, when two virus subtypes have circulated concurrently), and it would therefore seem unlikely that

the dual infection was by two subtypes of human influenza viruses. However, influenza A viruses infect other species, including horses and in particular birds: dual infection with human and animal or bird viruses in a species which could support the replication of both could result in the production of a reassortant virus with surface antigen(s) from the animal virus and infectivity for humans. This theory is scientifically tenable: reassortant viruses can be produced in the laboratory from human and animal parents; reassortants can be identified following mixed infection of animals or birds; influenza viruses can cross species barriers; and antigenic analysis of two human influenza virus subtypes has revealed similarities between the HA of these viruses and known avian viruses. In contrast, although animals have been infected with human influenza virus following epidemic infection of humans, no epidemiological evidence has been found to suggest that the HA of an animal or avian influenza virus has subsequently occurred on a novel human influenza virus subtype which then caused pandemic infection. Influenza B viruses do not occur in animals and do not exhibit antigenic shift: this has been put forward as indirect evidence for reassortment as the mechanism for the emergence of new influenza A virus subtypes.

Finally, it has been suggested that there are a limited number of influenza A subtypes which are recycled in the human population. Evidence for this theory comes from seroepidemiological studies of antibody to influenza viruses in sera taken at different times from subjects of different ages. In a number of such studies, antibody to a human influenza virus subtype was identified in serum samples from elderly persons taken years before the appearance of the same subtype as a cause of pandemic infection. From these observations, it has been suggested that all influenza virus subtypes exist cryptically in nature, and emerge when the antibody status of the population has fallen to levels which allow pandemic infection: a cycle of approximately 70 years and involving the subtypes which caused the pandemics recorded since 1889 would satisfy this requirement. The evidence supporting this theory is fragile. Although serological studies have detected the presence of antibody to the influenza virus subtype (H3N2) which was first seen in 1968 in sera from aged persons collected before the epidemic, no reservoir for the virus in humans or animals before this epidemic has been found. Again, it can be ar-

Table 5.2 Antigenic drift in the haemagglutinin of influenza A (H3N2)

Virus subtype	Virus strain	Serum HI antibody titre to influenza virus ^a				
		A/HK/1/68	A/Eng/42/72	A/PC/1/73	A/Vic/3/75	A/Bang/79
H3N2	A/Hong Kong/1/68	1280	320	40	40	< 10
	A/England/42/72	240	2560	80	120	40
	A/Port Chalmers/1/73	40	120	5120	320	160
	A/Victoria/3/75	< 10	40	640	1280	160
	A/Bangkok/1/79	< 10	< 10	80	160	640

^aSee footnote to Table 5.1.

gued that no reservoir is necessary to support the theory: reassortants may be appearing all the time, but only when the immune status of the population has waned by deaths in the older generation can pandemic infection occur due to a virus similar to that which occurred in years past. It is clear from the above that the origin of new virus subtypes is not known; but the great advances made in recent years in influenza surveillance, diagnosis and antigenic analysis will be applied to the virus which causes the next pandemic, and this may provide proof for the mechanism of antigenic shift.

Current concern for a future pandemic has been recently demonstrated during the outbreak of influenza A (H5N1) virus infection among chickens in South China, and later in Hong Kong, which caused extensive mortality (March, 1997): from these infections, 17 cases occurred in humans, five of which were fatal. Following these events, the Hong Kong authorities slaughtered 1.7 million chickens (December, 1997), and since this time no further human cases have been reported. The episode has underlined a number of points: firstly, avian viruses have little infectivity for humans, and in spite of massive exposure only a small number of human cases occurred; secondly, the episode evoked a rapid and intense response from virologists and others, and the strategy of slaughtering vast numbers of chickens emphasized the international concern of pandemic influenza, based on the history of massive pandemics and great mortality, and the will to take rapid and dramatic action in the face of a possible pandemic; and thirdly, although the avian influenza A (H5N1) virus had little infectivity for humans, recombination of this strain with a human influenza A virus in a third species susceptible to both, could produce a recombinant and the start of a pandemic in the future.

Antigenic Drift

In addition to the large pandemics of influenza virus infection seen every 10–40 years due to the occurrence of new influenza virus subtypes showing antigenic shift, there are also epidemics of a smaller nature occurring in the intervening years. When the virus from various epidemics between pandemics are compared in cross-haemagglutination tests, they exhibit strain differences: thus, although all the viruses belong to the same subtype, they do not cross-react completely; these changes are termed antigenic drift. Table 5.2 shows the HA variation found with some influenza viruses isolated from 1968 to 1979: all belong to the same subtype but were associated with the epidemics of 1968, 1972, 1973, 1975 and 1979. The virus of 1968 (A/HK/1/69) reacted most strongly with homologous antiserum, but some cross-reactions were seen with other viruses in the series; the degree of cross-reactivity decreased as the time difference increased. The same is true for the other virus strains in the series; and similar drift can be seen for strains isolated from 1979 to the present day (not shown). The practical effects of antigenic drift are that infection by one strain may induce some cross-reacting antibody and partial immunity to infection by other viruses of the same subtype, and the degree of cross-immunity is directly related to the degree of cross-reactivity.

A theory for the mechanism for antigenic drift is generally agreed among scientific workers. This theory proposes that virus variants arising naturally and showing small differences in antigenic determinants are selected by antibody pressure in an immune or partially immune population; since these new variants are not neutralized by antibody to pre-existing virus strains, they are selected out to cause new epidemics. Selection based on the rela-

Table 5.3 Nomenclature of influenza A viruses

Haemagglutinin		Neuraminidase	
Subtype	(Previous designation)	Subtype	(Previous designation)
H1	(HO, H1, H _{sw})	N1	(N1)
H2	(H2)	N2	(N2)
H3	(H3, Heq2, Hav7)	N3	(Nav2, Nav3)
H4	(Hav4)	N4	(Nav4)
H5	(Hav5)	N5	(Nav5)
H6	(Hav6)	N6	(Nav6)
H7	(Heq1, Hav1)	N7	(Neq1)
H8	(Hav8)	N8	(Neq2)
H9	(Hav9)	N9	(Nav6)
H10	(Hav2)		
H11	(Hav3)		
H12	(Hav10)		
H13	(—)		
H14	(—)		
H15	(—)		

tively small changes in the antigenicity of the virus HA that characterize antigenic drift can be achieved in the laboratory and in animal models; thus, virus strains with antigenic changes detectable by serological and biochemical techniques can be recovered by growth in low concentrations of antibody. Antigenic drift also occurs in the NA antigen. Epidemics due to new virus strains exhibiting antigenic drift are not as great as for those showing antigenic shift, since partial immunity is present in persons with cross-reacting antibody induced by previous infection.

Virus Classification

In addition to the viruses which affect humans, influenza A viruses also occur in pigs, birds and horses; however, only humans are infected by influenza type B and C. The antigenic differences of the HA and NA antigens of influenza A viruses provide the basis of their classification into subtypes. This classification is of practical importance since cross-immunity between viruses of different subtypes does not occur, and the antigenic differences are critical for the understanding of virus epidemiology and for vaccine production. Many schemata for the classification of influenza A virus have been proposed in the past, but at the present time the agreed classification is shown in Table 5.3. Previously, the results of serological studies have suggested that the

HA of the influenza virus strain which affects swine, termed H_{sw}, is similar to that which caused the pandemic of 1918–1920, and this has been confirmed by sequence data from virus RNA recovered from a postmortem specimen from the lung of a victim of the pandemic (see above). The strains occurring in the years 1933–1948 were classified as subtype HO; and those occurring between 1947 and 1957 were termed H1. More recent studies have shown that the HA of all these viruses are related, and the classification shown in Table 5.3 groups these viruses into a single subtype termed H1. The H2 subtype caused infection in humans between 1957 and 1968, and the H3 from 1968 to the present time (1999); the H1 serotype reappeared in 1976 and has also caused infection since that time. The HA of human subtype H3 cross-reacts with the HA of equine influenza virus Heq2 and avian influenza virus Hav7, and these three also are now grouped into the single subtype H3. Further subtype classification is dependent on evidence of cross-reactivity between the various viruses, and the classification shown in Table 5.3 gives the new and old designations. To date, a total of 15 distinct HAs have been recognized among the influenza A viruses: the most recently recognized subtypes are H14, identified in 1990 in a virus infecting wild duck in Russia (Kawaoka *et al.*, 1990), and H15 identified in viruses affecting birds in Australia and reported in 1996 (Rohm *et al.*, 1996). In spite of the intensive investigation, no further subtypes have been recognized in any of the many species tested.

Antigenic differences also occur in the NA antigen of the influenza A viruses. The antigenic form designated N1 is found in all human influenza A viruses isolated prior to 1957, and the form N2 has been found in all human isolates recovered since that time; a recurrence of infection by strains having an N1 neuraminidase occurred in 1976, and these strains have been regularly recovered from patients since that date. The other antigenic variants of the NA occur in virus strains isolated from birds and horses (Table 5.3).

Using the classification, it is possible to describe any influenza virus in terms of its subtype specification. Every influenza virus is referred to as A or B, followed consecutively by the place of isolation, the laboratory number and the year of isolation: following this designation, parentheses contain the subtype designation. Thus influenza virus A/Hong Kong/1/68 (H3N2) signifies an *Influenza A virus*

isolated from a patient in Hong Kong in 1968, and of subtype H3N2.

PATHOGENESIS

There is no agreed explanation for the pathogenesis of human influenza, and many features of the disease are not understood. However, histological and virological investigations by a number of workers have broadly delineated the effects of virus infection. Infection is the result of inhaling respiratory droplets from infected persons; these droplets containing virus are deposited on the mucous blanket lining of the respiratory tract. Much virus is destroyed by non-specific immune barriers, such as mucous binding which is functional at this site, but some virus released from mucous by the action of virus neuraminidase attaches by the virus HA to receptors on the cells of the respiratory epithelium: epithelial cells of both the upper and lower respiratory airways are rich in virus receptors. Following virus attachment, replication proceeds: virus can be isolated following acute infection for 1–7 days, with peak titres usually occurring 48–72 hours after the onset of symptoms. Histological studies on nasal exudate cells and tracheal biopsies have indicated that the major site for virus infection is the ciliated columnar epithelial cells. Following infection these cells become progressively rounded and swollen, and the nucleus appears shrunken and pycnotic; the cytoplasm becomes vacuolated, the nucleus degenerates and ciliation is lost. Immunofluorescence studies have shown these cells to contain much virus-specific protein.

The progression of changes in the cells of the respiratory epithelium suggests that they begin in the tracheal bronchial epithelium and then ascend. Thus, early lesions in the tracheobronchial mucosa have been described in uncomplicated influenza, as evidenced by clinical bronchitis and tracheitis; the tissues show increased permeability of vascular capillary walls, oedema, polymorphonuclear infiltration and phagocytosis of degenerate epithelial cells. The basement membrane is not affected.

Because of the generalized symptoms present in uncomplicated influenza, viraemic spread from the respiratory tract has been suspected and virus can replicate in other cells, such as macrophages. However, demonstrations of viraemia have not been

conclusive; and blood samples from children infected with influenza were not found to contain virus when tested by the very sensitive PCR technique (Mori *et al.*, 1997).

Virus infections have been associated with specific ECG and EEG changes; some unconfirmed reports of virus antigen in brain and heart tissue have been recorded; and influenza has been temporally associated with cases of virus encephalitis, particularly among children. In addition, the failure to prove viraemia at least in some cases leaves unexplained the myalgia and degree of prostration which are commonly seen in influenza, and the sudden and marked temperature rise which occurs following infection. The virus has been shown to have strongly pyrogenic properties when inoculated intravenously into animals, but the quantities of virus needed to demonstrate this effect are unnaturally high. It has been postulated that the mononuclear cell infiltration of infected tissue which occurs during infection may result in the release of pyrogens, or that infection results in the induction of cytokines which may be relevant to the systemic symptoms, but these hypotheses remain unproven.

CLINICAL FEATURES

Uncomplicated Infection

Influenza has been described as an unchanging disease due to a changing virus, and this description underlines the relative constancy of the clinical presentation of the infection. Detailed analysis of the symptoms seen in the groups of patients studied in the years 1937–1941, 1947 and 1957 indicate some differences in the relative incidence of some symptoms; however, these are probably due to the variable opinions of different observers. Although the clinical presentation of uncomplicated influenza in any one age group is generally agreed, variation in incidence of certain symptoms does occur for different ages: thus, croup is more a feature of infection in young children; sore throats are seen more commonly in adults; vomiting and convulsions are rarely seen except in infants; and myalgia is more common in adults.

Following droplet infection from infected individuals, the incubation period is 48 hours, but may

vary from 24 to 96 hours; the variation is probably dependent on the size of the infecting dose. The onset of illness is usually abrupt, and many patients can pinpoint the hour of onset. The symptoms in adults commonly include a marked fever, headache, photophobia, shivering, a dry cough, malaise, aching of muscles and a dry tickling throat which can lead to the voice becoming husky and even lost. The fever is usually continuous, and classically lasts for 3 days, at which point the temperature falls and the symptoms abate; in a percentage of cases, a second spike may occur after this time which is smaller than the first but gives the common biphasic fever curve. Of the acute symptoms listed, the cough may persist for several days; the eyes are often watery, burning and painful in movement; the nose can be blocked or may have a purulent discharge; cervical adenopathy is unusual but has been described; and myalgia is most severe in the leg muscles, but also may involve the extremities. Although the infection usually resolves within 7 days, patients commonly complain of feeling listless and unwell for weeks after acute infection, and depression is a common residual complaint.

Studies of the clinical illness resulting from infection by *Influenza B virus* show close similarity to those caused by *Influenza A virus*. Thus, infection is commonly a 3 day illness with predominant systemic symptoms. Some authors have suggested that influenza B virus infections are milder than those caused by influenza A, with less myalgia and a higher incidence of nasal symptoms, and differences have been reported for the incidence of sweating and other symptoms; however, these differences are small. In contrast, influenza C infection is usually a relatively mild respiratory infection of young children and a mild upper respiratory tract infection of adults which is rarely diagnosed.

Tracheobronchitis and Bronchitis

All series of patients studied have included a small proportion in whom the respiratory symptoms were more severe. These patients have a productive cough, chest tightness and substernal soreness. Rales and rhonchi are commonly heard but the lungs are radiologically clear. These symptoms are most commonly seen in patients with chronic obstructive bronchitis and in older persons, and it is

evident that age and chronic pulmonary disease predispose to bronchitis, which can result in deaths from influenza in such patients.

Pneumonia

Pneumonia in patients with influenza virus infection can be a primary viral pneumonia or secondary bacterial infection. In viral pneumonia, patients develop persistent fever with leucocytosis, dyspnoea, hypoxia and cyanosis following the acute symptoms described above. Sputum specimens will show no clear bacteriological cause, and a proportion of these patients will die of diffuse haemorrhagic pneumonia as a direct result of infection. Autopsies show congested, dark, red lungs, and the mucosa of the trachea and bronchi will be hyperaemic; microscopic examination of lung sections has consistently revealed tracheitis and bronchiolitis with haemorrhage, hyperaemia, a small cellular infiltrate and a loss of ciliated epithelium. An alveolar exudate containing both neutrophils and mononuclear cells in haemorrhage is common. This complication of influenza is relatively uncommon, but cases have been demonstrated in many influenza epidemics: pneumonia can occur in previously young and healthy persons, but is more commonly associated with patients with pre-existing cardiovascular disease such as rheumatic heart disease. The pathology of the viral pneumonia which killed many relatively young and previously healthy people during 1918–1920 was unique to that pandemic (Crosby, 1976).

The pneumonia following influenza virus infection can be a secondary bacterial pneumonia: this is more common than primary viral pneumonia, and usually occurs late in the course of the disease. It usually ensues after the period of improvement from the acute symptoms of infection. The symptoms and signs are those of typical bacterial pneumonia, and of the organisms involved *Staphylococcus aureus* is the most common, but *Streptococcus pneumoniae*, *Haemophilus influenzae* and other bacteria may also be found. The association of *Staph. aureus* with secondary bacterial pneumonia following influenza is much more common than might be anticipated, and there appears to be a good reason for this. Infection of cells by *Influenza A virus* requires cleavage of the virus HA by proteases, and

some strains of *Staph. aureus* produce such enzymes; thus, in secondary bacterial pneumonia *Staph. aureus* and influenza virus may each promote infection by the other (Tashiro *et al.*, 1987). The incidence of secondary bacterial pneumonia is most common in the elderly and those with underlying disease, such as congestive heart failure and chronic bronchitis; in addition, patients with diabetes mellitus, renal disease, alcoholism and those who are pregnant may also have an increased susceptibility to secondary bacterial pneumonia.

Myositis and Myoglobinuria

In addition to myalgia, which is a characteristic feature of acute influenza infection, clinical myositis and myoglobinuria can occur. The symptoms usually develop soon after the subsidence of the acute upper respiratory tract symptoms: the muscles are painful and tender to touch, but neurological symptoms are not evident. Laboratory studies have shown changes in the serum aspartate and alanine aminotransferases and creatinine phosphokinase levels in many of these patients, and histological examination of muscle biopsies has revealed necrosis of the muscle fibres and a mononuclear cell infiltration.

Reye's Syndrome

A syndrome characterized by encephalopathy and fatty liver degeneration was originally described in 1929, and more fully characterized by Reye *et al.* (1963); later observers noted an association of recent viral infection with this syndrome, now termed Reye's syndrome, and the aetiology of the condition has been intensely researched. Originally thought to be a rare condition, it is now recognized as more common; cases have been reported from many countries, and analyses of series of patients have been published from the UK and USA (Corey *et al.*, 1976). Typically, a previously normal child has a virus-type prodromal illness followed in a few days by vomiting, altered consciousness and, occasionally, convulsions; the liver may be enlarged, and there is evidence of hepatic dysfunction with raised transaminase and blood ammonia levels. Fatalities from this syndrome are 40–50% of hospital admis-

sions; at autopsy an enlarged, pale and fatty liver is usually seen, and histological examination of the liver shows diffuse panlobar microvesicular fatty infiltration. The brain shows evidence of encephalitis with cerebral oedema.

The association of Reye's syndrome with a preceding viral infection was noted in early studies of this disease. An association with prior infection with *Influenza B virus* was first reported; however, subsequent studies have associated Reye's syndrome with prior infection by other viruses, including *Influenza A virus*, *Varicella zoster virus*, herpes simplex virus, *Coxsackie virus B5*, echovirus, adenovirus and cytomegalovirus. The incidence of Reye's syndrome by age and the nature of preceding infection is seen in the results of a series of 367 cases studied in the USA between 1973 and 1974; these findings are shown in Figure 5.3. The modal age was 11–14 years; although a significant number of cases occurred in younger persons, the syndrome was rarely seen in patients aged 18 years or older. A prior respiratory tract infection was recorded for the majority of patients; in some patients this was identified as influenza B infection, seen mainly in children aged 11–15 years, while varicella was identified in other cases, mainly in children aged 3–8 years. Outbreaks of Reye's syndrome have been recorded in conjunction with influenza A or B epidemics, and the clustering of cases in the winter months is illustrated in Figure 5.3a. Finally, the mortality rate for the series illustrated in Figure 5.3 was 41%.

The pathogenesis of Reye's syndrome remains obscure. An experimental disease similar to Reye's syndrome can be induced in mice by intravenous inoculation of *Influenza B virus*; and other studies have suggested that acute virus infection in conjunction with cofactors may be responsible for initiating the pathology of the disease. In particular, the use of high concentrations of aspirin in conjunction with acute virus infection has been suggested as a possible precondition for the development of Reye's syndrome; there are epidemiological data to support this association.

Congenital Malformations

The literature contains a number of reports of an increased incidence of congenital malformations

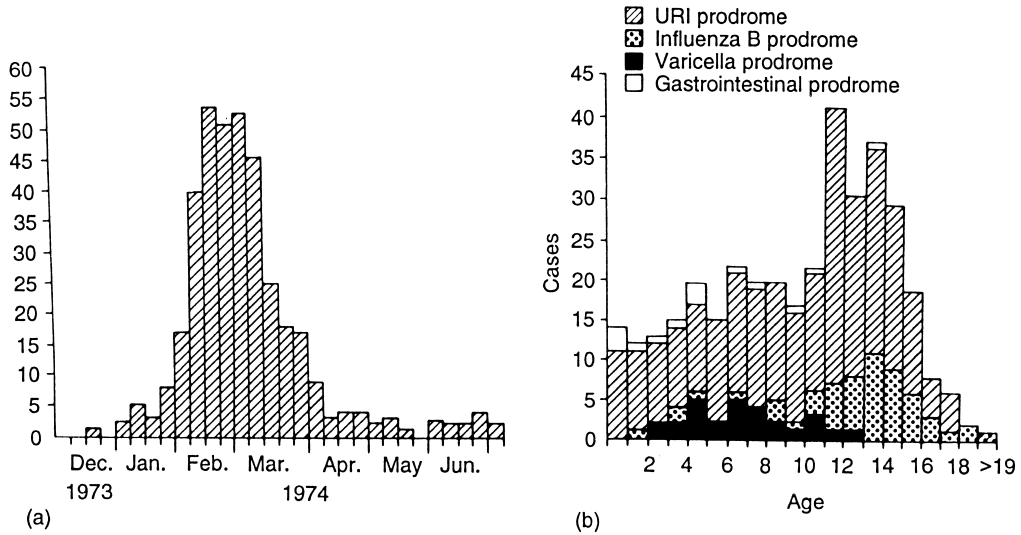

Figure 5.3 Seasonal occurrence (a) and age and associated infection (b) in 367 cases of Reye's syndrome. URI = upper respiratory infection. (Data from Corey *et al.*, 1976)

(Conover and Roessmann, 1990) and neural tube defects (Lynberg *et al.*, 1994) following influenza virus infection during pregnancy. Transplacental passage of the virus has been demonstrated, but prospective studies of congenital abnormalities following epidemics of influenza have failed to establish a relationship between influenza virus infection and these abnormalities. No conclusions are justifiable from our present knowledge; there may be a risk of anencephaly following influenza infection in the first trimester of pregnancy, but this risk is probably very small.

Other Complications

Although influenza in healthy adults is normally severe but of short duration, resolving in 3–5 days, complications can occur, particularly in elderly patients and those with predisposing conditions, and these have been outlined above. In addition, virus infection can result in a number of other less well understood complications. Influenza can cause ketoacidosis in diabetic patients, even in relatively mild cases of virus infection. Infection has been implicated in acute viral encephalitis and in Guillain–Barré syndrome, and deaths have been reported in both these groups. Histological examination of brain tissue has shown no gross abnormali-

ties but small changes consistent with viral encephalitis have been shown, and virus has been isolated at autopsy from the lungs of fatal cases of encephalitis. The pathogenesis of these neurological complications is unknown, since virus recovery from the brain has been infrequently documented.

Epidemiological studies have associated some subtypes of influenza A with sudden unexplained death and sudden infant death syndrome, sometimes called cot death syndrome (Zink *et al.*, 1987). Firm data associating acute influenza infection with sudden infant death syndrome have been sought by many workers in the past, but have been difficult to obtain; and the association is made on circumstantial evidence and remains speculative. Influenza virus infection, and the association of this infection with secondary *Staph. aureus* infection (see above), can result in toxic shock syndrome; this complication of influenza infection has been reported by a number of observers. Finally, reports of an association of maternal influenza with schizophrenia in offspring and Parkinson's disease are in the literature, but the evidence of association is both fragile and contradictory (O'Callaghan, 1991).

DIAGNOSIS OF INFECTION

During epidemics of influenza, large numbers of

patients are seen with similar symptoms; if it has been established that influenza virus is circulating in the community, an association of patients with contacts diagnosed as having influenza may suggest that the diagnosis is self-evident. However, influenza A and B can coordinate, and mixed epidemics of influenza and other viruses have been reported; under these circumstances presumptive diagnoses can be misleading. Again, the symptoms of influenza in any group of patients are clearly different from those due to other virus infections; however, the symptoms and signs for any one patient may vary, such that a diagnosis on clinical criteria cannot be confidently made. Theoretically, it is advisable that all diagnoses should be confirmed by laboratory tests, but in practice this is not always feasible. More importantly, isolated cases of suspected influenza should be investigated, since these may represent the first case of an impending epidemic or infection by a new virus strain: diagnosis of these cases is not of benefit to the individual patient but is an important signal of what may happen subsequently in the community. The recognition of index cases activates preventative measures to protect subjects for whom influenza is a life-threatening infection.

The laboratory diagnosis of influenza is based upon the isolation and identification of virus from pathological specimens, and/or the demonstration of a significant increase in specific antibody titre between serum specimens collected at the onset of infection and 2–3 weeks later. The isolation of virus can only be achieved in a limited number of cases, since virus may have disappeared by the time the specimens are taken, and the methods used for virus isolation lack sensitivity; however, direct methods of detecting viral nucleic acid by PCR, and viral protein by ELISA tests or with fluorescein-labelled antibody are increasingly available, refined and rapid. Serological tests provide the most sensitive and practical alternative for diagnosis in the absence of virus isolation; but, since they require a convalescent serum specimen, the diagnosis is retrospective. However, a diagnosis may be made on a single serum sample by demonstrating the presence of a virus-specific IgM response; such responses may be present for about 8 weeks, occasionally longer, following influenza infection.

Virus Isolation and Identification

Pathological Specimens

Influenza viruses replicate in the upper respiratory tract, and are present in these tissues and in respiratory secretions; virus is not found in other tissues, although occasional reports of virus isolation from brain, heart tissue and blood are documented. Serial specimens of respiratory secretions from patients with influenza indicate that the maximum titre of virus is present on days 2 and 3 after the onset of symptoms, but virus is detectable from days 1 to 5. Throat or nasopharyngeal swabs can be taken into a suitable transport medium, or nasal washings can be collected. Comparative studies have shown that virus can more commonly be isolated from nasal washings than from other specimens.

Culture in Embryonated Eggs

Influenza viruses A and B, present in pathological specimens and collected into transport media, can be cultured by amniotic inoculation of 10–12 day embryonated eggs. The virus is absorbed from the fluid of the amniotic cavity on to the cells of the amniotic membrane in which they multiply, releasing newly formed virus back into the amniotic fluids. After 2–3 days incubation, virus can be present in high titre in the amniotic fluid and can be detected by adding aliquots of harvested amniotic fluid to chick, turkey, guinea-pig or human erythrocytes and observing haemagglutination. Egg fluids negative for virus can be passed to further embryonated eggs and retested: experience has shown that further passage is unwarranted, and specimens which do not reveal virus after two egg passages are recorded as negative.

Tissue Culture

Pathological specimens can be inoculated on to tissue cultures of kidney cells from rhesus monkeys, baboons, chicks or a variety of other species; again, experience has shown that rhesus monkeys and baboon kidney cells are probably the most sensitive. After absorption and incubation of virus-infected cells, newly produced virus can be detected by a number of methods. First, free virus released into the maintenance medium of the tissue culture can be detected by haemagglutination with eryth-

rocytes, as described for amniotic fluid (see above). Secondly, since virus is released slowly from the cell surface of infected cells, erythrocytes will adhere directly to these infected cells; this phenomenon is termed haemadsorption, and can be observed under the microscope. Finally, and more rapidly, virus can be detected in infected cells by fixation and staining with specific, fluorescein-labelled antibody (Brumbeck and Wade, 1996).

Virus Recognition

Influenza viruses isolated from embryonated eggs or tissue culture can be identified by serological methods. First, influenza viruses can be recognized as influenza A, B or C by complement fixation (CF) tests using extracts of infected cells or embryonic membranes, which contain high titres of NP antigen, and standard antisera against influenza A, B or C viruses. An NP antigen is found for all influenza A, B or C virus types, and antibody against one type does not react with soluble antigen of another type: thus, the influenza type can be unequivocally identified in this manner.

The further classification of influenza isolates into subtypes and strains is a highly specialized responsibility of WHO reference laboratories: these determinations are carried out on virus isolates forwarded from laboratories to these centres. Each virus isolate is tested by HI tests against antisera raised in experimental animals against a range of virus subtypes and strains: the titre of each sera against homologous virus is known from prior testing. The submitted virus strains are standardized to contain a fixed amount of HA activity by titration against chick erythrocytes, and then reacted against a range of dilutions of each antisera. By observing the patterns of HI against the various antisera, the virus subtype and strain is identified. Should the virus isolate not be inhibited by any of the sera to the same titre as known for homologous virus then the strain may be a new subtype or strain: homologous sera against this strain is then prepared in animals, and more extensive cross-HI tests performed. These tests require the constant addition of new control sera to the battery of antisera, and experience in interpreting the results.

In addition, to identify the HA of the virus isolate, the NA is also typed. This is done by identifying which antisera prepared against the various influenza virus NAs will inhibit the NA of the unknown

virus to the same titre as against homologous virus; the indicator system in this test is an NA substrate, such as fetuin.

Rapid Diagnosis

Immunoreactions

Since influenza virus is very rarely isolated from symptom-free persons, the isolation of virus from patients may be taken as proof of infection without the need for diagnostic serology; however, using conventional egg and tissue culture techniques (see above) this procedure takes at least 2–3 days, and in practice probably a week, to complete. Since clinicians may confidently expect antiviral agents for the treatment of influenza to be available in the near future, more rapid methods of diagnosis are needed if these compounds are to be used rationally. In addition, more rapid diagnostic methods would allow the earlier initiation for measures to limit the spread of infection. One procedure for rapid diagnosis has been investigated by many workers, and relies on the direct identification of virus and virus antigens in infected cells of the respiratory epithelium, and these are constantly shed into the respiratory secretions: these cells can be removed either in throat washings or scraped from the tissue surface with a metal spoon. In the laboratory, the cells are placed on a glass slide, fixed and stained by an indirect immunofluorescence (IF) or an ELISA technique using antisera against influenza virus; the IF staining can be accelerated by treatment with microwave irradiation for a few seconds (Hite and Huang, 1996). The procedure can be completed within 1–2 hours of specimens arriving in the laboratory, and offers obvious advantages. Many workers have investigated this method; some are convinced of the value of the technique, but others have been disappointed with the specificity of antisera available and the level of background reaction, particularly fluorescence, which makes the test difficult to interpret; however, better reagents are becoming available and the method offers a considerable advance over existing methods for the future.

Molecular Biology

Developments in molecular biology have provided reagents and techniques for the diagnosis of numer-

ous microorganisms, and these techniques are equally applicable to the detection of influenza viruses. Thus, influenza virus RNA can be detected using DNA probes by molecular hybridization; the reactions can be detected by using either isotope- or biotin-labelled probes (Uryvaev *et al.*, 1990). Viruses can be detected by PCR: virus RNA sequences are transcribed into cDNA by reverse transcriptase, and then amplified using specific DNA primers; the amplified sequence is then detected by polyacrylamide gel electrophoresis as a molecule of predicted molecular weight. The sensitivity of the PCR technique is unsurpassable, since theoretically one RNA sequence can be amplified to several million DNA sequences; thus, the technique offers exquisite sensitivity, but great care must be taken to avoid cross-contamination (Zhang and Evans, 1991). Although influenza virus is not isolated using conventional techniques from normal persons (see above), this conclusion must be independently tested if the PCR reaction is used. The method can be refined for the detection and identification of virus strains (Wright *et al.*, 1995).

Serology

Although isolation of virus from respiratory secretions is recommended to establish the diagnosis for all suspected cases of influenza, virus cannot be isolated from all cases of infection. More commonly the diagnosis is made retrospectively by the demonstration of a rise in serum antibody to the infecting virus. For this, blood samples are taken as early after the onset of symptoms as possible (acute specimen), and 14–21 days later (convalescent specimen); these sera are titrated for virus antibody, and the demonstration of a fourfold or greater increase in antibody titre in the convalescent sera as compared to the acute sera is diagnostic of infection. A common method for measuring antibody titre is by CF: soluble antigen is extracted from embryonic membranes of infected eggs, and is reacted against a range of dilutions of the acute and convalescent sera. This test is often positive for patients from whom virus could not be isolated.

A more specific test for antibody to influenza virus is the HI test. For this, paired sera from patients with suspected influenza virus infection are treated to remove non-specific inhibitors, and a

series of dilutions made: to each dilution is then added a standard quantity of intact virus, and after incubation chick erythrocytes are added. The presence of antibody is indicated by inhibition of haemagglutination. A further technique for detecting serum antibody is the haemadsorption inhibition test. In this test, mixtures of standard virus and serum dilution are inoculated on to tissue cultures of monkey kidney cells and incubated: after 2–3 days, the cultures are washed, guinea-pig erythrocytes added, and the cultures viewed under the microscope. The presence of haemadsorption indicates virus replication and the absence of antibody, whilst no haemadsorption indicates neutralization by antibody in the serum. By testing each serum over a range of dilutions, the titres of antibody can be determined; again, a fourfold or greater rise in titre is diagnostic of infection.

Infection by influenza viruses results in a rise in serum antibody titre, but the requirements for an equal or greater than fourfold rise in titre of HI or CF antibody reflects the inaccuracy of these tests for detecting increases in antibody. A more precise method of measuring antibody is by the single radial haemolysis technique. Here, influenza virus is coated on to sheep red cells, and suspended in melted agar with complement: the agar is poured into dishes or on to glass slides and, after setting, wells are cut in the agar and inoculated with dilutions of test sera. The presence of antibody in the serum is detected by lysis of the red cells as antibody combines with complement and antigen on the red cell surface. This lysis can be seen with the naked eye, and the amount of antibody present is directly related to the area of the zone of haemolysis. The procedure is more sensitive than CF or HI tests and has a greater degree of precision: a 50% increase in zone area represents a rise in antibody and is evidence of recent infection. Sera do not require pre-treatment to remove the non-specific inhibitors which plague the HI test.

TREATMENT AND PREVENTION

The clinical severity of influenza, with high temperature, respiratory symptoms, myalgia and severe prostration, requires most patients to seek bed rest during the acute phase of illness; the exhaustion and depression which follow may require further rest

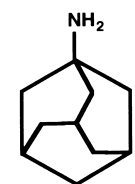

L - Amantadine

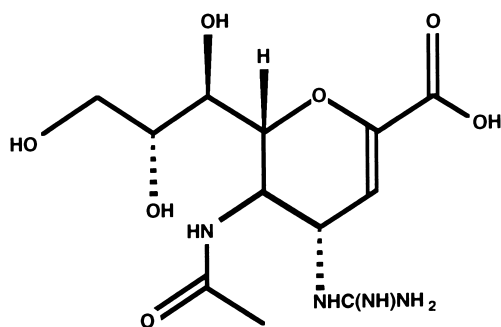

4-Guanidine-Neu5Ac 2en (GG167)

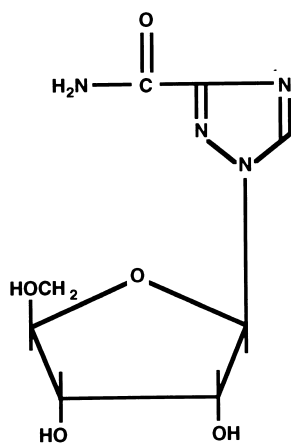

Ribavirin

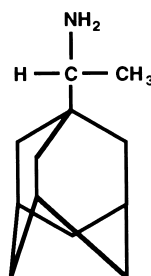

Rimantadine

Figure 5.4 Structure of four antiviral compounds

and convalescence. During epidemics symptoms can affect tens of thousands of individuals, causing disruption to industry, services and social life; causing a significant number of deaths; and resulting in complications such as pneumonia and Reye's syndrome which are life-threatening to both old and young. From these observations, it is clearly desirable that adequate means of treatment and prevention should be developed; but despite this need, which has been recognized throughout this century, progress has been relatively slow, and the impact of epidemic influenza has changed little since the virus was first isolated some 60 years ago. Some progress

has been made, and this can be summarized under the separate headings of treatment and prevention.

Treatment

At the present time treatment of influenza is usually symptomatic. Patients are advised to remain in bed for 2-3 days until the acute symptoms have subsided. The symptoms of headache and fever were commonly treated with salicylates, but in view of the evidence that a combination of salicylates and

acute influenza virus infection may underlie the pathogenesis of Reye's syndrome in children, paracetamol should be used in place of salicylates. Codeine linctus may relieve the cough; insomnia may be treated with barbiturates or promethazine (an antihistamine with hypnotic side-effects); and antibiotics are indicated where chest complications are present or suspected. The use of prophylactic antibiotics in patients with chronic chest disease who thus have a higher risk of developing postinfluenza pneumonia is contentious. Some advocate this practice, but the incidence of secondary bacterial pneumonia is not reduced and infection may be by antibiotic-resistant organisms.

Since the earliest conception of antiviral chemotherapy, influenza has been one of the target diseases against which suitable antiviral compounds should be developed. The search for such compounds has used two methods. One is the rational approach, which predicts potential valuable substances that would interfere with virus replication; this requires an exact knowledge of the molecular events of virus infection and multiplication, and such information is not complete. The other is the serendipity approach, which requires the random screening of chemical compounds in the hope that an active compound will be found by chance. To date both strategies have had similar limited success: no entirely satisfactory agent has been found, but compounds with antiviral activity against influenza have been identified.

Amantadine, Rimantadine

Amantadine and rimantadine are synthetic, water-soluble primary amines with a symmetrical structure; basically, they consist of a stable base with an active amino group (Figure 5.4). In experimental studies, the compounds have been shown to inhibit the growth of influenza viruses in cell culture; to limit virus replication in mice, ferrets and other experimental animals; to reduce tissue damage by influenza virus in infant rats; and to protect hamsters from infection from virus-infected animals placed in the same cage (Potter and Oxford, 1977). On the other hand, the compounds are not equally active against all influenza virus strains; resistant strains can arise during treatment; naturally occurring resistant strains have been isolated; and the compounds are not active against influenza B viruses. Studies on the mode of action of amantadine have

indicated two features of antiviral activity. First, the compound acts at the level of virus uncoating by lysosomal enzymes: this process requires the ion channel formed by the M2 protein and a fall in pH (see above) for optimal enzyme activity, but amantadine blocks this channel and thus uncoating and subsequent viral replication are limited. Secondly, the action of amantadine on the M2 ion channel activity inhibits the transport of HA and other viral subunits at the cell surface, which in turn limits virus assembly (Lin *et al.*, 1997).

Clinical studies with amantadine have shown that the compound can occasionally induce mild neurological symptoms; these include insomnia, loss of concentration and mental disorientation. The symptoms are quickly shown by susceptible individuals, and cease when treatment is stopped. If these symptoms do not occur within 24 hours of initiation of amantadine treatment they are unlikely to occur at all. With these reservations in mind, amantadine has been subjected to clinical trials, and satisfies the basic requirements of non-toxicity. Both prophylactic and therapeutic studies have been carried out. In the most convincing prophylactic trials, index cases of influenza were identified in closed groups of subjects in schools or universities, and unaffected volunteers from among the contacts were given either amantadine or a placebo: these studies indicated an approximate 70% protection for those taking amantadine prophylactically (Dolin *et al.*, 1982). In a therapeutic study carried out among patients attending general practitioners, volunteers with symptoms of influenza were treated with either amantadine or placebo in a double-blind study. The diagnosis of influenza was confirmed by demonstrating a significant rise in serum HI antibody, and only patients in whom the diagnosis was confirmed were included in the subsequent analysis. Amantadine significantly reduced the duration of the fever (51 hours as opposed to 74 hours in the placebo group) and illness (2.5 days in bed as opposed to 3.5 days). The study inadvertently included patients shown subsequently to be suffering from influenza B infection; this provided an added control to the study, since no therapeutic effect was demonstrated against this infection, and amantadine is known to have no antiviral activity against *Influenza B virus*. It is suggested that rimantadine is the preferred compound, since, although not as effective as amantadine, it is less toxic (Aruda and Hayden, 1996).

Ribavirin

The structure of the synthetic nucleoside analogue 1- β -D-ribofuranosyl-1, 2,4-triazole-carboximide (ribavirin) is shown in Figure 5.4. The compound has been shown to inhibit the replication of a wide range of RNA and DNA viruses *in vitro*, including both influenza A and influenza B, and to limit influenza virus replication in mice and ferrets. The compound probably acts by inhibition of virus nucleic acid synthesis. Ribavirin is well tolerated at concentrations 200-fold greater than those necessary to inhibit virus replication; however, the compound has been reported to have immunosuppressive effects. Clinical studies have demonstrated a significant therapeutic effect on symptoms of both influenza A and B infection (Stein *et al.*, 1987); and the compound is very effective in animal studies when given by aerosol combined with rimantadine or amantadine (Hayden, 1996).

4-Guanidine-Neu5Ac 2en (GG167)

The successful development of the few antiviral compounds available has given enormous impetus to the development of further such compounds. Thus, compounds are being designed, tested and developed at the present time, and are both analogues of known antiviral compounds and novel structures (Arruda and Hayden, 1996). These initiatives are particularly important since viral strains resistant to amantadine are easily generated. One such compound to come from these initiatives is 4-guanidine-neu5Ac 2en (GG167); the structure of this compound is shown in Figure 5.4. Since antibody against NA glycoprotein of influenza virus provides partial protection against infection, and the crystal structure of NA is known (Laver *et al.*, 1984), compounds which specifically block NA activity can be designed and synthesized: GG167 is such a compound, acting on a conserved pocket of the NA of both influenza A and B viruses. The antiviral activity of GG167 can be shown *in vitro*, in animal tests and in volunteer studies (Hayden *et al.*, 1996), and it is anticipated that the compound will be licensed for use in the near future. Virus strains resistant to GG167 can occur; these have a reduced dependence on NA activity and evolve slowly (Blick *et al.*, 1995), but the observation indicates the need for further compounds in the future. Alternatively, treatment strategies using a combination of GG167

and other compounds may show synergy and reduce the chance of resistant strains arising: these studies lie in the future.

Prevention

It is clear from knowledge of the epidemics of influenza that individuals, groups and communities would benefit from the development of effective vaccines. To this end various forms of vaccines have been developed during the past 50 years: despite this, the efficacy of influenza vaccines is still questioned, and the ability of vaccines to limit epidemic infection has not been proven.

Immunity to Influenza

The antigens of the influenza virus particle which stimulate immunity to subsequent infections have been identified. The virus proteins have been purified and separately inoculated into groups of experimental animals; the results of challenge studies have indicated that immunity is induced by the host responses to the virus HA and, to a lesser extent, to the NA. Some evidence suggests that the immune response to the M2 and the NP proteins may contribute to immunity, but there is little evidence to date to suggest that these are major factors.

Studies to determine which immune responses correlate with protection against infection have indicated that the serum antibody titre against the HA is the most important; thus, susceptibility to influenza virus infection is inversely related to the titre of serum HI antibody. This is true for both experimental challenge with attenuated virus and natural infection with virulent viruses; and a serum HI titre of approximately 30–40 represents 50% protective level of antibody against infection by homologous virus (Potter and Oxford, 1979). In addition, the degree of cross-immunity for strains of virus of the same subtype is directly related to the degree of cross-reactivity of the HA antigens: immunization with influenza virus confers no protection against challenge infection with virus of a different subtype, since there is no cross-reactivity of the HAs of the two viruses. In addition to conferring relative protection against infection, serum HI antibody is reported both to reduce the severity of infection and decrease virus spreading from infected persons.

Table 5.4 Response of volunteers to immunization with whole or ether-split influenza virus vaccine and results of subsequent challenge infection

Vaccine (A/Scotland/74 + B/Hong Kong/73) ^a	Number (%) with HI titre \geq 40		Total number (%) infected by challenge virus ^b
	Preimmunization	Postimmunization	
Whole virus	7/24 (29)	18/24 (75)	3/24 (12.5)
Split virus	7/24 (29)	22/24 (92)	0/24
Saline control	6/27 (22)	6/27 (22)	11/27 (41)

^aVaccine given subcutaneously in 0.5 ml volume, and containing equivalent concentration of virus HA; control group given 0.5 ml saline only.

^b $10^{7.4}$ egg infectious dose (EID) of live virus 1 month after immunization.

Similar studies have shown that serum neuraminidase-inhibiting (NI) antibody also contributes to protection against influenza virus infection. This has been shown in studies with experimental animals and in observations of natural infections in humans. A generally held view is that the serum antibody is more important in determining immunity than the serum NI antibody. It is less clear whether other immune responses to the virus HA and NA antigens are important; local IgA antibody against virus antigens probably contributes to immunity, but the importance of cellular immune responses claimed by a number of authorities remains to be established (McMichael *et al.* 1983).

From the above, it is clear that an influenza vaccine must contain surface HA and NA antigens of the virus in a form which will stimulate serum HI and NI antibody, local IgA antibody and possibly cellular immunity. It is essential that the vaccine contains the antigens of recently isolated virus strains: although some cross-reactivity and corresponding cross-immunity are seen between viruses of the same subtype, the most solid immunity is found following immunization with virus homologous to the infecting strain. Thus, whatever the type of vaccine used, the virus content should be annually reviewed, and changed when new variants occur.

Whole Virus Vaccines

Whole, inactivated virus vaccines are prepared by inoculating the currently circulating strain of influenza virus into embryonated eggs. The allantoic fluids are harvested after 2–3 days incubation, centrifuged by zonal centrifugation to concentrate and purify the virus particles, inactivated with formalin or β -propiolactone and standardized by HA con-

tent for subcutaneous inoculation. The final inoculum is a mixture of vaccines of all the prevalent virus strains of the year. Clinical studies with vaccine prepared in this manner have recorded some local pain in approximately 20–30% of vaccinees, and systemic reactions such as fever, headache and muscle pain in about 5% of persons; however, these responses are usually mild and ephemeral. The vaccine induces serum HI and NI antibody responses which confer protection on 60–90% of volunteers against challenge virus infection (an example is shown in Table 5.4) and significant prevention of hospitalization of the elderly in subsequent epidemics. The vaccine can be given annually, each year the strains being changed to correspond to the currently circulating virus; to young and elderly; and in higher doses to the elderly who give relatively poor immune responses to conventional vaccine (Keitel *et al.*, 1996). The antibody response at a protective level for 1–5 years, depending on the vaccine virus strain and the age of the vaccinees; however, subsequent infecting virus strains may show antigenic drift, and the vaccine-induced antibody will be less effective in protecting against these new strains. In contrast, the antibody response to a vaccine containing virus of a new subtype against which the vaccinees have had no past experience is relatively short lived, and 60–80% of the antibody titre may have disappeared by 12 months after immunization.

Split Virus Vaccines

Because of the relatively high incidence of reactions seen in vaccinees given whole, inactivated virus vaccine, attempts have been made to produce a product which is less reactogenic while preserving the ability to induce satisfactory titres of serum anti-

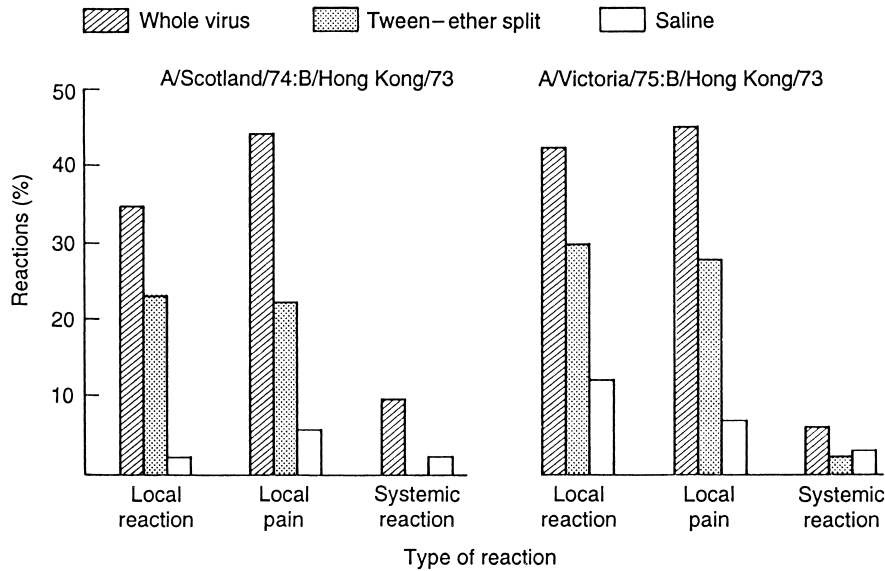

Figure 5.5 Reactions of volunteers to immunization with influenza virus vaccines. (See also Table 5.4)

body. For this, virus pools grown, purified and inactivated as described in the previous section are treated with detergents to disrupt the virus particles: inoculation of virus manufactured in this manner induces fewer reactions in volunteers than whole virus vaccine (Figure 5.5), and the serum antibody responses and protection afforded against subsequent challenge are similar (Table 5.4). For these reasons, many prefer split vaccines to whole virus vaccines.

Subunit Virus Vaccines

Since only virus HA and NA antigens are required to induce immunity, vaccines containing purified surface antigens and free of virus RNA and core proteins have been investigated; these are used in aqueous suspension, or may be adsorbed to carriers such as cholera B toxin, ISCOMs, or with immune modulators, such as IL-2. These adjuvant subunit vaccines confer protection when given early to experimental animals (Scheefers and Becht, 1994; Katz *et al.*, 1997), but this has not been tested in humans: a review of adjuvants for human vaccine by Gupta and Siber (1995) extends this subject. Volunteers given aqueous subunit vaccines intramuscularly experience fewer reactions than those given whole virus vaccines or adsorbed subunit vaccine (Figure 5.6). In years of antigenic drift when the population is primed, the serum HI antibody re-

sponse to whole, subunit-adsorbed or aqueous subunit vaccines is similar; and since aqueous vaccines are less reactogenic, these are to be preferred (Table 5.5). However, when the population has not been primed by previous exposure to viruses of the same subtype, the serum HI antibody response to whole virus is significantly greater than for subunit vaccine (Table 5.5). But at these times, two doses of whole virus vaccine are needed: since satisfactory levels of antibody can be induced with two doses of either whole or subunit vaccines, and the latter are less reactogenic, these are again preferred.

It must be mentioned that attempts to increase the immunogenicity of virus vaccine for humans by incorporating adjuvants have not to date identified a safe and suitable carrier. The best vaccines available at the moment are aqueous subunit vaccines; but many authorities hold that these are not sufficiently potent for completely successful immunization, and further developments are needed (Potter, 1982).

Live Virus Vaccines

There is evidence that immunization with live, attenuated influenza virus vaccines induces a more solid immunity than inactivated vaccines. These findings, the known shortcomings of inactivated vaccines, the resistance of general practitioners and the public to immunization against influenza by

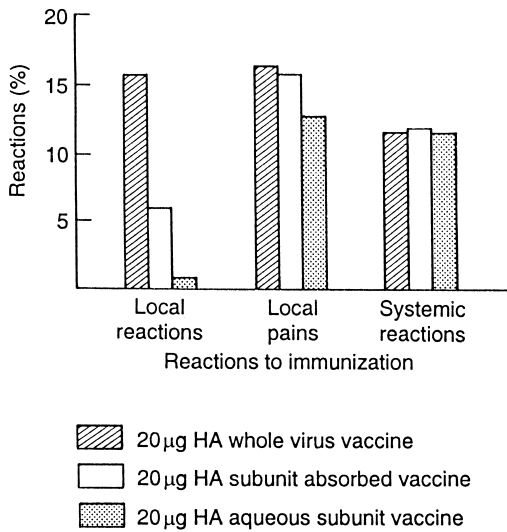

Figure 5.6 Reactions of volunteers to immunization with influenza virus vaccines

injection and the reactogenicity to inactivated virus vaccines have continued to encourage the development of live vaccines against this infection. Influenza viruses can be attenuated by serial passage in embryonated eggs, by chemical mutation or by laboratory passage at reduced temperatures; using these techniques virus can be produced which infects volunteers without producing appreciable clinical illness. Unfortunately, these methods require a long and unpredictable time to complete—probably too long for vaccine to be available for immunization against current influenza variants. To circumvent this problem, attenuated strains produced by one of the above methods have been mixed with wild-type virus to produce reassortants which contain the RNA fragments coding for wild-type HA and NA, and all the other genetic material from the attenuated strain. These recombinants can be produced relatively quickly in the laboratory and, when inoculated intranasally into volunteers, produce few and mild symptoms, induce both serum and local HI and NI antibody against the wild-type virus and immunity to challenge virus infection (Beare, 1982). One attenuated strain, A/Ann Arbor/6/60 (H2N2) has been used to produce attenuated vaccine reassortants for over two decades (Maassab and DeBorde, 1985); and in all studies these have been shown to be safe and effective, easily administered and suitable for all ages (Potter, 1994).

Some problems in the development of live attenuated influenza virus vaccines have not been

overcome. The development of a suitable influenza virus vaccine initially involves the production and purification of a suitable reassortant. Then, under strictly controlled conditions, the virus must be shown to be attenuated for humans and to be genetically stable, since some vaccine virus strains in the past have been found to revert to virulent variants when inoculated into volunteers. In a series of developmental tests the vaccine virus must be shown to be attenuated for various groups of volunteers of different ages and susceptibility, to induce antibody responses, and to protect against challenge virus infection before it can be licensed for general use. At the present time these studies are estimated to take approximately 2 years to complete: this makes their development impractical, since by the time the vaccine can be made available, the epidemic strain against which it has been prepared will probably have disappeared, to be replaced by new strains requiring a new vaccine. Despite these setbacks, studies are continuing to find methods for the more rapid development of live vaccine; should a method be found that reduces the development period to 6–9 months, live influenza virus vaccines, with all the attendant advantages, will become practical. Alternatively, if the long history of efficacy and safety of reassortant vaccine virus based on A/Ann Arbor/6/60 (H2N2) can be accepted, many of the protracted studies on safety listed above may be considered unnecessary and the development of these vaccines accelerated. No live influenza virus vaccines are available for general use in Western countries at the present time, and vaccines are limited to one of the forms of inactivated vaccines discussed above.

Other Approaches to Vaccine Development

In addition to the development of recombinant influenza virus as vaccines, several other approaches are possible, and are being researched at the present time. The gene coding for the HA glycoprotein can be cloned into a variety of vehicles, such as baculovirus, by genetic engineering, and can be induced to express virus HA; large quantities of pure virus HA can be produced for immunization by these techniques. Recent studies have shown that a DNA copy of the virus RNA gene coding to virus HA can be cloned into *Vaccinia virus*; immunization with this material induced serum HI antibody and cellular immunity to the virus HA. Fears that

Table 5.5 Response of volunteers to immunization with inactivated influenza vaccines

Previous experience ^a	Nature of influenza A (H1M1) vaccine given	Percentage with serum HI titres \geq 40 and geometric mean titre (in parentheses)		
		Preimmunization	Postimmunization	
			1 dose	2 doses
Primed	Whole virus	20 (13)	95 (465)	—
	Subunit—absorbed	32 (19)	100 (578)	—
	Subunit—aqueous	33 (10)	100 (622)	—
Unprimed	Whole virus	0	77 (70)	96 (259)
	Subunit—absorbed	0	50 (27)	88 (176)
	Subunit—aqueous	0	25 (14)	94 (99)

^aOlder subjects who had been exposed to influenza A (H1N1) viruses in 1933–1957 (primed) and subjects born after 1957 (unprimed).

Number of subjects in each group varied from 12 to 30.

Vaccinia virus is too dangerous a vector for immunization of humans against influenza are based on reactions of vaccinees to this virus when used in the past for immunization against smallpox; however, it is suggested that the above virus construct is less pathogenic than native *Vaccinia virus*. Again, cDNA derived from virus RNA can be selectively mutated and then rescued from transfected cells with helper virus (Parkin *et al.*, 1996): these deletion mutants cannot revert to virulent virus and are therefore safe, attenuated vaccines. Vaccines can be constructed as DNA plasmids containing the DNA copy of the virus RNA coding for the virus HA (Ulmer *et al.*, 1996): these species induce serum antibody and cellular immunity and protection in animal studies, and are of great current interest. Finally, immunization with NA antigen has been proposed: antibody to the NA would permit subsequent infection by wild-type virus; however, this infection would not cause clinical illness, but would induce immunity comparable to that following natural infection (Couch *et al.*, 1974). This strategy has proved successful against influenza in chickens.

Recommendations

At the present time, no live attenuated influenza virus vaccine is available for general use, and the new and novel methods of producing vaccine outlined above remain a hope for the future. The currently available vaccines are inactivated virus vaccines produced from virus grown in eggs. Of these, the most acceptable are the aqueous subunit vaccines, which are replacing the earlier whole and split virus vaccines. These vaccines produce relatively

few reactions, and such reactions are usually mild and of relatively short duration; they produce serum antibody in the majority of subjects, and immunity to infection in 60–90% of vaccinees. Vaccine is recommended for elderly and ‘at risk’ persons for whom influenza is a threat to life. In addition, key personnel of industry and social services should be offered vaccine, particularly when new subtypes emerge. For the remainder of the population, immunization against influenza is a debatable subject: some authorities hold that vaccines should be available for all and used according to the wishes of doctors and patients, while others protest that the widespread use of vaccine is not justified.

REFERENCES

- Arruda, E. and Hayden, F.G. (1996) Update on therapy of influenza and rhinovirus infections. *Antiviral Chemotherapy*, **4**, 175–187.
- Beare, A.S. (ed.) (1982) Research into immunization of humans against influenza by means of living viruses. In *Basic and Applied Influenza Research*, pp 211–234. CRC Press, Boca Raton FL.
- Blick, T.J., Tiong, T., Sahasrabudhe, A. *et al.* (1995) Generation and characterization of an influenza virus neuraminidase variant with decreased sensitivity to the neuraminidase inhibitor 4-guanidine-neu 5 AC 2 en. *Virology*, **214**, 475–484.
- Blok, V., Cianci, C., Tibbles, K.W. *et al.* (1996) Inhibition of the influenza virus RNA-dependant RNA polymerase by antisera directed against the carboxy-terminal region of the PB2 subunit. *Journal of General Virology*, **77**, 1025–1033.
- Brumback, B.G. and Wade, C.D. (1996) Simultaneous rapid culture for four respiratory viruses in the same cell monolayer using a differential multicoloured fluorescent confirmatory stain. *Journal of Clinical Microbiology*, **34**, 798–801.
- Conover, R.T. and Roessmann, U. (1990) Malformation complex

- in an infant with intrauterine influenza viral infection. *Archives of Pathology and Laboratory Medicine*, **114**, 535.
- Corey, L., Rubin, R.J., Hattwick, M.A.W. *et al.* (1976) A nationwide outbreak of Reye's syndrome. *American Journal of Medicine*, **61**, 615–625.
- Couch, R.B., Kasel, J.A., Gerin, J.L. *et al.* (1974) Induction of partial immunity to influenza by a neuraminidase-specific vaccine. *Journal of Infectious Diseases*, **129**, 411–420.
- Crosby, A.W. (1976) *Epidemic and Peace, 1918*. Greenwood Press, Westford CT.
- Dolin, R., Reichman, R.C., Madore, P. *et al.* (1982) A controlled trial of amantadine and rimantadine in the prophylaxis of influenza A infection. *New England Journal of Medicine*, **307**, 580–584.
- Francis, T. Jr, Davenport, F.M. and Hennessy, A.V. (1953) A serological recapitulation of human infection with different strains of influenza virus. *Transactions of the Association of American Physicians*, **66**, 231–239.
- Gupta, R.K. and Siber G.R. (1995) Adjuvants for human vaccines—current status, problems and future prospects. *Vaccine*, **13**, 1263–1276.
- Hayden, F.G. (1996) Combination antiviral therapy for respiratory virus infections. *Antiviral Research*, **29**, 45–48.
- Hayden, F.G., Treanor, J.J., Betts, R.F. *et al.* (1996) Safety and efficacy of the neuraminidase inhibitor GG167 in experimental human influenza. *JAMA*, **275**, 295–299.
- Hite, S.A. and Huang, Y.T. (1996) Microwave-accelerated direct immunofluorescent staining for respiratory syncytial virus and influenza A virus. *Journal of Clinical Microbiology*, **34**, 1819–1820.
- Katz, J.M., Lu, X., Young, S.A. *et al.* (1997) Adjuvant activity of the heat stable enterotoxin from enterotoxigenic *Escherichia coli* for oral immunisation of inactivated influenza vaccine. *Journal of Infectious Diseases*, **175**, 352–363.
- Kawaoka, T., Yamnikova, S., Chambers, T.M. *et al.* (1990) Molecular characterisation of new haemagglutinin, subtype H14, of influenza A virus. *Virology*, **179**, 559–567.
- Keitel, W.A., Cate, T.R., Atmar, R.L. *et al.* (1996) Increasing doses of purified influenza virus haemagglutinin and sub-virus vaccines enhance antibody responses in the elderly. *Clinical and Diagnostic Laboratory Immunology*, **3**, 507–510.
- Krug, R.M. (1983) Transcription and replication of influenza viruses. In *Genetics of Influenza Viruses*. (eds P. Palese and D.W. Springer), pp 70–92. Springer-Verlag, Vienna.
- Lamb, R.A., Holsinger, L.J. and Pinto, L.H. (1994) The Influenza virus M2 ion channel and its role in the influenza virus life cycle. In *Cellular Receptors of Animal Viruses* (ed. E. Wimmer), pp 303–318. Cold Spring Harbor Laboratory Press, Cold Spring Harbor NY.
- Laver, W.G., Colman, P.M., Ward, C.W. *et al.* (1984) Influenza virus neuraminidase: structure and variation. In *The Molecular Biology and Epidemiology of Influenza* (eds C.H. Stuart-Harris and C.W. Potter), pp 77–89, Academic Press, London.
- Lin, T.-I., Heider, J. and Schroeder, C. (1997) Different modes of inhibition by amantadine and acemide derivatives and natural polyamines of the functionally reconstituted influenza M2 proton channel protein. *Journal of General Virology*, **78**, 767–774.
- Liu, C., Eichelberger, M.C., Compans, R.W. *et al.* (1995) Influenza type A virus neuraminidase does not play a role in viral entry replication, assembly or budding. *Journal of Virology*, **69**, 1099–1106.
- Lynberg, M.C., Khovry, M.J., Lu, X. *et al.* (1994) Maternal flu, and the risk of neural tube defects: a population-based case-control study. *American Journal of Epidemiology*, **140**, 244–255.
- Maassab, H.F. and DeBorde, D.C. (1985) Development and characterization of cold-adapted viruses for use as live virus vaccines. *Vaccine*, **3**, 355–369.
- McMichael, A.J., Gotch, F.M., Noble, G.R. *et al.* (1983) Cytotoxic T-cell immunity to influenza. *New England Journal of Medicine*, **309**, 13–17.
- Martin, K. and Helenius, A. (1991) Transport of incoming influenza virus nucleocapsid into nucleus. *Journal of Virology*, **65**, 232–244.
- Mori, I., Nagafuji, H., Matsumoto, K. *et al.* (1997) Use of the polymerase chain reaction for demonstration of influenza virus dissemination in children. *Clinical Infectious Diseases*, **24**, 736–737.
- O'Callaghan, E. (1991) Schizophrenia after post-prenatal exposure to 1957 H2-influenza epidemic. *Lancet*, **337**, 1248–1250.
- Parkin, N.T., Chu, P. and Coeling, H. (1996) Temperature sensitive mutants of influenza A virus generated by reverse genetics and clustered charged to alanine mutagenesis. *Virus Research*, **46**, 31–44.
- Potter, C.W. (1982) Inactivated influenza virus vaccine. In: *Basic and Applied Influenza Research* (ed. A.S. Beare), pp 119–159. CRC Press, Boca Raton FL.
- Potter, C.W. (1994) Attenuated influenza virus vaccines. *Reviews in Medical Virology*, **4**, 279–292.
- Potter, C.W. and Oxford, J.S. (1977) Animal models of influenza virus infection as applied to the investigation of antiviral compounds. In *Chemoprophylaxis and Virus Infection of the Respiratory Tract*, vol. 2. (ed. J.S. Oxford), pp 1–26. CRC Press, Boca Raton FL.
- Potter, C.W. and Oxford, J.S. (1979) Determinants of immunity to influenza infection in man. *British Medical Bulletin*, **35**, 69–75.
- Reye, R.D.K., Morgan, C. and Baral, J. (1963) Encephalopathy and fatty degeneration of the viscera: a disease entity in childhood. *Lancet*, **ii**, 749–752.
- Richardson, J.C. (1991) NS2 protein of influenza virus is found in purified virus and phosphorylates in infected cells. *Archives of Virology*, **116**, 69–80.
- Rohm, C., Zhou, N., Suss, J. *et al.* (1996) Characterization of a novel influenza haemagglutinin, H15: criteria for determination of influenza A subtypes. *Virology*, **217**, 508–516.
- Scheefers, K. and Becht, H. (1994) Protection of mice against an influenza infection by oral vaccination with viral nucleoprotein incorporated into immunostimulatory complexes. *Medical Microbiology and Immunology*, **183**, 265–275.
- Skehel, J.J., Daniels, R.S., Douglas A.R. *et al.* (1984) Studies on the haemagglutinin. In *The Molecular Biology and Epidemiology of Influenza* (eds C.H. Stuart-Harris and C.W. Potter), pp 61–68. Academic Press, London.
- Stein, D.S., Creticos, C.M., Jackson, G.G. *et al.* (1987) Oral ribavirin treatment of influenza A and B. *Antimicrobial Agents and Chemotherapy*, **31**, 1285–1287.
- Stuart-Harris, C.H. (1979) Epidemiology of influenza in man. *British Medical Bulletin*, **35**, 3–8.
- Stuart-Harris, C.H., Schild, G.C. and Oxford, J.S. (1985) *Influenza: The Viruses and the Disease*, pp 22–40. Edward Arnold, London.

- Tashiro, M., Ciborowski, P., Klenk, H.-D. *et al.* (1987) role of *Staphylococcus aureus* in the development of influenza pneumonia. *Nature (London)*, **325**, 536–537.
- Taubenberger, J.K., Reid, A.H., Krafft, A.E. *et al.* (1997) Initial genetic characterisation of the 1918 'Spanish influenza virus'. *Science*, **275**, 1793–1796.
- Ulmer, J.B., Deck, R.R., Yawman, A.Y. *et al.* (1996) DNA vaccines for bacteria and viruses. In "Novel Strategies in Design and Production of Vaccines" (eds S. Cohen and A. Shafferman) pp 49–53. Plenum Press, New York.
- Uryvaev, L.V., Rusavskaia, E.A., Sinagutullina, N.M. *et al.* (1990) Detection of influenza A virus RNA by molecular hybridisation of nucleic acids using biotin treated probes. *Voprosy Virusologii*, **35**, 464–466.
- Wright, K.E., Wilson, G.A.R., Noudsad, D. *et al.* (1995) Typing and subtyping of influenza viruses in clinical samples by PCR. *Journal of Clinical Microbiology*, **33**, 1180–1184.
- Zhang, W.D. and Evans, D.H. (1991) Detection and identification of human influenza virus by the polymerase chain reaction. *Journal of Virological Methods*, **33**, 165–189.
- Zink, P., Drescher, J., Verhagen, W. *et al.* (1987) Serological evidence of recent influenza A (H3N2) infections in forensic cases of sudden infant death syndrome (SIDS). *Archives of Virology*, **93**, 223–232.

Parainfluenza Viruses

Donald M. McLean

University of British Columbia, Vancouver, Canada

INTRODUCTION

Parainfluenza viruses were first isolated from nasopharyngeal secretions of North American children with croup and other acute respiratory infections during the mid-1950s, through the widespread application of tissue culture techniques augmented by haemadsorption. Currently they cause a significant proportion of acute respiratory infections of children in the temperate zones of both hemispheres during the cooler months of each year (McLean, 1988).

enveloped particles, 120–300 nm in total diameter (Figure 6.1). They contain helically symmetrical nucleocapsid strands 12–17 nm in diameter, with cross-striations at intervals of 4 nm to give a herringbone appearance (McLean and Wong, 1984). Viral envelopes (coats) of the genus *Respirovirus* contain glycoprotein surface projections 8 nm long, spaced 8–10 nm apart, some of which function both as haemagglutinin (HA) and as neuraminidase (NA) and others perform cell fusion (F) functions.

THE VIRUSES

Taxonomy

Parainfluenza viruses are classified within the genus *Respirovirus* (paramyxovirus group) of the family *Paramyxoviridae* (Francki *et al.*, 1991). Human pathogens comprise six species (serotypes) including parainfluenza 1, parainfluenza 2, parainfluenza 3, parainfluenza 4 (subtypes 4a, 4b), mumps and *Newcastle disease virus*. An additional five unrelated serotypes have been isolated from a variety of birds and mammals, but they are not pathogenic for humans.

Morphology

The virions are pleomorphic but roughly spherical

Molecular Aspects

Each virus particle contains one molecule of single-stranded ribonucleic acid (ssRNA), molecular weight $5-7 \times 10^6$, which accounts for 0.5 per cent by weight of the virus particle. Most particles contain negative-sense strands of RNA, but some contain positive-sense strands. (Positive-sense RNA serves directly as messenger RNA, specifying information for the synthesis of structural and non-structural proteins. Negative-sense RNA cannot serve as a messenger, but a virion transcriptase initiates transcription into 5–8 complementary messenger positive-sense RNA strands.) Particles contain six polypeptides of molecular weights 35–200K, including three proteins, NP, P and L, in nucleocapsids, together with an additional three in viral envelopes: M (matrix) protein plus two glycoproteins located on spikes comprising haemagglutinin neuraminidase (HN) and fusion (F). Their genomic determinants are arranged in sequence

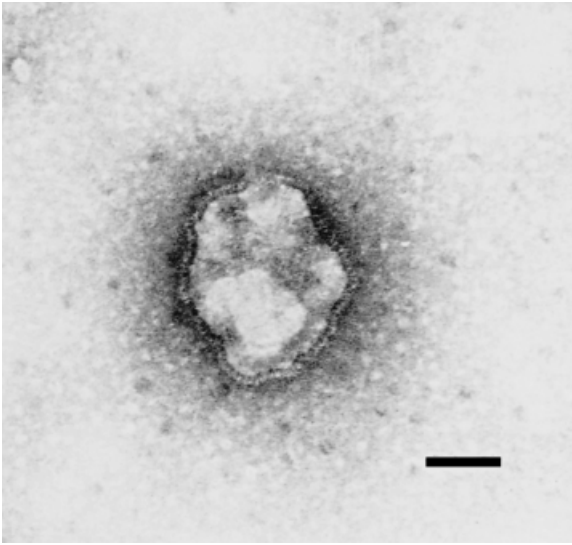

Figure 6.1 Parainfluenza 1 virion in nasopharyngeal secretions from a boy aged 11 months with bronchiolitis. (Original magnification $\times 193\,050$) (Reproduced with permission from McLean, D.M. and Wong, K.K. (1984) *Same-day Diagnosis of Human Virus Infections*, p. 73, CRC Press, Boca Raton FL, © CRC Press Inc)

from the 3' end thus: NP-P-F-M-HN-L (Heilman, 1990). The haemagglutinin component of HN glycoprotein (68K) induces haemagglutination of mammalian erythrocytes through attachment to mucoprotein receptors containing *N*-acetylneuraminic (sialic) acid located on cell membranes, but this bond may be disrupted by neuraminidase after prolonged contact, thus inducing elution. Fusion (F) glycoprotein (54K) effects fusion between viral envelopes and host cell membranes, thus permitting entry of viral genome into the host cell at commencement of viral replication. Lipids, mainly host-cell derived, comprise 20–25% by weight of virus particles; carbohydrates comprise 6%. The total molecular weight of virions is at least 500×10^6 and their density in sucrose is $1.18\text{--}1.20 \text{ g mL}^{-1}$, with an S_{20W} of at least 1000. Virions are sensitive to lipid solvents, non-ionic detergents, formaldehyde and oxidizing agents.

Virus particles enter host cells by fusion of the envelope with the cell surface; the nucleocapsid is the functional template for transcription of complementary viral mRNA species and for RNA replication; independently assembled nucleocapsids are enveloped at the cell surface at sites containing virus

envelope proteins. After replication within the cytoplasm, mature virus particles are released by budding.

Inhibitors of protein synthesis block viral genome replication but not transcription, and carbohydrate analogues interfere with glycosylation of virion proteins. Inhibitors of DNA replication or transcription have no direct effects on parainfluenza virus replication.

Biological Properties

Parainfluenza viruses multiply readily in primary monolayer tissue cultures of rhesus or cynomolgus monkey kidney cells after incubation at $35\text{--}37^\circ\text{C}$. After 3–7 days incubation, haemadsorption can be demonstrated readily by removing the supernatant fluids (which contains virus at high titre) and adding a suspension (0.1%) of guinea pig erythrocytes in 0.15 mol L^{-1} saline (Figure 6.2). Many strains agglutinate chick erythrocytes, often at a lower titre than guinea-pig erythrocytes. Cytopathic effects are not regularly observed following multiplication of parainfluenza type 1, 3 or 4 viruses, but syncytia are induced following growth of parainfluenza 2 and the Sendai strain of parainfluenza 1. Cytoplasmic inclusions have been described after parainfluenza virus replication. A variety of continuous polyploid human tissue culture cells have supported multiplication of some strains of parainfluenza virus. Laboratory animals do not exhibit illness after inoculation of parainfluenza viruses intranasally or by other routes, except in the following two instances: (1) parainfluenza 1 (Sendai strain) induces pneumonia in rodents; and (2) parainfluenza 3 (shipping fever strain) induces respiratory infections in calves.

Prototypes

Parainfluenza 1 virus, initially termed haemadsorption type 2 virus, was first isolated from a throat swab of a boy aged 3 years with acute laryngotracheobronchitis (croup or 'tracheitis') in Washington DC during 1957. It was found subsequently to be antigenically identical with the Sendai strain, first isolated from the lung of a fatal case of newborn pneumonitis in Sendai, Japan, in 1952. Parainfluenza 2 virus was first isolated from nasopharyn-

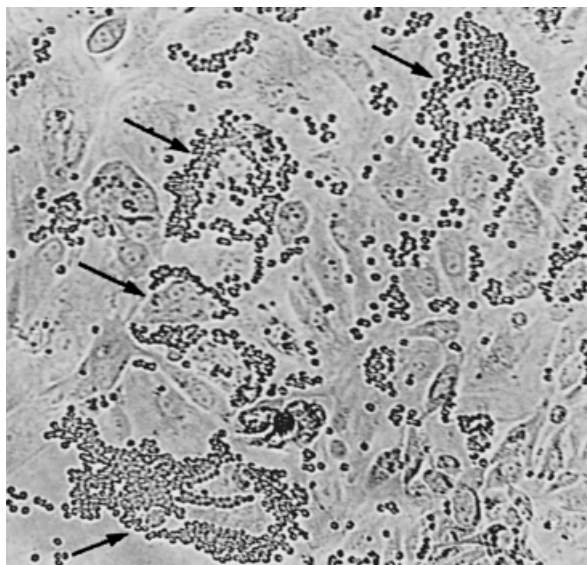

Figure 6.2 Haemadsorption following growth of parainfluenza 3 virus in primary monolayer tissue culture of monkey kidney cells. (Unstained; original magnification $\times 100$). Arrows indicate adsorption of guinea-pig erythrocytes to infected tissue culture cells. (Reproduced with permission from Swain, R.H.A. and Dodds, T.C. (1967) *Clinical Virology*, p157, Livingstone, Edinburgh)

geal secretions of an infant aged 11 months with croup in Cincinnati, Ohio, during 1955. Parainfluenza 3 virus, initially termed haemadsorption type 1 virus, was first isolated from an infant with pneumonia in Washington DC during 1957, in the same outbreak of wintertime respiratory infection from which parainfluenza 1 virus was recovered. Bovine strains of parainfluenza 3 virus were first isolated from calves with a respiratory disease termed shipping fever in Maryland during 1958, and they have been recovered during subsequent outbreaks of shipping fever. Parainfluenza 4a virus was first isolated from the throat swab of a college student with mild upper respiratory tract illness in Washington DC during 1958. Parainfluenza 4b virus was first isolated from the respiratory tract of a child in Washington DC during 1962. Both these parainfluenza 4 subtypes have been isolated relatively infrequently in subsequent years.

Immunological Aspects

Antibodies detectable by haemagglutination inhibition (HI) appear in sera 1–2 weeks after infection

with parainfluenza viruses and they persist for at least several years. However, antibody production in infants aged less than 2 years may sometimes be delayed until they have sustained recurrent parainfluenza infections; this correlates well with clinical observations. Neutralizing antibodies appear simultaneously with HI antibodies. Complement-fixing antibodies against the whole virion (V-CF) appear 2–3 weeks after infection and persist for 1 or more years. Before measuring HI antibody, it is essential to remove two categories of non-specific inhibitor from serum. A heat-labile inhibitor is destroyed by heating at 56°C for 30 minutes and a heat-stable mucoprotein inhibitor can be inactivated either by treatment with $m/100$ potassium periodate at 22°C for 30 minutes or by treatment overnight at 37°C with neuraminidase (receptor-destroying enzyme). Technical details of antibody titrations and pre-treatment of sera are described in a textbook on techniques (McLean, 1982).

PATHOGENESIS

Parainfluenza viruses enter new susceptible hosts by inhalation of virus-laden droplet nuclei which are expelled into the air from the mouths or noses of infected patients. Virus multiplication occurs throughout the tracheobronchial tree, inducing catarrhal inflammation with excessive production of mucus. The aryepiglottic folds (vocal cords) of the larynx become grossly swollen, causing obstruction to the inflow of air, which is manifested by inspiratory stridor and indrawing of the soft tissues around the rib cage. Infection does not regularly spread beyond the respiratory tract.

CLINICAL FEATURES

Symptomatology

Croup, also termed acute laryngotracheobronchitis, is the commonest clinical manifestation of infection with parainfluenza viruses in children (Parrott *et al.*, 1962; Banatvala *et al.*, 1964; McLean, 1988; Reed *et al.*, 1997). Typical clinical features include croupy cough, inspiratory stridor, hoarse voice or cry, respiratory difficulty on inspiration, and indrawing of the chest wall in the subcostal, intercos-

tal or supraclavicular areas. About 80% of patients exhibit a cough and runny nose 1–3 days before onset of croup. Patients are usually afebrile. Although inspiratory rhonchi are heard frequently throughout the lung fields, there are no rales and the breath sounds are diminished consistent with the reduced air entry into the chest. Radiological examination may reveal diminished inflation of the lungs. Occasionally the epiglottis is grossly swollen and reddened (epiglottitis), due to infection by either parainfluenza viruses or *Haemophilus influenzae* type b. Severe airway obstruction, arising from gross swelling of the epiglottis or the aryepiglottic folds of the larynx, may necessitate emergency tracheotomy to restore an adequate airway. Hospitalized patients are usually admitted within 3–24 hours after onset of croup, when they are placed promptly into plastic tents supplied with cooled humidified oxygen ('croupettes'). Usually respiratory symptoms subside within 1–2 days. Children aged less than 3 years may experience recurrent attacks with the same serotype of parainfluenza virus due to a combination of narrow diameters throughout the larynx, trachea and bronchi, plus ineffective production of antibody.

Parainfluenza viruses are found uncommonly in association with other respiratory tract infections in children such as tracheobronchitis (deep cough and rhonchi), bronchiolitis and bronchopneumonia; these syndromes arise frequently from respiratory syncytial virus infection (Chapman *et al.*, 1981; McLean, 1988). Conversely, viruses apart from the parainfluenza viruses, such as influenza, measles and chickenpox, which induce catarrhal inflammation throughout the tracheo-bronchial tree, may occasionally induce croup. Some parainfluenza virus infections may be devoid of specific clinical features. For example, at an orphanage in Tennessee during the winter of 1960, parainfluenza 3 virus was isolated from 10 of 151 children, yet rhinorrhoea and mild fever affected both virus-positive and virus-negative individuals to the same extent (Rendtorff *et al.*, 1963). Similarly, in a Washington DC children's shelter, where mild febrile respiratory illnesses among inmates were common, clear-cut association with parainfluenza virus infection was difficult to determine clinically, but spread of virus through the institution was established by virus isolations achieved from throat swabs collected routinely thrice weekly (Parrott *et al.*, 1962).

Parainfluenza virus infections in adults are rela-

tively uncommon, and symptoms are usually less severe in adults than in children. In two family practices in Cambridge, England, adults developed illness resembling influenza from virologically confirmed parainfluenza infections (Banatvala *et al.*, 1964), and similar influenza-like syndromes have afflicted military recruits in the USA (McKinney *et al.*, 1959; Dick *et al.*, 1961) and task-force personnel in the Antarctic (Parkinson *et al.*, 1979).

Epidemiology

Parainfluenza Viruses in Children with Croup

Parainfluenza viruses show high prevalence rates during annual wintertime outbreaks of respiratory tract infections, especially croup, in children throughout the temperate zones of the northern and southern hemispheres (Parrott *et al.*, 1962; McLean *et al.*, 1963, 1967; Gardner *et al.*, 1971; Foy *et al.*, 1973; Chapman *et al.*, 1981; Fairfield Hospital, 1982; Reed *et al.*, 1997). For example, in Toronto between November 1960 and March 1963, when 794 hospitalized paediatric patients with croup were examined virologically, parainfluenza 1 virus was isolated from 30.3% and parainfluenza 3 from 3.5% (Table 6.1). The peak monthly incidence rate of 72 per cent for isolation of parainfluenza 1 virus was achieved during November 1962 (McLean *et al.*, 1963). Overall rates of 43.9% for parainfluenza 1 virus isolations and 5.5% for parainfluenza 3 were observed during October through February 1964–1965 and 1966–1967, with a peak rate of 60.0% for parainfluenza 1 in January 1967 (McLean *et al.*, 1967). Influenza A and B viruses were isolated relatively infrequently from croupy patients, despite waves of epidemic prevalence in communities where they caused high attack rates of clinically typical influenza among adults. Comparable patterns of association between the parainfluenza viruses, especially type 1 and croup, have been demonstrated among hospitalized patients in Newcastle upon Tyne, England, Washington DC, and Melbourne, Australia, and in ambulatory plus hospitalized children in Seattle, Washington, and Chapel Hill, North Carolina (Table 6.1). In all these centres, respiratory syncytial virus was found relatively infrequently in croupy patients. Croupy patients from whom parainfluenza viruses have been

Table 6.1 Virus isolation rates from patients with croup

Serotype	Percentage virus isolations from patients							
	Toronto		Newcastle ^c 1969–70	Washington ^d 1957–61	Melbourne ^e		Seattle ^f 1966–71	Chapel Hill ^g 1966–75
	1960–63 ^a	1964–67 ^b			'81–'82	'85–'86		
Parainfluenza 1	30.3	43.9	19.1	20.0	12.7	12.9	12.9	67.3*
Parainfluenza 2	0.5	—	10.6	4.4	18.2	9.2	1.4	*
Parainfluenza 3	3.5	5.5	5.3	4.4	6.3	1.8	2.9	*
Influenza A	0.4	0.3	3.2	—	0.9	5.5	1.0	4.6
Influenza B	1.1	1.3	—	—	0.9	1.8	1.0	2.8
Respiratory syncytial	—	—	10.6	—	7.3	3.7	1.0	9.6
Other viruses	—	—	6.4	—	0.9	1.8	7.2	5.5
Total positive (%)	35.9	51.0	55.3	28.6	47.2	36.7	29.8	35.4
Total cases tested	794	380	94	206	110	54	210	793

*Represents 189 strains of parainfluenza types 1, 2 and 3; proportions of each were not stated.

^aMcLean *et al.* (1963); ^bMcLean *et al.* (1967); ^cGardner *et al.* (1971); ^dParrott *et al.* (1962); ^eFairfield Hospital (1982, 1986); ^fFoy *et al.* (1973); ^gChapman *et al.* (1981).

Table 6.2 Parainfluenza virus isolates from children with acute lower respiratory infections

Virus	Location	Percentage virus isolation in each clinical category			
		Croup	Tracheobronchitis	Bronchiolitis	Pneumonia
Parainfluenza 1	Newcastle 1969–70 ^a	19.1	1.5	2.1	1.1
	Washington 1957–61 ^b	20.0	1.0	1.0	0.6
	Seattle 1966–71 ^c	12.9	—	2.6	0.2
	Chapel Hill 1969–75 ^d	23.8*	5.9	5.5	20.0
Parainfluenza 2	Newcastle	10.6	0	0	0
	Washington	4.4	0.4	0.3	0.1
	Seattle	1.4	—	1.3	0
	Chapel Hill	*	*	*	*
Parainfluenza 3	Newcastle	5.3	2.7	6.4	3.2
	Washington	4.4	2.0	4.0	1.6
	Seattle	1.4	—	1.3	1.1
	Chapel Hill	*	*	*	*
Respiratory syncytial	Newcastle	10.6	†	40.8†	†
	Washington 1959–61 ^e	3.0	2.0	25.0	10.0
	Seattle	1.0	—	9.8	2.3
	Chapel Hill	3.4	4.7	7.5	26.1

*Serotypes were not stated in the publication.

†Overall RSV isolated rate from respiratory infections other than croup.

^aGardner *et al.* (1971); ^bParrott *et al.* (1962); ^cFoy *et al.* (1973); ^dChapman *et al.* (1981); ^eChanock *et al.* (1962).

isolated have shown rising antibody titres against the homologous serotype during convalescence, which confirms that virus infection occurred at the time of illness.

A strong association between parainfluenza viruses and croup, but infrequent isolations of parainfluenza viruses from other lower respiratory tract infections, is demonstrated clearly in hospitalized patients at Newcastle upon Tyne and Washington DC, and in ambulatory patients in Seattle and Chapel Hill (Table 6.2). This association was con-

firmed among otherwise healthy children aged under 5 years in Nashville, Tennessee, between 1974 and 1993 (Reed *et al.*, 1997). Conversely, respiratory syncytial virus, which is a major aetiological agent in bronchiolitis and pneumonia, is found in a relatively small proportion (1.0–10.6%) of croupy patients.

Highest age-specific attack rates for croup were observed regularly in children aged less than 3 years, both in the above centres and elsewhere. Highest parainfluenza virus isolation rates were ob-

served in that age group. For example, in Toronto between November 1962 and March 1963, parainfluenza viruses were isolated from 92 of 224 croupy children and influenza A from an additional three children (total rate 42%). Of the 166 children aged less than 3 years, 46% yielded viruses, and, of the 58 children older than 3 years, 33% yielded viruses (McLean *et al.*, 1963).

Parainfluenza 1 and parainfluenza 3 viruses have been isolated virtually in every month of the year, when routine surveillance is pursued for three or more years. In Toronto, these serotypes were isolated during every month except June and July, and similar observations have been recorded from centres including Washington DC, Seattle and Nashville. However, in each location, abrupt increases in monthly virus isolation rates, accompanied by substantially increased clinical attack rates of croup, occur either early or late in the winter season, between October and February in the northern hemisphere and the corresponding winter months April through August in the southern hemisphere. Frequently, parainfluenza infections associated with croup precede, by several weeks, an increase in incidence of respiratory syncytial virus infections inducing bronchiolitis and pneumonia. However, in some localities during particular years, both categories of paramyxovirus may circulate simultaneously.

Parainfluenza 1 neutralizing antibodies have been found in sera from 48% of infants aged 0–5 months at a Washington DC shelter, which declined to 4% at 6–12 months (Parrott *et al.*, 1962). Antibody rates increased steadily with advancing age to 74% among children aged > 4 years (Figure 6.3). Comparable trends were observed for neutralizing antibodies to parainfluenza 2 and parainfluenza 3 viruses, but in each age category the highest antibody acquisition rates were against parainfluenza 3. Antibodies during the initial 5 months of life were acquired transplacentally from mothers, and during subsequent months by active virus infection. Parainfluenza 3 neutralizing antibody at low titres 8–32 conferred about a twofold reduction of the rates of development of febrile illness and isolation of virus following a subsequent infection with the same serotype, in contrast to rates for seronegative infants with titres < 8; high titres 64–1024 were associated with a further twofold reduction of rates for illness and virus isolation. Similar protective effects of maternal antibody were

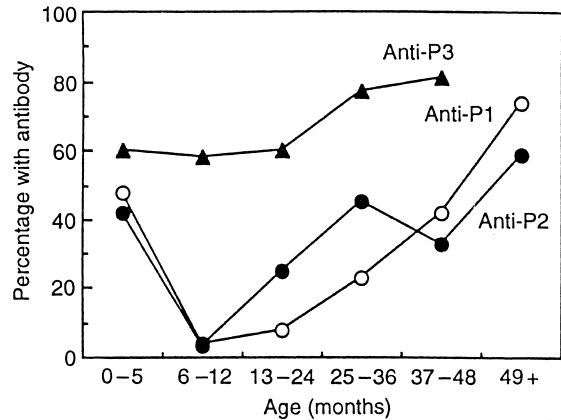

Figure 6.3 Acquisition of parainfluenza neutralizing antibodies by age. (Adapted from Parrott, R.H. *et al.* (1962) *American Journal of Public Health*, 52, 907–917)

demonstrated for infants in Houston, Texas, with cord blood antibody titres > 256 (Glezen *et al.*, 1984).

Family studies at Tecumseh, Michigan, between 1976 and 1981 (Monto *et al.*, 1986) have shown a sixfold higher isolation rate of parainfluenza viruses among children aged < 5 years than in older subjects and 50–80% of virus excretors of all ages experienced upper respiratory infections, but about twice as many infected children aged < 5 years experienced fever than older subjects. Peak occurrence of parainfluenza 1 infections was noted during September and October; parainfluenza 3 infections were more evenly distributed throughout winter.

Surveillance studies at Houston, Texas, between 1975 and 1980 revealed that a higher proportion of parainfluenza-associated respiratory infections among children aged < 5 years were due to parainfluenza 3 virus (66%) than parainfluenza 1 virus (25%) (Glezen *et al.*, 1984) and this age group comprised 69% of all parainfluenza virus-positive cases. Although parainfluenza 3 virus infections remained endemic during all months of 1975 and 1976, they showed peaks of prevalence during March (spring) of each year 1977–1980, in contrast to parainfluenza 1 infections which peaked in January (winter) of each year. Family studies showed that parainfluenza 3 virus induced about 67 infections per 100 child-years in infants aged < 2 years, and this rate decreased to 16 per 100 child-years by age 5 years. However, only 11% of infants aged < 1 year developed lower respiratory disease such as croup or bronchiolitis, but 21% aged 1–2 years developed these complications. Second or subsequent infec-

Table 6.3 Laboratory diagnosis of respiratory tract infections usually associated with parainfluenza viruses

Syndrome	Serotypes usually found	Specimen	Virus identification				Serology	
			Rapid non-cultura		Virus isolation		Test	Performance time
			Electron microscopy	Immuno-fluorescence	Tissue culture	Effect		
Croup	Parainfluenza 1,3	n/p, throat	Enveloped 120–300 nm	Indirect	Monkey kidney ^{a,b} 33°C, 37°C	Haemadsorption	HI NT	2 hours 4–7 days
Tracheo-bronchitis	Respiratory syncytial	n/p, throat	Enveloped 120–300 nm	Indirect	Diploid human ^c	Syncytia	CF NT	24 hours 4–7 days
Bronchiolitis			Helical		Polyloid human		ELISA	8 hours
Pneumonia								

CF = complement fixation; ELISA = enzyme-linked immunosorbent assay; HI = haemagglutination inhibition; n/p = nasopharyngeal secretions obtained by suction; NT = neutralization in tissue culture; throat = throat gargling or swab.

^aAlso detects influenza virus (haemadsorption), enterovirus and rhinovirus (cytopathic effect).

^bIf respiratory syncytial virus is suspected by immunofluorescence, use diploid human cells also.

^cIf parainfluenza or influenza viruses are suspected by immunofluorescence, use monkey kidney cells also.

tions with parainfluenza 3 virus were observed twice as commonly among infants aged 1–2 years without detectable neutralizing antibody (titre < 8) than in those with titres elevated to 128, and this difference persisted through age 2–3 years.

Parainfluenza 3 virus excretion in throats of Houston children with acute respiratory infections persisted longer than other respiratory viruses. Parainfluenza 3 virus was detected in one or more specimens each day among nine of 26 (35%) throat secretions collected up to 6 days before onset of illness and on each day subsequent among 60 of 125 (48%) secretions obtained 0–10 days after onset (Frank *et al.*, 1981). After 10 days, parainfluenza 3 virus was excreted intermittently until 19 days. In four children whose throat secretions yielded parainfluenza 3 virus 4 days before to 5 days after onset of respiratory illness, virus was again detected as late as days 29–32. Excretion of influenza A and respiratory syncytial virus, however, was confined almost exclusively to the initial 7 days after onset of respiratory illness.

Longitudinal studies at Nashville, Tennessee between 1974 and 1993 revealed 286 (5.6%) parainfluenza virus isolates among 5099 otherwise healthy children aged 0–5 years who developed acute respiratory infections. These included 66% with croup, 22% with lower respiratory illness and 18% with upper respiratory illness (Reed *et al.*, 1997). Parainfluenza 3 virus (157 isolates) were achieved during every month of the year, with peak isolation rates in spring from March through May. However, detec-

tion of parainfluenza 1 (77 isolates) and parainfluenza 2 (33 isolates) was confined to April through December, with peak isolation rates in autumn during October. Age-specific infection rates for parainfluenza 3 virus were highest in children aged 0–3 years, while parainfluenza 1 and parainfluenza 2 viruses showed no significant age-specificity. Reinfections with parainfluenza 3 virus were observed in 19 children after intervals of 6 months to 3 years (average 1.36 years); no reinfections were noted after infection with parainfluenza 1 or parainfluenza 2 viruses.

Parainfluenza Virus Infections in Adults

Respiratory tract illnesses affecting adults at McMurdo Station, Antarctica, between 15 October and 15 November 1975, were attributed principally to parainfluenza virus infections (Parkinson *et al.*, 1979). Of 39 personnel with respiratory illnesses, five viral isolates (from four subjects) were parainfluenza 1 and three isolates were parainfluenza 3. The only additional isolates were strains of rhinovirus. Respiratory infections began shortly after the arrival of successive groups of personnel who had been transported directly by air from the USA, commencing during September 1975. Parainfluenza infections were prevalent in USA at that time. Between April and August 1975, when Antarctic personnel received no visitors or supplies from the outside world, no respiratory tract illnesses were recorded. These observations demonstrated: (1)

that parainfluenza viruses were important aetiological agents of respiratory infections among Antarctic personnel; (2) the necessity of continuing to introduce parainfluenza viruses into remote communities in order to maintain their transmission between personnel.

DIAGNOSIS

Principles

Laboratory diagnosis depends upon the selection and application of a combination of virological tests appropriate to the infective agent inducing the syndrome. Although croup is a well-defined, easily recognized clinical entity, and despite the 80% or better likelihood that the causative virus is parainfluenza in most communities, the capability of any test system must be sufficiently broad to include additional agents such as influenza and respiratory syncytial viruses. Conversely, although bronchiolitis in children is regularly caused by respiratory syncytial viruses, a few cases may be induced by parainfluenza virus (Table 6.2).

Virological diagnosis involves three principal categories of test (Table 6.3): (1) rapid non-cultural (morphological) tests employ optimally a combination of electron microscopy plus immunofluorescence (McLean and Wong, 1984), or immunofluorescence alone (Gardner and McQuillin, 1980); these provide a serotype-specific diagnosis of the infecting virus within 3 hours after receipt of nasopharyngeal secretions or throat swabs in the laboratory; (2) virus isolation tests, using tissue culture techniques and subsequent serotyping of isolates, require 3–10 days for completion (McLean, 1982); (3) serological tests on paired sera are completed within 2 hours to 7 days after receipt of convalescent-phase sera, collection of which must be delayed until 1–3 weeks after onset (McLean, 1982). These principles are consistent with recent statements by an Expert Committee of the World Health Organization (1981).

Specimens

Collection

Every attempt should be made to collect naso-

pharyngeal secretions from children aged less than 5 years by the Auger suction technique (McLean and Wong, 1984). Briefly, a fine-bore catheter is passed through a nostril into the nasopharynx. Secretions are aspirated using suction by a 20 ml or 50 ml capacity syringe attached to the external end of the catheter. For older children and adults, patients gargle 5–10 ml of 0.15 mol L⁻¹ saline for 1 minute, and expectorate the fluid into suitable screw-capped or snap-capped containers. Throat swabs provide less satisfactory specimens for virological diagnosis, and they should be collected only when it is not feasible to obtain garglings or nasopharyngeal suctionings.

Preparation for Tests

For rapid non-cultural tests, microdrops of secretions or garglings are placed directly on carbon-coated electron microscope grids (300 mesh) or swabs are smeared directly on grids, which are dried in air and stained for 30 seconds with 2% phosphotungstic acid. Cellular deposits after centrifugation of secretions or garglings are applied to each cup of 12-cup Teflon-coated slides, or throat swabs are smeared directly over cups (Figure 6.4). Slides are dried on a warming plate at 40°C, and fixed for 10 minutes in ice-cold acetone. If the laboratory is remote from the patients, these samples may be stored at ambient temperatures for several days, or shipped unrefrigerated by postal services or common carriers.

For virus isolation tests, secretions or swabs should be suspended immediately in 2 ml tissue culture maintenance medium containing 10% inactivated fetal bovine serum or 0.75% bovalbumin and held at 4°C until inoculated into tissue cultures within the ensuing 24 hours. If longer transit or holding times are likely, the suspensions should be placed in screw-capped or snap-capped vials and held in refrigerated cabinets at -60°C until tested.

Serological tests require the collection of two blood samples. The early (acute phase) sample is collected aseptically by venepuncture as soon as possible after initial examination of the patient, which is usually 1–2 days after onset of the illness. The later (convalescent phase) sample is collected 1–3 weeks subsequently, when fever and other symptoms have resolved completely. Sera should be separated from clots within a few hours after collection of blood samples, and stored at -20°C to

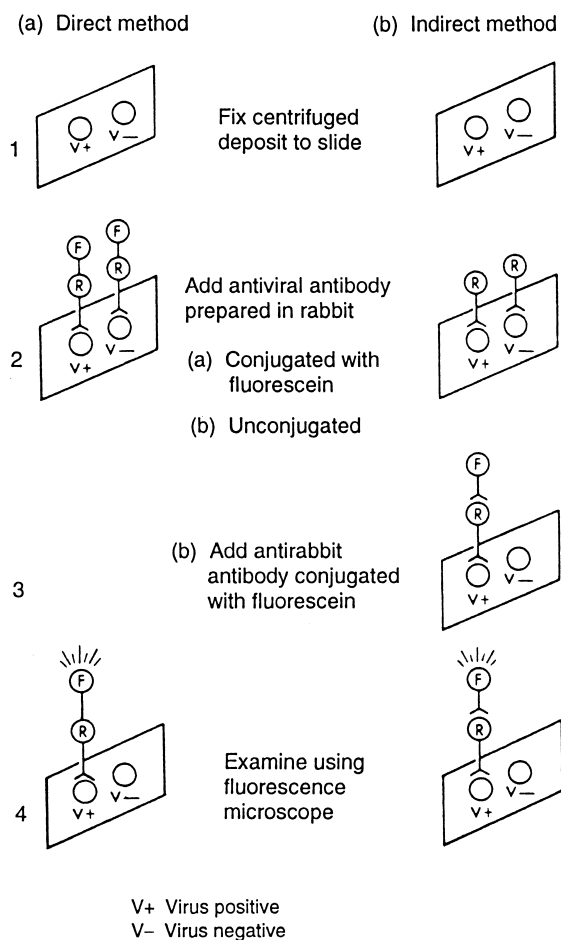

Figure 6.4 Immunofluorescence for detection of virus in throat secretions. (Reproduced with permission from McLean, D.M. *Virology in Health Care*, Figure 3.5, p 38, © 1980 Williams & Wilkins, Baltimore)

await testing. Provided that transit time does not exceed 2–3 days, sera may be shipped between institutions unrefrigerated.

Rapid Non-cultural Tests

Electron Microscopy

Electron microscopic examination of grids is performed immediately after negative staining with phosphotungstic acid. Within 5–15 minutes, virions morphologically typical of the *Paramyxoviridae* are observed in throat or nasopharyngeal secretions

from virus-positive patients. Figure 6.1 shows an enveloped virion of 140 nm total diameter with an outer coat comprised of spikes of haemagglutinin and neuraminidase 12–15 nm high present in the nasopharyngeal secretions of a patient with bronchiolitis.

Immunofluorescence

Antisera to each serotype of parainfluenza and influenza virus prepared in rabbits, and to RS virus prepared in guinea-pigs, are diluted appropriately in phosphate-buffered saline (PBS) pH 7.0 (usually 1 in 10), and microdrops are added to each pair of wells in Teflon-coated acetone-fixed slides containing the patient's specimens. Slides are incubated at 37°C for 30 minutes in a humidified atmosphere and washed three times with PBS; each cup is overlaid with a microdrop of the appropriate fluorescein-labelled antirabbit or antiginea-pig antiserum diluted 1 in 20. Slides are incubated for an additional 30 minutes, washed three times with PBS, counterstained for 1 minute with 0.01% naphthalene black in PBS, then washed three times in PBS and examined by incident light fluorescence microscopy. Immunofluorescent foci in the cytoplasm of cells treated with rabbit anti-parainfluenza 1 serum followed by antirabbit serum, but not in cells which received other antiviral serum, indicate that the patient was infected with parainfluenza 1 virus. This result, which is serotype specific, is obtained within 3 hours of receipt of specimens, thus providing same-day confirmation of preliminary results obtained by electron microscopy.

When an accurate virological diagnosis is achieved by same-day non-cultural techniques it may be possible to discharge the patient one or more days earlier than those without demonstrable viral aetiology if management of altered respiration is not required. Studies at the University of British Columbia show the benefit–cost ratio to be 12:1, even if only a single day of hospitalization is saved.

Virus Isolation

Nasopharyngeal or throat specimens are suspended in 2 ml of tissue culture maintenance medium containing 10% fetal bovine serum, centrifuged at 2000g for 10 minutes to deposit bacteria and de-

squamated cells, and supernatants are inoculated into tissue cultures of primary monkey kidney and continuous diploid human fibroblasts. It is advisable to incubate duplicate tissue cultures at both 33°C and 37°C, because some influenza and parainfluenza viruses replicate optimally at the lower temperature. Haemadsorption is performed after approximately 3, 7 and 10 days of incubation by the addition of 0.1% suspensions of guinea-pig and avian erythrocytes in 0.15 mol L⁻¹ sterile saline to each tissue culture cup from which the supernatant fluid has been removed aseptically by pipetting. When haemadsorption is observed, the haemagglutinin titre of virus in the supernatant fluid is determined by serial twofold dilutions of 0.025 ml volumes in 96-cup plastic microplates using 0.5% suspensions in 0.15 mol L⁻¹ saline of guinea-pig or avian erythrocytes.

Serotyping of the viral isolate is performed by mixing of antisera to each parainfluenza and influenza serotype, diluted to contain 10 antibody units per 0.025 ml, with the fresh viral isolate diluted to contain four haemagglutinating doses. Typing antisera should be treated shortly beforehand with heat and periodate or receptor-destroying enzyme to remove inhibitors. Serum-virus mixtures are held at bench temperature (22°C) for 10 minutes before the addition of 0.5% suspensions of erythrocytes. Inhibition of haemagglutination after mixture with anti-parainfluenza 1 serum, but not with antisera to other serotypes, indicates that the new isolate is parainfluenza 1 virus. This serotyping procedure can be completed within about 2 hours.

Alternatively, the serotype of the fresh isolate may be determined by immunofluorescence. After aspiration of fluid from tissue culture cups showing positive haemadsorption reactions, tissue culture cells are removed by forcible pipetting and deposited in wells of Teflon-coated immuno-fluorescence slides. After drying and acetone fixation, antisera to each paramyxovirus serotype, followed by fluorescein-labelled anti-species antibody, are applied. Examination by incident fluorescence microscopy is performed, as for throat secretions (page 287). This serotyping procedure is completed within 3 hours.

Although virus isolation and serotyping are desirable to confirm the virological identification already obtained within 3 hours by rapid non-cultural techniques, the prolonged incubation time (3–10 days) to detect the presence of virus growth

restricts severely the clinical usefulness of virus isolation in the management of patients. However, when viral concentration in nasopharyngeal secretions is too low for detection by electron microscopy or immunofluorescence, virus isolation techniques are essential to identify the virus causing the patient's infection.

Experience in Arizona between 1983 and 1985 (Ray and Minnich, 1987) has shown that immunofluorescence detected parainfluenza 1 in only 63% of throat specimens from which this serotype was isolated in tissue cultures, and parainfluenza 3 in 31% virus culture-positive throat secretions.

Although libraries of cDNA clones of mRNAs for the nucleocapsid protein, nucleocapsid phosphoprotein, matrix protein, haemagglutinin-neuraminidase glycoprotein, fusion glycoprotein and sundry non-structural proteins of parainfluenza 3 virus (Spriggs and Collins, 1986) have been constructed through recent developments in molecular virology, selection and adaptation of appropriate cDNA base sequences for use as probes for detection of parainfluenza 3 virus in throat secretions from patients must await future technical refinements.

Serology

Paired sera should always be examined simultaneously against currently circulating parainfluenza viruses, most conveniently by HI tests. Acute-phase sera should be collected 1–2 days after the onset of croup or other signs of acute respiratory infection; convalescent-phase sera are collected 1–3 weeks subsequently. After treatment with heat and periodate or receptor-destroying enzyme, serial twofold dilutions of patients' sera are examined for their ability to inhibit haemagglutination by four haemagglutinating doses of each parainfluenza serotype. Antibody conversions from negative to positive, or at least a fourfold increase of antibody titre, indicate current virus infection. Although the performance time of this test can be as short as 2 hours, the clinical usefulness of this test is limited due to the obligatory delay in collection of the convalescent-phase serum. Furthermore, the appearance of antibody in sera of young infants following initial parainfluenza virus infections is somewhat erratic; antibody may be detected only after repeated infections.

Neutralizing antibodies may be detected in patients' sera by absence of haemadsorption in tissue cultures after 3 days incubation following inoculation of mixtures of serial twofold dilutions of patients' sera with 100 tissue culture-infective doses of prototype parainfluenza strains. Appearance and persistence of neutralizing antibodies coincide with that for HI antibodies.

Complement-fixing antibody titres to parainfluenza viruses usually appear in patients' sera somewhat later than HI and neutralizing antibodies. Although this technique is useful in epidemiology (Parrott *et al.*, 1962), its relevance to the diagnosis of acutely ill patients is minimal.

Serological investigation of a community for evidence of parainfluenza virus infection has been undertaken by radioimmunoassay (RIA) (Parkinson *et al.*, 1979) with results comparable to those obtained by the more convenient, rapid and inexpensive HI technique. The enzyme-linked immunosorbent assay (ELISA) technique also provides results comparable to HI tests, but the ELISA test requires a spectrophotometer for reading results; moreover, 4–6 hours are required for its performance, in contrast to 2 hours for HI tests which require no sophisticated instrumentation.

Economic Factors

Fees for the performance of virus diagnostic tests were established most recently on 1 April 1991 by the Medical Services Plan of the Province of British Columbia, Canada, and provide an example of the benefits of laboratory diagnosis of parainfluenza virus infection. They are based on detailed cost-accounting of supplies, equipment, technical and professional components of each test. Virus identification by rapid non-cultural techniques costs \$44.50, virus isolation in tissue culture including serotyping of the isolates costs \$81.00 and serological tests on a pair of sera cost \$42.20. These fees contrast with the current per diem charge of \$620.00 for acute care at Vancouver Hospital: University of British Columbia Site in Vancouver. When an accurate virological diagnosis is achieved by same-day non-cultural techniques, patients may be discharged from hospital one or more days earlier than those without demonstrable viral aetiology, provided that a croupette is no longer required. Thus,

in this example, the benefit–cost ratio for the result of a rapid non-cultural technique in reducing by one day the duration of hospitalization of a patient exceeds 12:1.

MANAGEMENT

Appropriate clinical management of patients depends upon their rapid and accurate clinical assessment, combined with presumptive or serotypic identification of the causative virus using same-day diagnostic tests. Most parainfluenza virus infections of infants and children manifest clinically as acute laryngotracheobronchitis (croup), but some patients may develop tracheobronchitis, bronchiolitis or pneumonia. Young children are usually nursed in plastic tents supplied with cool, moistened oxygen (croupette), where they are held for 1–2 days until their respiration becomes quiet and unlaboured. Severe respiratory obstruction may require endotracheal intubation followed by tracheotomy to establish a satisfactory airway. Accumulation of excessive tracheobronchial secretions in severe bronchiolitis and pneumonia may necessitate their removal by emergency bronchoscopic aspiration. Antibiotics are not normally prescribed in croup, tracheobronchitis or bronchiolitis, but appropriate antibiotics may be required if bacteriological investigations of these conditions or pneumonia reveal concomitant infections with human bacterial pathogens.

PREVENTION

Spread of parainfluenza virus infections within hospitals is well documented. In Newcastle upon Tyne between November 1970 and October 1972, parainfluenza virus infections were identified in 19 children who were contacts on paediatric wards of 134 patients who were admitted to hospital with respiratory infections due to parainfluenza viruses (Gardner *et al.*, 1973). In one episode, clinically manifest and virologically confirmed parainfluenza 1 virus infections developed in three paediatric ward contacts of the index case, and also the attending house physician who subsequently carried the infection to a surgical patient in a different ward. However, in Newcastle, and also in Rochester, New

York (Hall, 1981), respiratory syncytial and influenza viruses continue to cause a higher proportion of virus-induced nosocomial respiratory infections than parainfluenza viruses.

Dissemination of parainfluenza 1 virus by airborne droplets was demonstrated on a croup ward in Toronto (McLean *et al.*, 1967). Parainfluenza 1 virus (3 TCD₅₀) was isolated from 150 litres of air sampled from a croupette which housed a croupy child who excreted 300 TCD₅₀ ml⁻¹ in his nasopharyngeal secretions in January 1967; 10 TCD₅₀ parainfluenza 1 virus was recovered from 150 litres of air surrounding a croupy patient who excreted 10 000 TCD₅₀ parainfluenza 1 per ml nasopharyngeal secretions during February 1967.

In the absence of effective antiviral agents and vaccines against parainfluenza virus infections, limitation of nosocomial spread of these viruses should be attempted along the following lines (McLean *et al.*, 1967; Gardner *et al.*, 1973). Paediatric patients who are admitted to hospital with croup should be nursed in wards, preferably with cubicles or barriers, which are reserved for that syndrome alone. Patients with other acute respiratory infections such as bronchiolitis should also be nursed in separately designated areas. Avoid, if possible, admissions to wards containing paediatric patients with respiratory infections those patients with conditions which predispose to parainfluenza infections such as cystic fibrosis and immunosuppressive states. Promote the dilution of virus below infective limits, in expired air adjacent to patients with respiratory infections, through more frequent exchanges of air by more adequate ventilation, with discharge of room air to the exterior.

Prophylaxis against parainfluenza virus infections in humans through vaccines must await future developments. Bovine parainfluenza 3 virus evoked serotype specific antibody responses and protection against subsequent challenge with human parainfluenza 3 virus in non-human primates (Coelingh *et al.*, 1988). Envelope glycoproteins of parainfluenza 2 virus solubilized selectively with actylglucoside have induced high-titre serotype-specific antibody responses in serum and respiratory secretions of hamsters after intranasal immunization and protected completely against challenge with live parainfluenza 2 virus (Ray *et al.*, 1990). Comparable serotype-specific responses were observed with parainfluenza 3 envelope glycoproteins (Ray *et al.*, 1988).

REFERENCES

- Banatvala, J.E., Anderson, T.B. and Reiss, B.R. (1964) Parainfluenza infections in the community. *BMJ*, **1**, 537–540.
- Chanock, R.M., Parrott, R.H., Vargosko, A.J. *et al.* (1962) Acute respiratory diseases of viral aetiology IV. Respiratory syncytial virus. *American Journal of Public Health*, **52**, 918–925.
- Chapman, R.S., Henderson, F.W., Clyde, W.A. Jr *et al.* (1981) The epidemiology of tracheobronchitis in pediatric practice. *American Journal of Epidemiology*, **114**, 786–797.
- Coelingh, K.L.V., Winter, C.C., Tierney, E.L. *et al.* (1988) Attenuation of bovine parainfluenza virus type 3 in non-human primates and its ability to confer immunity to human parainfluenza virus type 3 challenge. *Journal of Infectious Diseases*, **157**, 655–662.
- Dick, E.C., Mogabgab, W.J. and Holmes, B. (1961) Characteristics of parainfluenza 1 (HA-2) virus. I. Incidence of infections and clinical features in adults. *American Journal of Hygiene*, **73**, 262–272.
- Fairfield Hospital, Melbourne, Australia, *Annual Report*, 1982, 1986.
- Foy, H.M., Cooney, M.K., Maletzky, A.J. *et al.* (1973) Incidence and etiology of pneumonia, croup and bronchiolitis in pre-school children belonging to a prepaid medical care group over a four-year period. *American Journal of Epidemiology*, **97**, 80–92.
- Francki, R.I.B., Fauquet, C.M., Knudson, D.L. *et al.* (1991) Classification and nomenclature of viruses: fifth report of the International Committee on Taxonomy of Viruses. *Archives of Virology*, **Suppl. 2**.
- Frank, A.L., Taber, L.H., Wells, C.R. *et al.* (1981) Patterns of shedding of myxoviruses and paramyxoviruses in children. *Journal of Infectious Diseases*, **144**, 433–441.
- Gardner, P.S. and McQuillin, J. (1980) *Rapid Virus Diagnosis: Application of Immunofluorescence*, 2nd edn. Butterworth, London.
- Gardner, P.S., McQuillin, J., McGuckin, R. *et al.* (1971) Observations on clinical and immunofluorescent diagnosis of parainfluenza virus infections. *BMJ*, **2**, 7–12.
- Gardner, P.S., Court, S.D.M., Brocklebank, J.T. *et al.* (1973) Virus cross-infection in paediatric wards. *BMJ*, **2**, 571–575.
- Glezen, W.P., Frank, A.L., Taber, L.H. *et al.* (1984) Parainfluenza virus type 3: seasonality and risk of infection and reinfection in young children. *Journal of Infectious Diseases*, **150**, 851–857.
- Hall, C.B. (1981) Nosocomial viral respiratory infections: perennial weeds on pediatric wards. In *Nosocomial Infections* (ed. R.E. Dixon), pp 227–233. Yorke Medical Books, New York.
- Heilman, C.A. (1990) Respiratory syncytial and parainfluenza viruses. *Journal of Infectious Diseases*, **161**, 402–406.
- McKinney, R.W., England, B.L. and Froede, S. (1959) Studies with haemadsorption virus type 1. I. Recovery from two cases of influenza-like disease in military personnel and related investigations. *American Journal of Hygiene*, **70**, 280–296.
- McLean, D.M. (1982) *Immunological Investigation of Human Virus Diseases. Vol. 5, Practical Methods in Clinical Immunology* (series ed. R.C. Nairn). Churchill Livingstone, Edinburgh.
- McLean, D.M. (1988) *Virological Infections*. Thomas, Springfield IL.
- McLean, D.M. and Wong, K.K. (1984) *Same-day Diagnosis of*

- Human Virus Infections*. CRC Press, Boca Raton FL.
- McLean, D.M., Bach, R.D., Larke, R.P.B. *et al.* (1963) Myxoviruses associated with acute laryngotracheobronchitis in Toronto, 1962–63. *Canadian Medical Association Journal*, **89**, 1257–1259.
- McLean, D.M., Bannatyne, R.M. and Givan, K.F. (1967) Myxovirus dissemination by air. *Canadian Medical Association Journal*, **96**, 1449–1453.
- Monto, A.S., Koopman, J.S. and Bryan, E.R. (1986) The Tecumseh study of illness. XIV. Occurrence of respiratory viruses, 1976–1981. *American Journal of Epidemiology*, **124**, 359–367.
- Parkinson, A.J., Muchmore, H.G., Scott, L.V. *et al.* (1979) Parainfluenza virus upper respiratory tract illnesses in partially immune adult human subjects. A study at an Antarctic station. *American Journal of Epidemiology*, **110**, 753–763.
- Parrott, R.H., Vargosko, A.J., Kim, H.W. *et al.* (1962) Respiratory diseases of viral etiology. III. Myxoviruses parainfluenza. *American Journal of Public Health*, **15**, 907–917.
- Ray, C.G. and Minnich, L. (1987) Efficiency of immunofluorescence for rapid detection of common respiratory viruses. *Journal of Clinical Microbiology*, **25**, 355–357.
- Ray, R., Glaze, B.J., Moldoveanu, Z. *et al.* (1988) Intranasal immunization of hamsters with envelope glycoproteins of human parainfluenza virus type 3. *Journal of Infectious Diseases*, **157**, 648–654.
- Ray, R., Matsuoka, Y., Burnett, T.L. *et al.* (1990) Human parainfluenza virus induces a type-specific protective immune response. *Journal of Infectious Diseases*, **162**, 746–749.
- Reed, G., Jewett, P.H., Thompson, J. *et al.* (1997) Epidemiology and clinical impact of parainfluenza virus in otherwise healthy infants and young children < 5 years old. *Journal of Infectious Diseases*, **175**, 807–813.
- Rendtorff, R.C., Walker, L.C. and Roberts, A.N. (1963) A parainfluenza-3 outbreak in an orphanage nursery. *American Journal of Hygiene*, **77**, 82–97.
- Spriggs, M.K. and Collins, P.L. (1986) Human parainfluenza virus type 3: messenger RNAs, polypeptide coding assignments, intergenic sequences and genetic map. *Journal of Virology*, **59**, 646–654.
- World Health Organization (1981) Rapid laboratory techniques for the diagnosis of viral infection. Report of a WHO scientific group. *WHO Technical Report Series*, no. 661.

Respiratory Syncytial Virus

Caroline B. Hall

University of Rochester School of Medicine, Rochester, New York, USA

INTRODUCTION

On the barely born
the Gods bestow
the most potential,
the greatest woe.

Respiratory syncytial virus (RSV) infections are a common and concerning conundrum. This ubiquitous agent is the major respiratory pathogen of young children, with life-threatening illness occurring most frequently in the first few months of life. Much about this virus, however, we do not understand—its immunity, its ‘inner soul’ and its control.

The initial name bestowed upon RSV was chimpanzee coryza agent (CCA), since it was first isolated in 1956 from a colony of chimpanzees suffering from the common cold. The human source of the pathogen was subsequently recognized by an identical agent being recovered from the respiratory secretions of an infant with pneumonia (Long strain) and from a child with laryngotracheobronchitis (Chanock *et al.*, 1957).

The virus has now been recognized throughout the world as causing widespread outbreaks of pneumonia and bronchiolitis in infants, and tracheobronchitis and upper respiratory tract infections in older children and adults. In temperate climates the virus produces yearly outbreaks in the winter to early spring. The predictability of its pattern of activity is singular among respiratory viruses.

THE VIRUS

RSV belongs to the family *Paramyxoviridae* and is classified in the genus *Pneumovirus*. In size RSV lies between the larger paramyxoviruses and the smaller influenza viruses. The pneumovirus of mice (PVM) shares morphological characteristics with RSV, and this has led to the suggestion that these two viruses be grouped together as metamyxoviruses. RSV is an enveloped, RNA virus of medium size (120–300 nm). Glycoprotein projections, of 12 nm in length and 10 nm apart, give the envelope a thistle-like appearance.

Only relatively recently has the surrounding shroud of the virus been identified and opened to reveal the proteins of its inner soul (Figure 7.1). Ten viral polypeptides have been identified, ranging in size from 160 000 Da (160K) to 9.5K (Huang *et al.*, 1985). Of these 10 viral proteins, eight are structural, including the seven largest (L, G, F, N, P, M, and SH) and two are non-structural proteins (NS1 and NS2). The glycosylated F (fusion) and G (attachment) proteins and the small non-glycosylated hydrophobic protein, SH (or 1A) are transmembrane surface proteins. The viral capsid proteins associated with the mRNA of the genome are the nucleoprotein (N), the phosphoprotein (P) and the polymerase (L). The two matrix proteins present in RSV are the non-glycosylated M and M2 (membrane-associated proteins).

The roles of these proteins in eliciting an immune response and in protection still require further study. Only four of them—F, G, M2, and N—have

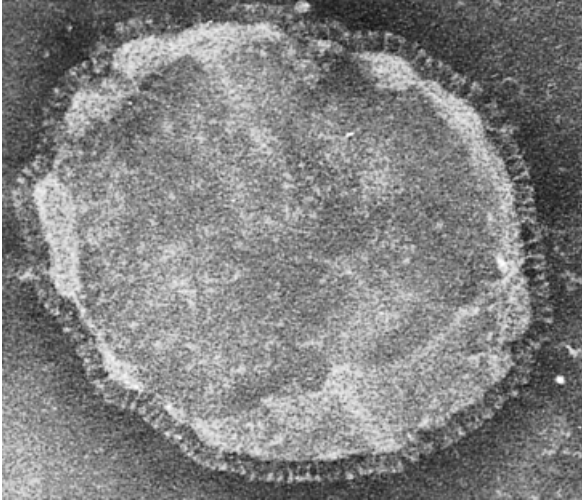

Figure 7.1 Negative contrast electron micrograph of RSV. The fringed envelope is variable in shape. The surface projections are about 15 nm long and the envelope contains a helical nucleocapsid which may occasionally be visible. (Negative contrast 3% potassium phosphotungstate, pH 7.0; $\times 200\,000$; courtesy of Professor C.R. Madeley)

been shown to elicit resistance against RSV challenge, but the protective effect from M2 and N is transient (Connors *et al.*, 1991). Neutralizing antibody is evoked by the two large surface glycoproteins, F and G. The F protein also evokes fusion inhibiting antibodies, probably independent of the neutralization activity (West *et al.*, 1994). These two proteins appear to play a dominant role in immunity. Passive administration of monoclonal antibodies to these two surface glycoproteins has provided protection against subsequent RSV challenge in rodents (Walsh *et al.*, 1987). Antibody to the F protein provides heterologous immunity to both strain groups, whereas antibody to G affords little protection against heterologous strains. Infants are able to produce both F and G antibody after initial RSV infection, but the response to the G protein is more variable. In young infants the heavily glycosylated G protein is a poorer immunogen, and pre-existing maternal antibody results in a greater degree of dampening of the infant's own antibody response.

Antigenic variation among strains of RSV has become the focus of increasing interest and study. The two major strain groups of RSV, designated A and B, have been delineated on the basis of their reactions with monoclonal and polyclonal antisera. The major antigenic differences between these two strain groups have been linked to the G protein (Johnson *et al.*, 1987). The amino acid homology

between G proteins of the two strain groups is $\sim 55\%$, and the antigenic relatedness is only 3–7%. The F protein, on the other hand, is relatively conserved, with prototype A and B strains exhibiting greater than 90% amino acid homology.

In tissue culture RSV produces a characteristic syncytial appearance with eosinophilic cytoplasmic inclusions. RSV has a growth cycle which, after inoculation, consists of a period of adsorption of 2 hours, followed by an eclipse period of 12 hours. The subsequent log phase of replication of the new virus lasts for approximately 10 hours. At the time when maximal quantities of virus are obtained, about half of the virus remains cell-associated on the surface of the cell. Under certain conditions, such as repeated high passage, persistent infection may develop which is associated with a diminished amount of cell-free virus and a loss of the characteristic cytopathic effect.

EPIDEMIOLOGY

RSV appears to enjoy a global distribution and an epidemic personality. Its seasonal pattern (Figure 7.2) is distinctive in that it is the only viral respiratory pathogen to produce predictably a sizeable outbreak of infections each year (Kim *et al.*, 1973). In Great Britain and the temperate parts of the USA the peak period of RSV activity has generally occurred from January to March and is associated with a rise in the number of hospital admissions of young children with lower respiratory tract disease. In the warmer climes of the USA, the peak of the outbreak may be slightly more variable and prolonged, but still occurs during the months of December through April. In more tropical areas RSV outbreaks have occurred during the rainy season (June to December).

The role of strain variation in the epidemiology, severity and clinical impact of an RSV outbreak remains unclear. Strains from both groups appear to circulate concurrently, although the proportion from each group may vary by year and locale (Hall *et al.*, 1990). In most areas in which it has been examined A strains tend to dominate, the outbreaks composed almost entirely of B strains are uncommon. Some evidence has suggested that the magnitude of an outbreak and the severity of the clinical illness are greater with A strain infections, but not

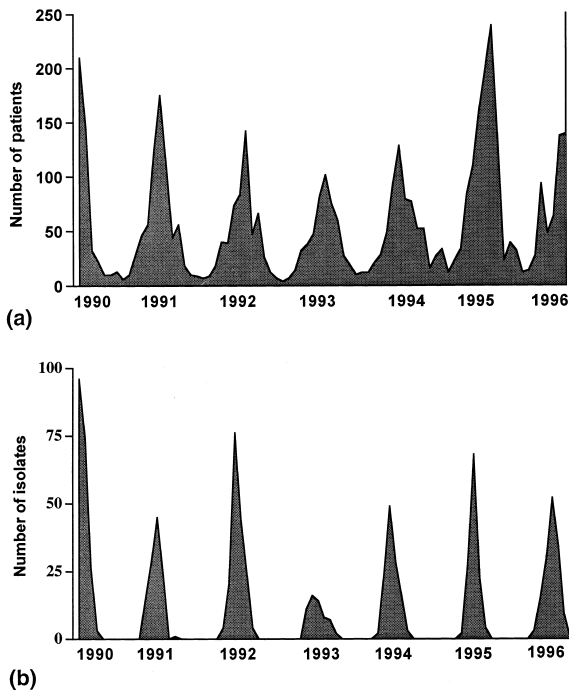

Figure 7.2 Seasonal occurrence of (a) lower respiratory tract disease (bronchiolitis and pneumonia) in children less than 3 years of age in comparison to periods of isolation of (b) RSV. (Data obtained from the community surveillance program for respiratory infections in Rochester and Monroe County, New York)

consistently so (Hall *et al.*, 1990; McConnochie *et al.*, 1990; Toms, 1990).

In most places the size of the annual RSV outbreak will fluctuate, with alternating years being more severe in some areas. Nevertheless, over 11 consecutive years the number of hospital admissions for children with RSV lower respiratory tract disease in Washington DC did not vary more than 2.7-fold, demonstrating the consistent and persistent impact of this virus (Kim *et al.*, 1973). Furthermore, when RSV attains its peak activity in a community, it is usually the solo actor among the company of major respiratory viruses. Other epidemic pathogens, such as influenza and parainfluenza viruses, tend to precede or follow the RSV outbreak, but coincide with it uncommonly.

RSV is highly contagious, and it has been estimated that about half of the infants will acquire RSV infection during their first year of exposure, and approximately 40% of these infections will result in lower respiratory tract disease. Essentially all

children have been infected with RSV during the first 3 years of life. In a prospective longitudinal study of families in Houston, Texas, Glezen *et al.* (1986) showed that 69% of infants in the first year of life were infected with RSV, and one-third of those infections were associated with lower respiratory tract disease. In the second year of life 83% of the infants acquired RSV infection and 16% had lower respiratory tract disease. Even during the third and fourth years of life one-third to one-half of the children were infected with RSV, with lower respiratory tract disease occurring in about one-quarter (Glezen *et al.*, 1986). The attack rate in day care centres is even higher, with 65–98% of the children becoming infected during each of the first 3 years of life and up to one-half of the infections being manifest as lower respiratory tract disease (Henderson *et al.*, 1979). Recurrent infections are, therefore, common and may occur within 1 year or less.

RSV appears to spread with equal facility and alacrity on hospital wards housing young children (Hall *et al.*, 1979). The reasons why RSV is a major nosocomial hazard on paediatric wards are evident from its singular character. Epidemics occur yearly, resulting in a large number of infected infants who are markedly contagious, as they tend to shed the virus abundantly and for prolonged periods. Furthermore, the introduction of RSV on to the paediatric ward assures a susceptible contact population of young infants not previously infected, as well as older children and adults, since immunity is of short duration and repeated infections are frequent. During community outbreaks of RSV infection 20–45% of contact infants have acquired RSV infection nosocomially (Hall *et al.*, 1979; Hall, 1983). Most of these cross-infections result in symptomatic illness, and about half will involve the lower respiratory tract. The morbidity, cost and mortality may be high, particularly in those infants with underlying cardiac, pulmonary and immunodeficiency diseases, who tend to be grouped on such wards (Hall *et al.*, 1979, 1986).

RSV has become a nosocomial pathogen of particular concern on transplant units (Englund *et al.*, 1991; Fouillard *et al.*, 1992). Control of spread of infection once RSV is introduced has been extremely difficult. Children with mild colds visiting family transplant patients are often the source, and the infection in the adult patient frequently is not recognized as being caused by RSV but thought to be one of the opportunistic infections to which such pa-

tients are prone. The outcome, however, may be as devastating or fatal.

The attack rate in hospital personnel on paediatric wards may be similarly high, with up to 50% acquiring RSV infection, and their role in the transmission of nosocomial RSV may be appreciable (Hall, 1983). Infection in staff is manifest most frequently by upper respiratory tract symptoms which may be so mild that absence from work is not required, and this belies the potentially hazardous nature of such an infection on an infants' ward.

The spread of RSV appears to require close contact with infectious secretions, either by large particle aerosols or by fomites (Hall, 1983). Small particle aerosols, which can traverse greater distances, seem to be a less likely mode of transmission for RSV. Hospital staff are apt to spread the virus by touching secretions or contaminated objects while caring for an infected infant. Self-inoculation may then occur by the inadvertent rubbing of their eyes or nose, the major portals of entry for RSV.

PATHOGENESIS

The incubation period for RSV is usually 3–6 days, but can range from 2 to 8 days. Inoculation of the virus appears to occur through the eye or nose, but uncommonly through the mouth (Hall, 1983). The virus subsequently spreads along the epithelium of the respiratory tract, mostly by cell-to-cell transfer of the virus along intracytoplasmic bridges. As the virus spreads to the lower respiratory tract it may produce bronchiolitis and/or pneumonia.

Pathology

Early in bronchiolitis a peribronchiolar inflammation with lymphocytes occurs, and the walls, submucosa and adventitial tissue appear oedematous (Figure 7.3). This progresses to the characteristic necrosis and sloughing of the bronchiolar epithelium, which may also be associated with a proliferative response of the epithelium. Plugging of these small airways results from the sloughed, necrotic material, leading to obstruction of the flow of air, the hallmark of bronchiolitis. The tiny lumina of an infant's airways are particularly prone to obstruction

from such inflammatory exudate and increased secretion of mucus.

If the bronchiolar lumina are incompletely obstructed, air trapping will occur distal to the sites of partial occlusion. Similar to a ball and valve mechanism, air flow is less impeded during the negative pressure of the infant's inspiration. But with the increased pressure of expiration, the airway lumen narrows, causing greater or complete obstruction to the flow of air. The trapped air causes the characteristic hyperinflation of bronchiolitis, which when adsorbed, results in multiple areas of focal atelectasis.

Resolution of these pathological changes may take weeks. Although the bronchiolar epithelium may show signs of regeneration in 3–4 days, ciliated cells rarely can be found within the first 2 weeks. Other changes in the submucosal glands and types of cells in the airway may persist for even longer periods.

The pathological findings of bronchiolitis may progress or coexist with those of pneumonia during RSV infection. In the latter, infiltration of the interstitial tissue with mononuclear cells is seen. The subsequent oedema and necrosis of the parenchyma result in the filling and collapse of the alveolae.

Immunity

No one appears to escape infection with RSV. Almost all infections are acquired during the first 3 years of life, and essentially all adults possess specific antibody. Hence, passive antibody is present in all newborns and in young infants—the age at which the most severe RSV disease occurs. Lower respiratory tract disease from RSV appears to be limited generally to the first 3 years of life (Henderson *et al.*, 1979; Glezen *et al.*, 1986). Repeated infections may occur throughout life, but generally after 3 years of age they are milder, consisting of upper respiratory tract infections or bronchitis (Hall *et al.*, 1991). Repeated infections may also occur during the first 3 years of life, and a second infection in that period of time may be just as severe as the first infection (Henderson *et al.*, 1979). Immunity, therefore, is not durable, but protection against lower respiratory tract disease does occur with time by mechanisms which are poorly understood.

This conundrum of the immunity to RSV and the observation that the most severe disease occurs in the first few months of life, when specific antibody is

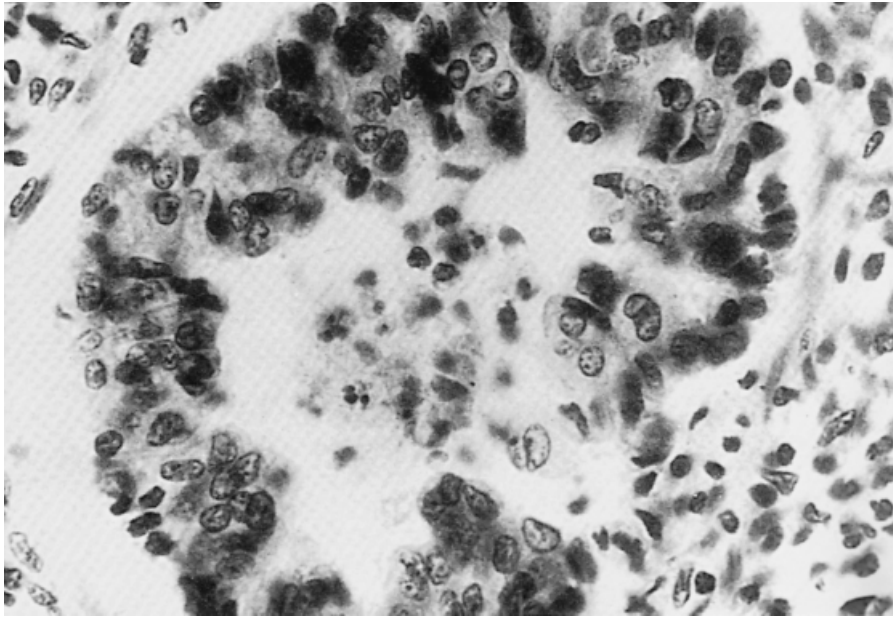

Figure 7.3 Pathological findings of an infant dying with RSV bronchiolitis. The wall of the bronchiole appears inflamed and oedematous, and sloughed, necrotic material fills the lumen in the small airway

invariably and often abundantly present, have engendered speculations that immune mechanisms may actually contribute to the pathogenesis of the disease. An immune complex reaction between maternally acquired IgG antibody and viral antigen has been hypothesized as occurring in the lungs of severely affected infants. Such a mechanism has also been suggested by the experience with the inactivated RSV vaccine developed in the 1960s. This vaccine evoked high levels of circulating antibody, but when the vaccinees were subsequently exposed to the wild virus they developed more severe disease than did those children who had not received the RSV vaccine. This theory, however, does not explain the observation that severe disease may occur in infants who no longer possess detectable antibody. Furthermore, a number of studies have suggested that maternal antibody may actually be protective. Also, complement levels do not decline during acute infection, as would be expected during an immune-complex process. However, antibody may contribute to disease by other mechanisms, such as by suppressing the infant's own immune response to integral proteins, or by augmenting viral replication (Toms, 1995). *In vitro* infection of macrophages has been enhanced by antisera to the F and G proteins (Krilov *et al.*, 1989).

A cell-mediated immune reaction occurring in

the lower respiratory tract disease of infancy has also been postulated. The inactivated RSV vaccine produced not only serum antibody, but also an aggravated systemic cell-mediated immunity response. Stimulation of T cell responses by RSV or by vaccinia virus recombinants carrying RSV genes in experimental animals has produced both the benefit of enhanced viral clearance and the detrimental result of pathologic lung inflammation (Connors *et al.*, 1994).

The third type of immune reaction which has been suggested is one involving IgE antibody. In this theory bronchiolitis results from an allergic response, mediated by specific IgE generated by previous sensitization to the virus. Specific IgE antibody has been found on epithelial cells in the nasal secretions of infants with RSV infection. In some studies infants with wheezing tended to have higher levels of IgE antibody and histamine in their secretions (Welliver and Duffy, 1993). However, in other studies only low concentrations of RSV IgE antibody were found in the acute and convalescent phases of infants with RSV infection, and these levels did not differ from those found in control infants without viral infection (Toms *et al.*, 1996).

The phenomenon observed following the use of the inactivated RSV vaccine has been studied by the use of animal models (Vaux-Peretz *et al.*, 1992; Con-

nors *et al.*, 1994). Rodents challenged with live RSV after immunization with formalin-activated vaccine develop an enhanced pulmonary pathology similar to that observed in the children who received the inactivated vaccine and subsequently acquired natural RSV infection. High levels of antibody to the F and G proteins, measured by enzyme-linked immunosorbent assay, but low levels of neutralizing antibody developed both in the experimental model and in the children who received the inactivated vaccine, suggesting a detrimental effect of formalin on the neutralizing epitopes of the surface glycoproteins (Murphy *et al.*, 1986).

Recent studies have offered an explanation for this abnormal response in the recipients of the inactivated vaccine by delineating the divergent cellular responses elicited by live RSV infection compared to that from inactivated or killed RSV (Graham *et al.*, 1991, 1993; Bright *et al.*, 1995; Toms, 1995). Live RSV, as with other natural live viral infections, characteristically evokes a T_H1 helper cell response, in which T helper cells are associated with IL-2 and γ -interferon production, as well as IgG2a neutralizing antibody and CD8 + cytotoxic T cells (CTLs). Inactivated RSV and other non-replicating antigens on the other hand usually elicit a Th2 cytokine pattern (IL-4, IL-5, IL-6) and IgG₁ antibody without CTL production. The formalin inactivated vaccine, therefore, may have altered the usual immune response evoked by natural RSV infection to an abnormal one, producing primarily a T_H2 -type response and affecting multiple components of the immune system. *In vitro* studies have suggested further that after prolonged (6 days or more) rechallenge with RSV antigen the T_H response in cells primed by live RSV switches from T_H1 to T_H2 , while in cells primed by the F protein, the response remains T_H1 (Bright *et al.*, 1995). In individuals with previous natural RSV infection a T_H1 response and specific CTL production have been demonstrated *in vitro* (Bangham *et al.*, 1986; Isaacs and McMichael, 1987; Anderson *et al.*, 1994).

Others have suggested that it is not necessary to postulate an abnormal immune response to explain the severity of lower respiratory tract disease in the first months of life. Anatomical considerations and the relative immunological immaturity of the young baby may explain much of the severity of RSV infection during the early months of life. The infant's airway is small, and the proportion of the total pulmonary flow resistance from the small pe-

ripheral airways is much larger than in older children.

The normal immune response to RSV infection has recently been better delineated. Primary infection in infants is associated with a specific serum IgM antibody response which is transitory. In about the second week after infection IgG antibody may be detected, but the amounts diminish after 1–2 months. An IgA serum antibody response in young infants may not be detectable. After repeated infection an anamnestic response generally occurs in all three immunoglobulin classes.

The importance of the specificity and type of antibody in protection and recovery from RSV is as yet unclear. Young infants may have a poor neutralizing antibody response and diminished responses to the F and G proteins. These proteins are glycosylated, especially the G protein, and thus are poor immunogens, and maternal antibody may interfere with the antibody response in infants.

Specific secretory antibody has also been identified in the secretions of infected infants. IgA, IgG and IgM antibodies bound to epithelial cells and free in nasal secretions have been identified during the course of infection.

Little is known about systemic and, especially, local cell-mediated immune responses in infants with RSV infection. However, the importance of cellular immunity in protection against RSV disease is supported not only by the animal model studies mentioned above, but also by the observation that children, as well as adults, who have deficient cell-mediated responses tend to have prolonged, severe and sometimes fatal infection with RSV (Hall *et al.*, 1986). Specific lymphocyte transformation is detectable in infants within 1 month of infection, but it has not been correlated clearly with the severity of the infant's illness nor with recovery and protection. Of interest also is the observation that RSV infection in both infants and adults is associated with little or no detectable interferon in the nasopharyngeal secretions.

CLINICAL FEATURES

Infection in Infants and Young Children

RSV is such an important cause of lower respiratory tract disease in the young that at the periods

of peak occurrence of pneumonia and bronchiolitis in young children the presence of RSV in the community may be assumed. RSV has been reported in various studies as causing 5–40% of the pneumonias and bronchitis in young children, as well as 50–90% of the cases of bronchiolitis. Its contribution to cases of croup is relatively smaller, with less than 10% being associated with RSV infection.

The severity of RSV infection appears to be affected not only by age, but also by gender and socioeconomic factors. Despite an equal attack rate, boys require hospitalization more often than girls, and a higher proportion of infants from crowded and industrialized environments tend to be hospitalized. In non-urban, middle to upper class areas, one of 1000 infants infected in the first year of life may require hospitalization, whereas in industrialized, poorer economic environs the rate has been reported to be as high as one in 50 infants.

Primary infections are almost always symptomatic but may be as mild as a common cold or as severe as a life-threatening lower respiratory tract infection. The initial manifestations of RSV infection in infants are usually those of a febrile upper respiratory tract infection. Lower respiratory tract involvement commonly becomes manifest within several days. Although fever is common during the early phase of the illness, the infant may be afebrile by the time the lower respiratory tract disease becomes prominent and hospitalization is undertaken.

The harbinger of the lower respiratory tract disease is often a worsening cough. As the disease progresses, tachypnoea and, often, dyspnoea develop, overtly marked by retractions of the chest wall. In bronchiolitis the respiratory rate may be strikingly elevated, and wheezing and hyperinflation are hallmarks of the disease. However, crackles may also be present. In pneumonia the crackles may be localized or diffuse and may be accompanied intermittently by wheezes. Indeed, bronchiolitis and pneumonia often appear to represent a continuum and may be difficult to differentiate clinically. The variability in auscultatory findings and in the respiratory rate within short periods of time is frequent enough in infants with lower respiratory tract infection due to RSV to be considered characteristic. The course of the illness similarly may be variable, lasting from one to several weeks, but most infants will show clinical improvement within 3–4 days of the onset of the lower respiratory tract disease.

Evaluation of the severity of the lower respiratory tract disease in these young infants is often problematic. Fever and the extent of the wheezing or crackles generally do not correlate with the severity of the illness, and the degree of hypoxaemia may not be clinically evident. Cyanosis is present in only a minority of infants, despite the observation that most infants hospitalized with RSV lower respiratory tract infection are hypoxaemic. Hypoxaemia of a moderate to severe degree may be present in an infant who does not appear cyanotic. An increasing respiratory rate has been noted to be one of the better clinical indicators of hypoxaemia.

The hypoxaemia results from the characteristically diffuse involvement of the lung parenchyma, which may not be evident on chest radiography. This produces an abnormally low ratio of ventilation to perfusion. Alveolar hypoventilation and progressive hypercarbia may develop, but are rare in infants given good oxygenation and supportive care.

The radiological picture in infants with lower respiratory tract disease due to RSV may vary from a virtually normal appearance to one which mimics bacterial pneumonia. However, the severity of the infant's illness is not generally mirrored by the radiological changes. Infants with the typical findings of bronchiolitis, hyperinflation and minimal peribronchial increased markings may be severely ill and hypoxaemic. The most characteristic findings on the chest radiograph with RSV lower respiratory tract disease are hyperinflation, infiltrates—which are often perihilar involving more than one lobe—and atelectasis, especially of the right middle or right upper lobes. In the Newcastle upon Tyne studies of infants hospitalized with lower respiratory tract disease due to RSV, hyperinflation was present in over half the children and increased peribronchial markings in 39% (Simpson *et al.*, 1974). Hyperlucency, which occurred as the sole abnormality in 15% of the cases, was particularly associated with RSV infection. Consolidation, which sometimes appeared similar to that found with bacterial infection, was present in approximately one-fourth of the cases and was usually subsegmental in distribution. The radiological abnormalities, as well as the hypoxaemia, tend to persist beyond the time of clinical improvement.

RSV infection in newborns had been thought to occur rarely, but is now recognized as being relatively common. The manifestations of the disease in

the newly-born, however, may be atypical and misdiagnosed clinically (Hall *et al.*, 1979). Neonates, especially in the first 2–3 weeks of life, infrequently have the typical clinical findings of lower respiratory tract disease. More commonly RSV is manifest by such non-specific signs as lethargy and poor feeding. Upper respiratory tract signs may be present in only about half. Premature infants appear to be more susceptible to infection, and the mortality may be high in neonatal intensive care units.

Primary infections may also be milder, especially in older infants, manifest only as tracheobronchitis or upper respiratory tract disease. Such upper respiratory tract infections, however, do tend to be more prolonged and severe than the usual cold. Otitis media is a frequent accompaniment of RSV infection in the first few years of life, particularly in the first year. RSV has been recovered from middle ear aspirates of such infants, both as the sole pathogen and in conjunction with bacterial agents.

Complications

Apnoea is a frequent complication of RSV infection in young infants, occurring in approximately 20% of hospitalized cases. Apnoea may be the initial sign of RSV infection, preceding overt respiratory signs. The apnoea is most likely to occur in premature infants with a gestation of 32 weeks or less and in those of young postnatal age, less than 44 weeks postconceptional age (Church *et al.*, 1984). A history of apnoea of prematurity has also been identified as a significant risk factor for the development of apnoea with RSV infection. The apnoea associated with RSV infection is non-obstructive and tends to develop at the onset or within the first few days of the illness. Although the prognosis for such infants has not been defined accurately, it does not appear to place the infant at increased risk of subsequent apnoea (Church *et al.*, 1984).

Despite the often prolonged and severe course of lower respiratory tract disease in young children, secondary bacterial infection is an unusual complication. In developing countries, however, concurrent bacterial infection is common and may be a major factor leading to the high mortality rate in such infants. Furthermore, antibiotic therapy has been shown not to improve the rate of recovery of infants with RSV lower respiratory tract disease.

Certain groups of children appear to be at risk of developing complicated, severe or even fatal RSV infection. Infants hospitalized in the first few months of life with congenital heart disease appear to be at particular peril. Although all the factors or conditions associated with a poor prognosis for those infants with cardiac lesions and RSV infection have not been defined, pulmonary hypertension accompanying the congenital heart disease appears to increase the risk appreciably. Recent surgical and technical advances and early correction currently have reduced appreciably the mortality and morbidity in infants with congenital heart disease, although their risk for fatal RSV disease still appears to be more than three or fourfold greater than that estimated for other infants hospitalized with RSV infection (Navas *et al.*, 1992).

Infants with underlying pulmonary disease, especially bronchopulmonary dysplasia, also appear to be at risk of developing prolonged and complicated infection with RSV, even in their second year of life. Another group of children who are prone to extensive and severe RSV infection are those who are immunosuppressed or have a congenital immunodeficiency disease (Hall *et al.*, 1986; Pohl *et al.*, 1992). These children may develop lower respiratory tract disease at any age and tend to have extended shedding of the virus. RSV infection has also been shown to be associated with exacerbations and complications in children with nephrotic syndrome and cystic fibrosis.

Perhaps the most frequent complication from RSV lower respiratory tract disease in early infancy is prolonged alterations in pulmonary function which may predispose to chronic lung disease in later life. A number of studies have associated bronchiolitis in infancy with surprisingly high rates of recurrent wheezing and lower respiratory tract disease. In some children these clinical manifestations improve with age, and in others pulmonary function abnormalities may persist but be clinically silent. Whether such children who go on to have recurrent wheezing and lower respiratory tract disease are those who are genetically predisposed to hyperreactive lungs, have smaller airways or an atopic diathesis, or whether the bronchiolitis augmented or engendered a lasting hyperreactivity of the airways, is unclear (Landau, 1994). Studies in which the initial infection was identified as being caused by RSV and in which the children were prospectively followed have indicated that atopy

does not appear to be the major factor in predicting which children will develop such long-term pulmonary abnormalities. In a subgroup of children, however, atopy does appear to be a major factor in increasing their risk of more severe RSV disease and subsequent complications such as recurrent wheezing (Welliver and Duffy, 1993).

Infection in Older Children and Adults

Repeated RSV infections occur throughout life, and the interval between infections may be only weeks or months (Hall *et al.*, 1991). In older children and adults these repeated infections are usually manifest as upper respiratory tract infections or sometimes as tracheobronchitis. In a minority of adults, usually less than 15%, the infection may be asymptomatic. Even in young healthy adults, RSV infection may be associated with pulmonary function abnormalities, mostly a hyperreactivity of the airway to cholinergic stimulus, which may last for a couple of months.

RSV infection in the elderly may be more severe and have some similarities to infection at the other end of the age spectrum (Falsey *et al.*, 1995). In the elderly, RSV has been associated with exacerbations of chronic bronchitis and can produce a flu-like syndrome indistinguishable from that of influenza. Outbreaks of RSV infection may occur more frequently than is generally recognized in institutions for the elderly and can result in a high incidence of pneumonia. The relative role of the virus and of the usual bacterial pathogens in pneumonia in this elderly population is unclear.

On acute medical wards RSV infections, both nosocomially and community acquired, in adult patients and staff are being increasingly recognized (Takimoto *et al.*, 1991; Falsey *et al.*, 1995). Those with the most severe clinical manifestations generally are those with chronic or immunosuppressive underlying conditions.

DIAGNOSIS

RSV infection may be diagnosed by identification of the viral antigen by a rapid diagnostic technique or by isolation of the virus in tissue culture. Rapid diagnosis is important in management for the initi-

ation of proper infection control procedures and for antiviral chemotherapy.

Both direct and indirect immunofluorescent reagents, utilizing either polyclonal or monoclonal antibodies, are available, possessing a high degree of specificity and sensitivity. The fluorescent pattern observed will depend on the antibody used. Monoclonal antibody to the nucleocapsid protein or the phosphoprotein will produce specific large and small cytoplasmic inclusions in RSV-positive cells, while monoclonal antibody to the fusion (F) protein shows diffuse cytoplasmic staining. Polyclonal antiserum produces both the specific inclusions and diffuse staining in the cytoplasm (Figure 7.4).

A variety of rapid assays for detecting RSV antigen have become available recently. Most are based on an enzyme immunosorbent assay (EIA). A number of commercial kits, which rely on a qualitative colour change, are simple and suitable for outpatient clinics and offices. However, the sensitivity and specificity of these kits may be variable and results are likely to be considerably less accurate in a busy clinic than those reported in published studies from evaluating laboratories.

The sensitivity of the EIA assays against isolation of the virus in cell culture has ranged from about 50 to 95% and the specificity from about 70 to 100%. A major factor in the reported sensitivity of these assays is the quality and sensitivity of the viral isolation in tissue culture to which it is being compared. The success of viral isolation has varied greatly in different laboratories, partly because of the lability of RSV, the quality and transport of the specimen, and, particularly, the sensitivity of various cell lines.

Nasal washes or tracheal secretions are generally the best specimens for isolation. The specimen should be inoculated on to tissue culture promptly and without subjecting it to major temperature changes. RSV is a relatively labile virus and withstands freezing and thawing poorly. At 37°C approximately 10% of infectivity of the virus in tissue culture medium remains after 24 hours. However, at 4°C in certain media, such as veal infusion broth, little loss in virus titre may occur for 2–3 days. Control of the pH of the media is important in preventing loss of infectivity, the optimum pH being 7.5.

Human heteroploid cells, such as HEp-2 and HeLa cells, generally provide the best tissue culture for the isolation of RSV. The sensitivity of such cell

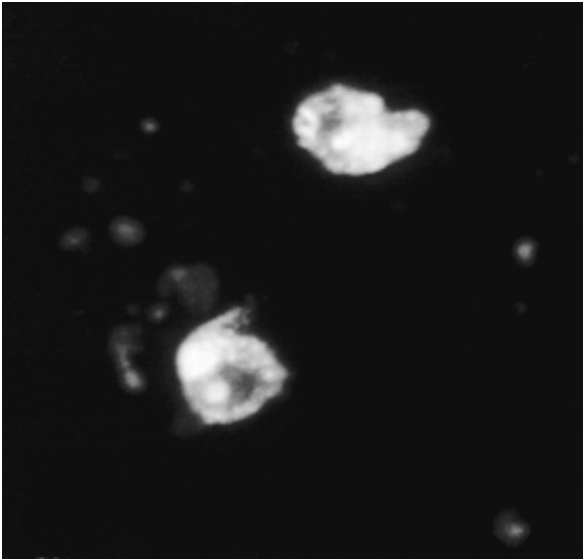

Figure 7.4 Positive indirect immunofluorescent antibody test on nasal secretions from an infant with lower respiratory tract disease due to RSV

lines, however, may be variable and require constant monitoring. In such continuous cell lines the characteristic cytopathic effect (CPE) of RSV is the formation of syncytia. These contain eosinophilic cytoplasmic inclusions. These syncytia are usually evident 2–7 days after inoculation, most commonly in 3–5 days.

The growth and CPE in tissue culture may vary with different strains of RSV. Generally B strain viruses are more difficult to grow and may not have the characteristic syncytial appearance. One of the most important factors in recognition of the characteristic CPE of RSV is that the cell lines used should be young and lightly seeded at the time of specimen inoculation (Figure 7.5). Heavy growth of the tissue culture may prevent the development of the characteristic RSV CPE.

The diagnostic methods chosen for an individual laboratory should depend on its facilities, the technical expertise and the volume of patient specimens. EIA techniques may offer the advantages of objective interpretation, speed and suitability for large numbers of specimens. Disadvantages may include poorer sensitivity with swab specimens in comparison to nasopharyngeal aspirates and a 'grey zone' of equivocal results, which in quantitative assays requires confirmation by a time-consuming blocking ELISA procedure. Immunofluorescence techniques are generally not as fast or easy as EIA kits, but may

have greater specificity and are more suitable for testing smaller numbers of daily specimens. The disadvantages are the requirements for a technician trained in reading the fluorescent patterns and for a specimen that contains adequate nasopharyngeal cells. Ideally a diagnostic laboratory should use a combination of techniques, preferably a rapid diagnostic assay in combination with viral isolation.

Serological diagnosis by detecting antibody rises in acute and convalescent sera is unlikely to be of help in the management of the patient because of the time required. Furthermore, the serological response in young infants may be poor and not detectable by some antibody assays. Seroconversion usually does not occur for at least 2 weeks and may require 4–6 weeks. Several serological tests are available, mostly in research laboratories. Neutralization and EIA most frequently are used and offer the possibility of detecting individual antibody class and specificity.

MANAGEMENT

Most infants do well with their RSV infection with no more than the usual care given for fever and to maintain adequate hydration. In the more severely affected infants with lower respiratory tract disease the quality of the supportive care is most important. Since most hospitalized infants are hypoxaemic, documentation of the blood gases in the more severely ill infant is essential for good management. Most infants respond well to relatively low concentrations of oxygen, since the major parenchymal abnormality is an unequal ratio of ventilation to perfusion. Hypercarbia may develop in the severely ill infant, requiring frequent monitoring of the blood gases and, if progressive, may lead to airway intervention. Hypercarbia and recurrent apnoea are the most frequent reasons for assisted ventilation. Hypoxaemia, unresponsive to oxygen therapy, is less common.

The antiviral agent, ribavirin (1- β -D-ribofuranosyl-1,2,4-triazole-3-carboxamide), has been approved for specific treatment of RSV infection. Ribavirin is a synthetic nucleoside which appears to interfere with the expression of mRNA. It is singular in that its antiviral activity appears to be broad spectrum, affecting a variety of both RNA and DNA viruses *in vivo* and *in vitro*. Ribavirin is ad-

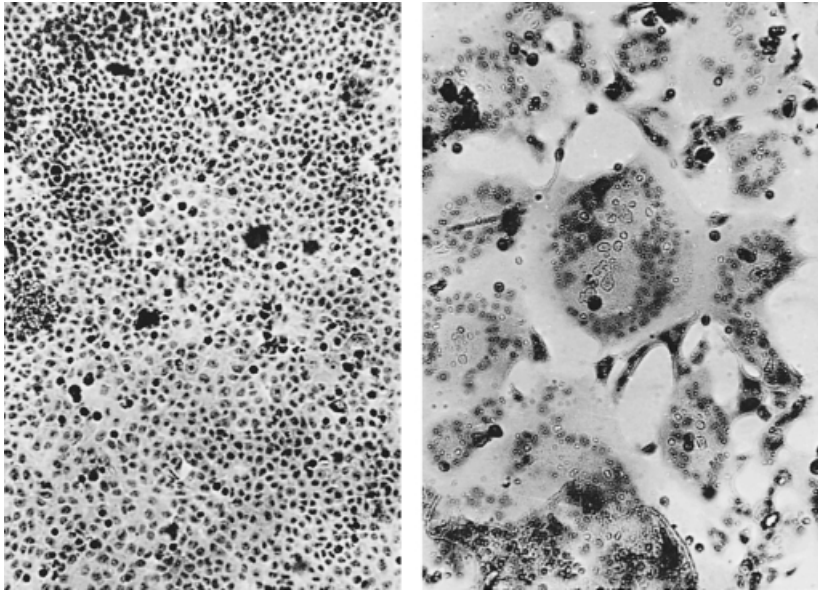

Figure 7.5 Stained preparations of uninfected HeLa cells (left) and cells infected with RSV (right). Syncytial formation is well illustrated by the infected monolayer

ministered by small-particle aerosol into an oxygen tent, oxygen hood or via a ventilator, usually for 12 or more hours per day until clinical improvement, which is usually in 2–5 days (Hall *et al.*, 1983). For which infants ribavirin should be used is controversial. Controlled double-blind studies have shown ribavirin to have a beneficial effect on the clinical course of the RSV bronchiolitis and pneumonia in infants who were mostly mildly to moderately ill, as measured by the rate of improvement in illness severity and on the measured levels of the infants' arterial oxygen saturation, as well as the duration of mechanical ventilation and supplemental oxygenation (Smith *et al.*, 1991); however, the degree of benefit, especially relative to the cost, has been questioned (American Academy of Pediatrics, 1997). Ribavirin should be considered on an individual basis, especially for those infants who have underlying conditions which put them most at risk for severe RSV disease.

No toxicity has been associated with ribavirin therapy and development of resistance to ribavirin by RSV strains or any other virus has not been observed, even with prolonged treatment.

Aerosolized bronchodilators have also been employed intermittently for some patients with bronchiolitis. Their use is controversial, as most studies have failed to show benefit in infants under 18 months of age. In those studies evaluating pulmon-

ary function the results have been conflicting, with some demonstrating no change in pulmonary resistance and some even showing a paradoxical worsening. Some experts would advise that bronchodilator therapy, usually aerosolized, be considered for the more severely affected infants, particularly those above 6 months of age, and that it be carefully monitored initially. Systemic therapy with corticosteroids has not been shown to be of benefit in bronchiolitis or in RSV pneumonia (Springer *et al.*, 1990).

Prevention

For more than a decade research has been directed towards the development of a safe and effective vaccine for RSV. A vaccine for this virus, however, poses particular problems. It would have to be administered at a very young age, within the first few weeks of life, and should be able to produce an immunity more durable than that often seen after natural infection.

The first vaccine developed—the alum-precipitated, formalin-inactivated vaccine tested in the 1960s—produced high levels of serum antibody but then resulted in augmented disease following infection with the wild virus (Toms, 1995). Subsequently,

candidates for an attenuated live vaccine have been sought. Vaccine developed from both cold-adapted strains and from temperature-sensitive (ts) mutants appeared promising in initial trials, but were later shown to be too reactive, genetically unstable or overly attenuated. Renewed interest in the use of an attenuated live viral vaccine has been engendered recently by the promising advances in the development of genetically stable mutant viruses (Chanock *et al.*, 1992; Toms, 1995; Crowe *et al.*, 1996).

New techniques are revealing the molecular soul of RSV. It can be genetically engineered, thus bringing new hopes for immunoprophylaxis against RSV infection. Research has focused on the two major surface glycoproteins, the F and G proteins, as possible immunizing agents (Oien *et al.*, 1993; Paradiso *et al.*, 1994; Toms, 1995). These proteins have appeared promising in experimental animals as subunit vaccines and as carried by vaccinia and adenovirus recombinants. However, the recombinant vaccines have appeared to be less immunogenic and protective in chimpanzees than in rodents. Delineation of specific B and T cell epitopes on these surface glycoproteins which elicit protective immunity is also in progress (Toms, 1990; Hsu *et al.*, 1994).

Other means of protection for limited periods, such as during the first, most vulnerable months of life, may be feasible. Immunization of the mother prior to the infant's birth or chemoprophylaxis of high-risk infants may be possible. Epidemiological studies and those in animal models suggest that breast-feeding may be associated with some protection against more severe RSV infection, but conclusive data are lacking. Administration of intravenous immunoglobulin with high titres of neutralizing antibody to RSV has been shown to be beneficial as a means of prophylaxis for infants with underlying conditions which place them at high risk for severe or complicated RSV infection (Chanock *et al.*, 1992; Groothuis *et al.*, 1993). The administration of RSV intravenous immunoglobulin and monoclonal antibody to RSV are also being studied for therapeutic use.

Prevention of the nosocomial spread of RSV infection is of major importance, as an appreciable proportion of infants hospitalized with high-risk conditions, such as congenital heart disease, bronchopulmonary dysplasia and immunocompromised states, may develop particularly severe or even fatal nosocomial RSV infection (Hall, 1983).

Of the infection control procedures employed to limit the nosocomial spread of RSV, hand-washing is the most important. When compliance with consistent and careful hand-washing is less than optimal, the use of gloves may be of benefit. The routine use of gowns and masks has not been shown to be of additional benefit. The use of gowns, however, may be advisable during periods of close contact in which an infant's secretions are apt to contaminate the clothing. Since RSV primarily infects via the eyes and nose, masks are of limited value, but eye-nose goggles have been shown to be beneficial.

Other procedures of potential benefit include isolation or cohorting of infected infants and assigning nursing personnel to care for either infected infants or uninfected infants, but not both simultaneously. During epidemic periods the number of patient contacts and visitors should be limited. Recognition and cleaning of objects and surfaces contaminated with infant secretions are also advisable. Elective admissions of infants with high-risk conditions should be avoided during the epidemic periods of RSV. For those infants who must be admitted, particular care must be employed to prevent such cross-infections.

REFERENCES

- American Academy of Pediatrics (1997) *Red Book: Report of the Committee on Infectious Diseases*, 24th edn. AAP, Elk Grove Village IL.
- Anderson, L.J., Tsou, C., Potter, C. *et al.* (1994) Cytokine response to respiratory syncytial virus stimulation of human peripheral blood mononuclear cells. *Journal of Infectious Diseases*, **170**, 1201–1208.
- Bangham, C.R., Openshaw, P.J., Ball, L.A. *et al.* (1986) Human and murine cytotoxic T cells specific to respiratory syncytial virus recognize the viral nucleoprotein (N), but not the major glycoprotein (G), expressed by vaccinia virus recombinants. *Journal of Immunology*, **137**, 3973–3977.
- Bright, H., Turnbull, T., Toms, G.L. *et al.* (1995) Comparison of the T helper cell response induced by respiratory syncytial virus and its fusion protein in BALB/c mice. *Vaccine*, **13**, 915–922.
- Chanock, R.M., Roizman, B. and Myers, R. (1957) Recovery from infants with respiratory illness of a virus related to chimpanzee coryza agent (CCA): I. Isolation, properties and characterization. *American Journal of Hygiene*, **66**, 281–290.
- Chanock, R.M., Parrott, R.H., Connors, M. *et al.* (1992) Serious respiratory tract disease caused by respiratory syncytial virus: prospects for improved therapy and effective immunization. *Pediatrics*, **90**, 137–143.
- Church, N.R., Anas, N.G., Hall, C.B. *et al.* (1984) Respiratory syncytial virus-related apnea in infants: demographics and

- outcome. *American Journal of Diseases of Children*, **138**, 247–250.
- Connors, M., Collins, P.L., Firestone, C.Y. *et al.* (1991) Respiratory syncytial virus (RSV) F, G, M2 (22K), and N proteins each induce resistance to RSV challenge, but resistance induced by M2 and N proteins is relatively short-lived. *Journal of Virology*, **65**, 1634–1637.
- Connors, M., Giese, N.A., Kulkarni, A.B. *et al.* (1994) Enhanced pulmonary histopathology induced by respiratory syncytial virus (RSV) challenge of formalin-inactivated RSV-immunized BALB/c mice is abrogated by depletion of interleukin-4 (IL-4) and IL-10. *Journal of Virology*, **68**, 5321–5325.
- Crowe, J.E. Jr, Bui, P.T., Firestone, C.Y. *et al.* (1996) Live subgroup B respiratory syncytial virus vaccines that are attenuated, genetically stable, and immunogenic in rodents and nonhuman primates. *Journal of Infectious Diseases*, **173**, 829–839.
- Englund, J.A., Anderson, L.J. and Rhame, F.S. (1991) Nosocomial transmission of respiratory syncytial virus in immunocompromised adults. *Journal of Clinical Microbiology*, **29**, 115–119.
- Falsey, A.R., Cunningham, C.K., Barker, W.H. *et al.* (1995) Respiratory syncytial virus and influenza A infections in the hospitalized elderly. *Journal of Infectious Diseases*, **172**, 389–394.
- Fouillard, L., Mouthon, L., Laporte, J.P. *et al.* (1992) Severe respiratory syncytial virus pneumonia after autologous bone marrow transplantation: a report of three cases and review. *Bone Marrow Transplant*, **9**, 97–100.
- Glezen, W.P., Taber, L.H., Frank, A.L. *et al.* (1986) Risk of primary infection and reinfection with respiratory syncytial virus. *American Journal of Diseases of Children*, **140**, 543–546.
- Graham, B.S., Bunton, L.A., Rowlands, J. *et al.* (1991) Respiratory syncytial virus infection in anti- μ -treated mice. *Journal of Virology*, **65**, 4936–4942.
- Graham, B.S., Henderson, G.S., Tang, Y.W. *et al.* (1993) Priming immunization determining T helper cytokine in RNA expression patterns in lungs of mice challenged with respiratory syncytial virus. *Journal of Immunology*, **151**, 2032–2040.
- Groothuis, J.R., Simoes, E.A., Levin, M.J. and the RSVIG Study Group (1993) Prophylactic administration of respiratory syncytial virus immune globulin to high-risk infants and young children. *New England Journal of Medicine*, **329**, 1572–1574.
- Hall, C.B. (1983) The nosocomial spread of respiratory syncytial virus infections. *Annual Review of Medicine*, **34**, 311–319.
- Hall, C.B., Kopelman, A.E., Douglas, R.G. Jr *et al.* (1979) Neonatal respiratory syncytial virus infection. *New England Journal of Medicine*, **300**, 393–396.
- Hall, C.B., McBride, J.T., Walsh, E.E. *et al.* (1983) Aerosolized ribavirin treatment of infants with respiratory syncytial viral infection. *New England Journal of Medicine*, **308**, 1443–1447.
- Hall, C.B., Powell, K.P., Macdonald, N.E. *et al.* (1986) Respiratory syncytial viral infection in children with compromised immune function. *New England Journal of Medicine*, **815**, 77–80.
- Hall, C.B., Walsh, E.E., Schnabel, K.C. *et al.* (1990) Occurrence of groups A and B of respiratory syncytial virus over 15 years: associated epidemiologic and clinical characteristics in hospitalized and ambulatory children. *Journal of Infectious Diseases*, **162**, 1283–1290.
- Hall, C.B., Walsh, E.E., Long, C.E. *et al.* (1991) Immunity to and frequency of reinfection with respiratory syncytial virus. *Journal of Infectious Diseases*, **163**, 693–698.
- Henderson, F.W., Collier, A.M., Clyde, W.A. Jr *et al.* (1979) Respiratory syncytial virus infections, reinfections and immunity: a prospective longitudinal study in young children. *New England Journal of Medicine*, **300**, 530–534.
- Hsu, K.H.L., Lubeck, M.D., Bhat, B.M. *et al.* (1994) Efficacy of adenovirus-vectored respiratory syncytial virus vaccines in a new ferret model. *Vaccine*, **12**, 607–612.
- Huang, Y.T., Collins, P.L. and Wertz, G.W. (1985) Characterization of the 10 proteins of human respiratory syncytial virus: identification of a fourth envelope-associated protein. *Virus Research*, **2**, 157–173.
- Isaacs, D. and McMichael, A.J. (1987) Cell-mediated cytotoxic response to respiratory syncytial virus in infants with bronchiolitis. *Lancet*, **ii**, 769–771.
- Johnson, P.R., Prince, G.A., Alling, D.W. *et al.* (1987) Antigenic relatedness between glycoprotein of human respiratory syncytial virus subgroups A and B: evaluation of the contributions of F and G glycoproteins to immunity. *Journal of Virology*, **10**, 3163–3166.
- Kim, H.W., Arrobio, J.O., Brandt, C.M. *et al.* (1973) Epidemiology of respiratory syncytial virus infection in Washington, D.C. I. Importance of this virus in different respiratory disease syndromes and temporal distribution of infection. *American Journal of Epidemiology*, **98**, 216–225.
- Krilov, L.R., Anderson, L.J., Marcoux, L. *et al.* (1989) Antibody-mediated enhancement of respiratory syncytial virus infection in two monocyte/macrophage cell lines. *Journal of Infectious Diseases*, **160**, 777–782.
- Landau, L.I. (1994) Bronchiolitis and asthma: are they related? (Editorial.) *Thorax*, **49**, 293–296.
- McConnochie, K.M., Hall, C.B., Walsh, E.E. *et al.* (1990) Variation in severity of respiratory syncytial virus infections with subtype. *Journal of Pediatrics*, **117**, 52–62.
- Murphy, B.R., Prince, G.A., Walsh, E.E. *et al.* (1986) Dissociation between serum neutralizing and glycoprotein antibody responses of infants and children who received inactivated respiratory syncytial virus vaccine. *Journal of Clinical Microbiology*, **24**, 197–202.
- Navas, L., Wang, E., de Carvalho, V. *et al.* (1992) Improved outcome of RSV infection in a high-risk hospitalized population of Canadian children. *Journal of Pediatrics*, **121**, 348–354.
- Oien, N.L., Brideau, R.J., Thomsen, D.R. *et al.* (1993) Vaccination with a heterologous respiratory syncytial virus chimeric FG glycoprotein demonstrates significant subgroup cross-reactivity. *Vaccine*, **11**, 1040–1048.
- Paradiso, P.R., Hildreth, S.W., Hogerman, D.A. *et al.* (1994) Safety and immunogenicity of a subunit respiratory syncytial virus vaccine in children 24 to 48 months old. *Pediatric Infectious Diseases Journal*, **13**, 792–798.
- Pohl, C., Green, M., Wald, E.R. *et al.* (1992) Respiratory syncytial virus infections in pediatric liver transplant recipients. *Journal of Infectious Diseases*, **92**, 165, 166–169.
- Simpson, W., Hacking, P.M., Court, S.D.M. *et al.* (1974) The radiological findings in respiratory syncytial virus infection in children. II. The correlation of radiological categories with clinical and virological findings. *Pediatric Radiology*, **2**, 155–160.
- Smith, D.W., Frankel, L.R., Mathers, L.D. *et al.* (1991) A controlled trial of aerosolized ribavirin in infants receiving mechanical ventilation for severe respiratory syncytial virus infection.

- New England Journal of Medicine*, **325**, 24–29.
- Springer, C., Bar-Yishay, E., Uwayyed, K. *et al.* (1990) Corticosteroids do not affect the clinical or physiological status of infants with bronchiolitis. *Pediatric Pulmonology*, **9**, 181–185.
- Takimoto, C.H., Cram, D.L. and Root, R.K. (1991) Respiratory syncytial virus infections on an adult medical ward. *Archives of Internal Medicine*, **151**, 706–708.
- Toms, G.L. (1990) Respiratory syncytial virus: virology, diagnosis, and vaccination. *Lung*, **1685**, 388–395.
- Toms, G.L. (1995) Respiratory syncytial virus—how soon will we have a vaccine? *Archives of Disease in Childhood*, **72**, 1–3.
- Toms, G.L., Quinn, R. and Robinson, J.W. (1996) Undetectable IgE responses after respiratory syncytial virus infection. *Archives of Disease in Childhood*, **74**, 126–130.
- Vaux-Peretz, F., Chapsal, J.M. and Meignier, B. (1992) Comparison of the ability of formalin-inactivated respiratory syncytial virus, immunopurified F, G, and N proteins and cell lysate to enhance pulmonary changes in Balb/c mice. *Vaccine*, **10**, 113–118.
- Walsh, E.E., Hall, C.B., Briselli, M. *et al.* (1987) Immunization with glycoprotein subunits of respiratory syncytial virus to protect cotton rats against viral infection. *Journal of Infectious Diseases*, **155**, 1198–1204.
- Welliver, R.C. and Duffy, L. (1993) The relationship of RSV-specific immunoglobulin E antibody responses in infancy, recurrent wheezing, and pulmonary function at age 7–8 years. *Pediatric Pulmonology*, **15**, 19–27.
- West, W.H., Lounsbach, G.R., Bourgeois, C. *et al.* (1994) Biological activity, binding site and affinity of monoclonal antibodies to the fusion protein of respiratory syncytial virus. *Journal of General Virology*, **75**, 2813–2819.

Adenoviruses

Göran Wadell

University of Umeå, Umeå, Sweden

INTRODUCTION

In an attempt to evaluate different tissues for growth of polio viruses, adenoids removed surgically from 53 children in Washington DC were explanted by Rowe and colleagues (1953). After an observation period of 4 weeks, 33 of the cultures showed a slowly progressive cytopathic effect. The agents isolated from these cultures were designated the adenoid-degenerating (AD) agent.

Adenoviruses were also soon established as the aetiological cause of acute respiratory disease by Hilleman and Werner (1954). Thus two of the fundamental properties of human adenoviruses, the acute respiratory infection and the persistent infection of lymphatic tissue, were recognized at an early stage.

Adenoviruses have been isolated from every species of the placental mammal, marsupial, bird and amphibian studied. The number of serotypes found reflect the effort spent on collection and typing of isolated strains. In humans 31 serotypes were identified by 1965; 49 different serotypes of human adenoviruses had been recognized up to 1993 (Table 8.1) (Schnurr and Dondero 1993). A clinical isolate is identified as a serotype on the basis of distinct antigenic epitopes which are capable of inducing neutralizing antibodies. However, cross-neutralization studies with 47 serotypes have shown that significant cross-reactions occur between a number of serotypes, particularly within subgenera (Hierholzer *et al.*, 1991).

Recent methods for the identification of DNA

viruses by use of restriction enzyme have also been applied. These methods are straightforward and can be of help when ambiguous results are obtained from serotyping attempts. In addition, application of such techniques to clinical isolates opens up the new field of molecular epidemiology and allows probing of the genetic variability expressed within each adenovirus serotype.

Six subgenera of human adenoviruses have been identified. Members of different subgenera display a low DNA homology to members of other subgenera. Distinct disease patterns for members of each subgenus can often be defined.

THE VIRUSES

Physicochemical Structure

The adenovirus particles are non-enveloped icosahedrons with a diameter of 80 nm (Figure 8.1). The virion is composed of at least 10 different structural polypeptides. The virus capsid is formed by 252 capsomers. Among these, 240 capsomers (the hexons) are symmetrically arranged so that each is surrounded by six other capsomers. Each hexon is formed from three copies of polypeptide II. The 12 vertices of the virion contain a capsomer from which an antenna-like projection (fibre) extends. The vertex capsomers together with their projections are called pentons because they are surrounded by five capsomers and exhibit fivefold symmetry. It has been suggested that each penton

Table 8.1 Human adenovirus serotypes

Prototype			
Type	Strain	Source	Diagnosis
1	Ad71	Adenoid	Hypertrophied tonsils and adenoids
2	Ad6	Adenoid	Hypertrophied tonsils and adenoids
3	GB	Nasal washing	Common cold (volunteer)
4	RI-67	Throat washing	Primary atypical pneumonia
5	Ad75	Adenoid	Hypertrophied tonsils and adenoids
6	Ton 99	Tonsils	Hypertrophied tonsils and adenoids
7	Gomen	Throat washing	Pharyngitis
7a	S-1058	Throat swab	Undifferentiated respiratory infection
8	Trim	Eye swab	Epidemic keratoconjunctivitis
9	Hicks	Stool	Rheumatoid arthritis?
10	JJ	Eye swab	Conjunctivitis
11	Slobitski	Stool	Paralytic polio (type 1 poliovirus also recovered)
12	Huie	Stool	Non-paralytic polio?
13	AA	Stool	Healthy child
14	DeWitt	Throat swab	Acute respiratory disease
15	Ch38	Eye swab	Conjunctivitis (early trachoma?)
16	Ch79	Eye swab	Conjunctivitis (early trachoma?)
17	Ch22	Eye swab	Conjunctivitis (early trachoma?)
18	DC	Anal swab	Niemann–Pick disease?
19	587	Conjunctiva	Trachoma
20	931	Conjunctiva	Early trachoma?
21	1645	Conjunctiva	Trachoma
22	2711	Conjunctiva	Trachoma
23	2732	Conjunctiva	Trachoma
24	3153	Conjunctiva	Trachoma
25	BP-1	Anal swab	No specific illness
26	BP-2	Anal swab	No specific illness
27	BP-4	Anal swab	No specific illness
28	BP-5	Anal swab	No specific illness
29	BP-6	Anal swab	No specific illness
30	BP-7	Anal swab	No specific illness
31	1315/63	Stool	Healthy child
32	HH	Anal swab	Healthy child
33	DJ	Anal swab	Healthy child
34	Compton	Urine	Renal transplant recipient
35	Holden	Lung and kidney	Renal transplant recipient
36	275	Stool	Enteritis
37	GW	Eye	Keratoconjunctivitis
38	LJ	Anal swab	Bronchopneumonia
39	D335	Stool	Bronchitis
40	Dugan/ HoviX	Stool	Gastroenteritis
41	Tak	Stool	Gastroenteritis
42	54t82	Stool	Healthy child
43	1309	Rectal swab	AIDS
44	1584	Stool	AIDS
45	1590	Stool	AIDS
46	1594	Stool	AIDS
47	1601	Stool	AIDS

capsomer is formed by five copies of polypeptide III.

The fibres are glycoproteins and display a characteristic varying length in adenoviruses belonging

to various subgenera. Each fibre is a trimer of polypeptide IV.

The polypeptides IIIa, VI, VIII and IX connect hexons and vertex capsomers into a dense capsid.

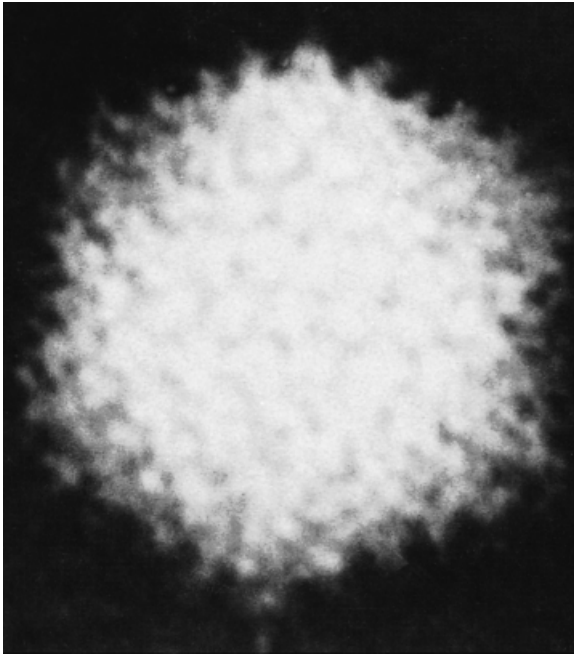

Figure 8.1 Electron micrograph of *Human adenovirus 4*

This capsid contains a nucleoprotein complex which is composed of polypeptides V and VII and a linear double-stranded DNA molecule containing 33–45 kb pairs. The ends of linear DNA molecules are covalently bound to a protein with a molecular mass of 55K. The adenovirus particle is stable to low pH, bile and proteolytic enzymes. For these reasons, adenoviruses can replicate to high titres in the intestinal tract.

Replication

Replication of DNA, transcription and maturation of adenovirus take place in the cell nucleus. The spliced mRNA is translated in the cytoplasm.

Infection by Ad2 and Ad5 is initiated by attachment of the fibre to CAR, a glycoprotein of the immunoglobulin superfamily (Bergelson *et al.*, 1997). The penton base then binds to the second receptor, the fibronectin binding integrin $\alpha v\beta 3$ or $\delta v\beta 5$ (Wickham *et al.*, 1994). This initial step of the infection cycle may account for the distinctly different tropisms of adenoviruses of different subgenera. Penetration of virions occurs by an incompletely understood mechanism. Cell-associated adenovirus

particles are taken into endosomes by absorptive endocytosis. An ATP-driven protein pump lowers the pH within the endosome, resulting in a hydrophobic alteration to the surface of the adenovirus capsid.

Penetration of the lipid bilayer by the virion appears to cause disruption of the endosome, allowing the capsid to be transported to the cell nucleus (Varga *et al.*, 1991). The viral cysteine protease is activated by the reducing environment of the host cell and degrades protein VI which anchors the viral DNA to the capsid (Gerber *et al.*, 1996). The viral capsid is transported to a nuclear pore via microtubules. The remaining capsid is lost during the deposition of the virus core into the cell nucleus. Transcription and DNA synthesis of adenovirus occur in the nucleus.

Six different early transcription regions have been identified. Transcription is initiated by early region E1A which contains enhancer-like structures. Both regions E1A and E1B are needed for the expression of other viral genes and are also required for adenovirus transformation. Regions E2A and E2B encode several proteins which are required for viral DNA replication. The E3 region can be regarded as a cassette containing immunomodulating peptides, e.g. the 19 kDa glycoprotein, which binds the heavy chain of MHC I, thus impairing its glycosylation and transport to the cell surface. Several of the open reading frames (ORFs) in the E3 region have a structure compatible with membrane proteins and are translated into peptides that have immune modulating functions. The E3 14.7 kDa and the E3 10.4/14.5 kDa protein inhibit tumour necrosis factor (TNF)-induced apoptosis and TNF-induced release of arachidonic acid.

Several other early virus-specific proteins are formed before viral DNA synthesis can be initiated. This occurs 7 hours after infection. Five hours later the synthesis of virus structural proteins can be initiated. The synthesis of the cellular proteins then gradually ceases.

Newly formed virus structural polypeptides are transported within a few minutes into the nucleus, where the assembly of virus particles starts 7 hours after the initiation of DNA synthesis. Up to 10^5 virus particles are assembled in each cell within 30 hours after infection with the most rapidly growing types of human adenoviruses. The proportion of infectious particles among these varies with different serotypes from 1 in 10 to 1 in 10000. The transla-

tion of viral mRNA coding for structural proteins continues uninterrupted for about 40 hours. This results in an accumulation of a tenfold excess of viral polypeptides. Efficient release of virions requires expression of E3 11.6 kDa adenovirus death protein (ADP) (Tollefson *et al.*, 1996).

Classification of the 49 Human Adenoviruses into Six Subgenera

Human adenoviruses were originally classified by Rosen (1960) into four groups, I–IV, based on different haemagglutination properties with rat and rhesus monkey erythrocytes. Although the portion of the genome coding for the receptor-binding sites of the adenovirus fibre represents only a fraction of the total adenovirus genome, this property is apparently critical and a large number of other biological properties are shared by adenoviruses grouped together according to Rosen. The importance of genes coding for fibre proteins in the classification of adenoviruses is also illustrated by the fact that adenoviruses belonging to different subgenera display characteristic differences in the length of their fibres. The charge, i.e. the isoelectric point of the fibre knobs, varies from 4.5 (Ad35) to 9.5 (Ad37).

It was suggested in 1967 that human adenoviruses could be divided into subgenera on the basis of their oncogenicity in newborn hamsters. Subgenus A comprises adenovirus serotypes which are highly oncogenic, i.e. causing tumours in every animal within 2 months. Subgenus B adenoviruses are weakly oncogenic, meaning that few of the animals developed tumours after an observation period of 1 year. The non-oncogenic adenoviruses can transform rodent cells *in vitro* and are divided into subgenera C and D on the basis of differences in the antigenicity of the early T antigen.

The polypeptides of the virion represent a major portion of the products of the adenovirus genome. Internal polypeptides would be expected to be more conserved and offer a means of classifying human adenoviruses. The 49 human adenovirus serotypes could be divided into six subgenera by SDS-polyacrylamide gel electrophoresis of virion polypeptides (Wadell *et al.*, 1980a). This method was compatible with the previous methods, and extended these as regards Ad4 (subgenus E) and the newly identified enteric Ad40 and Ad41 (subgenus F) (Table 8.2).

In general, the critical classification of viruses should be based on nucleotide sequence differences between genomes from different viruses. DNA homology of adenoviruses has been studied by filter hybridization and liquid hybridization (Green *et al.*, 1979). The classification of adenoviruses by this means is in complete agreement with the data obtained by classification of human adenoviruses based on the molecular weight of the internal structural polypeptides of the virion. Human adenoviruses display characteristic differences in the G-C content in their DNA, subgenus A (47–49%), subgenus B (49–52%), subgenus F (52%). This difference can be exploited by using SmaI DNA restriction endonuclease that cleaves at 5'CCC GGG (Wadell *et al.*, 1980a).

SmaI has been used to obtain DNA restriction patterns of 41 human adenovirus serotypes (Figure 8.2). It should be noted that a limited range of the number of SmaI fragments of the adenovirus genomes is characteristic for each subgenus. Furthermore, the restriction patterns of the adenovirus types belonging to the same subgenus display a high proportion of comigrating DNA restriction fragments. In the case of the heterogeneous subgenera A, B and F, clusters of DNA restriction patterns are revealed. In general, there is comigration of more than 50% of DNA restriction fragments of adenoviruses belonging to the same subgenus or the same cluster, whereas pairwise comparison of genomes classified into different subgenera reveals that less than 10% of the DNA restriction fragments comigrate.

It is evident that the access to DNA restriction patterns of adenovirus prototypes provides efficient means of identification and classification of unknown strains and can reveal the existence of genetic variability within one serotype (Adrian *et al.*, 1986).

Genetic variability has been demonstrated within each adenovirus serotype studied. Four genome types of Ad3 and 12 of Ad7 have been detected among more than 700 wild-type strains recovered from different parts of the world by using only two restriction enzymes, SmaI and BamHI (Figure 8.3). This technique allows the introduction of molecular epidemiology into the study of adenovirus infections and is a tool which can be used with others in attempting to distinguish between virulent and less virulent adenovirus strains. Phylogenetic studies based on the ITR and VA-RNA genes showed that

Table 8.2 Properties of human adenovirus serotypes of subgenera A to F

Sub genus	Serotype	Homology (%)			Apparent molecular mass of the major internal polypeptides (kDa)			Haemagglutination pattern ^b	Length of fibres (nm)	Oncogenicity in newborn hamsters	Tropism symptoms	
		Intragenomic	Intergeneric	G + C (%)	Number of Small ^a fragments	V	VI					VII
A	12,18,31	48–69	8–20	48	4–5	51.0–51.5 46.5–48.5 ^c	25.5– 26.0	18	IV	28–31	High (tumours in most animals in 4 months)	Cryptic enteric infection
B:1	3,7,16,21,	89–94	9–20	51	8–10	53.5–54.5	24	18	I	9–11	Weak (tumours in few animals in 14–18 months)	Respiratory disease
B:2	14, ^d 11, 34, 35											Persistent infections of the kidney
C	1, 2, 5, 6	99–100	10–16	58	10–12	48.5	24	18.5	III	23–31	Nil	Respiratory disease persists in lymphoid tissue
D	8–10, 13,15, 17, 19, 20, 22–30, 32, 33, 36, 37, 38, 39, 42–47 ^e	94–99	4–17	58	14–18	50–50.5 ^f	23.2	18.2	II	12–13	Nil	Keratoconjunctivitis
E	4		4–23	58	16–19	48	24.5	18	III	17	Nil	Conjunctivitis
F	40, 41	62–69	15–22	52	9–12	46.0–48.5	25.5	17.5	IV	28–33	Nil	Respiratory disease Infantile diarrhoea

^aThe restricted DNA fragments were analysed on 0.8–1.2% agarose slab gels. DNA fragments smaller than 400 bp were not resolved.

^bI, Complete agglutination of monkey erythrocytes; II, complete agglutination of rat erythrocytes (fewer receptors); IV, agglutination of rat erythrocytes discernible only after addition of heterotypic antisera.

^cPolypeptide V of Ad31 was a single band of 48 kDa.

^dMembers of subgenus B are divided into two clusters of DNA homology based on pronounced differences in DNA restriction sites.

^eOnly polypeptide analysis and/or DNA restriction analysis has been performed with Ad32–Ad39 and Ad42–Ad47.

^fPolypeptides V and VI of Ad8 showed apparent molecular mass of 45 and 22 kDa, respectively. Polypeptide V of Ad30 showed an apparent molecular mass of 48.5 kDa. Modified from Wadell (1984).

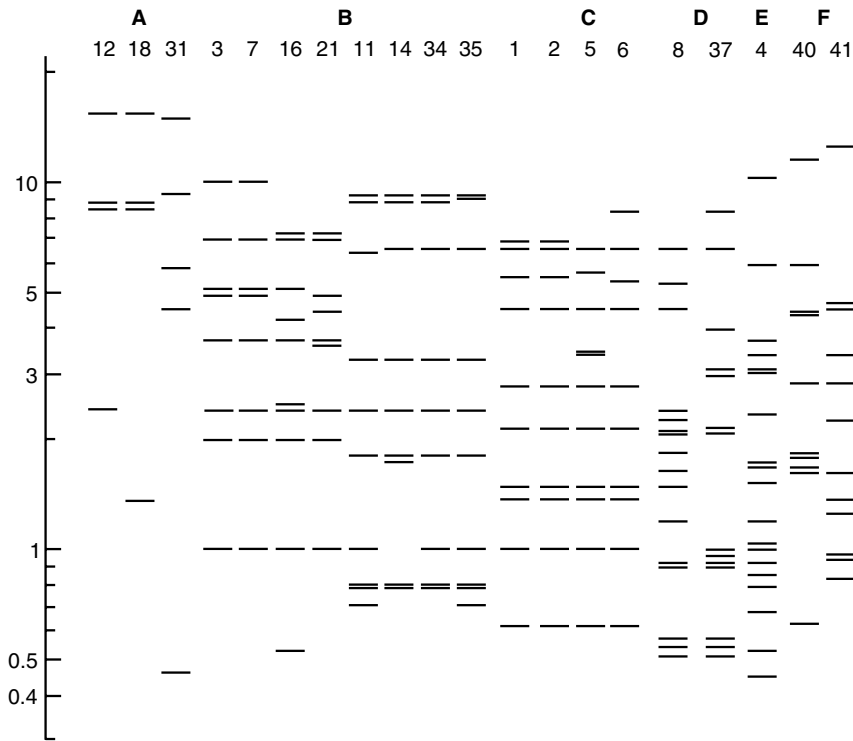

Figure 8.2 Schematic presentation of SmaI DNA restriction patterns obtained after cleavage of DNA from adenovirus prototypes belonging to subgenera A, B, C, D, E and F

simian adenoviruses were closely related to members of the different subgenera of human adenoviruses (Bailey and Mautner, 1994; Kidd *et al.*, 1995).

Taxonomic Terminology

It is clear from the above that the classification of adenoviruses has evolved from schemes based on biological properties to a reproducible and discriminating system based on genomic differences. It is advisable at this stage to list some definitions.

Members belonging to the genus of adenoviruses share common epitopes on the hexons. *Subgenus* is defined by the DNA homology of more than 50% between members within a subgenus and less than 20% between members of different subgenera. The *serotype* is defined by quantitative neutralization with hyperimmune sera. A ratio of homologous to heterologous neutralization titre must be greater than 16. The designation *recombinant* should be

used only when the two parent genomes have been identified. An *evolutionary variant* is one in which genetic alteration was generated via insertion or intragenomic recombination in progeny of the same strain. A *genomic cluster* is a group of genome types that are significantly more closely related to each other than to any other genome type. The *genome type* denotes a distinct viral entity within a genomic cluster identified by DNA restriction analyses. *Strain* corresponds to the progeny of each wild-type isolate.

As more DNA variants have been discovered and studied in greater detail, their classification has become more complex and their relatedness with each other better understood. There has been some confusion due to different working groups using the same letters and numbers for quite different genome types (Wigand and Adrian, 1991). The adoption of a unified system will require the renaming of some genome types.

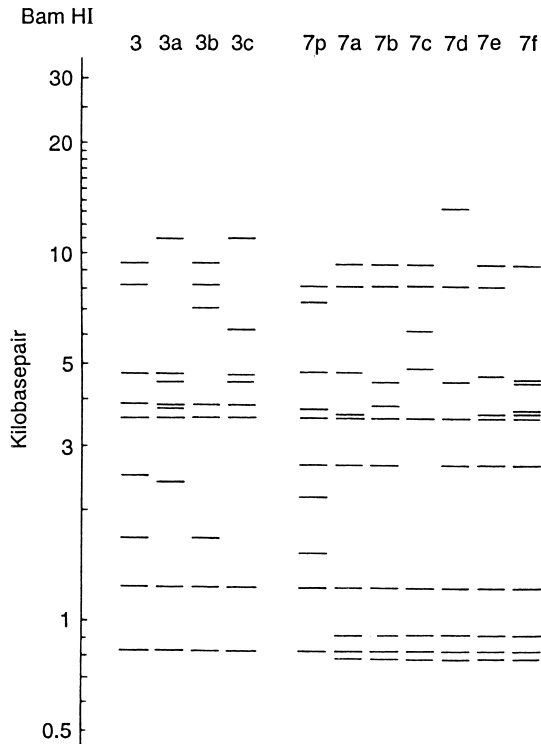

Figure 8.3 Schematic presentation of BamHI DNA restriction patterns obtained after cleavage of DNA from Ad3 and Ad7 genome types

PATHOGENESIS

The propensity of adenoviruses to shut off expression of the host mRNA, and the unregulated excess synthesis of adenovirus structural proteins, results in accumulation of viral proteins as intranuclear inclusion bodies which are incompatible with normal cell function (Figure 8.4). This will give rise to the characteristic histopathological intranuclear inclusions in the alveolar cells in a severe adenovirus pneumonia. In the upper respiratory tract cells, ciliary abnormalities and microtubular aberrations lead to a defective mucociliary clearance (Carson *et al.*, 1985).

Differences in target cell specificity between the adenovirus fibres can contribute to the distinctly different tropisms of members of the six different adenovirus subgenera. Furthermore, a toxin-like activity has been associated with vertex capsomers—the base of the penton. Isolated penton

bases can cause cell detachment of monolayer cell cultures after 2 hours incubation. This activity is particularly strong in preparations from adenoviruses of subgenera B and C. In addition, the adenovirus capsid and/or pentons exert a direct effect on the lipid bilayer of the endosome, allowing the release of endosome content into the cytosol. However, the gene products of the adenovirus genome responsible for the adenovirus-induced symptoms in the host are, on the whole, not defined.

Ad1, Ad2 and Ad5, members of subgenus C, persist in tonsils for several years, through a low-grade replication. Whether only a subset of lymphocytes is infected is not known. Shedding of infectious virus in stools for at least 2 years has also been documented (Fox and Hall, 1980). The source may be Peyer's patches of lymphoid tissue in the gut but this has not been demonstrated.

The mimicry such as the immunological cross-reactivity between gliadin and the Ad12, E1B, 54K protein has yet to be critically evaluated in relation to sequelae of adenovirus infections of the gut.

Members of subgenus B:2, Ad11, Ad34 and Ad35 cause persistent infections of the kidney. Silent shedding of Ad11 for 6 months into the urine of a healthy pregnant woman has been documented by Gardner (personal communication). Ad11 has also been demonstrated to be transmitted via the kidney, giving a haemorrhagic cystitis in a transplant recipient. These serotypes are also activated in AIDS patients and bone marrow transplant recipients.

Animal models for human adenovirus infections are available, such as hepatitis induced by *Human adenovirus 5* in the mouse and pneumonia induced by *Human adenovirus 5* in cotton rats.

EPIDEMIOLOGY

General

Information on the role of adenoviruses in viral respiratory diseases has been gathered in series of reports to the World Health Organization (WHO). Reports of adenovirus isolation to the WHO register have been evaluated over a 10-year period (1967–1976) (Schmitz *et al.*, 1983). During this 10-year period adenoviruses accounted for 13% of a total of 135 702 reported isolations. Adenovirus infections were second only to influenza A, which

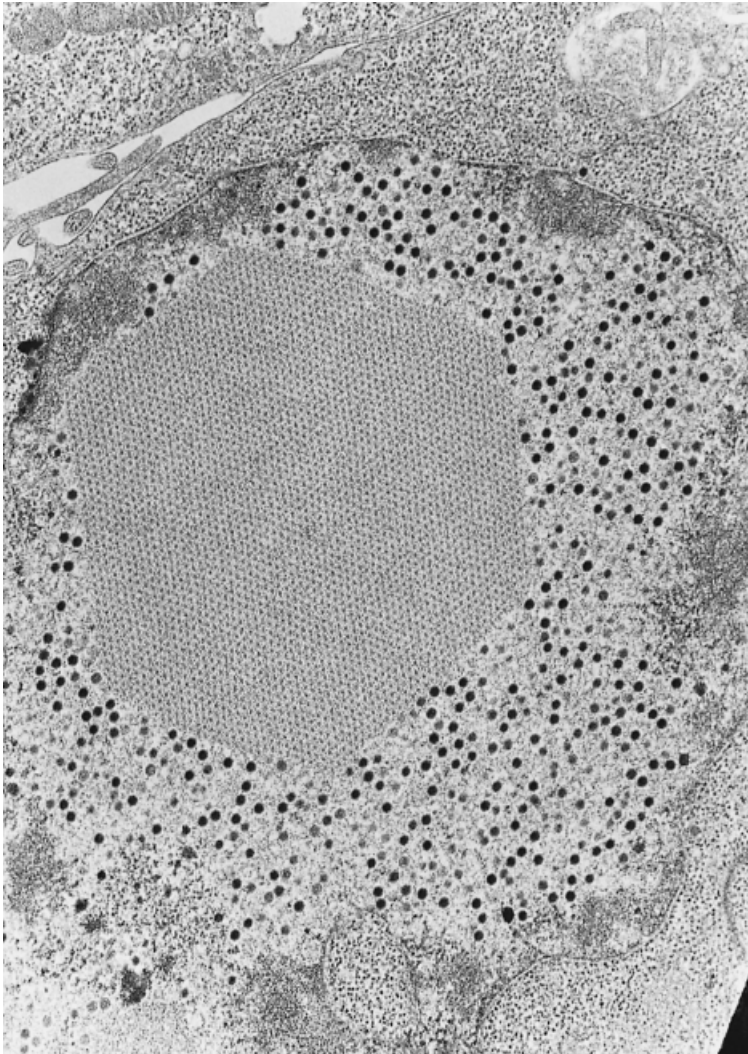

Figure 8.4 Intranuclear inclusion of an Ad5-infected KB cell 48 hours after infection. (Reproduced with permission from R. Marusyk *et al.* (1972) *Journal of General Virology*, **14**, 261–270)

represented 28% of the reported isolates.

A stratification of the reported adenovirus isolations by age revealed the following: 22% (< 1 year); 42% (1–4 years); 18% (5–14 years); 10% (15–24 years); 7% (25–29 years); 1% (> 30 years). Between 47 and 55% of the infections resulted in an illness so slight that it escaped attention. Fox and Hall (1980) have concluded on the basis of seroconversion that the true contribution of adenoviruses to illness is double that usually estimated on the basis of virus isolation alone.

Members of different adenovirus subgenera show distinctly different organ tropisms. Consequently, it

is valid to present the epidemic distribution according to subgenus.

Subgenus A

Ad12, Ad18 and Ad31 represent only 0.5% of the reported typed virus isolates. Members of subgenus A share several properties with the enteric adenoviruses and are otherwise distinguished from all other adenovirus serotypes by three characteristics: (1) the majority of isolates have been obtained from

0–12-month-old infants; (2) 91% of the reported isolates were recovered from stools; and (3) 60% of the children had a gastrointestinal disease. In the absence of information on the serological response of children shedding adenoviruses of subgenus A, it is difficult to evaluate their role as a cause of diarrhoea.

Infections with subgenus A members are relatively common. An extensive study of the prevalence of neutralizing antibody in children in Rome demonstrated that Ad31 and Ad18 were second only to members of subgenus C and Ad3. The use of the SmaI DNA restriction patterns (Figure 8.2) is of value in the identification of Ad12, Ad18 and Ad31, as they cross-react in both neutralization and haemagglutination-inhibition assays.

Subgenus B

DNA restriction analysis has revealed that this subgenus should be divided into two clusters of DNA homology.

DNA Homology Cluster B:1

The members of this cluster are associated with respiratory infections. Ad3 and Ad7 account for 13% and 19.7% of all adenovirus isolates typed and reported to WHO. Both Ad3 and Ad7 show an epidemic appearance with 4–5-year intervals. Both serotypes are most frequently isolated from children below the age of 4 years.

Three different epidemic patterns of Ad7 infection have been identified. The first pattern consists of outbreaks mainly in the winter season among infants. These infections may be severe, and fatal among institutionalized children. The second pattern consists of epidemic outbreaks of respiratory disease among schoolchildren. Severe infections with fever for 7 days are usually encountered but a fatal outcome is rare. The third pattern is seen as the outbreaks among newly enlisted military recruits.

It is evident from the WHO register that pronounced differences prevail in the frequency of isolation of different adenovirus serotypes from different regions of the world. The frequency of reported Ad7 isolates in Japan and the antibody prevalence were highly discordant. Ad7-specific antibodies were detected in 30% of the children and in 50% of

adult sera. However, in Japan only 2% of the adenovirus strains were typed as Ad7, whereas 52% of the isolates were typed as Ad3. Recently an outbreak of Ad7h infectious has emerged in Japan.

The situation in Europe is different; thus in the former West Germany Ad3 and Ad7 accounted for 11% and 25%, respectively, of typed adenoviruses. The Japanese strains were genome typed as the Ad7 prototype, which appears to be of low virulence. Isolation frequency may be influenced by the severity of virus-associated diseases and perhaps also by the tendency of virus strains to cause persistent infections with shedding of infectious virus over extended periods.

DNA restriction analysis of adenovirus strains can reveal the genetic variability within each serotype (Wadell, 1984). This is best exemplified by the analysis of Ad7. Twelve distinct genome types of adenovirus 7 – Ad7p, Ad7a, Ad7b, Ad7c, Ad7d, Ad7e, Ad7f, Ad7g, Ad7h, Ad7i, Ad7j, Ad7k—were identified by using the restriction endonucleases BamHI and SmaI (Azar *et al.*, 1998). The worldwide distribution of the different Ad7 genome types is shown in Figure 8.5. In Africa, type Ad7c predominated. In Australia, the distribution of the Ad7 genome types was similar to that in Europe, the difference being that a shift from Ad7c to Ad7b took place in 1975. In Brazil, Ad7e was the only genome type detected and this genome type was unique to Brazil. In China, severe outbreaks of Ad7-associated respiratory disease with mortality among infants have been reported. Three strains recovered from autopsy cases in 1958 were genotyped as Ad7a. A11 strains which have been genotyped during the last years were identified as Ad7d, this genome type being unique to China. In Europe more than 90% of all isolates from patients were genotyped as Ad7b and Ad7c. These two appear to be mutually exclusive, a shift from Ad7c to Ad7b occurring in 1969. In the USA, Ad7b strains have predominated among the Ad7 isolates collected on the west coast since 1962. Ad7p and Ad7a strains were detected among Ad7 isolates recovered through the Virus Watch Program in Seattle, Washington. During an outbreak of respiratory disease in the South Cone of South America (1984–1994), 537 adenovirus strains from hospitalized children with ALRI were analysed: 63% represented subgenus B; 281/338 strains were typed as the newly emerging Ad7h genome type associated with 32/33 fatalities. Kajon *et al.* (1996). In Ad7h the

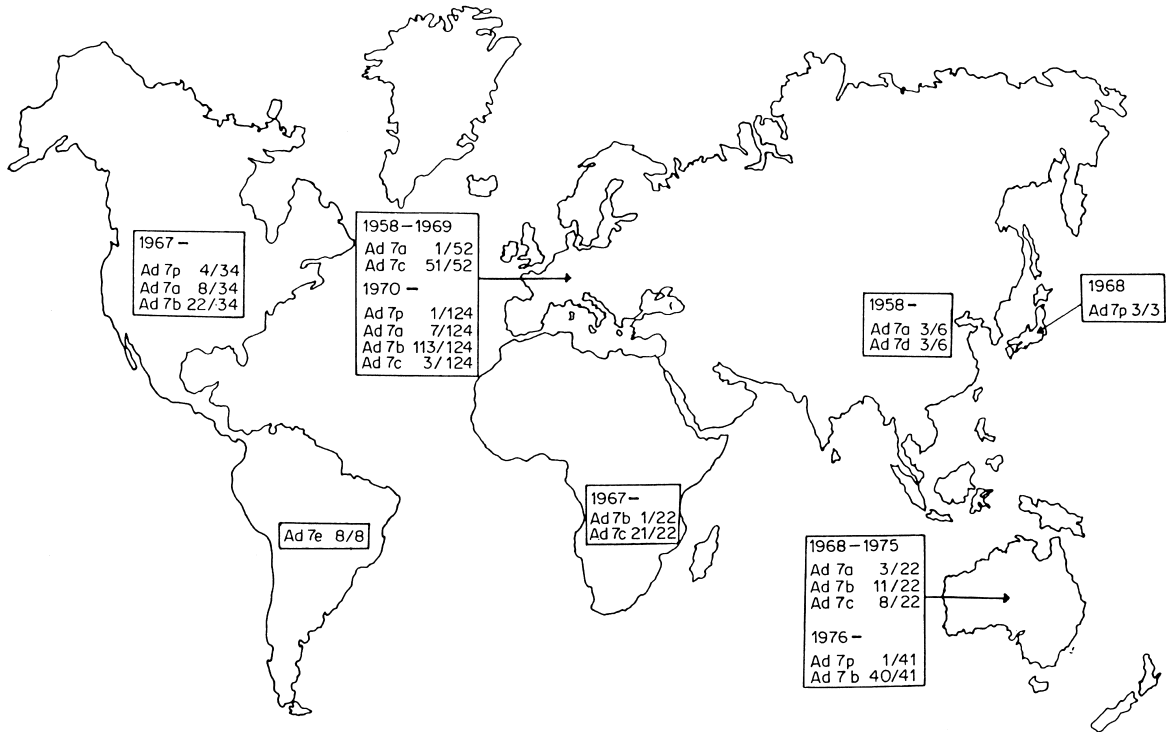

Figure 8.5 Worldwide distribution of different adenovirus 7 genome types. (Reproduced with permission from G. Wadell *et al.* (1985). *Journal of Clinical Microbiology*, **21**, 403-408)

Ad3 fibre had recombined into the Ad7 genome (Kajon and Wadell, 1996).

Seventeen genome types of Ad3 have been identified (Li and Wadell, 1988). The Ad3 prototype predominated in Europe, Brazil, Africa and Australia, whereas strains genome typed as Ad3a were found in China, Japan, USA and recently also in Europe. No mutually exclusive shift between genome types could be detected among Ad3 isolates.

Of the remaining members of DNA homology cluster B:1, Ad16 can be associated with conjunctivitis, whereas Ad21 can cause severe respiratory disease. Ad21 has been isolated from military recruits at all major basic training centres in the US Army, which has prompted the introduction of a live Ad21 vaccine.

DNA Homology Cluster B:2

Ad11, Ad14, Ad34 and Ad35 account for less than 1% of reported adenovirus isolates. The prevalence of antibodies against Ad11 among Italian children is about 2%. Ad14 differs from the other members

and has been reported to cause outbreaks of respiratory disease among military recruits. Ad11, Ad34 and Ad35 are closely related and can cause persistent infections of the kidneys, and possibly also of other parts of the urinary tract. Ad11 has been demonstrated to cause haemorrhagic cystitis. The persistent nature of these adenoviruses is also well illustrated by the fact that they are the most common adenoviruses to be isolated from patients with the acquired immune deficiency syndrome (AIDS) or from bone marrow transplant recipients.

Subgenus C

The subgenus C members account for 50% of all adenovirus strains reported to WHO. The relative frequencies are 25.4, 20.4, 11 and 2.4% for Ad2, Ad1, Ad5 and Ad6, respectively. They are most frequently isolated in children under the age of 4 years. Distinct epidemics of genome types of these adenoviruses occur. Among children below the age

of 5, 50–70% have antibodies against the most commonly detected Ad1 and Ad2 (Fox and Hall, 1980).

The subgenus C adenoviruses have been designated endemic adenoviruses, due to their propensity to cause persistent infections and shedding for years in stools. The infection can be perpetuated within families, being spread to the newly born child of the family. Because these adenoviruses are harboured in the tonsils and shed from the gut, superinfections occur frequently and a vast number of genome types of the four serotypes have been demonstrated. Adenovirus 5 is of particular interest, as this virus can cause severe infections in immunocompromised hosts.

Subgenus D

Subgenus D contains 31 serotypes, i.e. more than half of all recognized human adenoviruses. However, only 4.1% of all typed adenovirus strains reported to WHO belong to subgenus D. It should be emphasized that the global situation for these adenoviruses is not well mirrored by the WHO register. Infections caused by members of subgenus D are more common in Asia and Africa. Ad8 is the classic cause of epidemic keratoconjunctivitis (Jawetz, 1959).

Ad19 was isolated in Saudi Arabia in 1955 from a child with trachoma. This type was not reported again until 1975 when several epidemic outbreaks of keratoconjunctivitis caused by Ad19 appeared in both Europe and the USA. These outbreaks were demonstrated to be caused by a new genome type, Ad19a, which was distinctly different from the original Ad19 prototype. In 1976 a new adenovirus type Ad37, related to Ad19a, appeared. Ad37 is now an important cause of keratoconjunctivitis. This type may also appear as sporadic infections. Furthermore, Ad37 may be sexually transmitted, as Ad37 isolates from penile lesions and cervicitis are reported. The fibre genes of Ad19a and Ad37 are identical (Arnberg *et al.*, 1997). These three serotypes are the predominant pathogens of adenovirus-associated keratoconjunctivitis in Western countries. In Japan, Ad3, Ad4, Ad8, Ad19 and Ad37 have been demonstrated to cause 39% of the virus infections of patients treated at an eye hospital.

Subgenus E

Adenovirus 4 is the only member. Ad4 is rarely isolated from children in Europe or the USA, being detected in only four children out of 1800 with proven adenovirus disease. Ad4 accounts for 2.4% of the adenovirus isolates reported to WHO. Most isolates were obtained from adults, and the frequency of Ad4 from adults was superseded only by the serotypes of subgenus D. The prevalence of Ad4-specific antibodies among adults is 30, 50 and 60% in the USA, Japan and Taiwan, respectively. Two strikingly dissimilar genome types of adenovirus 4, the Ad4 prototype and Ad4a, have been demonstrated by DNA restriction analysis. The Ad4 prototype has been isolated from military recruits and identified as a cause of the characteristic epidemic outbreaks of respiratory disease. The Ad4a genome type is commonly isolated in Japan as a cause of conjunctivitis. Ad4a was identified in outbreaks of eye disease causing acute haemorrhagic conjunctivitis with subconjunctival haemorrhage in Rome in 1974. In 1977, a 5-year-old boy died with disseminated Ad4 infection after treatment at an intensive care unit in Buffalo, New York. A nosocomial outbreak of pharyngoconjunctival fever affected 35 of his attendants at the hospital. All the Ad4 strains were genome typed as Ad4a. In Japan, Ad4 is second only to Ad8 as a cause of adenovirus-associated eye disease. During the period 1967–1976 only seven Ad4 strains associated with eye disease were reported to the WHO register. However, during recent years several reports on Ad4-associated conjunctivitis have appeared, 12 genome subtypes being isolated from outbreaks occurring between 1985 and 1989 in Sapporo, Japan (Itakura *et al.*, 1991).

Subgenus F

The enteric adenoviruses Ad40 and Ad41 are the only members of subgenus F. They are shed in large amounts (10^{11} virus particles per gram of faeces) from children with diarrhoea. In contrast to rotaviruses, enteric adenoviruses cause diarrhoea in children throughout the year. Outbreaks have been reported from hospitals and boarding schools. Ad40 and Ad41 do not share the property of adenoviruses of subgenus C which can be shed for long

Table 8.3 Illnesses associated with adenovirus infections

Disease	Individuals at risk	Principal serotypes
Acute febrile pharyngitis	Infants, young children	1, 2, 3, 5, 7
Adenopharyngoconjunctival fever	School-age children	3, 7
Acute respiratory disease with pneumonia	Military recruits	4, 7, 14, 21
Pneumonia	Infants, young children	1, 2, 3, 7
Follicular conjunctivitis	Any age group	3, 4, 11
Epidemic keratoconjunctivitis	Predominantly adults	8, 19, 37
Pertussis-like syndrome	Infants, young children	5
Acute haemorrhagic cystitis	Infants, young children	11, 21
Diarrhoea	Infants, young children	40, 41
Intussusception	Infants	1, 2, 5
AIDS and other immunosuppression	Homosexuals, intravenous drug abusers, renal and bone marrow transplant recipients	5, 31, 34, 35

Modified from Horwitz (1985).

periods into the stools. Enteric adenoviruses cannot be found in stools from healthy controls. In a prospective study in Uppsala in 1981, Ad40 and Ad41 accounted for 8% of the children seeking hospital care for diarrhoea. Seroconversion could be demonstrated in 70% of the patients (Uhnoo *et al.*, 1984).

Ad40 and/or Ad41 have been isolated in stool specimens from Africa, Asia, Europe, Latin America and North America. About 50% of 6- to 8-year-old children in Africa, Asia and Europe have neutralizing antibodies against Ad41. In Europe during the 1980s, the relative incidence of Ad41 compared with Ad40 infections increased from 30% to 90–95%. During this same period Ad41/M3 superseded Ad41/M1 and Ad41/M2 as the major genome type isolated (De Jong *et al.*, 1993).

CLINICAL SYNDROMES

Table 8.3 lists the clinical syndromes associated with adenovirus infection and the principal serotypes involved.

Respiratory Disease in Children

Adenoviruses are responsible for 5% of acute respiratory infections in children under the age of 4 years, whereas they account for about 10% of hos-

pitalized respiratory infections in this age group. Characteristic symptoms are pharyngitis with an exudative tonsillitis and frequently conjunctivitis, together with nasal congestion and cough. In some children the diseases can be difficult to distinguish from group A streptococcal tonsillitis. Children usually have elevated temperature, myalgia and headache.

Adenoviruses can also cause laryngotracheobronchitis, but the pneumonias which occur in young children are the most serious clinical manifestations. These may occur as a consequence of infection with the endemic Ad2 and Ad5, among which certain strains (genome types) can be more aggressive than others. In particular, Ad3 and Ad7, which appear in epidemic outbreaks due to the low herd immunity, may also result in severe infections. Adenoviruses have been reported to account for 10% of pneumonias in childhood. The clinical symptoms are characterized by fever, cough, dyspnoea and respiratory wheezing. Severity of the infections is often related to overcrowding, and infections occur preferentially among institutionalized children. In the winter of 1959, 3398 cases of adenovirus pneumonia with a fatality rate of 15.5% were seen at a Peking children's hospital. Fatal cases among children below the age of 2 have also been reported from France, Germany, the Netherlands, Finland, Canada and the USA (review by Wadell *et al.*, 1980b). Eight studies performed between 1958 and 1988 on patients in China, the majority of whom had adenovirus-associated pneumonia, revealed

that 82% of the 1878 strains were typed as Ad3 or Ad7 (reviewed in Li *et al.*, 1996).

Among the survivors of severe respiratory infections, in particular among Inuits in Canada, Indians in the USA and Polynesians in New Zealand, residual lung damage thought to be due to secondary obliterative bronchiolitis has been reported. Furthermore, a so-called hyperlucent lung disease has been traced back to adenovirus infections in reports from Canada. The most common serotypes involved in this condition are Ad3, Ad4, Ad7 and Ad21 representatives of subgenera B and E.

In a prospective 10 year follow-up study from Finland, Simila *et al.* (1981) reported sequelae after Ad7 pneumonia: 22 children were examined 10.7 years after the pneumonia; 12 had abnormal chest X-ray (six with bronchiectasis) and in 16 the results of pulmonary function tests were abnormal. This is in agreement with the sequelae reported from North American Indians or Inuits. In all these studies children below the age of 2 were more prone to develop both severe primary infections, occasionally with a fatal outcome, and long-term sequelae.

Adenoviruses can also be a severe threat to children in developing countries who are exposed to measles infections. In a series of autopsies on children dying from respiratory disease after measles in South Africa, adenovirus pneumonias were considered to be the cause of death in one-quarter.

Adenovirus 7 sometimes appears in clear-cut outbreaks which may involve children of school age. In such cases a high fever with a mean duration of 7 days, bronchopneumonia, gastroenteritis and meningism may occur, but the outcome is generally favourable.

Pharyngoconjunctival Fever

This disease, first reported among those using swimming pools, is characterized by conjunctivitis, fever, pharyngitis and adenoidal enlargements. Ad3 and Ad7 are most frequently associated with this syndrome, whereas Ad4 is common in Asia but unusual among children in Western countries. Adequate levels of chlorine are usually sufficient to inhibit outbreaks connected with the use of swimming pools.

Acute Respiratory Disease (ARD) in Military Recruits

ARD is usually caused by Ad4, Ad7 and Ad21. Ad14 has been reported from Holland. Ad3 is much more rarely isolated, probably because of the more extensive herd immunity against this virus. In general, outbreaks do not involve seasoned troops but cause a high morbidity among newly enlisted recruits. Adenovirus infections among healthy civilian adults are much less common. Crowding of people from widely different parts of the country, allowing repeated exposure to highly infectious doses, and the strenuous physical exercise may account for the unusually high degree of severe infections among recruits, some of which may have a fatal outcome. ARD usually appears during the third week in training. Characteristic symptoms include fever for at least 4 days, malaise, headache, nasal congestion, sore throat, hoarseness and cough. About 10% develop patchy pulmonary infiltrates.

Cases of adenovirus pneumonia display characteristic histopathological features, with bronchiolitis and retracted intranuclear inclusion bodies in bronchiolar epithelium and alveolar cells. Prevention of this disease is discussed later.

Pertussis Syndrome

Although whooping cough is caused by *Bordetella pertussis*, adenoviruses may be isolated very frequently (39%) from patients infected with *B. pertussis*. The contribution of reactivated adenoviruses to the clinical features of pertussis is not known but serotype Ad5 may result in fatal adenovirus pneumonia complicating pertussis infection.

Infections of the Eye

Pharyngoconjunctival fever is a characteristic adenovirus syndrome. The acute follicular conjunctivitis which is part of this syndrome may also appear as a separate entity. After an incubation period of about 8 days, engorgement of both the bulbar and the palpebral conjunctiva is seen, with involvement of the cornea in 5–10% of patients. In addition, a characteristic preauricular lymphadenopathy is

Table 8.4 Clinical characteristics of 55 children with adenovirus gastroenteritis

Type of infection	Total no. of patients	Number (%) with indicated clinical finding								
		Diarrhoea	Mean duration (days)	Vomiting	Fever			Abdominal pain	> 5% dehydration	Respiratory symptoms
					37.5–38.9°C	< 39°C	Total			
Ad40	14	14 (100)	8.6	11 (79)	7 (50)	1 (7)	8 (57)	1 (7)	2 (14)	3 (21)
Ad41	19	18 (95)	12.2	15 (79)	7 (37)	1 (5)	8 (42)	7 (37)	3 (16)	4 (21)
Established adenovirus	14	14 (100)	6.2	7 (50)	5 (36)	9 (64)	14 (100)	5 (36)	2 (14)	11 (79)
Untyped adenovirus	8	8 (100)	4.5	6 (75)	2 (25)	3 (38)	5 (63)	4 (50)	1 (13)	2 (25)

Values in parentheses are percentages. Uhnoo *et al.* (1984).

usually present.

In Western countries the disease is frequently reported as a swimming pool conjunctivitis, and recently as a nosocomial infection. The most frequently encountered types are Ad3 (subgenus B) and Ad4 (subgenus E), but Ad1, 2 and 6 (subgenus C), 9, 10, 15, 17, 20, 22, 29 (subgenus D) and Ad16 of subgenus B have also been reported to cause conjunctivitis. In Asia there is a significantly higher prevalence of neutralizing antibodies to Ad3 and Ad4 than in Western countries and infection usually presents as conjunctivitis.

Epidemic keratoconjunctivitis is a distinctly different syndrome. Both Australian and German workers in the late nineteenth century described a syndrome characterized by an aggressive conjunctivitis, pain, photophobia and lymphadenopathy, followed by the development of a superficial punctate keratitis. In 1941 more than 10 000 cases occurred in the marine shipyards of Pearl Harbor. The disease then spread to the west coast of the USA and became known as 'the shipyard eye' (Jawetz, 1959). Ad8 was shown to be the cause of these infections.

Adenovirus keratoconjunctivitis affects males in Western countries or children in Asia and may last for 4–6 weeks. Corneal opacities can persist for several years. A typical slow clinical progression starts after an incubation period of 8 days, with foreign body sensation, prominent oedema of both conjunctivae and eyelids, and subconjunctival haemorrhage. Preauricular adenopathy is frequently found; pharyngitis may be seen. The keratitis first develops as a diffuse epithelial engorgement which

proceeds to punctate epithelial lesions. The conjunctivitis may resolve in about 2 weeks, but small round subepithelial opacities may persist in the cornea. Ad8, Ad19a and Ad37 are now the predominant causes of adenovirus-associated keratoconjunctivitis, although in Japan Ad4 is commonly associated with this condition.

Acute Haemorrhagic Cystitis

Acute dysuria with haematuria which occurs predominantly among 6– to 15-year-old boys has been described in Japan. Ad11 was the most frequently isolated adenovirus serotype. Similar observations have been reported from the USA but adenoviruses were incriminated less frequently as causative agents. It is important not to confuse this condition with glomerulonephritis. Acute haemorrhagic cystitis can be seen in renal transplant recipients.

Infections of the Gut

Diarrhoea

Adenoviruses have been associated with 4–15% of all hospitalized children with viral gastroenteritis. Gastroenteritis may be a sign of a systemic infection, such as those caused by Ad3 or Ad7. They may cause both respiratory symptoms and diarrhoea in a child with high fever. Ad31 is frequently isolated from stools of children with diarrhoea and may be of aetiological importance. However, the enteric

adenoviruses Ad40 and Ad41, which are fastidious and grow only in selected cell lines (see Chapter 4), have been demonstrated to account for two-thirds of cases of diarrhoea associated with adenoviruses.

A prospective study of 416 children in Uppsala yielded the information compiled in Table 8.4. The incubation period was 8–10 days, viral shedding 3–13 days, and the mean age of the patients 15 months (Ad40) and 28 months (Ad41). Ad40 and Ad41 were rarely associated with respiratory symptoms. Enteric adenoviruses cause diarrhoea, which may be less acute than typical rotavirus diarrhoea but symptoms persist for longer and are usually the reason for parents seeking medical attention. Mean duration of diarrhoea caused by established adenoviruses, Ad40 and Ad41, was 6.2, 8.6 and 12.2 days, respectively. At follow-up some children are intolerant to lactose-containing products 5–7 months after enteric adenovirus gastroenteritis. Occasionally there is also intolerance to gluten-containing food. It is apparent that the enteric adenoviruses are important causes of infantile diarrhoea, in Western countries second only to rotaviruses. In view of the protracted diarrhoeas it is important to analyse the frequency of lactose intolerance and coeliac disease as a consequence of infections with enteric adenoviruses. A fuller description of enteric adenoviruses and associated disease is given in Chapter 4.

Intussusception

Intussusception is a condition which appears as a consequence of a telescopic introduction (invagination) of a proximal into a distal intestinal segment. It has been suggested that adenitis in the intestinal wall or nearby mesenteric nodes is responsible for this condition. In addition, several reports have appeared indicating the presence of adenovirus inclusions in appendices which have been surgically removed in patients with the clinical features of appendicitis.

Infection of the CNS

Adenoviruses may be an infrequent cause of meningitis. Ad3 and Ad7 account for two-thirds of all adenovirus-associated cases of meningitis or meningoencephalitis. Subacute focal encephalitis is pre-

dominantly caused by the persistent members of subgenus A and C in immunocompromised hosts. Severe encephalitis caused by the members of subgenus B is occasionally seen in previously healthy children (Rautonen *et al.*, 1991).

Other Symptoms

Rubelliform or Stevens–Johnson-like exanthems have been described. Adenoviruses have also been associated with acute febrile polyarthritis and rhabdomyolysis.

Adenovirus Infection Associated with Immunocompromised Patients

Disseminated adenovirus disease with multiorgan involvement is seen in immunocompromised but rarely among previously healthy immunocompetent children (Munoz *et al.*, 1998). In paediatric patients and adult bone marrow transplant recipients, 31% and 13%, respectively, experienced adenovirus infections, a third of whom had a definite or probable adenovirus-associated disease. Ad35 was the most common serotype identified (Flomenberg *et al.*, 1994).

In primary immunodeficiencies the mean age of the patients with adenovirus infections was 4.4 years and the case fatality rate was 55%. Adenovirus of subgenus A, B and C were common but members of subgenus D were not reported. Hepatitis and pneumonia were the most frequently reported clinical features. Ad31 was the most commonly encountered virus and the fatality rate of 80% (Hierholzer, 1992).

Secondary immunodeficiency may occur in any patient having organ transplantation or in patients treated for malignant disease. The mean age of bone marrow transplant recipients with adenovirus infections was 15.6 years and they were susceptible to adenoviruses of subgroup A—Ad31, B—Ad11, 34 and 35 and C - Ad1, 2, 5, 5. The case fatality rate was 60%. In an account of 32 patients (mean age 2 years) with adenovirus infections following liver transplantation the case fatality rate was 53%, and 91% of the infections were caused by members of subgroup C Ad1, 2 and 5. All had liver disease.

In 33 renal transplant recipients (mean age 36

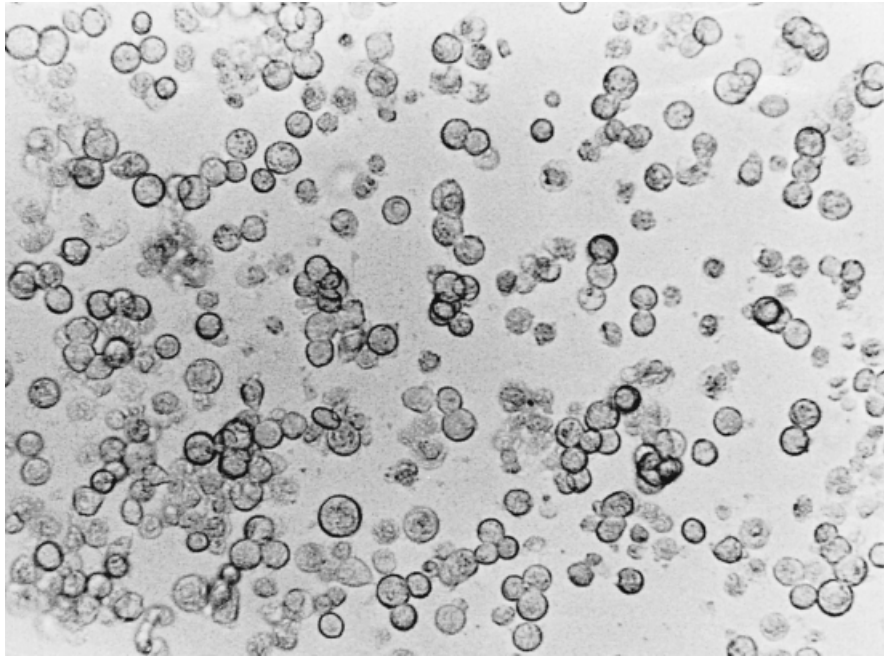

Figure 8.6 Cytopathic effect of A-549 cells 48 hours after infection with adenovirus 7b

years) the predominant symptom was acute haemorrhagic cystitis. Hepatitis was not seen and pneumonia was rare; 88% of the patients were infected by members of subgenus B (Ad7, Ad11, 34, 35). The prognosis is much better than for patients with other secondary immunodeficiency (Hierholzer, 1992).

Cancer patients on chemotherapy or being irradiated may be infected with adenoviruses of predominantly subgenus B and C, 53% of the infections may be fatal.

In patients with AIDS adenovirus infections were associated with pneumonia, encephalitis, hepatitis and colitis, but numerous other pathogens are usually present. Ad31 (subgenus A), Ad11, Ad35 (subgenus B) were isolated from urine and several types of subgenus C and D were isolated from stools (Hierholzer, 1992).

Extensive prospective studies are required to ascertain the role of different adenoviruses in primary and reactivated infections in the immunocompromised host in order to evaluate the need for appropriate means of immunoprophylaxis.

LABORATORY DIAGNOSIS

Virus Isolation

Collection of Specimens

Adenovirus may be isolated from conjunctival swabs, nasopharyngeal aspirates, pharyngeal swabs, leucocytes, urine and cerebrospinal fluid. The most reliable source, however, is stool specimens, particularly for members of subgenera A, D and F. Members of subgenera B, C and E can also be isolated from urine. Samples of stools are much better specimens for isolating adenoviruses than rectal swabs. Adenoviruses are stable and do not need refrigeration during transport. Swabs should be transported in tissue culture medium with fetal calf serum, bovine serum, albumin or gelatin. The medium should be supplemented with penicillin and streptomycin or gentamicin to prevent the growth of bacteria. Cultures from urine can be obtained by pelleting desquamated cells and resuspending the cells in a small volume of tissue culture medium. The adsorption of the virus inoculum to cells by rocking or rolling increases the efficiency of virus isolation. It is essential that the volume is kept to a minimum. After 1 hour the inoculum can be

removed if it is expected to be toxic, and maintenance medium added to the tube.

Cell Lines

Adenoviruses are highly host-cell specific. Isolation is consequently generally best achieved in human cells. However, primary to tertiary cynomolgus kidney cells display a wide permissiveness for human adenoviruses.

Primary human embryo kidney (HEK) cells and the established cell line A-549 cells derived from an oat cell carcinoma are permissive for adenovirus serotypes 1–39 and 42–49, however, enteric adenoviruses Ad40 and Ad41 cannot be isolated in these otherwise useful cells.

The continuous epithelial cell line HEp-2 derived from an epidermoid carcinoma, HeLa cells derived from a human cervical carcinoma and containing *Human papilloma virus type 18*, and KB cells derived from a carcinoma of the oral cavity are all useful for the isolation of established adenoviral serotypes, which will usually grow to high titres in these cells. However, as these epithelial cell lines cannot be maintained for longer than 10–14 days, a blind passage may be required for the successful isolation of Ad12, Ad18 and Ad31 of subgenus A and Ad8 of subgenus D, since they grow very slowly in these cell cultures.

Primary, secondary and even tertiary monkey kidney cells and 293 cells are excellent substrates for the isolation of enteric adenoviruses (Ad40 and Ad41). However, tertiary monkey kidney cells devoid of contaminating simian viruses are difficult to obtain. 293 cells are HEK cells immortalized by the E1A-E1B region of adenovirus 5 DNA. These cells apparently complement the host-dependent step in the replication of enteric adenoviruses and are particularly efficient for the isolation of Ad41 and certain strains of Ad40. Care should be taken to use high multiplicity of infection and treatment with trypsin prior to adsorption of enteric adenoviruses to 293 or monkey kidney cells. The inoculum is then adsorbed to the cell culture in a minimum volume for 60 minutes at 37°C in rolling tissue culture tubes. After the addition of maintenance medium with trypsin, the tubes should be rolled at 37°C.

Upon inspection of tissue cultures, adenovirus-specific cytopathic effect (CPE) will first be revealed at the margin of the cell culture. A characteristic rounding of cells with refractile intranuclear inclu-

sion bodies is noted (Figure 8.6). Adenoviruses induce glycolysis in continuous cell lines. Consequently, the lowered pH in the maintenance medium can be used to monitor the growth of adenoviruses.

Adenoviruses belonging to subgenera B and C produce large amounts of pentons. The vertex capsomer part of the penton has a propensity to interact with the host cell membrane and induce rounding of cells and subsequent cell detachment from the support within 2–4 hours after infection. This effect should not be mistaken for productive virus replication. Complete adenovirus replication requires 30–36 hours for the production of infectious virions. The release of infectious virus particles is slow. Consequently, a primary isolation of an unknown adenovirus serotype may require at least 10 days incubation.

Identification

An infectious agent causing rounding of cells in tissue culture can be classified as adenovirus by: (1) demonstrating the presence of DNA, i.e. inhibition of the growth of virus in the presence of FUDR; (2) the absence of an envelope by demonstrating that the infectivity is resistant to chloroform; and (3) the characteristic icosahedral morphology revealed by electron microscopy.

All mammalian adenoviruses, with the exception of several bovine serotypes, share common epitopes on hexons; consequently a number of serological techniques can be used to identify an isolate as an adenovirus. Complement fixation (CF), fluorescent antibody (FA), radioimmunoassay (RIA) or enzyme-linked immunosorbent assay (ELISA) tests have been used to demonstrate the presence of an adenovirus (Johansson *et al.*, 1980). In current practice the FA, ELISA or RIA assays can be used to identify an isolate as an adenovirus after isolation in tissue culture as well as directly on a specimen from the patient. When applied directly to respiratory specimens, FA lacks sensitivity, adenovirus only being detected in 30–60% of isolation positive specimens, depending on the quality of the specimen. FA requires the presence of epithelial cells containing intracellular viral antigen which may be absent in poorly taken or unsuitably transported specimens. Sensitivity is increased if FA is performed 48 hours postinoculation in cell culture, especially if the shell vial assay is performed, where

Table 8.5 Antigens associated with the major structural proteins

Protein	Corresponding polypeptide	Antigens		
		Designation	Specificity	Remarks
Hexon	II	α	Genus	Orientated toward the inside of the virion
		ϵ	Inter- and intrasubgenus Serotype	Available at the surface of the virion. Reacts with SN antibody
Penton base	III	β	Genus Inter- and intrasubgenus Serotype	Carries toxin activity
Fibre	IV	γ	Intersubgenus	Reacts with HI antibody shared between members of subgenera C and D
		δ	Intrasubgenus	Located at the proximal part of the fibre, not present in subgenus B

Modified from Petersson and Wadell (1985).

specimens are centrifuged gently on to the cell cultures prior to incubation (Espy *et al.*, 1987).

Generally, ELISA is less sensitive than FA when performed on respiratory specimens and is most suited for the detection of adenovirus in faecal material where antigen is not intracellular.

DNA restriction enzyme analyses and DNA hybridization techniques, in particular dot-blot assays, are also useful for identifying adenoviruses, especially those which are difficult to grow in tissue culture (Allard *et al.*, 1985). The use of intracellular viral DNA is recommended, as this enables analysis of numerous isolates. Efficient extraction methods have been elaborated by Shinagawa *et al.* (1983) and Fife *et al.* (1985). For diagnostic purposes confirmation of an adenovirus CPE in tissue culture and information on the subgenus of an isolate can be obtained by a general polymerase chain reaction (PCR) based on VA RNA (Kidd *et al.*, 1996). Further information on typing can be obtained by restriction fragment length polymorphism (RFLP) analysis after digestions of a hexon or a VA gene specific amplicon by restriction endonucleases (Allard *et al.*, 1994).

PCR is beginning to prove a useful tool for the identification of adenoviruses. Hexon-coded primers have been used in group-specific assays to detect adenovirus DNA in stool samples (Allard *et al.*, 1990, 1992) and in post-mortem specimens

(Turner *et al.*, 1993; Towbin *et al.*, 1994). Allard and coworkers have also developed an enteric adenovirus-specific PCR using primers located in the early region E1 gene. Sequencing of serotype specific regions can be used to type adenovirus isolates (Li *et al.*, 1999).

Typing of Isolates

An adenovirus serotype is defined by the capacity of a hyperimmune reference serum to neutralize its infectivity. A serotype is regarded as new if the ratio of homologous to heterologous neutralization titre is equal to or greater than 16. The dominating neutralizing epitopes are localized on the external portion of the hexons (Table 8.5). The hexon gene is localized between map units 50 and 62 of the adenovirus genome. Haemagglutination inhibition measures the interaction between IgG and type-specific epitopes on the tip of the fibre of the antenna-like projection at each vertex. The fibre gene is localized at map units 86–91. For most isolates there is concordance between the results of neutralization and haemagglutination inhibition. Haemagglutination-inhibition is a simple and rapid technique, provided that rat and monkey erythrocytes are available.

Typing of adenoviruses can also be achieved by ELISA assays using monoclonal antibodies provided that the epitopes are commonly expressed and correlate with the appearance of epitopes inducing neutralizing antibodies.

Solid-phase immune electron microscopy (SPIEM) is a versatile technique which can be used for serological typing of viruses in general (Svensson and von Bonsdorff, 1982).

One strain may carry neutralization and haemagglutination inhibition epitopes of two different serotypes provided they are members of the same subgenus. These strains are designated intermediate strains or haemagglutination variants.

erythrocytes in a complete pattern. The agglutination patterns of the other adenoviruses are less well discernible. A heterotypic rabbit antiadenovirus serum (antiadenovirus type 6 is frequently used) may be added in order to convert the excess of monovalent haemagglutinins (i.e. fibres and pentons) into divalent, complete haemagglutinins.

Serum neutralization assays are cumbersome but the most efficient means of detecting specific antibodies against each adenovirus serotype. All the above-mentioned techniques have been adapted to microtitre assays.

Serological Diagnosis

The worldwide distribution of adenoviruses can be assessed by analyses of prevalence of antibodies and/or frequency of isolation of adenovirus strains. Screening of adenovirus-specific antibodies gives reliable information on the prevalence of adenovirus infection in various populations. Mammalian adenoviruses share group-specific antigen epitopes which can be detected by CF or ELISA. CF for adenovirus-specific antibodies is ideally performed with a pool of antigen representing a serotype of each subgenus. If this is difficult to accomplish, representative serotypes of subgenus B (e.g. Ad7) and subgenus C (e.g. Ad2) should be used. Sonicated, clarified, infected cells provide a good source of antigen as a tenfold excess of structural proteins (predominantly hexons, pentons and fibres) carrying cross-reactive epitopes is produced. A fourfold or greater rise in CF antibody titre is a sign of current adenovirus infection.

CF tests have frequently been used to ascertain the prevalence of antibodies against adenoviruses. However, CF antibodies usually need to be boosted if they are to persist for longer periods. Furthermore, the CF assay is highly inefficient in detecting an immune response to adenoviruses in infants. The ELISA assay is therefore preferred.

Serotype-specific assays must be applied to obtain information on the response to each adenovirus serotype. Haemagglutination-inhibition assays using erythrocytes of monkeys (subgenus B) or rats (subgenera A, C, D, E or F.) can be used. Adenoviruses of subgenus B and D agglutinate

PREVENTION OF ADENOVIRUS INFECTIONS

Treatment of keratoconjunctivitis by adenoviruses during the acute phase with adenine arabinoside and iododeoxyuridine has been demonstrated to be unsuccessful. Adenovirus-associated respiratory disease is difficult to distinguish from respiratory disease from other causes. However, in the USA the clinical problem has been considered of such importance that vaccines have been developed. The early adenovirus vaccines were grown in primary monkey kidney cells which have been demonstrated to contain SV40 virus. SV40 virus can integrate into the E3 region of the adenovirus genome and this approach was therefore abandoned. A new principle for vaccination against respiratory viruses has been introduced in the form of live, oral, enteric-coated adenovirus vaccines. These strains were cultivated in human embryo fibroblasts. Initially there was some concern about the possibility of the appearance of additional adenovirus strains in place of the Ad4 and Ad7 which were eliminated by the vaccination introduced 1971. Adenovirus 21 did appear as a cause of outbreaks of respiratory disease. However, since 1976 Ad21 has been incorporated into the enteric-coated adenovirus vaccine and adenovirus-associated pneumonia has ceased to be a major problem in the US Army (Takafuji *et al.*, 1979). It has been estimated that at least 15 million recruits have been vaccinated. The vaccines are, however, not licensed for administration to children. For logistic reasons the production of the adenovirus vaccine was terminated in 1995, and by 1999 the supplies of the vaccine were depleted. Adenovirus infections among conscripts are now re-

emerging.

Ad14 has been reported to cause outbreaks of respiratory disease in the Netherlands but not the USA. Adenovirus 3 is known to cause infections among children. The herd immunity appears to be sufficient to prevent outbreaks among military recruits. Children living in crowded conditions may experience severe respiratory disease with Ad3 and Ad7. It is possible that vaccination should be considered in children less than 2 years old since this is the group principally at risk. However, vaccination of children with live vaccines cannot be contemplated until the virulence of different adenovirus genome types has been evaluated.

Adenoviruses are used as vectors for vaccination and gene therapy. They have been deleted in E1, E3 and E4 regions in order to provide for the transgene and ascertain that the vector will remain non-replicative. The advantages are that they can be produced in large amounts and transduce both replicating and nonreplicating cells. They are not integrating into the host chromosome and are non-oncogenic. The expression is usually transient. However, as vectors there are disadvantages because they do not interact with the host chromosome and expression is often transient, as they are highly immunogenic.

Intravenous injection of normal human immunoglobulin has been used to combat disseminated adenovirus disease (Munoz *et al.*, 1998). This form of prevention has not been sufficiently evaluated.

REFERENCES

- Adrian, T., Wadell, G., Hierholzer, J.C. *et al.* (1986) DNA restriction analysis of adenovirus prototypes 1 to 41. *Archives of Virology*, **91**, 277–290.
- Allard, A.K., Wadell, G., Evander, K.M. *et al.* (1985) Specific properties of two enteric adenovirus 41 clones, mapped within the E1A-region. *Journal of Virology*, **54**, 151–160.
- Allard, A., Girones, R., Juto, P. *et al.* (1990) Polymerase chain reaction for detection of adenoviruses in stool samples. *Journal of Clinical Microbiology*, **28**, 2659–2667.
- Allard, A., Albinsson, B. and Wadell, G. (1992) Detection of adenoviruses in stools from healthy persons and patients with diarrhoea by two-step polymerase chain reaction. *Journal of Medical Virology*, **37**, 149–157.
- Allard, A., Kajon, A. and Wadell, G. (1994) Simple procedure for discrimination and typing of enteric adenovirus after detection by polymerase chain reaction. *Journal of Medical Virology*, **44**, 250–257.
- Arnberg, N., Mei, Y-F. and Wadell, G. (1997) Fiber genes of adenoviruses with tropism for the eye and the genital tract. *Virology*, **277**, 239–244.
- Azar, R., Varsano, N., Milequir, F. *et al.* (1998) Molecular epidemiology of adenovirus type 7 in Israel: identification of two new genome types, Ad7k and Ad7d₂. *Journal of Medical Virology*, **54**, 291–299.
- Bailey, A. and Mautner, V. (1994) Phylogenetic relationships among adenovirus serotypes. *Virology*, **205**, 438–452.
- Bergelson, J.M., Cunningham, J.A., Droguett, G. *et al.* (1997) Isolation of a common receptor for coxsackie B viruses and adenoviruses 2 and 5. *Science*, **275**, 1320–1323.
- Carson, J.L., Collier, A.M. and Hu, S.-C.S. (1985) Acquired ciliary defects in nasal epithelium of children with acute viral upper respiratory infections. *New England Journal of Medicine*, **312**, 463–468.
- De Jong, J.C., Bijlsma, K., Wermenbol, A.G. *et al.* (1993) Detection, typing, and subtyping of enteric adenoviruses 40 and 41 from fecal samples and observation of changing incidences of infections with these types and subtypes. *Journal of Clinical Microbiology*, **31**, 1562–1569.
- Espy, M.J., Hierholzer, J.C. and Smith, T.F. (1987) The effect of centrifugation on the rapid detection of adenovirus in shell vials. *American Journal of Clinical Pathology*, **88**, 358–360.
- Fife, K.H., Ashley, R., Shields, A.F. *et al.* (1985) Comparison of neutralization and DNA restriction enzyme methods for typing clinical isolates of human adenovirus. *Journal of Clinical Microbiology*, **23**, 95–100.
- Flomenberg, P., Babbit, J., Drobyski, W.R. *et al.* (1994) Increasing incidence of adenovirus disease in bone marrow transplant recipients. *Journal of Infectious Diseases*, **169**, 775–781.
- Fox, J.P. and Hall, C.E. (1980) *Viruses in Families*. PSG, Littleton MD.
- Gerber, U., Webster, F., Weber, J. *et al.* (1996) The role of the adenovirus protease in virus entry into cells. *EMBO Journal*, **15**, 1766–1777.
- Green, M., Mackey, J.K., Wold, W.S.M. *et al.* (1979) Thirty-one human adenovirus subtypes (Ad1–Ad31) from five groups (A–E) based upon DNA genome homologies. *Virology*, **93**, 481–492.
- Hierholzer, J.C. (1992) Adenoviruses in the immunocompromized host. *Clinical Microbiology Reviews*, **5**, 262–274.
- Hierholzer, J.C., Stone, Y.O. and Broderson, J.R. (1991) Antigenic relationships among the 47 human adenoviruses determined in reference horse antisera. *Archives of Virology*, **121**, 179–197.
- Hilleman, M.R. and Werner, J.H. (1954) Recovery of new agents from patients with acute respiratory illness. *Proceedings of the Society for Experimental Biology and Medicine*, **85**, 183–188.
- Horwitz, M. (1985) Adenoviral diseases. In *Virology* (eds B.N. Fields *et al.*). Raven Press, New York.
- Itakura, S., Aoki, K., Sawada, H. *et al.* (1991) Changes in sub-genome types of adenovirus type 4 isolated from patients with ocular disease between 1985 and 1989 in Sapporo, Japan. *Journal of Clinical Microbiology*, **29**, 1740–1743.
- Jawetz, E. (1959) The story of shipyard eye. *BMJ*, **1**, 873–878.
- Johansson, M.E., Uhnoo, I., Kidd, A. *et al.* (1980) Direct identification of enteric adenovirus, a candidate new serotype associated with infantile gastroenteritis. *Journal of Clinical Microbiology*, **12**, 95–100.
- Kajon, A. and Wadell, G. (1996) Sequence analysis of the E3

- region and fiber gene of human adenovirus genome type 7h. *Virology*, **215**, 190–196.
- Kajon, A.E., Mistchenko, A.S., Videla, C. *et al.* (1996) Molecular epidemiology of adenovirus acute lower respiratory infections of children in the south cone of South America 1991–1994. *Journal of Medical Virology*, **48**, 151–156.
- Kidd, A.H., Garwicz, D. and Öberg, M. (1995) Human and simian adenoviruses: phylogenetic inferences from analysis of VA RNA. *Virology*, **207**, 32–45.
- Kidd, A.H., Jönsson, M., Garwicz, D. *et al.* (1996) Rapid sub-genus identification of human adenovirus isolates by a general PCR. *Journal of Clinical Microbiology*, **34**, 622–627.
- Li, Q.-G. and Wadell, G. (1988) Comparison of 17 genome types of adenovirus type 3 identified among strains recovered from six continents. *Journal of Clinical Microbiology*, **26**, 1009–1015.
- Li, Q.-G., Zhong, Q.-J., Liu, Y.-H. *et al.* (1996) Molecular epidemiology of adenovirus types 3 and 7 isolated from children with pneumonia in Beijing. *Journal of Medical Virology*, **49**, 170–177.
- Li, Q.-G., Henningson, A., Juto, P. *et al.* (1999) Use of restriction fragment analysis and sequencing of a serotype-specific region to type adenovirus isolates. *Journal of Clinical Microbiology*, **37**, 844–847.
- Munoz, F.M., Diedra, P.A. and Demmler, G.J. (1998) Disseminated adenovirus disease in immunocompromised and immunocompetent children. *Clinical Infectious Diseases*, **27**, 1194–1200.
- Pettersson, U. and Wadell, G. (1985) Antigenic structure of adenoviruses. In *Immunochemistry of Viruses: The Basis for Serodiagnosis and Vaccines* (eds M.H.V. van Regenmortel and A.R. Neurath). Elsevier, Amsterdam.
- Rautonen, J., Koskiniemi, M. and Vaheri, A. (1991) Prognostic factors in childhood acute encephalitis. *Pediatric Infectious Disease Journal*, **10**, 441–446.
- Rosen, L. (1960) Haemagglutination inhibition technique for typing adenovirus. *American Journal of Hygiene*, **71**, 120–128.
- Rowe, W.P., Huebner, R.J., Gillmore, L.K. *et al.* (1953) Isolation of a cytopathogenic agent from human adenoids undergoing spontaneous degeneration in tissue culture. *Proceedings of the Society for Experimental Biology and Medicine*, **84**, 570.
- Schmitz, H., Wigand, R. and Heinrich, W. (1983) Worldwide epidemiology of human adenovirus infections. *American Journal of Epidemiology*, **117**, 455–466.
- Schnurr, D. and Dondero, M.E. (1993) Two candidate adenovirus serotypes. *Intervirology*, **36**, 79–83.
- Shinagawa, M., Matsuda, A., Ishigama, T. *et al.* (1983) A rapid and simple method for preparation of adenovirus DNA from infected cells. *Microbiology and Immunology*, **27**, 817–822.
- Simila, S., Linna, O. and Lanning, P. (1981) Chronic lung damage caused by adenovirus type 7: a ten-year follow-up study. *Chest*, **80**, 127–131.
- Svensson, L. and von Bonsdorff, C.H. (1982) Solid-phase immune electron microscopy (SPIEM) by use of protein A and its application for characterization of selected adenovirus serotypes. *Journal of Medical Virology*, **10**, 243–253.
- Takafuji, E.T., Gaydos, J.C., Allen, R.G. *et al.* (1979) Simultaneous administration of live, enteric-coated adenovirus types 4, 7 and 21 vaccines: safety and immunogenicity. *Journal of Infectious Diseases*, **140**, 48–53.
- Tollefson, A.E., Ryerse, J.S., Scaria, A. *et al.* (1996) The E3 11.6 kDa adenovirus death protein (ADP) is required for efficient cell death: characterization of cells infected with adp mutants. *Virology*, **220**, 152–162.
- Towbin, J.A., Griffin, L.D., Martin, A.B. *et al.* (1994) Intrauterine adenoviral myocarditis presenting as non immune hydrops fetalis: diagnosis by polymerase chain reaction. *Pediatric Infectious Diseases Journal*, **13**, 144–150.
- Turner, P.C., Bailey, A.S., Cooper, R.J. *et al.* (1993) The polymerase chain reaction for detecting adenovirus DNA in formalin-fixed, paraffin-embedded tissue obtained post mortem. *Journal of Infection*, **27**, 43–46.
- Uhnnoo, J., Wadell, G., Svensson, L. *et al.* (1984) Importance of enteric adenoviruses 40 and 41 in acute gastroenteritis in infants and young children. *Journal of Clinical Microbiology*, **20**, 365–372.
- Varga, M.J., Weibull, C. and Everitt, E. (1991) Infectious entry pathway of adenovirus type 2. *Journal of Virology*, **65**, 6061–6070.
- Wadell, G. (1984) Molecular epidemiology of human adenoviruses. *Current Topics in Microbiology and Immunology*, **110**, 191–220.
- Wadell, G., Hammarskjöld, M.-L., Winberg, G. *et al.* (1980a) Genetic variability of adenoviruses. *Annals of the New York Academy of Sciences*, **354**, 16–42.
- Wadell, G., Varsanyi, T., Lord, A. *et al.* (1980b) Epidemic outbreaks of adenovirus 7 with special reference to the pathogenicity of adenovirus genome type 7b. *American Journal of Epidemiology*, **112**, 619–628.
- Wickham, T.J., Filardo, E.J., Cheresch, D.A. *et al.* (1994) Integrin $\alpha v \beta 5$ selectively promotes adenovirus mediated cell membrane permeabilization. *Journal of Cell Biology*, **127**, 257–264.
- Wigand, R. and Adrian, T. (1991) A rational system for classifying and denominating adenovirus genome types. *Research in Virology*, **142**, 47–56.

Rhinoviruses

Nikolaos G. Papadopoulos
and

Sebastian L. Johnston

University of Southampton, Southampton, UK

INTRODUCTION

Rhinoviruses (Figure 9.1) are the major cause of the common cold. Although the majority of infections produce only mild disease, their impact on overall morbidity and their economic cost worldwide are considerable. More recently, their role in acute exacerbations of asthma and other airway disease has been demonstrated, revealing a less benevolent nature than previously thought.

While the recorded history of the common cold is over 2000 years old (Hippocrates, *c.* 400 BC), rhinoviruses were first propagated in 1953 in tissue cultures whose supernatants were able to produce common cold symptoms in volunteers. The first rhinovirus was initially isolated from patients with colds and named in 1957, while 3 years later cytopathogenic viruses were recovered using human embryo kidney cell cultures (Tyrrell and Parsons, 1960). Other susceptible cell lines were subsequently discovered and used to identify additional serotypes and to study rhinoviral biology and role in disease. Recently, the genomes of several serotypes have been sequenced and three-dimensional structures have been revealed in atomic resolution. Molecular technologies are rapidly progressing in the development of novel diagnostic tools and will hopefully aid the so far unsuccessful search for an effective treatment.

TAXONOMY

Rhinoviruses are small RNA viruses belonging to the picornavirus (pico = small + RNA) family. *Picornaviridae* also include the enteroviruses, such as polio, coxsackie and echo viruses, cardioviruses such as the rodent *Encephalomyocarditis virus* and aphthoviruses or foot-and-mouth disease viruses. Rhinoviruses are more closely related to enteroviruses than the other genera. They are the most numerous of the *Picornaviridae*, with 100 serotypes identified and numbered by specific antisera in a collaborative programme supported by the World Health Organization (Hamparian *et al.*, 1987) (Table 9.1). New virus types are certainly emerging by a process of random mutation and immune selection (Patterson and Hamparian, 1997). Rhinoviruses are divided into major (90%) and minor (10%) groups, according to their cellular receptor usage (Uncapher *et al.*, 1991). An alternative categorization, dividing the viruses into groups A and B based on sensitivity to antiviral compounds and correlating with sequence similarities and pathogenicity, has also been proposed (Andries *et al.*, 1990).

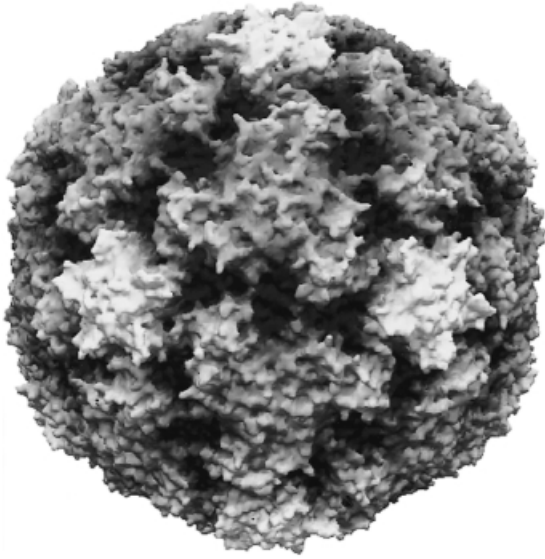

Figure 9.1 Three-dimensional computer enhanced electron micrograph of *Human rhinovirus 14*. The canyon can be seen surrounding the axis. (Courtesy of Dr J.Y. Sgro)

STRUCTURE

The Capsid

Rhinoviruses are among the simplest infectious agents. Their virion consists of a non-enveloped capsid surrounding a single-stranded positive-sense genomic RNA. In 1985, X-ray crystallography revealed the structure of *Human rhinovirus 14* (HRV14) and *Poliovirus 1* at atomic resolution (Hogle *et al.*, 1985; Rossmann *et al.*, 1985). These and subsequent studies showed considerable structural similarities amongst picornaviruses, such as prominent β -sheets forming a β -barrel, even though the sequence of each virus differs considerably from others in the group. The rhinoviral capsid is composed of 60 identical subunits arranged as 12 pentamers in an icosahedron (Figure 9.2). Each subunit consists of all four structural proteins of the virus, named VP1–VP4, with molecular masses of 32, 29, 26 and 7 kDa respectively. VP1, 2 and 3 are surface proteins interacting with antibody and corresponding to the part of the genome with the highest variability. VP4 is confined to the interior of the capsid and is closely associated with the viral RNA. The arrangement of these structural proteins can be seen in Figure 9.3. Around the fivefold symmetry

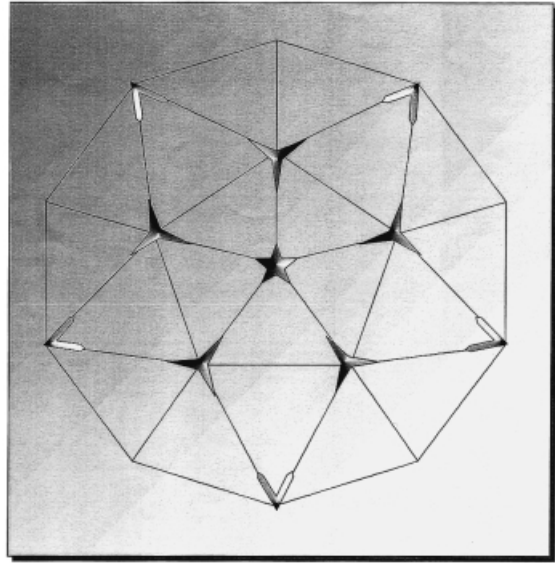

Figure 9.2 Rhinoviral icosahedral symmetry

axis of the capsid there is a 2.5 nm deep depression shaped by the five VP1 units, forming a ‘canyon’ (Figure 9.1). In most rhinoviruses, VP1 also contains a hydrophobic ‘pocket’ under the canyon, containing an incompletely characterized fatty-acid ‘pocket factor’. This pocket is thought to be involved in virus uncoating and is the major target of antiviral compounds (Hadfield *et al.*, 1997).

The characteristic conformation of the canyon, being physically unreachable by the immunoglobulin Fabs, was hypothesized to be the receptor binding site. Evidence in favour of this hypothesis has been produced (Colonno *et al.*, 1988), demonstrating that the amino acid sequences at the base of the canyon are very well conserved, while the edges of the canyon and the most external portions of the virus capsid are hypervariable and correspond to neutralizing immunogenic sites (Rossmann and Palmenberg, 1988).

Antigenicity

Four such neutralizing immunogenic (NIm) sites, localized in different areas of the capsid of RV14, along the edge of the canyon, were characterized by RNA sequencing of mutants that escaped neutralization by specific antisera (Sherry *et al.*, 1986). NIm-IA and NIm-IB on VP1 are positioned above the

Table 1 Rhinovirus serotypes

Serotype	Prototype strain	Serotype	Prototype strain
1A	Echo-28	51	F01-4081
1B	B632	52	F01-3772
2	HGP	53	F01-3928
3	FEB	54	F01-3774
4	16/60	55	WIS 315E
5	Norman	56	CH82
6	Thompson	57	CH47
7	68-CV 11	58	21-CV 20
8	MRH-CV 12	59	611-CV 35
9	211-CV 13	60	2268-CV 37
10	204-CV 14	61	6669-CV 39
11	1-CV 15	62	1963-CV 40
12	181-CV 6	63	6360-CV 40
13	353	64	6258-CV 44
14	1059	65	425-CV 47
15	1734	66	1983-CV 48
16	11757	67	1857-CV 51
17	33342	68	F02-2317-Wood
18	5986-CV 17	69	F02-2513-Mitchinson
19	6072-CV 18	70	F02-2547-Treganza
20	15-CV 19	71	SF365
21	47-CV 21	72	K2207
22	127-CV 22	73	107E
23	5124-CV 24	74	328A
24	5146-CV 25	75	328F
25	5426-CV 12	76	H00062
26	5660-CV 27	77	130-63
27	5870-CV 28	78	2030-65
28	6101-CV 29	79	101-1
29	5582-CV 30	80	277G
30	106F	81	483F2
31	140F	82	03647
32	363	83	Baylor 7
33	1200	84	432D
34	137-3	85	50-525-CV-54
35	164A	86	121564-Johnson
36	342H	87	F02-3607-Corn
37	151-1	88	CVD-01-0165-Dambrauskas
38	CH79	89	41467-Gallo
39	209	90	K2305
40	1794	91	JM1
41	56110	92	SF-1662
42	56822	93	SF-1492
43	58750	94	SF-1803
44	71560	95	SF-998
45	Baylor 1	96	SF-1426
46	Baylor 2	97	SF-1372
47	Baylor 3	98	SF-4006
48	1505	99	604
49	8213	100	K6579
50	A2 No. 58		

canyon, while NIm-II on VP2 and NIm-III on VP3, are positioned below. RV2 has a slightly different pattern; nevertheless, the antigenic sites are still located on the most protrusive regions of the virion.

High variability of these regions is implied by the large number of distinguishable serotypes and has been, to a certain extent, molecularly characterized (Horsnell *et al.*, 1995).

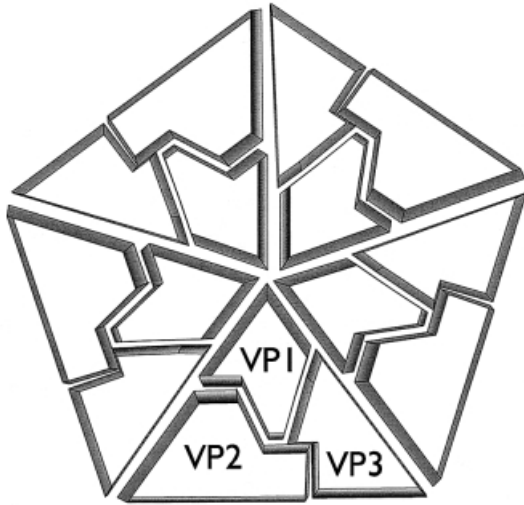

Figure 9.3 Arrangement of the three main structural rhinovirus proteins. The fourth structural protein, VP4, is confined in the interior, hence it is not visualized

Receptors

An important function of the viral capsid is to deliver the genomic material intact into a cell following attachment to a cell surface receptor. Initially, it has been shown that almost 90% of rhinoviruses (major group) bind to one receptor on HeLa cells, while the remaining (HRVs 1a, 1b, 2, 29, 30, 31, 44, 47, 49, 62) use another (Colonno *et al.*, 1986). The major group receptor was independently reported by three different groups in 1989 (Greve *et al.*, 1989; Staunton *et al.*, 1989; Tomassini *et al.*, 1989) as the intercellular adhesion molecule 1, (ICAM-1). ICAM-1 is a 95 kDa glycoprotein member of the immunoglobulin superfamily, physiologically acting as a receptor for the lymphocyte-function associated antigen-1 (LFA-1, CD11a/CD18) and Mac-1 (CD11b/cd18) found on leucocytes. It facilitates the interaction of lymphocytes with antigen-presenting cells as well as their migration to inflammatory sites (Montefort and Holgate, 1991). The binding sites of LFA-1 and major rhinoviruses on the ICAM molecule are distinct but significantly overlapping (Staunton *et al.*, 1990). Furthermore, cryoelectron microscopy proved that the rhinovirus binding site is positioned in the canyon, verifying the 'canyon hypothesis' (Rossman *et al.*, 1994). Binding of rhinoviruses to ICAM-1 blocks LFA-1–ICAM-1 interaction, possibly downregulating the local im-

mune response and upregulating the viral receptor itself (Papi *et al.*, 1998), while there is evidence that at the same time rhinovirus–ICAM-1 binding induces conformational changes promoting viral uncoating and cell entry (Casanovas and Springer, 1994).

The minor group receptors have been recently identified as the low density lipoprotein receptor (LDLR) and α_2 -macroglobulin receptor/LDLR-related protein (α_2 MR/LRP) (Hofer *et al.*, 1994). Limited information is currently available on their interactions with the virus.

Replication

Rhinoviral RNA has a molecular weight of approximately 2 MDa, consisting of some 7200 nucleotides (Duechler *et al.*, 1985). A 5' non-coding region of around 620 bases in length and a 3' non-coding region of 50 bases before a polyadenylated tail are characteristic of all currently sequenced serotypes (Figure 9.4). The long 5' untranslated region is highly conserved and contains several AUG codons upstream of that used to initiate translation. These sequences are within a complex structure, termed the internal ribosome entry site or IRES, which can bind ribosomal subunits directly, without the requirement for a free 5' end or a cap binding protein (Jackson *et al.*, 1990). The organization of the genome is shown in Figure 9.4. The structural proteins VP1–4 derive from the P1 region, while P2 and P3 code for the proteins required for virus replication. The non-structural proteins, seven in total, include two proteases with specific viral cleavage sites (2A, 3C), an RNA-dependent RNA-polymerase (3D) and a small protein Vpg (3B) which is covalently bound to the 5' end of the RNA and possibly acts as a primer for RNA synthesis (Rowlands, 1985). The remaining non-structural proteins (2B, 2C, 3A) are associated with RNA replication.

The single stranded, positive-sense RNA can act as messenger RNA and is infectious on its own. Similarly to the other picornaviruses, the genome is translated into a polyprotein from a single long open reading frame. This polyprotein is processed into the mature proteins by several cleavage steps performed by virus-specific proteases. With the polymerase, a negative-sense copy of the genome is produced, from which further positive strands are

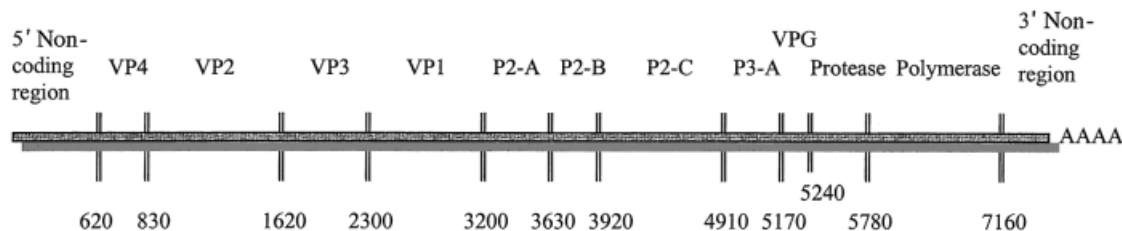

Figure 9.4 The rhinovirus genome

made by viral RNA polymerase, and these can act either as messenger RNA, being subsequently translated, or can be incorporated as genomic RNA in the progeny virus. Rhinoviruses are capable of completing numerous replicative cycles within 6–8 hours, with a yield of up to 100 000 viruses per cell (Belsham and Sonenberg, 1996).

ability to resist heat inactivation at 50–56°C, with some serotypes completely inactivated at lower temperatures and others quite resistant. Optimal culture temperature ranges from 33 to 35°C (Killington *et al.*, 1977).

PHYSICAL PROPERTIES

Rhinoviruses are small, with a diameter of 28–34 nm. Their total molecular weight is approx. 8–8.5 MDa and their buoyant density in caesium chloride is 1.38–1.42 g ml⁻¹ as fully infectious particles, or 1.29 g ml⁻¹ as empty capsids.

They are resistant to inactivation by organic solvents, including ether and chloroform, due to the absence of lipid envelope around the virion. They are also unaffected by 70–95% ethanol, 5% phenol and trichlorofluoroethane (Macnaughton, 1982); however, weak hypochlorite solution (common bleach) rapidly inactivates infectivity, provided that there is not a high concentration of organic matter present. Rhinoviruses are characteristically labile to extreme pH due to irreversible conformational changes, being inactivated at pH <5 as well as at pH 9–10. Acid sensitivity together with lipid solvent stability tests have been used for the identification of rhinoviruses. In addition, ultraviolet radiation is inactivating for rhinoviruses, while cationic substances, such as MgCl₂, are favourable for the replication of most serotypes, appearing to stabilize the virions, especially at high temperatures (Al-Nakib, 1995).

Viability steadily decreases at room temperature, while it remains stable for days at 4°C, months at –20°C and indefinitely at –70°C or lower. Rhinoviruses show considerable variation in their

INCUBATION AND TRANSMISSION

Infection with a rhinovirus can be initiated by small doses if the inoculum is effectively delivered to the nasopharynx. In experimental human transmission studies the frequency of virus shedding after inoculation varied by inoculum size and the titre of the subject's serum-specific antisero-type antibodies. All subjects with no neutralizing antibody could be infected with an inoculum of 10⁴ TCID₅₀ (Johnston and Tyrrell, 1995). The mode of person-to-person transmission has been debated; however, it is likely that both direct hand-to-surface-to-hand contact (Gwaltney and Hendley, 1978) and aerosol inhalation (Meschievitz *et al.*, 1984) are involved. Rhinoviruses are capable of surviving on surfaces for several hours under ambient conditions (Sattar *et al.*, 1993) and transfer of rhinovirus through hand touch can occur in only a few seconds, so that direct inoculation by rubbing the nares or eyes by infected hands can easily occur. Furthermore, the viral load in oral and pharyngeal secretions is considerably lower in comparison to nasal mucus (Johnston *et al.*, 1993a). On the other hand there is good experimental evidence (Dick *et al.*, 1987), as well as epidemiological evidence, favouring the predominance of the inhaled route (Johnston *et al.*, 1996).

The incubation period is 1–4 days, commonly 2–3 days. Generally viral shedding peaks 2–4 days after infection, lasting usually for 7–10 days, but it can persist for as long as 3 weeks. Natural transmission increases in relation to high virus titres in

nasal secretions, increased symptoms, time spent in contact and social factors such as crowding and hygiene. In families, the interval between the initial and secondary infections relates to the quantity and duration of shedding, ranging up to 10 days, with an average of 3 days (Foy *et al.*, 1988).

HOST RANGE

Rhinoviruses are in general extremely host specific. Human viruses have not been recovered from animals. Under experimental conditions, chimpanzees have been infected, developing a common cold-like disease, as well as gibbons, which do not exhibit symptoms. Other primates are less susceptible. One serotype has been adapted to replicate in the mouse lung with considerable difficulty; however, mice develop an immune response to parenterally administered rhinoviruses. Bovine and equine strains are not pathogenic to humans.

PATHOGENESIS

The nose is the main portal for rhinovirus entry. Alternatively, the eye and the mouth may serve as entry routes. Whether or not an infection can begin in the lower airways is not as yet clearly determined. Nasal epithelium is the primary site of infection. A series of upper airway biopsies suggested that rhinovirus infection may initiate in the nasopharynx, in the area of the adenoids (Winther *et al.*, 1986); however, rhinovirus replication occurs primarily in the nose, as inferred from comparative titrations of nasal, pharyngeal and oral secretions as well as of droplets from coughs and sneezes. Data favouring the possibility of rhinoviral replication in the lower airways are accumulating increasingly (Gern *et al.*, 1997a) but direct evidence is still missing. Viraemia is not detected in normal adults.

Rhinovirus infection does not produce extensive (or even detectable in some cases) cytopathology of the nasal mucous membrane; however, the extent correlates with the titre of recoverable virus. Mucosal oedema with sparse infiltration of inflammatory cells, mainly neutrophils, are the predominant histological changes. Nasal mucociliary clearance is reduced as a result of a reduced ciliary beat frequency and loss of ciliated epithelium (Wilson

et al., 1987).

Nasal secretions of infected individuals have increased plasma proteins such as albumin and IgG, as well as glandular proteins (lactoferrin, lysozyme and secretory IgA) (Igarashi *et al.*, 1993). These findings reflect both increased vascular permeability, usually mediated by vasoactive amines, and glandular secretion, commonly induced by cholinergic reflexes and neuropeptides. However, the detailed involvement of any such mediators remains to a great extent speculative (Figure 9.5). Kinins are generated in nasal secretions during natural and experimental colds, while their intranasal instillation causes sore throat (Naclerio *et al.*, 1988). Interleukin(IL)-1 is elevated in nasal secretions of experimentally infected volunteers (Proud *et al.*, 1994), as well as IL-6 (Zhu *et al.*, 1996) and IL-8 (Teran *et al.*, 1997). The presence of these proinflammatory cytokines is supportive of an immune rather than cytopathic basis of rhinoviral common cold symptomatology. The involvement of histamine is uncertain and conflicting results have been obtained from clinical trials of antihistamines. First-generation antihistamines could relieve sneezing and nasal discharge, but these compounds have H₁ blocking, anticholinergic and other central nervous system activities, in contrast to second-generation agents which are less effective in colds (Gwaltney, 1995). Elevated histamine levels were detected after experimental infection in allergic patients but not in normal subjects (Igarashi *et al.*, 1993).

As far as the nervous system is concerned, parasympathetic blockade is able to reduce some symptoms of rhinoviral colds (Gwaltney, 1995). Furthermore, unilateral inoculation and infection results in bilateral symptomatology, favouring a neural pathway activation (Winther *et al.*, 1986).

Vascular leakage and mucus secretion result in nasal blockage and stimulation of the sneeze and cough reflexes, resulting in the well-known common cold symptomatology.

Mucosal oedema resulting from vascular leakage, venous sinusoidal engorgement and mucosal inflammatory cell infiltration is a prominent feature, and may lead to complications such as otitis and sinusitis. Indeed, computerized tomography (CT) scans obtained during and after acute rhinoviral infection have clearly demonstrated that paranasal sinus occlusion is a common event in rhinovirus colds (Gwaltney *et al.*, 1994).

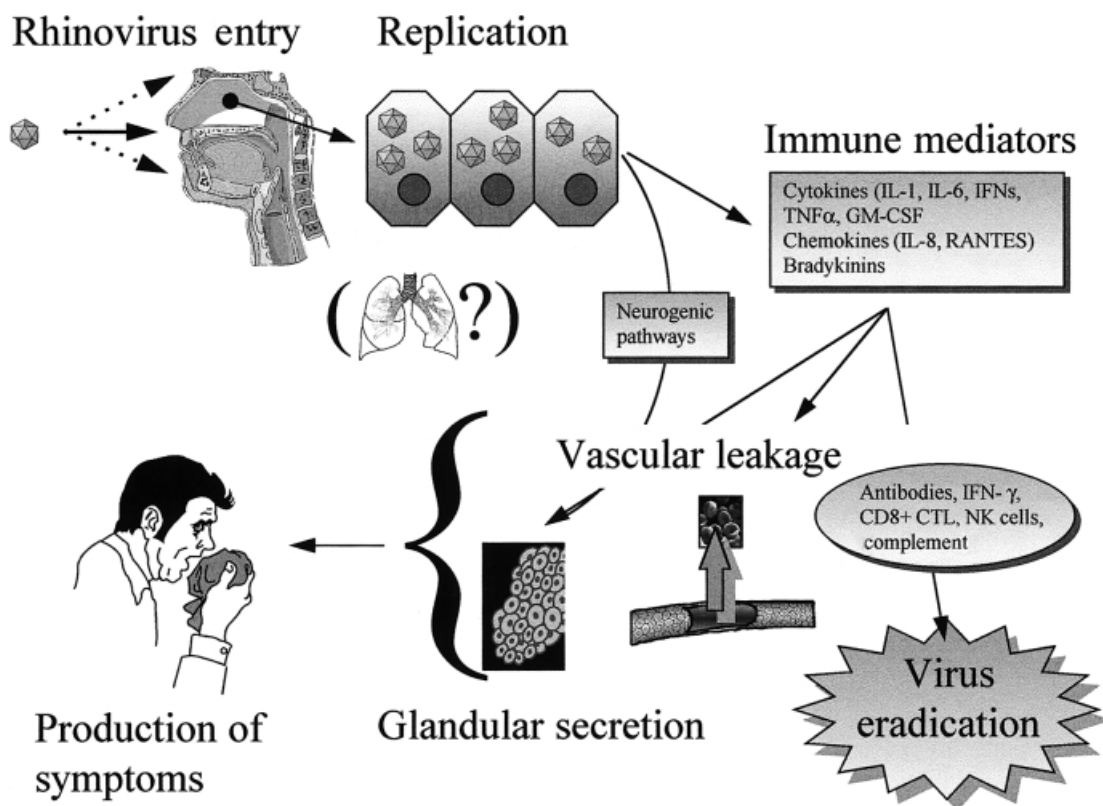

Figure 9.5 Pathogenetic mechanisms of rhinoviral infection. Rhinovirus entry and replication in the nasopharynx induces immune mediators and neurogenic pathways. Viruses are eradicated, but the concurrent vascular leakage and glandular secretion result in the well-known symptomatology

The mechanisms of exacerbations of asthma induced by viral infections in susceptible individuals is another issue in rhinovirus pathophysiology currently under investigation. Rhinovirus infection seems to potentiate allergic responses (Calhoun *et al.*, 1994), however, the precise mechanisms have yet to be determined. Inflammatory mediators such as kinins, and proinflammatory cytokines induced by rhinovirus infection (IL-1, IL-6, IL-8, GM-CSF, IFN- α and IFN- γ), altered cell-mediated immunity, virus-specific IgE and other mechanisms have been proposed, but the relative importance of each of these currently remains unclear (Johnston, 1995).

IMMUNITY

Both cellular and humoral immunity are activated in response to rhinovirus infection. Virus-specific

IgG and IgA serum antibodies remain low for the first week after inoculation and subsequently begin to increase, to reach their peak approximately a month later. IgG antibodies stay at high levels for at least a year, while IgA declines slowly but remains detectable during the same period. Nasal IgA is also produced, becoming detectable 2 weeks after inoculation, reaching its peak 1 week later and slowly declining to its original levels by 1 year (Barclay *et al.*, 1989). The late rise in antibody titres indicates that humoral immunity is not essential for recovery from viral illness. On the other hand, existing antibodies, especially in high titres, may protect against reinfection with the same serotype (Barclay *et al.*, 1989). Possible ways for antibody-mediated virus inactivation include virus aggregation, activation of the complement cascade, prevention of binding to receptor and inhibition of uncoating (Rowlands, 1995).

An important role in virus eradication has been

attributed to cellular immunity; however, the mechanisms involved are not yet understood in detail. In contrast to the high specificity of humoral immunity, rhinovirus-specific T cells can recognize both serotype-restricted and shared viral epitopes (Gern *et al.*, 1997b). Peripheral blood lymphocyte counts are decreased during infection, followed by recovery or even leucocytosis (Skoner *et al.*, 1993). An increased production of IL-2 and IFN- γ after mitogen stimulation, as well as increased natural killer cytotoxicity, has been found in peripheral blood mononuclear cells after experimental rhinovirus infection (Hsia *et al.*, 1990). Lymphocytes can be activated both specifically and non-specifically through a monocyte-dependent mechanism (Gern *et al.*, 1996a). Rhinoviruses enter but do not replicate inside monocytes and airway macrophages, indicating a potentially direct effect of these cells in antiviral immunity (Gern *et al.*, 1996b). Locally produced soluble factors by activated immune cells, such as interferons or tumour necrosis factors, have potent antiviral activities (Wong and Goddel, 1986).

EPIDEMIOLOGY

The common cold is probably the illness most frequently afflicting humans, and is certainly the most common cause for primary care consultations and absenteeism from work or school. The average number of yearly infections in adults is estimated to be between two and five, while this number increases up to 12 in children. A simple calculation would reveal that a normal individual spends between 1 and 2 years of life suffering from colds!

Rhinoviruses cause about 35–60% of common colds. Interestingly, in contrast to popular belief, early studies were unable to demonstrate any increase in susceptibility to rhinoviral infections after exposure to cold temperatures (Douglas *et al.*, 1968); however, several other epidemiological factors are involved. Age is certainly important. Infections increase significantly from the second year of life and throughout school age, decreasing subsequently, probably due to neutralizing antibodies induced by previous exposures (Monto, 1995). Increased morbidity and complications reappear in the elderly (Nicholson *et al.*, 1997). Apart from the age-related susceptibility to the virus, socio-economic factors such as nutrition and population

density, but most importantly family structure, strongly influence the incidence of rhinovirus infections. An infection is usually introduced by a child to other siblings and parents at home. Mothers are more susceptible than fathers, possibly because of increased exposure. School and day care transmission is also very high, due to overcrowding, low immunity and children's unhygienic habits (Levandoski, 1992).

A seasonal pattern has been documented in temperate climates, with two peaks occurring—one in autumn, coinciding with the opening of schools, and another one in late spring. During winter the occurrence of rhinovirus infections is reduced (Fox *et al.*, 1975), although more recent studies have suggested that school attendance is the major factor in determining seasonal patterns, and that infections occur throughout the winter months, peaking in the first 2–3 weeks after children return to school (Johnston *et al.*, 1996).

All populations are affected. The prevalent serotypes vary from year to year. It is possible that a small number of serotypes may cause most of the illnesses (Monto *et al.*, 1987); however, virus isolation and serotyping techniques are still cumbersome and inadequate for detailed evaluation.

There is a well-documented epidemiological relationship between psychological stress and the susceptibility to rhinovirus infection (Cohen, 1995), the mechanisms of which are still speculative.

CLINICAL FEATURES

The symptoms most easily described are those that everybody has experienced (Hippocrates, *c.* 400 BC). Rhinoviruses produce the symptoms of the common cold, including rhinorrhoea, sneezing, nasal obstruction, sore throat and cough. General malaise and headache may occur, while fever is less common. The course of the disease correlates with virus titres. Symptoms appear after a 24–48 hour incubation period, reach their peak 2–3 days later and last for 5–7 days in total, persisting occasionally for as long as 2–4 weeks. Symptom severity is highly variable; on many occasions the disease may be hardly noticed.

On the other hand, rhinovirus infections may cause significant morbidity in specific patient groups. Infants with bronchopulmonary dysplasia

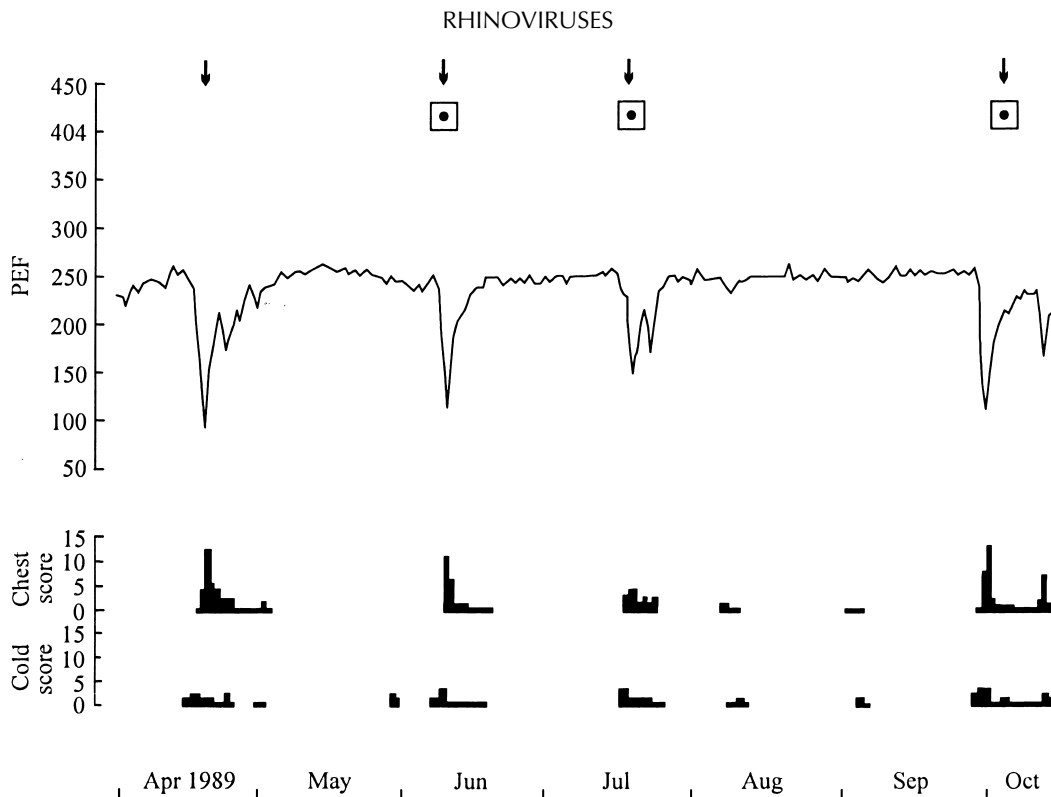

Figure 9.6 Chart of diary card recordings from a 10-year-old child with intermittent wheeze during community acquired rhinovirus infections (indicated by arrows; major group rhinovirus infections indicated by boxes). Episodes of falls in peak expiratory flow (PEF) associated with severe lower respiratory symptoms (wheeze and cough, chest score) and upper respiratory symptoms (cold score) are clearly seen

may develop serious respiratory illness, necessitating admission to an intensive care unit and occasionally mechanical ventilation (Chikedel *et al.*, 1997). Pulmonary function abnormalities, disease progression and secondary bacterial infections can result in children with cystic fibrosis (Collinson *et al.*, 1996). Senior persons, especially residents of nursing homes, are also prone to severe disease that can exceptionally prove fatal (Wald *et al.*, 1995). Furthermore, atopic individuals seem to be predisposed to more severe rhinoviral colds than normal subjects (Bardin *et al.*, 1994).

Complications

Acute sinusitis and acute otitis media have been associated with rhinoviral infections. As previously mentioned, sinus involvement is detected by CT in a considerable percentage of rhinovirus infections, while there is evidence suggesting a causal role of

the virus in as many as 50% of episodes of community-acquired sinusitis (Pitkaranta *et al.*, 1997). Moreover, rhinoviruses account for approximately 40% of viral acute otitis media (Buchman *et al.*, 1994). In both instances, the viruses may also facilitate or contribute to concurrent bacterial infections.

The role of rhinoviral infection in exacerbations of asthma has been well documented in recent studies. Upper respiratory tract infections are associated with up to 80% of asthma episodes in schoolchildren, with rhinovirus being the most commonly isolated agent (Johnston *et al.*, 1995) (Figure 9.6). In adults, the figures are smaller (Beasley *et al.*, 1988) although studies employing methodology as sensitive as that used in children have yet to be reported. Time trend analysis suggests that viral infections are indeed important in exacerbations in adults as well as children (Johnston *et al.*, 1996).

Rhinoviruses are also implicated in acute and chronic bronchitis but this subject has yet to be adequately studied.

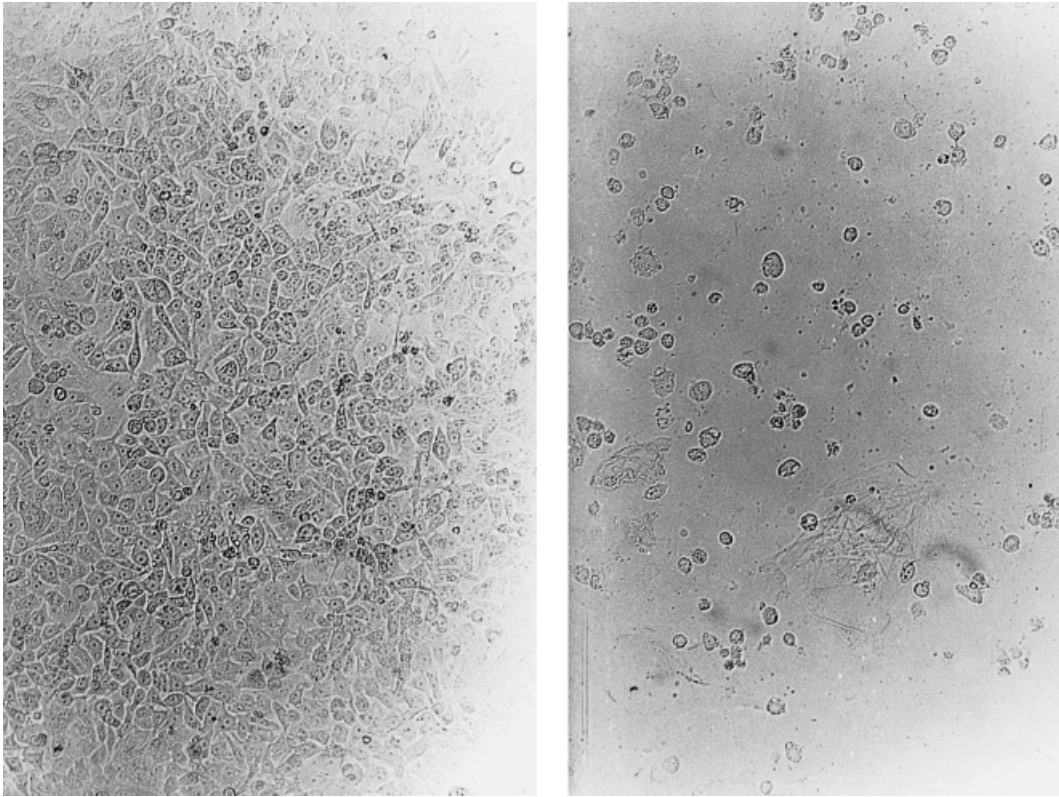

Figure 9.7 Rhinovirus infected Ohio-HeLa cell culture with the characteristic cytopathic effect (right), in comparison to control cells (left)

DIAGNOSIS

Virus cultures, serological tests and more recently nucleic acid detection have been used in the detection of rhinoviruses for diagnostic and research purposes. The former two are cumbersome, time consuming and relatively insensitive, so that their diagnostic value is rather limited in a clinical setting. Nucleic acid techniques, mainly the polymerase chain reaction (PCR), can potentially overcome these difficulties, and following their standardization may eventually become the methods of choice for viral detection.

Virus Isolation

The optimal specimen for virus isolation is a nasal washing or a nasal aspirate. Throat or nasal swabs are used as an alternative in the field, or in children

in whom nasal washings are difficult to obtain. Samples should be transported to the laboratory in virus transport medium as soon as possible and put immediately into culture or stored frozen at -70°C . Rhinoviruses replicate in several human embryonic and monkey tissues but they replicate best in human fetal lung fibroblasts (WI38, MRC5) and strains of HeLa cells. Samples are inoculated in cell cultures in tubes and are incubated in a roller drum at 33°C . They are then monitored under low-field magnification daily for the development of a cytopathic effect (CPE). Rhinoviral CPE is characterized by shrinkage and rounding of cells, cellular destruction and detachment of the cell layer (Figure 9.7). It can be noticed as early as 24 hours after inoculation, while the majority of positive samples develop CPE within 8 days. A second passage after this time is usually performed to identify less potent strains (Johnston and Tyrrell, 1995). Confirmation of rhinoviral identity can be performed by acid stability testing, and of individual serotypes by neutralization tests using specific antisero type antisera.

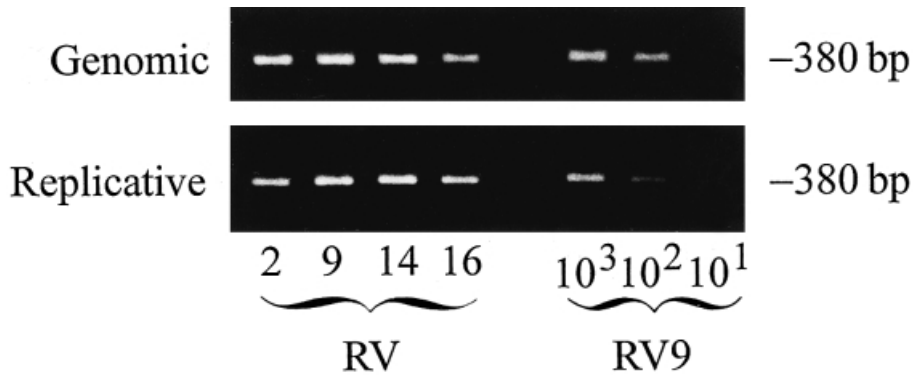

Figure 9.8 Agarose gel electrophoresis of PCR products reveals a band at 380 bp. Both genomic and replicative strands (using OL27 primer and OL26 primer on the reverse transcriptase, respectively) are shown for rhinoviruses 2, 9, 14 and 16 (left half). Dilutions of RV9 can be detected up to 10^{-2}

Serology

Serological methods can be used for the detection of antiviral antibodies. Neutralization tests can be used for antibody detection and quantification once the serotype is known, as in the case of experimental studies with volunteers inoculated with a known serotype, or with a virus isolated from the same patient. Preinfection and postinfection serum titres are compared. Unfortunately, owing to the large number of serotypes (> 100), these tests are only of limited practical value and are not used in routine clinical diagnosis.

Hemagglutination inhibition tests are possible with a subset of rhinoviruses that agglutinate red blood cells. Their results are comparable to those of the neutralization assays, but they are not widely used as they require large amount of virus and can be applied only to a subset of serotypes.

ELISAs are faster and much easier to perform, offer better sensitivity and can be readily adapted to measure different antibody isotypes both in serum and nasal secretions (Barclay *et al.*, 1989); however, as with the other serological assays, ELISA is diagnostically useful only when the rhinovirus serotype is already known.

Nucleic Acid Detection

Initial attempts to diagnose rhinovirus infection using cDNA probes from the 5' and 3' non-coding

regions were disappointing because of the major sequence variability in these regions. Oligonucleotide probes complementary to two conserved regions within the 5' non-coding region permitted rhinovirus identification in nasal washings from experimentally induced colds (Bruce *et al.*, 1989); unfortunately high levels of non-specific binding are observed in asymptomatic subjects. Different approaches based on the PCR have been investigated. A set of primers that could distinguish rhinoviruses from the closely related enteroviruses, based on differences on the length of the 5' non-coding region, has been used, with results equivalent to virus culture (Olive *et al.*, 1990). In another study, these and other sets of primers were compared in PCRs combined with probe hybridization assays using radioactive internal probes. The best assay was considerably more sensitive than virus cultures, but only when a pair of primers that could not differentiate between rhinoviruses and enteroviruses (OL26–OL27) was used (Johnston *et al.*, 1993b) (Figure 9.8). Primer sets that can differentiate rhinoviruses from enteroviruses have been studied (Mori and Clewley, 1994) and high sensitivity has been achieved in clinical studies (Chauhan and Johnston, 1998). Molecular methods for infectious agent identification are steadily becoming more widely applied in regard to a vast array of microorganisms. The optimization of these techniques will be particularly useful in the case of rhinoviruses, where a fast and reliable clinical diagnostic assay is awaited.

Table 9.2 Efforts towards an antirhinoviral therapy

Therapy	Effects
<i>General</i>	
Ascorbic acid, zinc gluconate, inhalation of hot air, non-steroidal anti-inflammatory	Questionable benefit
<i>Anti-inflammatory</i>	
Corticosteroids (oral or inhaled)	Effective in reducing symptoms only in high doses, for a short period and with a rebound effect
Cromolyns	Reduce symptoms and duration of disease. Unknown mechanisms
Antihistamines	Little benefit. Some improvement in sneezing and rhinorrhoea
Anticholinergic nasal sprays	Reduce sneezing and rhinorrhoea
<i>Antiviral</i>	
Interferon α	Able to prevent symptoms, but expensive and with significant side-effects
<i>Combination therapies</i>	
	Combination of interferon α , ipratropium and naproxen was effective in one clinical trial
<i>Experimental therapies</i>	
Antirhinoviral compounds	
	Enviroxime, WIN compounds, chalcones, pyridazinamines and others; prevent viral uncoating. Some are currently under clinical trials. Problems with pharmacokinetics
Soluble ICAM-1	Inhibits viral attachment of major type viruses to their receptor. Promising in initial clinical trials
Antisense oligonucleotides, 3C antiproteinasases, DNA vaccines	Potential routes of future intervention

PREVENTION AND TREATMENT

Intensive efforts during the last 40–50 years for the development of treatment or prevention strategies against the rhinoviral common colds have so far been without encouraging results. The approaches that have been investigated include non-specific and empiric therapies, antiviral and antimediator drug treatments, and vaccines.

The major obstacle for vaccine development is

the large number of serotypes which do not produce heterotypic humoral immunity. Initial attempts have achieved protection against a specific serotype in volunteers inoculated with inactivated viruses. A decavalent vaccine was also tested in humans, resulting in variable responses to the included serotypes and insufficient heterotypic immunity (Hamory *et al.*, 1975). The protective duration of any responses was also undefined. More recently, the design of peptide vaccines, especially against T cell epitopes which seem to be more conserved, is promising but still at an early stage (Francis *et al.*, 1989).

Among the pharmacological antiviral agents, IFN- α has been the first and most widely investigated. Interferon is effective if given intranasally before or shortly after exposure to the virus, both in experimental infections in volunteers and in family outbreaks (Douglas *et al.*, 1986); however, its high cost and local bleeding and discharge after long term prophylactic schemes have been major drawbacks for its clinical use.

A large number of compounds able to inhibit rhinoviral infection by preventing virus uncoating and/or cell entry have been investigated (Table 9.2). Unfortunately, to date no effective drug has emerged from this research, owing to problems in potency, delivery and toxicity of the compounds and the emergence of resistant viral strains (Arruda and Hayden, 1996).

Since much of the symptomatology of the common cold is produced through inflammatory mediators, drugs antagonizing these mediators have been tested: little benefit was demonstrated by antihistamine treatment; a bradykinin antagonist showed negative results; while anticholinergic sprays were able to reduce rhinorrhea and sneezing (Johnston, 1997). Corticosteroids were found to have a marginal effect on symptoms, but a rebound appeared when treatment was stopped; moreover, they have been associated with increases in viral titres.

The inadequacy of specific therapies and the fact that the problem is so common have supported the emergence of non-specific treatments. These include the use of ascorbic acid, zinc gluconate and the inhalation of humidified hot air. For all these remedies the mechanisms are speculative and the evidence frequently contradictory. More promising results have been obtained by the use of cromolyns, antiallergic and anti-inflammatory drugs acting on

mast cells, eosinophils and epithelial cells, which were able to reduce cold symptoms and shorten the duration of the illness (Aberg *et al.*, 1996).

A combination approach was also proposed (Gwaltney, 1992), involving the administration of antiviral (IFN- α), anticholinergic (ipratropium) and anti-inflammatory (naproxen) drugs: a significant therapeutic result was achieved, together with a decrease in viral shedding.

Advances in molecular biological techniques have renewed interest in novel therapeutic approaches. New antiviral compounds are synthesized by computer-aided design, such as drugs that can fit in the hydrophobic pocket of VP1, stabilizing the capsid proteins and preventing uncoating, or rhinovirus protease inhibitors. Another possibility includes the use of antisense oligonucleotides which anneal *in vitro* to viral RNA and are subsequently degraded by RNases (Johnston, 1997).

Most interestingly, a soluble form of the major rhinoviral receptor ICAM-1 can inhibit viral entry and inactivate the virus in most experimental settings; furthermore, soluble ICAM-1 was able to prevent rhinovirus infection in chimpanzees (Huguenel *et al.*, 1997) and initial human trials have promising results.

REFERENCES

- Aberg, N., Aberg, B. and Alestig, K. (1996) The effect of inhaled and intranasal sodium cromoglycate on symptoms of upper respiratory tract infections. *Clinical and Experimental Allergy*, **26**, 1045–1050.
- Al-Nakib, W. (1995) Rhinoviruses. In *Principles and Practice of Clinical Virology*, 3rd edn (eds A.J. Zuckerman, J.E. Banatvala and J.R. Pattison) pp 309–324. Wiley, Chichester.
- Andries, K., Dewindt, B., Snoels, J. *et al.* (1990) Two groups of rhinoviruses revealed by a panel of antiviral compounds present sequence divergence and differential pathogenicity. *Journal of Virology*, **64**, 1117–1123.
- Arruda, E. and Hayden, F.G. (1996) Update on therapy of influenza and rhinovirus infections. *Advances in Experimental Medicine and Biology*, **394**, 175–187.
- Barclay, W.S., Al-Nakib, W., Higgins, P.G. *et al.* (1989) The time course of the humoral immune response to rhinovirus infection. *Epidemiology of Infection*, **103**, 659–669.
- Bardin, P.G., Fraenkel, D.J., Sanderson, G. *et al.* (1994) Amplified rhinovirus colds in atopic subjects. *Clinical Experimental Allergy*, **24**, 457–464.
- Beasley, R., Coleman, E.D., Hermon, Y. *et al.* (1988) Viral respiratory tract infection and exacerbations of asthma in adult patients. *Thorax*, **43**, 679–683.
- Belsham, G.J. and Sonenberg, N. (1996) RNA-protein interactions in regulation of picornavirus RNA translation. *Microbiological Reviews*, **60**, 499–511.
- Bruce, C.B., Al-Nakib, W., Almond, J.W. *et al.* (1989) Use of synthetic oligonucleotide probes to detect rhinovirus RNA. *Archives of Virology*, **107**, 179–187.
- Buchman, C.A., Doyle, W.J., Skoner, D. *et al.* (1994) Otolgic manifestations of experimental rhinovirus infection. *Laryngoscope*, **104**, 1295–1299.
- Calhoun, W.J., Dick, E.C., Schwartz, L.B. *et al.* (1994) A common cold virus, rhinovirus 16, potentiates airway inflammation after segmental antigen bronchoprovocation in allergic subjects. *Journal of Clinical Investigation*, **94**, 2200–2208.
- Casanovas, J.M. and Springer, T.A. (1994) Pathway of rhinovirus disruption by soluble intercellular adhesion molecule-1 (ICAM-1): an intermediate in which ICAM-1 is bound and RNA is released. *Journal of Virology*, **68**, 5882–5889.
- Chauhan, A.J. and Johnston, S.L. (1999) Advances in the diagnosis of respiratory virus infections. In *Asthma and Respiratory Viruses* (ed. D.P. Skoner), in press. Marcel Dekker, New York.
- Chikedel, A.S., Rosen, C.L. and Bazzi, A.R. (1997) Rhinovirus infection associated with serious lower respiratory illness in patients with bronchopulmonary dysplasia. *Pediatric Infectious Diseases*, **16**, 43–47.
- Cohen, S. (1995) Psychological stress and susceptibility to upper respiratory infections. *American Journal of Respiratory and Critical Care Medicine*, **152**, S53–58.
- Collinson, J., Nicholson, K.G., Cancio, E. *et al.* (1996) Effects of upper respiratory tract infections in patients with cystic fibrosis. *Thorax*, **51**, 1115–1122.
- Colonna, R.J., Callahan, P.L., Long, W.J. *et al.* (1986) Isolation of a monoclonal antibody that blocks attachment of the major group of human rhinoviruses. *Journal of Virology*, **57**, 7–12.
- Colonna, R.J., Condra, J.H., Mituzani, P.L. *et al.* (1988). Evidence for the direct involvement of the rhinovirus canyon in receptor binding. *Proceedings of the National Academy of Sciences of the USA*, **85**, 5449–5453.
- Dick, E.C., Jennings, L.C., Mink, K.A. *et al.* (1987) Aerosol transmission of rhinovirus colds. *Journal of Infectious Diseases*, **156**, 442–448.
- Douglas, R.G. Jr, Lindgren, K.M. and Couch, R.B. (1968) Exposure to cold environment and rhinovirus common cold. Failure to demonstrate effect. *New England Journal of Medicine*, **279**, 742–746.
- Douglas, R.M., Moore, B.W., Miles, H.B. *et al.* (1986) Prophylactic efficacy of intranasal α_2 -interferon against rhinovirus infections in the family setting. *New England Journal of Medicine*, **314**, 65–70.
- Duechler, M., Skern, T., Sommergruber, W. *et al.* (1985) Evolutionary relationships within the human rhinovirus genus: comparison of serotypes 89, 2, and 14. *Proceedings of the National Academy of Sciences of the USA*, **84**, 2605–2609.
- Fox, J.P., Cooney, M.K. and Hall, C.E. (1975) The Seattle virus watch. V. Epidemiologic observations of rhinovirus infections, 1965–1970, in families with young children. *American Journal of Epidemiology*, **101**, 122–143.
- Foy, H.M., Cooney, M.K., Hall, C. *et al.* (1988) Case-to-case intervals of rhinovirus and influenza virus infections in households. *Journal of Infectious Diseases*, **157**, 180–182.
- Francis, M.J., Hastings, G.Z., Campbell, R.O. *et al.* (1989) T cell help for B cell antibody production to rhinovirus peptides. In *Vaccines 89*, pp 437–444. Cold Spring Harbor Press, Spring Harbor NY.

- Gern, J.E., Vrtis, R., Kelly, E.A.B. *et al.* (1996a) Rhinovirus produces nonspecific activation of lymphocytes through a monocyte-dependent mechanism. *Journal of Immunology*, **157**, 1605–1612.
- Gern, J.E., Dick, E.C., Lee, W.M. *et al.* (1996b) Rhinovirus enters but does not replicate inside monocytes and airway macrophages. *Journal of Immunology*, **156**, 621–627.
- Gern, J.E., Galagan, D.M., Jarjour, N.N. *et al.* (1997a) Detection of rhinovirus RNA in lower airways during experimentally induced infection. *American Journal of Respiratory and Critical Care Medicine*, **155**, 1159–1161.
- Gern, J.E., Dick, E.C., Kelly, E.A.B. *et al.* (1997b) Rhinovirus-specific T-cells recognise both shared and serotype-restricted viral epitopes. *Journal of Infectious Diseases*, **175**, 1108–1114.
- Greve, J.M., Davis, G., Meyer, A.M. *et al.* (1989) The major human rhinovirus receptor is ICAM-1. *Cell*, **56**, 839–847.
- Gwaltney, J.M. Jr (1992) Combined antiviral and antimediator treatment of rhinovirus colds. *Journal of Infectious Diseases*, **166**, 776–782.
- Gwaltney, J.M. Jr (1995) Rhinovirus infection of the normal human airway. *American Journal of Respiratory and Critical Care Medicine*, **152**, S36–39.
- Gwaltney, J.M. Jr and Hendley, J.O. (1978) Rhinovirus transmission: one if by air, two if by hand. *American Journal of Epidemiology*, **107**, 357–361.
- Gwaltney, J.M. Jr, Phillips, C.D., Miller, R.D. *et al.* (1994) Computed tomographic study of the common cold. *New England Journal of Medicine*, **330**, 25–30.
- Hadfield, A.T., Lee, W.M., Zhao, R. *et al.* (1997) The refined structure of human rhinovirus 16 at 2.15 Å resolution: implications for the viral life cycle. *Structure*, **5**, 427–441.
- Hamory, B.H., Hamparian, V.V., Conant, R.M. *et al.* (1975) Human responses to two decavalent rhinovirus vaccines. *Journal of Infectious Diseases*, **132**, 623–629.
- Hamparian, V.V., Colonna, R.J., Cooney, M.K. *et al.* (1987) A collaborative report: rhinoviruses—extension of the numbering system from 89–100. *Virology*, **159**, 191–192.
- Hippocrates (c. 400 BC) *On Ancient Medicine*, Part 18, 1–15.
- Hofer, F., Gruenberg, M., Kowalski, H. *et al.* (1994) Members of the low density lipoprotein receptor family mediate cell entry of a minor-group common cold virus. *Proceedings of the National Academy of Sciences of the USA*, **91**, 1839–1842.
- Hogle, J.M., Chow, M. and Filman, D.J. (1985) Three dimensional structure of poliovirus at 2.9 Å resolution. *Science*, **229**, 1358–1365.
- Horsnell, C., Gama, R.E., Hughes, P.J. *et al.* (1995) Molecular relationships between 21 human rhinovirus serotypes. *Journal of General Virology*, **76**, 2549–2555.
- Hsia, J., Goldstein, A.L., Simon, G.L. *et al.* (1990) Peripheral blood mononuclear cell interleukin-2 and interferon-gamma production, cytotoxicity, and antigen-stimulated blastogenesis during experimental infection. *Journal of Infectious Diseases*, **162**, 591–597.
- Huguenel, E.D., Cohn, D., Dockum, D.P. *et al.* (1997) Prevention of rhinovirus infection in chimpanzees by soluble intercellular adhesion molecule-1. *American Journal of Respiratory and Critical Care Medicine*, **155**, 1206–1210.
- Igarashi, Y., Skoner, D.P., Doyle, W.J. *et al.* (1993) Analysis of nasal secretions during experimental rhinovirus upper respiratory infections. *Journal of Allergy and Clinical Immunology*, **92**, 722.
- Jackson, R.J., Howell, M.T. and Kaminski, A. (1990) The novel mechanism of initiation of picornavirus RNA translation. *Trends in Biochemical Sciences*, **15**, 477–483.
- Johnston, S.L. (1995) Natural and experimental rhinovirus infections of the lower respiratory tract. *American Journal of Respiratory and Critical Care Medicine*, **152**, S46–52.
- Johnston, S.L. (1997) Problems and prospects of developing effective therapy for common cold viruses. *Trends in Microbiology*, **5**, 58–63.
- Johnston, S.L. and Tyrrell, D.A.J. (1995) Rhinoviruses. In *Diagnostic Procedures for Viral, Rickettsial and Chlamydial Infections* (eds E.H. Lennette and N.L. Schmidt), pp 553–564. American Public Health Association, Washington DC.
- Johnston, S.L., Bardin, P.G. and Pattemore, P.K. (1993a) Viruses as precipitants of asthma symptoms. III. Rhinoviruses: molecular virology and prospects for future intervention. *Clinical and Experimental Allergy*, **23**, 237–246.
- Johnston, S.L., Sanderson, G., Pattemore, P.K. *et al.* (1993b) Use of polymerase chain reaction for diagnosis of picornavirus infection in subjects with and without respiratory symptoms. *Journal of Clinical Microbiology*, **31**, 111–117.
- Johnston, S.L., Pattemore, P.K., Sanderson, G. *et al.* (1995) Community study of role of viral infections in exacerbations of asthma in 9–11 year old children. *BMJ*, **310**, 1225–1228.
- Johnston, S.L., Pattemore, P.K., Sanderson, G. *et al.* (1996) The relationship between upper respiratory infections and hospital admissions for asthma: a time-trend analysis. *American Journal of Respiratory and Critical Care Medicine*, **154**, 654–660.
- Killington, R.A., Stott, E.J. and Lee, D. (1977) The effect of temperature on the synthesis of rhinovirus type 2 RNA. *Journal of General Virology*, **36**, 403–411.
- Levandowski, R.A. (1992) Rhinoviruses. In *Infectious Diseases* (eds S.L. Gorbach, J.G. Bartlett and N.R. Blacklow), pp 1780–1787. W.B. Saunders, Philadelphia.
- Macnaughton, M.R. (1982) The structure and replication of rhinoviruses. *Current Topics in Microbiology and Immunology*, **97**, 1–26.
- Meschievitz, C.K., Schultz, S.B. and Dick, E.C. (1984) A model for obtaining predictable natural transmission of rhinoviruses in human volunteers. *Journal of Infectious Diseases*, **150**, 195–201.
- Montefort, S. and Holgate, S.T. (1991) Adhesion molecules and their role in inflammation. *Respiratory Medicine*, **85**, 91–99.
- Monto, A.S. (1995) Viral respiratory infections in the community: epidemiology, agents and interventions. *American Journal of Medicine*, **99(6B)**, 24S–27S.
- Monto, A.S., Bryan, E.R. and Ohmit, S. (1987) Rhinovirus infections in Tecumseh, Michigan: frequency of illness and number of serotypes. *Journal of Infectious Diseases*, **156**, 43–49.
- Mori, J. and Clewley, J.P. (1994) Polymerase chain reaction and sequencing for typing rhinovirus RNA. *Journal of Medical Virology*, **44**, 323–329.
- Naclerio, R.M., Proud, D., Lichtenstein, L.M. *et al.* (1988) Kinins are generated during experimental rhinovirus colds. *Journal of Infectious Diseases*, **157**, 133–145.
- Nicholson, K.G., Kent, J., Hammersley, V. *et al.* (1997) Acute viral infections of upper respiratory tract in elderly people living in the community: comparative, prospective, population based study of disease burden. *BMJ*, **315**, 1060–1064.
- Olive, D.M., Al-Mufti, S., Al-Mulla, W. *et al.* (1990) Detection and differentiation of picornaviruses in clinical samples fol-

- lowing genomic amplification. *Journal of General Virology*, **71**, 2141–2147.
- Papi, A., Wilson, S.J., Holgate, S.T. *et al.* (1998) Rhinovirus infection induces expression of its own receptor (ICAM-1) and VCAM-1 in respiratory epithelium by transcriptional mechanisms involving NF- κ B and GATA. *Journal of Biological Chemistry* (in press).
- Patterson, L.J. and Hamparian, V.V. (1997) Hyper-antigenic variation occurs with human rhinovirus type 17. *Journal of Virology*, **71**, 1370–1374.
- Pitkaranta, A., Arruda, E., Malmberg, H. *et al.* (1997) Detection of rhinovirus in sinus brushings of patients with acute community-acquired sinusitis by reverse transcription-PCR. *Journal of Clinical Microbiology*, **35**, 1791–1793.
- Proud, D., Gwaltney, J.M. Jr, Hendley, O. *et al.* (1994) Increased levels of interleukin-1 are detected in nasal secretions of volunteers during experimental rhinovirus colds. *Journal of Infectious Diseases*, **169**, 1007–1113.
- Rossmann, M.G. and Palmenberg, A.C. (1988) Conservation of the putative receptor attachment site in picornaviruses. *Virology*, **164**, 373–382.
- Rossmann, M.G. and Arnold, E., Erickson, J.W. *et al.* (1985) Structure of human common cold virus and functional relationship to other picornaviruses. *Nature*, **317**, 145–153.
- Rossmann, M.G., Olson, N.H., Kolaktar, P.R. *et al.* (1994) Crystallographic and cryo EM analysis of virion-receptor interactions. *Archives of Virology. Supplementum*, **9**, 531–541.
- Rowlands, D.J. (1995) Rhinoviruses and cells: molecular aspects. *American Journal of Respiratory and Critical Care Medicine*, **152**, S31–35.
- Sattar, S.A., Jacobsen, H., Springthorpe, V.S. *et al.* (1993) Chemical disinfection to interrupt transfer of rhinovirus type 14 from environmental surfaces to hands. *Applied and Environmental Microbiology*, **59**, 1579–1585.
- Sherry, B., Mosser, A.G., Colonno, R.J. *et al.* (1986) Use of monoclonal antibodies to identify four neutralization immunogens on a common cold picornavirus, human rhinovirus 14. *Journal of Virology*, **57**, 246–257.
- Skoner, D.P., Whiteside, T.L., Wilson, J.W. *et al.* (1993) Effect of rhinovirus 39 infection on cellular immune parameters in allergic and nonallergic subjects. *Journal of Allergy and Clinical Immunology*, **92**, 732–743.
- Staunton, D.E., Merluzzi, V.J., Rothlein, R. *et al.* (1989) A cell adhesion molecule, ICAM-1, is the major receptor for rhinovirus. *Cell*, **56**, 849–853.
- Staunton, D.E., Dustin, M.L., Erickson, H.P. *et al.* (1990) The arrangement of the immunoglobulin like domains of ICAM-1 and the binding sites for LFA-1 and rhinovirus. *Cell*, **61**, 243–254.
- Teran, L.M., Johnston, S.L., Schroder, J.M. *et al.* (1997) Role of nasal interleukin-8 in neutrophil recruitment and activation in children with virus-induced asthma. *American Journal of Respiratory and Critical Care Medicine*, **155**, 1362–1366.
- Tomassini, J.E., Graham, D., DeWitt, C.M. *et al.* (1989) cDNA cloning reveals that the major group rhinovirus receptor on HeLa cells is intercellular adhesion molecule 1. *Proceedings of the National Academy of Sciences of the USA*, **86**, 4907–4911.
- Tyrrell, D.A.J. and Parsons, R. (1960) Some virus isolations from common colds. III. Cytopathic effects in tissue cultures. *Lancet*, **i**, 239–242.
- Uncapher, C.R., DeWitt, C.M. and Colonno, R.J. (1991) The major and minor group receptor families contain all but one human rhinovirus serotypes. *Virology*, **180**, 814–817.
- Wald, T.G., Shult, P., Krause, P. *et al.* (1995) A rhinovirus outbreak among residents of a long-term care facility. *Annals of Internal Medicine*, **123**, 588–593.
- Wilson, R., Alton, E., Rutman, A. *et al.* (1987) Upper respiratory tract infection and mucociliary clearance. *European Journal of Respiratory Diseases*, **70**, 272–279.
- Winther, B., Gwaltney, J.M. Jr, Mygind, N. *et al.* (1986) Sites of rhinovirus recovery after point inoculation of the upper airway. *JAMA*, **256**, 1763–1767.
- Wong, G.H.W. and Goddel, D.V. (1986) Tumor necrosis factor α and β inhibit virus replication and synergize with interferons. *Nature*, **323**, 819–822.
- Zhu, Z., Tang, W., Ray, A. *et al.* (1996) Rhinovirus stimulation of interleukin-6 *in vivo* and *in vitro*. Evidence for nuclear factor κ - β -dependent transcriptional activation. *Journal of Clinical Investigation*, **97**, 421–430.

Coronaviruses and Toroviruses

David Cavanagh

Institute for Animal Health, Newbury, UK

INTRODUCTION

Human coronaviruses (HCVs) are usually thought of in the context of the common cold and, indeed, these viruses are responsible for up to one-third of colds. There is also evidence for coronaviruses being associated with enteric disease in humans. HCVs can grow in some neural cells *in vitro* and have been associated with cases of multiple sclerosis, although the role of the coronavirus in such cases is not clear. The alimentary tract is certainly a site of replication of toroviruses, including those of humans; these viruses superficially resemble coronaviruses, with which they may be confused.

Coronaviruses were first isolated in humans in the mid-1960s (Tyrrell and Bynoe, 1965; Hamre and Procknow, 1966). The original coronavirus strains were passaged in organ cultures of human embryonic trachea or nasal epithelium and in primary human kidney cell cultures. Subsequently several other HCVs have been isolated in organ or tissue cultures. The majority of HCVs studied to date are serologically related to one of two reference strains, 229E and OC43. Molecular analysis has shown that these two viruses differ extensively from each other; they are distinct species of coronavirus, not simply variants of each other.

Toroviruses were first isolated from diarrhoeic horse in 1972 (*Berne virus*, BEV) and neonatal calves 1982 (bovine torovirus, BoTV, strain *Breda virus*, BRV) (Weiss and Horzinek, 1987). Subsequently particles resembling these two viruses were observed by electron microscopy in the stools of

children and adults with diarrhoea (Beards *et al.*, 1984). The human viruses formed immunocomplexes with anti-BEV and BoTV sera. Much less is known about human toroviruses than coronaviruses.

THE VIRUSES

The coronaviruses, in the single genus *Coronavirus*, were for many years the only members of the family *Coronaviridae*. Recently the genus *Torovirus* was included in this family. Moreover, certain characteristics relating to genome organization, transcription and translation resulted in the creation of the order *Nidovirales* comprising the families *Coronaviridae* and *Arteriviridae* (Cavanagh, 1997; de Vries *et al.*, 1997). No arteriviruses, which are morphologically distinct from coronaviruses and toroviruses, have yet been discovered in humans.

Both coronaviruses and toroviruses comprise RNA-containing viruses of similar size and gross appearance. The coronaviruses are largely associated with respiratory and enteric infections in mammals and birds, while to date the fewer known toroviruses have been associated with diarrhoea (Dales and Anderson, 1995; Koopmans and Horzinek, 1995; Myint, 1995; Siddell, 1995a; Lai and Cavanagh, 1997). The large surface projections of the coronaviruses gave them an appearance reminiscent of a crown, hence the name coronaviruses (Latin *corona*, crown; Figures 10.1 and 10.2). The doughnut shape sometimes seen within torovirus

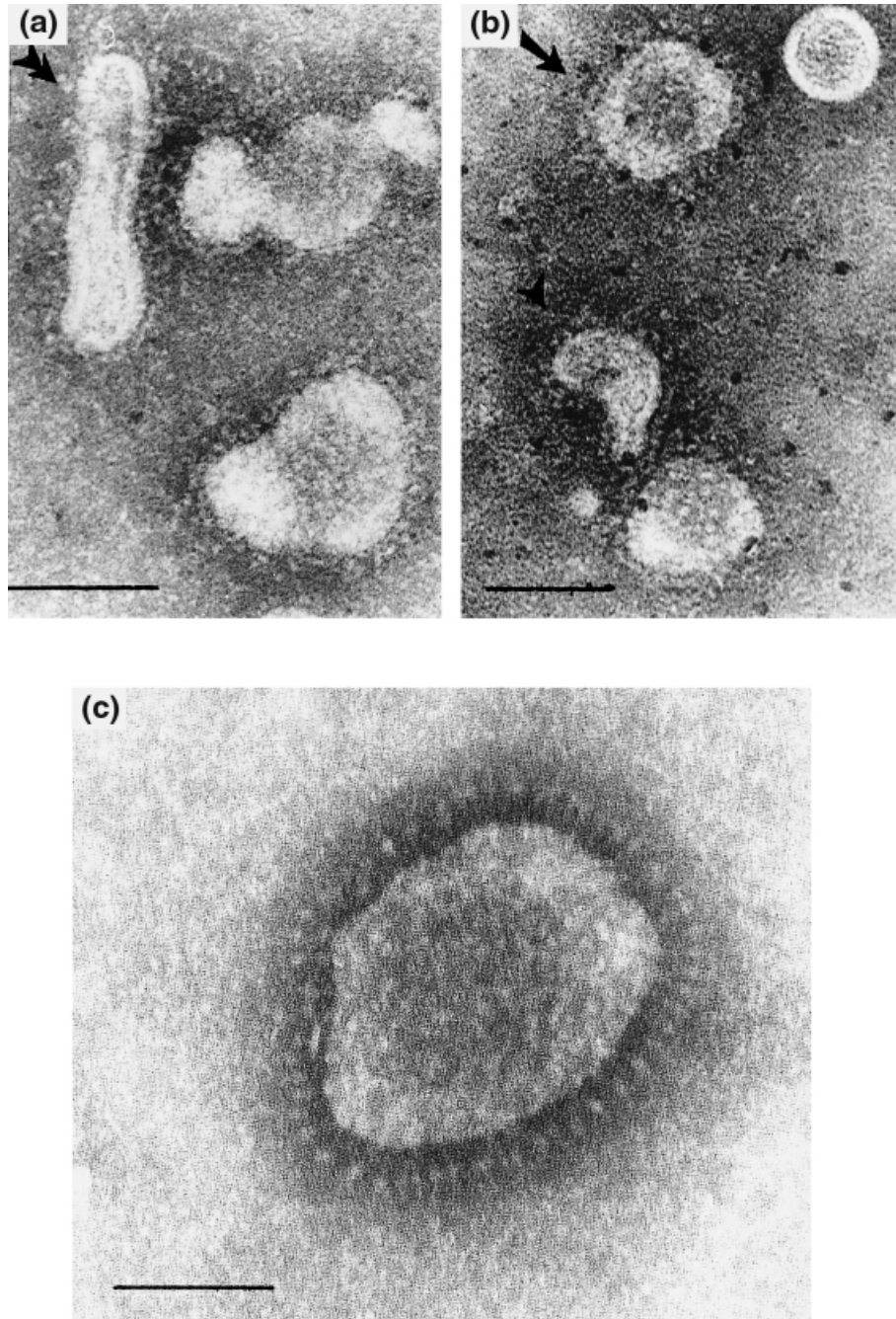

Figure 10.1 Electronmicrographs of (a, b) human enteric torovirus showing torus (arrow), crescent (arrow head) and rod (double arrow head), and (c) a human enteric coronavirus. The latter has spikes which are more prominent and readily discernible than those of the torovirus. The shorter, 10 nm, projections on the torovirus particles may be the haemagglutinin-esterase protein (HE). (Bar = 100 nm) (Reprinted from Duckmanton *et al.* (1997) by permission of Academic Press)

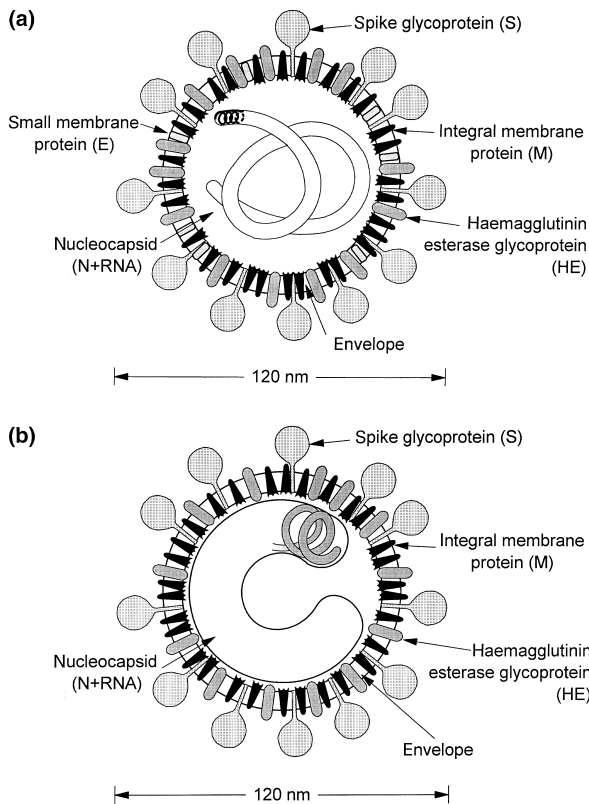

Figure 10.2 Virions of (a) a coronavirus and (b) a torovirus. The HE protein is possessed by HCV-OC43 but not by HCV-229E. Similarly, an HE protein is possessed by some, though not all, toroviruses. (Reproduced from Cavanagh, D. *et al.* (1994) *Archives of Virology*, **135**, 228–239, with permission of Springer-Verlag, Vienna)

particles resulted in the use of the root ‘toro’, from the Latin *torus*, the lowest convex moulding in the base of a column (Figures 10.1 and 10.2). Coronaviruses such as HCV and *Avian infectious bronchitis virus* (IBV) of chickens are most notable for growth in respiratory tissues, although IBV can infect kidney, oviduct and enteric tissues and some HCV strains infect enteric tissues. Other coronaviruses such as *Canine coronavirus* (CCV), *Bovine coronavirus* (BCV), turkey coronavirus (TCV), some strains of *Feline coronavirus* (FCV), *Porcine transmissible gastroenteritis virus* (TGEV) and *Porcine epidemic diarrhoea virus* (PEDV) replicate predominantly in enteric tissues but also replicate to a lesser extent, and probably initially, in the respiratory tract. Some strains of FCV infect macrophages and cause infectious peritonitis, hence the

name *Feline infectious peritonitis virus* (FIPV). *Murine hepatitis virus* (MHV, murine coronavirus) strains, in addition to infecting one or more of respiratory, enteric and hepatic tissues, replicate in cells of the central nervous system, causing encephalitis and demyelination (Dales and Anderson, 1995; Houtman and Fleming, 1996). *Porcine haemagglutinating encephalomyelitis virus* (HEV) also selectively infect neuronal tissue. Coronaviruses have been assigned to one of groups 1, 2 and 3 (Table 10.1) on the basis of amino acid sequences, supported to some extent by antigenic analyses.

Structure

Coronaviruses are pleomorphic, ether-labile, enveloped viruses with diameters ranging from 60 to 220 nm and have a buoyant density in sucrose of $1.15\text{--}1.18\text{ ml}^{-1}$ (as do toroviruses). The particles are often described as having club-shaped surface projections or spikes (S) of up to 20 nm in length, although the shape varies among the species. Particles may be seen with incomplete coronas of spikes.

Toroviruses are 100–140 nm in diameter and are variously described as being doughnut-, disc-, kidney- or rod-shaped, depending on the angle of view. The large spikes of BEV and BoTV measure approximately 17–20 nm in length and are not unlike those of some coronaviruses in appearance (Weiss *et al.*, 1983). However, many particles of BEV, which had been prepared for electron microscopy were devoid of the 20 nm S protein, the virions having a smooth surface (Weiss *et al.*, 1983). Similarly, electron microscopy of BoTV has revealed few of the 20 nm spikes but rather an intact fringe of smaller spikes, some 7–9 nm in length (Woode *et al.*, 1982; Cornelissen *et al.*, 1997). The toroviruses recently isolated from human faeces had an intact fringe of 10 nm spikes (Duckmanton *et al.*, 1997), which resembled those seen on human toroviruses by Beards and colleagues (Beards *et al.*, 1984). The latter reported observing the 20 nm spikes only rarely. It is possible that the 10 nm spikes observed by Duckmanton and colleagues are haemagglutinin-esterase (HE) protein. It has recently been shown that BoTV, in contrast to BEV (which has an incomplete HE gene, a pseudogene) has an HE protein which forms a fringe of spikes approximate-

Table 10.1 Coronavirus groups

Group 1	Group 2	Group 3
HCV-229E	HCV-OC43	IBV
CCV	BCV	TCV
FCV (FIPV)	HEV	
PEDV	MHV	
TGEV		

ly 6 nm in length (Cornelissen *et al.*, 1997). The toroviruses described by Duckmanton and colleagues did cause haemagglutination (Duckmanton *et al.*, 1997).

Both genera have genomes which are non-segmented, single-stranded RNA of approximately 30 000 nucleotides and positive polarity (de Vries *et al.*, 1997). Species of each genus produce five or more subgenomic mRNAs which form a 3'-co-terminal nested set. The coronaviruses also have a common 5'-terminal leader sequence derived from the 5' end of the genome; this has not been observed for toroviruses.

Both genera contain, in addition to S, a smaller integral membrane protein (M), largely embedded in the virus envelope, and a nucleocapsid protein (N), which surrounds the genome (Figure 10.2). Virions of coronaviruses also possess another membrane-associated protein, E (for envelope; also referred to as sM), comprising about 80–110 amino acids. A function has not yet been assigned to this protein, although it is essential for virus particle formation. Human coronaviruses of the OC43, but not 229E, group contain an additional protein, the HE protein, which forms a 5 nm layer of surface projections. As described above, BoTV has an HE protein which is absent from BEV, as this virus has an incomplete HE gene (Cornelissen *et al.*, 1997). The BoTV HE protein has approximately 30% amino acid sequence identity with that of coronaviruses and *Influenza C virus*.

The reader is referred to Brian *et al.* (1995), Cavanagh (1995), Laude and Masters (1995), Rotter (1995), Siddell (1995b), Snijder and Horzinek (1995), Cornelissen *et al.* (1997) and Lai and Cavanagh (1997) for comprehensive reviews, including references to gene sequences, of coronavirus and torovirus proteins.

Sequence of HCV and Torovirus Proteins

Several HCV genes have been cloned and sequenced. The heavily glycosylated S glycoprotein of HCV-229E comprises 1173 amino acids. Whereas the S proteins of some coronaviruses, e.g. IBV, are efficiently cleaved into two subunits, S1 and S2, the S of HCV-229E grown in human embryonic lung cells is not cleaved. In accord with this, sequencing shows that the HCV-229E S protein lacks a highly basic sequence such as occurs in IBV at the S1–S2 cleavage site. Most of the S of HCV-OC43 grown in a human rectal tumour cell line is not cleaved but addition of trypsin cleaves S into S1 and S2. This indicates that the extent to which the S of HCV-OC43 is cleaved in various cell types depends in part on the presence in the cells of proteases which cleave adjacent to a basic S1–S2 connecting peptide, a situation which also applies to MHV. The S protein of HCV-OC43 is appreciably larger, at 1353 amino acids, than that of HCV-229E.

The S protein of Berne torovirus comprises 1581 amino acids and, like S of HCV strains, has an M_r of about 200 kDa when glycosylated. It has a highly basic S1–S2 connecting peptide and occurs as two subunits in virions.

The M proteins of HCV-229E, OC-43 and BEV torovirus comprise 225, 230 and 233 amino acids, respectively, of which probably only 10%, associated with one N-linked oligosaccharide in the case of HCV-229E and potentially several O-linked oligosaccharides for HCV-OC43, protude at the virion surface.

The different sizes of the N proteins of the 229E (389 amino acids) and OC43 (448 residues) strains serve to emphasize that these two viruses are not simply variants of each other. The N protein of 229E is very similar in size to that of TGEV, with 46% amino acid identity within the first third of the protein, while that of OC43 is identical in size to that of BCV and shares 97.5% identity overall. The N protein of Berne torovirus is much smaller than that of any coronavirus, comprising only 160 amino acids.

Strain OC43, in common with other coronaviruses in group 1 (Table 10.1) has an HE glycoprotein which has 95% amino acid identity with the HE of BCV strain G95. Remarkably, the coronavirus and torovirus HE proteins have 30%

sequence identity with the haemagglutinin-esterase-fusion (HEF) protein of *Influenza C virus*. Two functions have been assigned to coronavirus HE protein, receptor-binding and receptor-destroying (see below). The human toroviruses of Duckmanton *et al.* (1997) agglutinated rabbit and human erythrocytes. Coronavirus 229E lacks HE, in common with other group 2 and group 3 members (Table 10.1), and BEV also lacks HE.

Antigenic Structure

Virus-neutralizing (VN) antibodies are induced by both the S and HE proteins of coronaviruses (reviewed by Cavanagh, 1995), and some antibodies against the M protein neutralize virus in the presence of complement. Monoclonal antibodies have shown that neutralizing and haemagglutination-inhibiting antibodies are induced by the torovirus S protein.

Epitope mapping of coronaviruses has been done mostly for S and has shown that VN epitopes are formed largely by the amino-terminal S1 half of the protein, which correlates with the much greater amino acid sequence variation in S1 than in S2 (Cavanagh, 1995). Removal of glycans from S of IBV greatly diminished the binding of VN monoclonal antibodies. The S protein has been shown to be a major inducer of protective immunity, although the other structural proteins, particularly the nucleocapsid protein, contribute to the induction of protection. In the case of FIPV it is the immune response to S which exacerbates the disease. It is thought that FIPV attached to anti-S antibody remains infectious and is more readily taken up by macrophages (antibody-dependent enhancement), in which FIPV replicates, than virus without antibody (de Groot and Horzinek, 1995).

Coronaviruses have been placed into one of three groups (Table 10.1). Species have higher amino acid identities with viruses within their group than with those in the other groups. Previously the groups had been referred to as serological groups. This, however, was misleading, as some members e.g. HCV-229E and PEDV, had only low antigenic cross-reactivity with other members of group 1. Until recently TCV had been in group 2 but recent sequence and antigenic analyses have indicated that it should be assigned to group 3 (Stephenson *et al.*, 1999).

Only one strain of BEV has been isolated. Strains of BRV have been divided into two serotypes and BEV and BRV share some epitopes. Immune electron microscopy has revealed relationships between these viruses and human torovirus (Beards *et al.*, 1984; Duckmanton *et al.*, 1997). Much remains to be done to establish the extent of variation among human toroviruses.

Growth *In Vitro*

Previously OC43 and serologically related strains of HCV were considerably more difficult to propagate in cell culture than 229E-related strains and so organ cultures were used for OC43, hence the letters 'OC'. Now, however, cell lines are available for the propagation of both of the laboratory-adapted HCV types (consult HCV sequence papers referred to above), although primary isolation remains difficult (Myint, 1994, 1995). Cultures of fetal and adult astrocytes were infected by both types of HCV but infectious virus was only released from the fetal cells (Bonavia *et al.*, 1997). Human torovirus has not been grown *in vitro*.

CELL RECEPTORS FOR HCVs

Attachment of Coronaviruses to Cells

The attachment of a virus to host cells is a crucial early step in infection, and specificity of attachment can be a major factor in determining host cell range and hence pathogenesis. This has been elegantly demonstrated by the transfer of coronavirus receptors from susceptible cells to other cells, rendering the latter susceptible to infection. It is the S protein that serves to attach the virus to cells. The extent to which the HE protein, when present, is also responsible for cell attachment is not clear. This topic has been reviewed by Holmes and Compton (1995) and Lai and Cavanagh (1997).

Human aminopeptidase N (APN) has been identified as a receptor for HCV-229E (Yeager *et al.*, 1992). This protein is a metalloprotease located on the surface of epithelial cells, including those of the intestine, lung and kidney. Porcine APN is the receptor for TGEV (Delmas *et al.*, 1992). TGEV replicates mostly in enterocytes of the small intestine

and produces its greatest tissue damage at this site but it also replicates to a lesser degree within the respiratory tract. This correlates with the incidence of APN, which is greater in the small intestine than in lung tissue.

The cellular receptor for MHV is a member of the carcinoembryonic antigen (CEA) family of glycoproteins in the immunoglobulin superfamily (reviewed by Lai and Cavanagh, 1997). This CEA protein is a 424 amino acid glycoprotein with four immunoglobulin-like domains. Human and hamster cells, refractory to infection by MHV, became susceptible to MHV when this receptor was expressed following transfection with the murine CEA gene (Dveksler *et al.*, 1991). Chen *et al.* transfected COS-7 cells, which lack a functional receptor for MHV, with genes of human CEA and human biliary glycoprotein; the cells were then susceptible to MHV (Chen *et al.*, 1997). Experiments with chimeras of human and murine CEAs revealed that the immunoglobulin loop of human CEA conferred virus-binding specificity. Different isoforms of murine CEAs exist. These have extensive differences in the amino-terminal immunoglobulin-like domain to which MHV binds, and bind MHV to different extents. Analysis of chimeras indicated that amino acids 38–43 were key elements for binding MHV and virus-induced membrane fusion (Rao *et al.*, 1997).

Human cells which were not susceptible to CCV or FCV became susceptible when transfected with a human/canine chimera of APN (Benbacar *et al.*, 1997). The critical, carboxy-terminal domain was formed by amino acids 643–841 of the canine APN. When amino acids 255–348 of porcine APN were replaced by amino acids 260–353 of human APN, the resulting chimeric protein was able to function as a receptor for HCV-229E (Kolb *et al.*, 1996). Thus different parts of APN molecules may function as receptors for different coronaviruses within viruses of group 2 (Table 10.1). Expression of feline APN in rodent cells rendered the cells susceptible not only to FCV but also to HCV-229E, CCV and TGEV (Tresnan *et al.*, 1996). Previous work had shown, however, that human APN would bind HCV-229E but not TGEV, while porcine APN would bind TGEV but not HCV.

Less work has been done on the receptor for HCV-OC43. Collins (1995) has demonstrated that OC43 binds to major histocompatibility complex class I molecules.

Involvement of Glycans

Both the S and HE proteins of BCV bind to cell surface components, a vital component of which is the glycan component *N*-acetyl-9-*O*-acetylneuraminic acid (Neu5,9Ac₂). This residue acts as a receptor not only on erythrocytes but also on susceptible tissue culture cells (Schultze and Herrler, 1992). The S protein binds more efficiently than HE to Neu5,9Ac₂ and it has been proposed that the BCV S protein is responsible for the primary attachment to cells (Schultze and Herrler, 1992). The HEF glycoprotein of influenza C virus also binds to Neu5,9Ac₂, while influenza A and B viruses do not (Vlasak *et al.*, 1988).

It has been proposed that the attachment of coronaviruses might be a two-step process. Primary attachment might be mediated by a first receptor, e.g. Neu5,9Ac₂, for some coronaviruses, a second receptor, e.g. APN or CEA proteins, bringing the virus and cell membranes closer together. The latter step might be necessary for the fusion of the two membranes for the release of the virus genome. Some receptors might fulfil both functions for some coronaviruses.

IBV (and TGEV) attaches to α 2,3-linked neuraminic acid on erythrocytes and, provided that the virions are first treated with neuraminidase (from *Vibrio cholerae* or *Newcastle disease virus*), can cause haemagglutination (Schultze *et al.*, 1992). This removes α 2,3-linked neuraminic acid, which is present on the S protein of the virus and interferes with the attachment of the S protein to neuraminic acid on the erythrocyte surface. In view of the finding that TGEV attaches to porcine enterocytes, as opposed to erythrocytes, via APN, it may be that either α 2,3-linked neuraminic acid does not play a role in the attachment to these susceptible cells or that it may function as a primary receptor, insufficient for efficient infection, part of APN forming a secondary receptor essential for efficient infection.

The role played by the HE protein where present, e.g. in HCV-OC43, is not clear. Although it can mediate binding to erythrocytes, the main function of HE might be to remove neuraminic acid from the virus and cell surface. The esterase activity of the HE, and HEF protein of influenza C, specifically cleaves Neu5,9Ac₂ and does not hydrolyse the receptors for influenza A and B. Following haemagglutination at 4°C, subsequent incubation at 37°C

results in the destruction of the neuraminic acid and subsequent elution of the virus and reversal of the haemagglutination.

CLINICAL FEATURES

Diseases associated with coronaviruses in humans have been reviewed by Myint (1994).

Upper Respiratory Tract Disease

Most information on the clinical features of HCV infections in humans has been obtained from volunteers experimentally infected with HCVs, and epidemiological studies using paired sera collected from individuals during and after naturally acquired HCV infections. HCVs are believed to be second only to rhinoviruses with respect to the percentage of colds that they cause.

HCVs generally cause mild upper respiratory tract infections in humans, and up to 30% of common colds are caused by HCVs. The incubation period of HCV infections is relatively short, with a range of 2–5 days to the development of symptoms. Illness—nasal discharge, mild sore throat, sneezing, general malaise, perhaps with headache (Tyrrell *et al.*, 1993)—then lasts for an average of 6–7 days, sometimes lasting for 18 days. Fever and coughing may be exhibited in 10% and 20% of cases, respectively. No difference is observed between 229E and OC43 strains in the pathology of infection. Generally symptoms are indistinguishable from those of colds caused by rhinoviruses. Virus excretion reaches a detectable level at the time symptoms begin and lasts for 1–4 days. Subclinical or very mild infections are common and can occur throughout the year.

An electron microscopic examination of the nasal epithelium of a person infected by HCV revealed virus particles within and outside the ciliated cells but neither within or outside the goblet cells or other cells of the nasal mucosa (Afzelius, 1994). The ciliated cells seemed not to be destroyed, although in many cases the cilia were withdrawn. This loss of cilia was considered likely to cause rhinorrhoea.

Lower Respiratory Tract Disease

There have been some reports indicating a more serious lower tract involvement in young children and old people (Isaacs *et al.*, 1983). It is not clear that HCVs infect the lower respiratory tract but the occurrence of HCV upper respiratory tract infections coupled with other factors may cause more serious disease. Up to 30% of acute wheezing episodes in asthmatic children may be due to coronavirus infection.

A study in a neonatal intensive care unit revealed that all premature infants infected with coronaviruses had symptoms of bradycardia, apnea, hypoxaemia, fever or abdominal distention. Chest X-ray revealed diffuse infiltrates in two cases (Sizun *et al.*, 1995).

Molecular Bases of Tropisms

Little is known about the molecular basis of the tropism of human coronaviruses and toroviruses. Observations made with MHV are instructive in this regard. Variation in the sequence of S would appear to have marked effects on tissue tropism and pathogenicity. Mutations in S of MHV were associated with the rate of spread of the virus in neurons and whether the infection resulted in demyelination or encephalitis. Persistent infection of mouse glial cells by MHV resulted in the production of mutants with uncleaved spike protein. These did not cause cell–cell fusion and consequently spread slowly (Gombold *et al.*, 1993). These and other changes in tropism and pathogenicity probably did result from changes in the S gene, although the possibility that mutations had occurred elsewhere in the genome cannot be excluded (Cavanagh, 1995). Gallagher (1997) has shown that a tissue culture-adapted mutant of MHV JHM, the JHMX strain, did not elute from its receptor at 37°C, whereas the parental JHM strain did do so. This difference in interaction with the receptor was associated with a large deletion from the S protein of JHMX.

Epidemiology

Generally HCV epidemics occur during the winter and early spring but the peak period may vary by

several months. However, other periods of high infection rates have been observed and it appears that major peaks may occur at any time of the year. All age groups are infected with HCVs and infection rates have been shown to be relatively uniform for all age groups (Monto and Lim, 1974). This is different from the situation with some other respiratory viruses, such as respiratory syncytial virus, where there is a distinct decrease in infection rates with increase in age.

The incidence of OC43 and 229E types of HCV has been studied in depth among approximately 1000 people in Tecumseh, USA, over a period of 4 years. Serology revealed that 17% of individuals had a cold caused by OC43 in any one year (Monto and Lim, 1974). Infections by 229E in the same community averaged 8% each year, while double this rate was detected elsewhere in another study. In some years the incidence of disease was much greater than the average. In a study in the Rhone Alpes region of France, virus was isolated from approximately one-third of nasal swabs, 18% of these yielding HCV (Lina *et al.*, 1996).

There is a periodicity of infections caused by 229E and OC43 group viruses which follows a complex pattern, although they usually cause peaks of infection with intervals of 2 or 3 years. In general, high infection rates in any particular year are caused by either 229E or OC43 group viruses, with only the occasional sporadic HCV infection belonging to the other group. HCV infections have been shown to occur throughout the world with the same cyclic pattern.

Certain individuals are more prone than others to HCV infections. Reinfection of individuals with the same HCV serotype often occurs within 4 months of the first infection, suggesting that homologous HCV antibodies are protective for about 4 months. In addition, there are indications that antibodies to one HCV group may not be protective against infection with viruses from the other HCV group.

The serological response to both naturally acquired and experimentally induced infections is extremely variable and depends on a number of factors, including the infecting HCV strain and the serological test employed. Many individuals have high antibody levels after infection, and reinfection with the same or related strains is common.

Coronaviruses Associated with the Human Enteric Tract

There has been an increasing number of reports describing coronavirus-like viruses isolated from faecal specimens from humans (Macnaughton and Davies, 1981; Myint, 1994; Duckmanton *et al.*, 1997). Some of these viruses were isolated from infants with necrotizing enterocolitis, patients with non-bacterial gastroenteritis and from homosexual men with diarrhoea who were symptomatic and seropositive for human immunodeficiency virus. Some isolates were shown to be serologically related to OC43. The discovery that a protein found in enterocytes functions as a receptor for HCV-229E strengthens the possibility that coronaviruses might replicate in the human alimentary tract.

Toroviruses Associated with the Human Enteric Tract

Duckmanton and colleagues (1997) have isolated and purified toroviruses from faeces of paediatric patients with gastroenteritis, extending previous work (Beards *et al.*, 1984; Koopmans and Horzinek, 1994). That the viruses detected were indeed toroviruses was demonstrated by nucleotide sequencing. More studies of these little-known viruses may not be expected.

Coronaviruses in the Central Nervous System

Multiple sclerosis (MS) is a chronic disease of the central nervous system involving multifocal regions of inflammation and myelin destruction. A number of environmental factors have been proposed for triggering MS, foremost among them being infectious agents (Kurtze, 1993). Many viruses have been linked with MS, including coronaviruses. Coronavirus-like particles were observed in the brain of an MS patient and titres of antibodies to HCVs were greater in cerebrospinal fluid from MS patients compared to control subjects. Two putative coronaviruses (CV-SD and CV-SK) were isolated after passage in mice of brain material from two MS patients. Doubt has been cast on whether the SD and SK isolates are of human, rather than murine,

origin. However, analysis of brain tissue from MS and non-MS patients by *in situ* hybridization using DNA probes complementary to CV-SD and MHV RNA revealed the presence of nucleic acid to which the probes bound (Murray *et al.*, 1992a). The incidence of this RNA was fivefold greater in the MS patients. Stewart *et al.* (1992) analysed RNA from brain tissue of MS patients using polymerase chain reactions (PCRs) specific for HCVs OC43 and 229E. RNA of the latter type was detected four of 11 MS patients and in none of six neurological and five normal controls. No OC43 RNA was detected.

Although these observations do not prove that coronaviruses cause MS in humans, it should be remembered that strains of MHV cause both acute and chronic infections, including demyelination, of the central nervous system of mice and rats (Dales and Anderson, 1995; Houtman and Fleming, 1996). Moreover, intracerebral inoculation of Owl monkeys and African green monkeys with either MHV or the CV-SD isolate resulted in acute to subacute panencephalitis and/or demyelination. Replication of these viruses was demonstrated by detection of viral RNA and proteins (Murray *et al.*, 1992b). Experiments with MHV and rodents have shown that the virus was able to enter the central nervous system from peripheral trigeminal or olfactory nerves after *intranasal* inoculation (see references in Murray *et al.*, 1992b).

Infection by OC43 in primary cultures of fetal astrocytes and of adult microglia and astrocytes was demonstrated by fluorescence (Bonavia *et al.*, 1997). This technique failed to detect 229E but RNA replication of this type of HCV was detected by PCR and probing of the resultant DNA. Interestingly, only the fetal astrocytes released infectious virus. Clearly HCVs have the capacity to replicate in some cells of the CNS of primates.

One feature of MS is an increased frequency of myelin-reactive T cells, a characteristic also of rodents infected with neurotropic strains of MHV. Transfer of these rodent T cells to naive animals triggered experimental allergic encephalomyelitis (EAE), an autoimmune disease that is used as a model for MS, triggered by injection of myelin basic protein (MBP) (Watanabe *et al.*, 1983). Epitopes common to MBP and MHV—molecular mimicry—have been invoked as the basis of this autoimmunity. HCV-229E has a non-structural protein which has a short amino acid sequence identical to one in MBP (Jouvenne *et al.*, 1992).

Almost one-third of T cell lines established from MS patients, but < 2% from normal control subjects, showed an HLA-DR-restricted cross-reactive pattern of antigen activation after *in vitro* selection with either MBA or HCV-229E antigens (Talbot *et al.*, 1996). This further supports the possibility that molecular mimicry is involved in MS, HCV being one of several pathogens that have exhibited this phenomenon with MBA (reviewed by Talbot *et al.*, 1996).

DIAGNOSIS

Diagnosis of HCV infections is not routinely done in most diagnostic virus laboratories. This is mainly due to their fastidious growth requirements in cell culture and to their inadequate immunological characterization, which makes serological diagnosis difficult. In addition, the infections caused by HCVs have so far proved to be largely of minor clinical significance and therefore have not merited extensive study. However, the application of nucleic acid technology, described below, promises to make detection of human coronaviruses, and toroviruses, much easier.

Diagnostic procedures which have been used comprise virus isolation in cell and/or organ cultures, and serological diagnosis on paired sera from infected individuals (Myint, 1994, 1995).

Virus Isolation

Virus isolation can be done from nasal and throat swabs, and nasopharyngeal aspirates taken from infected individuals.

229E and related strains can be isolated in roller culture monolayers of human embryonic lung fibroblasts, such as W138 and MRC5 cells. In virus-positive cultures a gradual cytopathic effect consisting of small, granular, round cells appears throughout the monolayers, although especially around the periphery of the monolayers. However, cell sheets are rarely destroyed completely on initial isolation. Isolates are generally confirmed as being 229E-related by standard serum neutralization tests. Other cell types that have been used are described by Myint (1995).

OC43-related strains usually cannot be grown in

cell cultures, at least on initial isolation, and for these strains isolation has to be performed in organ cultures of human embryonic tissues. Small pieces of tracheal or nasal epithelium with the ciliated surface uppermost are inoculated with the respiratory specimens and the culture examined for ciliary activity daily for up to 2 weeks. The medium from these preparations is then harvested and examined after negative staining by direct electron microscopy or by immune electron microscopy using convalescent-phase serum from the infected patient. Immobilization or reduction in ciliary activity of infected organ cultures in comparison to that in controls has also been used to identify HCV infection, but this is not a reliable measure of infection.

Serological Diagnosis

229E- and OC43-type infections can be identified using paired serum samples taken from acute and convalescent stages of infection; tests used include virus neutralization, complement fixation and haemagglutination inhibition (for OC43-related strains). A more sensitive method for detecting significant changes in HCV antibody in paired human sera is ELISA.

Detection of HCV Proteins

HCV particles can be detected in epithelial cells shed from the nasopharynx of individuals with coronavirus infections. Indirect immunofluorescence assays have shown that coronavirus fluorescence can be visualized in nasopharyngeal cells from volunteers inoculated with HCVs. An antigen-capture ELISA has been used to detect HCV antigens in nasal and throat swabs, and nasopharyngeal aspirates, taken from children suffering from acute respiratory infections. Nasal swabs were the best specimens for obtaining suitable quantities of antigen for the assay.

Detection of HCV RNA

Cloning of the N gene of HCV-229E made possible the production of a radiolabelled nucleic acid probe which was used in a slot-blot technique to detect

HCV in nasal washings from volunteers infected with 229E. This technique was of comparable sensitivity to standard culture. However, when a non-radioactive probe was used, preferable in a diagnostic laboratory, there was loss of sensitivity (Myint, 1995).

A much more sensitive method of detection is the PCR or, strictly speaking, the reverse transcriptase PCR, as the RNA of HCV must first be copied into DNA by the enzyme reverse transcriptase (RT). Stewart *et al.* (1995) have described a RT-PCR, followed by Southern blotting, for the detection of HCV-229E and OC43 in cerebral autopsy material. Cristallo *et al.* (1996) have also described a RT-PCR and probing method for detecting HCV-OC43. Myint *et al.* (1994) have used a nested RT-PCR to detect HCVs on nasal swabs. This approach, which does not require probing to detect the PCR product, was much more sensitive than cell culture or probe methods. Of all the methods used to detect HCV, the nested PCR would seem to be the one most likely to be used in future. PCR technology is commonly used in major diagnostic laboratories for many purposes. The specific reagents required for HCV detection—oligonucleotides corresponding to an HCV gene—are readily and inexpensively made as the nucleotide sequences of both 229E and OC43 are in the public domain. This approach can also be used to detect coronaviruses in faeces. It is possible, however, that some human coronaviruses present in faeces might have nucleotide sequences significantly different from those of 229E and/or OC43. Degenerate oligonucleotides, possibly based on sequences in the more conserved polymerase gene, might be useful in this regard (Stephenson *et al.*, 1999).

The sequencing of part of the genome of toroviruses present in human faeces is a great advance for the study of these little known viruses, making possible the application of RT-PCR analogous to that described for HCV (Duckmanton *et al.*, 1997).

TREATMENT

As yet there are no treatments which prevent the development of HCV infections. When a human cerebral cortical neuron cell line, in which HCV-OC43 replicated very poorly, was treated with in-

terferon γ , the susceptibility to OC43 was increased 100-fold. This was due to membrane expression of HLA class I which acts as a receptor for OC43 (Collins, 1995). Current studies of the various enzymatic activities within the large polymerase protein of HCV may lead to the development of drugs that would inhibit HCV but have no adverse effect on human cells.

ACKNOWLEDGEMENTS

The author acknowledges financial support from the Ministry of Agriculture, Fisheries and Food, and the Biotechnology and Biological Sciences Research Council, UK.

REFERENCES

- Afzelius, B.A. (1994) Ultrastructure of human nasal epithelium during an episode of coronavirus infection. *Virchows Archiv*, **424**, 295–300.
- Beards, G.M., Hall, C., Green, J. *et al.* (1984) An enveloped virus in stools of children and adults with gastroenteritis that resembles the Breda virus of calves. *Lancet*, **i**, 1050–1052.
- Benbaccer, L., Kut, E., Besnardeau, L. *et al.*, (1997) Interspecies aminopeptidase-N chimeras reveal species-specific receptor recognition by canine coronavirus, feline infectious peritonitis virus, and transmissible gastroenteritis virus. *Journal of Virology*, **71**, 734–737.
- Bonavia, A., Arbour, N., Yong, V.W. *et al.* (1997) Infection of primary cultures of human neural cells by human coronaviruses 229E and OC43. *Journal of Virology*, **71**, 800–806.
- Brian, D.A., Hogue, B.G. and Kienzle, T.E. (1995) The coronavirus hemagglutinin esterase glycoprotein. In *The Coronaviridae* (ed. S.G. Siddell), pp 165–179. Plenum Press, New York.
- Cavanagh, D. (1995) The coronavirus surface glycoprotein. In *The Coronaviridae* (ed. S.G. Siddell), pp 73–113. Plenum Press, New York.
- Cavanagh, D. (1997) *Nidovirales*: a new order comprising *Coronaviridae* and *Arteriviridae*. *Archives of Virology*, **142**, 629–633.
- Chen, D.S., Asanaka, M., Chen, F.S. *et al.*, (1997) Human carcinoembryonic antigen and biliary glycoprotein can serve as mouse hepatitis virus receptors. *Journal of Virology*, **71**, 1688–1691.
- Collins, A.R. (1995) Interferon gamma potentiates human coronavirus OC43 infection of neuronal cells by modulation of HLA class I expression. *Immunological Investigations*, **24**, 977–986.
- Cornelissen, L.A.H.M., Wierda, C.M.H., van der Meer, F.J. *et al.* (1997) Hemagglutinin-esterase, a novel structural protein of torovirus. *Journal of Virology*, **71**, 5277–5286.
- Cristallo, A., Biamonti, G., Battaglia, M. *et al.* (1996) DNA probe for the human coronavirus OC43 also detects neonatal calf diarrhoea coronavirus (NCDCV). *New Microbiologica*, **19**, 251–256.
- Dales, S. and Anderson, R. (1995) Pathogenesis and diseases of the central nervous system caused by murine coronaviruses. In *The Coronaviridae* (ed. S.G. Siddell), pp 257–292. Plenum Press, New York.
- de Groot, R.J. and Horzinek, M.C. (1995) Feline infectious peritonitis. In *The Coronaviridae* (ed. S.G. Siddell), pp 293–315. Plenum Press, New York.
- de Vries, A.A.F., Horzinek, M.C., Rottier, P.J.M. *et al.* (1997) The genome organisation of the *Nidovirales*: similarities and differences between arteri-, toro- and coronaviruses. *Seminars in Virology*, **8**, 33–47.
- Delmas, B., Gelfi, J., L'Haridon, R. *et al.* (1992) Aminopeptidase N is a major receptor for the enteropathogenic coronavirus TGEV. *Nature*, **357**, 417–420.
- Duckmanton, L., Luan, B., Devenish, J. *et al.* (1997) Characterization of torovirus from human faecal specimens. *Virology*, **239**, 158–168.
- Dveksler, G.S., Pensiero, M.N., Cardellichio, C.B. *et al.* (1991) Cloning of the mouse hepatitis virus (MHV) receptor: expression in human and hamster cell lines confers susceptibility to MHV. *Journal of Virology*, **65**, 6881–6891.
- Gallagher, T.M. (1997) A role for naturally occurring variation of the murine coronavirus spike protein in stabilizing association with the cellular receptor. *Journal of Virology*, **71**, 3129–3137.
- Gombold, J.L., Hingley, S.T. and Weiss, S.R. (1993) Fusion-defective mutants of mouse hepatitis virus A59 contain a mutation in the spike protein cleavage signal. *Journal of Virology*, **67**, 4504–4512.
- Hamre, D. and Procknow, J.J. (1966) A new virus isolated from the human respiratory tract. *Proceedings of the Society of Experimental Biology and Medicine*, **121**, 190–193.
- Holmes, K.V. and Compton, S.R. (1995) Coronavirus receptors. In *The Coronaviridae* (ed. S.G. Siddell), pp 55–71. Plenum Press, New York.
- Houtman, J.J. and Fleming, J.O. (1996) Pathogenesis of mouse hepatitis virus-induced demyelination. *Journal of Neurovirology*, **2**, 361–376.
- Isaacs, D., Flowers, C., Clarke, J.R. *et al.* (1983) Epidemiology of coronavirus respiratory infections. *Archives of Disease of Childhood*, **58**, 500–503.
- Jouvenne, P., Mounir, S., Stewart, J.N. *et al.* (1992) Sequence analysis of human coronavirus 229E mRNAs 4 and 5: evidence for polymorphism and homology with myelin basic protein. *Virus Research*, **22**, 125–141.
- Kolb, A.F., Maile, J., Heister, A. *et al.* (1996) Characterization of functional domains in the human coronavirus HCV 229E receptor. *Journal of General Virology*, **77**, 2515–2521.
- Koopmans, M. and Horzinek, M.C. (1994) Toroviruses of animals and humans: a review. *Advances in Virus Research*, **43**, 233–243.
- Koopmans, M. and Horzinek, M.C. (1995) The pathogenesis of torovirus infections in animals and humans. In *The Coronaviridae* (ed. S.G. Siddell), pp 403–414. Plenum Press, New York.
- Kurtz, J.F. (1993) Epidemiologic evidence for multiple sclerosis as an infection. *Clinical Microbiology Reviews*, **6**, 382–427.
- Lai, M.M.C. and Cavanagh, D. (1997) The molecular biology of coronaviruses. *Advances in Virus Research*, **48**, 1–100.
- Laude, H. and Masters, P.S. (1995) The coronavirus nucleocap-

- sid protein. In *The Coronaviridae* (ed. S.G. Siddell), pp 141–163. Plenum Press, New York.
- Lina, B., Valette, M., Foray, S. *et al.* (1996) Surveillance of community-acquired viral infections due to respiratory viruses in Rhone-Alpes (France) during winter 1994 to 1995. *Journal of Clinical Microbiology*, **34**, 3007–3011.
- Macnaughton, M.R. and Davies, H.A. (1981) Human enteric coronaviruses. *Archives of Virology*, **70**, 301–313.
- Monto, A.S. and Lim, S.K. (1974) The Tecumseh study of respiratory illness. VI. Frequency of and relationship between outbreaks of coronavirus infection. *Journal of Infectious Diseases*, **129**, 271–276.
- Murray, R.S., Brown, B., Brian, D. *et al.* (1992a) Detection of coronavirus RNA and antigen in multiple sclerosis brain. *Annals of Neurology*, **31**, 525–533.
- Murray, R.S., Cai, G.Y., Hoel, K. *et al.* (1992b) Coronavirus infects and causes demyelination in primate central nervous system. *Virology*, **188**, 274–284.
- Myint, S., Johnston, S., Sanderson, G. *et al.* (1994) Evaluation of nested polymerase chain methods for the detection of human coronaviruses 229E and OC34. *Molecular and Cellular Probes*, **8**, 35764.
- Myint, S.H. (1994) Human coronaviruses: a brief review. *Reviews in Medical Virology*, **4**, 35–46.
- Myint, S.H. (1995) Human coronavirus infections. In *The Coronaviridae* (ed. S.G. Siddell), pp 389–402. Plenum Press, New York.
- Rao, P.V., Kumari, S. and Gallagher, T.M. (1997) Identification of a contiguous 6-residue determinant in the MHV receptor that controls the level of virion binding to cells. *Virology*, **229**, 336–348.
- Rottier, P.J.M. (1995) The coronavirus membrane glycoprotein. In *The Coronaviridae* (ed. S.G. Siddell), pp 115–139. Plenum Press, New York.
- Schultze, B., Cavanagh, D. and Herrler, G. (1992) Neuraminidase treatment of avian infectious bronchitis coronavirus reveals a hamagglutinating activity that is dependent on sialic acid containing receptors on erythrocytes. *Virology*, **89**, 792–794.
- Schultze, B. and Herrler, G. (1992) Bovine coronavirus uses *N*-acetyl-9-*O*-acetylneuraminic acid as a receptor determinant to initiate the infection of cultured cells. *Journal of General Virology*, **73**, 901–906.
- Siddell, S.G. (ed.) (1995a) *The Coronaviridae*: an introduction. In *The Coronaviridae*, pp 1–10. Plenum Press, New York.
- Siddell, S.G. (ed.) (1995b) The small-membrane protein. In *The Coronaviridae*, pp 181–189. Plenum Press, New York.
- Sizun, F., Soupre, D., Legrand, M.C. *et al.* (1995) Neonatal nosocomial respiratory infection with coronavirus: a prospective study in neonatal intensive care unit. *Acta Paediatrica*, **84**, 617–620.
- Snijder, E.J. and Horzinek, M.C. (1995) The molecular biology of toroviruses. In *The Coronaviridae* (ed. S.G. Siddell), pp 219–238. Plenum Press, New York.
- Stephensen, C.B., Casebott, D.B. and Gangopadhyay, N.N. (1999) Phylogenetic analysis of a highly conserved region of the polymerase gene from 11 coronaviruses and development of a consensus polymerase chain reaction assay. *Virus Research*, **60**, 181–189.
- Stewart, J.N., Arbour, N., Mounir, S. *et al.* (1995) Detection of human coronaviruses in autopsy tissue by RT-PCR. In *Protocols for Diagnosis of Human and Animal Virus Diseases* (eds Y. Becker and G. Darai), pp 349–356. Springer-Verlag, Heidelberg.
- Stewart, J.N., Mounir, S. and Talbot, P.J. (1992) Human coronavirus gene expression in the brains of multiple sclerosis patients. *Virology*, **191**, 502–505.
- Talbot, P.J., Paquette, J.S., Ciurli, C. *et al.* (1996) Myelin basic protein and human coronavirus 229E cross-reactive T cells in multiple sclerosis. *Annals of Neurology*, **39**, 233–240.
- Tresnan, D.B., Levis, R. and Holmes, K.V. (1996) Feline aminopeptidase N serves as a receptor for feline, canine, porcine, and human coronaviruses in serogroup I. *Journal of Virology*, **70**, 8669–8674.
- Tyrrell, D.A., Cohen, S. and Schlarb, J.E. (1993) Signs and symptoms in colds. *Epidemiology and Infection*, **111**, 143–156.
- Tyrrell, D.A.J. and Bynoe, M.L. (1965) Cultivation of a novel type of common cold virus in organ cultures. *BMJ*, **i**, 1467–1470.
- Vlasak, R., Luytjes, W., Spaan, W. *et al.* (1988) Human and bovine coronaviruses recognise sialic acid-containing receptors similar to those of influenza C viruses. *Proceedings of the National Academy of Sciences of the USA*, **85**, 4526–4529.
- Watanabe, R., Wege, H. and ter Meulen, V. (1983) Adoptive transfer of EAE-like lesions from rats with coronavirus-induced demyelinating encephalomyelitis. *Nature*, **305**, 150–153.
- Weiss, M. and Horzinek, M.C. (1987) The proposed family *Toroviridae*: agents of enteric infections. *Archives of Virology*, **92**, 1–15.
- Weiss, M., Steck, F. and Horzinek, M.C. (1983) Purification and partial characterization of a new enveloped RNA virus (Berne virus). *Journal of General Virology*, **64**, 1849–1858.
- Woode, G.N., Reed, D.E., Runnels, P.L. *et al.* (1982) Studies with an unclassified virus isolated from diarrhoeic calves. *Veterinary Microbiology*, **7**, 221–240.
- Yeager, C.L., Ashmun, R.A., Williams, R.K. *et al.* (1992) Human aminopeptidase N is a receptor for coronavirus 229E. *Nature*, **357**, 420–422.

Measles

Sibylle Schneider-Schaulies and Volker ter Meulen

Julius-Maximilians University, Würzburg, Germany

INTRODUCTION

Acute measles is normally a mild disease contracted by children and young adults as a result of infection by the highly contagious *Measles virus* (MV) (ter Meulen and Billeter, 1995). MV is an efficient pathogen, persisting in nature in populations large enough to support it, even though it is able to cause an acute infection in any individual only once in a lifetime. Despite this the virus is distributed worldwide, and virological procedures have been unable to demonstrate significant differences between isolates from different locations. With the advent of molecular epidemiology, however, the existence of at least six cocirculating MV genotypes has been confirmed. Measles is a highly successful virus, which has efficiently exploited its potential for spread. Unlike other viruses (e. g. influenza viruses), MV has no animal reservoir, and although monkeys are susceptible to infection, transmission from animals is not an important means of introducing the disease into a community. Although MV may persist for years in a single individual, these persistent infections are rare and not associated with periodic shedding of infectious virus, as in herpesvirus infections. A single attack of measles is sufficient to confer lifelong immunity to reinfection, even in the absence of re-exposure to the virus. Consequently, in order to remain endemic in a given community, the virus must rely on the infection of the young who are still susceptible. So efficient is the process that the first known report of measles (in Egyptian hieroglyphics) failed to recognize the infectious na-

ture of the illness, and described it as a normal part of child growth and development.

In the prevaccine era in developed countries the maximum incidence of measles was seen in children aged 5–9 years. Infections and epidemics centred around elementary schools, and younger children acquired measles as secondary cases from their school-age siblings. By the age of 20, approximately 99% of subjects tested had been exposed to the virus. With the introduction of the measles vaccine the age incidence and percentage of measles cases in different age groups has changed markedly. In countries with an optimal vaccine utilization, measles infection has shifted to the teenage group, whereas in areas with an ineffective vaccine programme children up to 4 years of age reveal a high primary measles attack rate (Centers for Disease Control, 1991, 1996a, 1996b). In developing countries measles has its greatest incidence in children under 2 years of age. Here the disease is a serious problem with a high mortality (up to 10%) and it has been found that the severity of acute measles and mortality correlate in general with the severity of malnutrition. Therefore, the pattern of epidemiology observed differs markedly in different parts of the world, and a thorough understanding of this is essential to the development of successful vaccination programmes.

THE VIRUS

Although measles has been known for centuries, it

was only with the isolation of the virus by Enders and Peebles in 1954 that experimentation became possible. The development of tissue culture systems, the availability of monoclonal antibodies and molecular biological approaches have then permitted a greater dissection of the virus structure and replication strategy. Experimental approaches to define MV protein functions in detail have long been limited due to the lack of a system that allows a reverse genetic approach. Only recently has a plasmid-based system to rescue infectious MV in tissue culture been developed, making possible the introduction of stable alterations into the viral genome and leading to an understanding of the contribution of any single viral gene product in the MV life cycle and precisely how its functions are exerted (Radecke *et al.*, 1995).

MV is a member of the newly introduced order *Mononegavirales* which includes the *Rhabdoviridae*, *Filoviridae* and *Paramyxoviridae*. As a paramyxovirus, MV reveals structural and biochemical features associated with this group; however, it lacks a detectable virion-associated neuraminidase activity. It has therefore been classified in a separate genus, *Morbillivirus*, of which it is the type species. Other members of this group include: *Peste de petit ruminants virus* (PPRV) which infects sheep and goats; *Rinderpest virus* (RPV), which infects cattle; *Canine distemper virus* (CDV), which infects dogs; *Phocine distemper virus* (PDV), which infects seals and sea-lions; *Dolphin morbillivirus* (DMV); and *Porpoise morbillivirus* (PMV). More recently, a morbillivirus has been isolated in Australia which infects horses, and accidentally humans. All these viruses exhibit antigenic similarities, and all produce similar diseases in their host species. Both MV and CDV can persist in the central nervous system (CNS) and produce chronic neurological diseases.

Morphology

MV particles consist of a lipid envelope surrounding the viral RNP complex which is composed of genomic RNA associated with proteins (Figure 11.1a). Both viral transmembrane proteins (fusion (F) and haemagglutinin (H) proteins) are present on the envelope surface and appear as projections from the particle. Portions of both the F and H proteins extend through the virion envelope (transmem-

brane) and appear on its inside surface (Fraser and Martin 1978). It is the aminoterminal of the H protein that protrudes through the cytoplasmic and viral membranes (type II glycoprotein), while the F protein is anchored near the C-terminus (type I glycoprotein). One or both of the cytoplasmic domains are believed to interact with the matrix (M) protein which, in turn, links the envelope to the RNP core structure. The viral genomic RNA is fully encapsidated by N (nucleocapsid) protein to form the RNP core structure that resists RNase degradation. As the viral genome cannot serve as mRNA, the viral polymerase complex consisting of the P (phospho-) and the L (large) proteins is part of the RNP core complex. Their location within this complex has not yet been resolved. The same holds true for cellular actin which is also known to be packaged into the virion structure.

The virions are highly pleomorphic with an average size of 120–250 nm and both filamentous and irregular forms are known. The virion shown in an electron micrograph is bounded by a lipid envelope which bears a fringe of spike-like projections (peplomers) 5–8 nm long (Figure 11.2a). The membrane below the spikes is 10–20 nm in thickness and encloses the helical viral RNP core which has a diameter of 17 nm and a regular pitch of 5 nm. Immediately below the membrane, M proteins appear as a shell of electron dense material.

Genome Structure

The viral genome is a non-segmented RNA molecule of negative polarity that is about 16 kb in length. The genome, completely sequenced for the MV Edmonston (ED) strain, encodes six structural genes for which the reading frames are arranged linearly and without overlap in the following order: 3' nucleoprotein (N, 60 kDa), phosphoprotein (P, 70 kDa), matrix protein (M, 37 kDa), fusion protein (F, disulphide-linked 41 kDa F₁ and 22 kDa F₂ proteins, cleavage products of a 60 kDa precursor F₀ protein), haemagglutinin protein (H, 80 kDa, existing as disulphide-linked homodimer) and the large protein (L, 220 kDa) encoded on its 5' end (Figure 11.1b) (Rima *et al.*, 1986).

The genome is flanked by non-coding 3' leader and 5' trailer sequences that are thought to contain specific encapsidation signals and the viral promo-

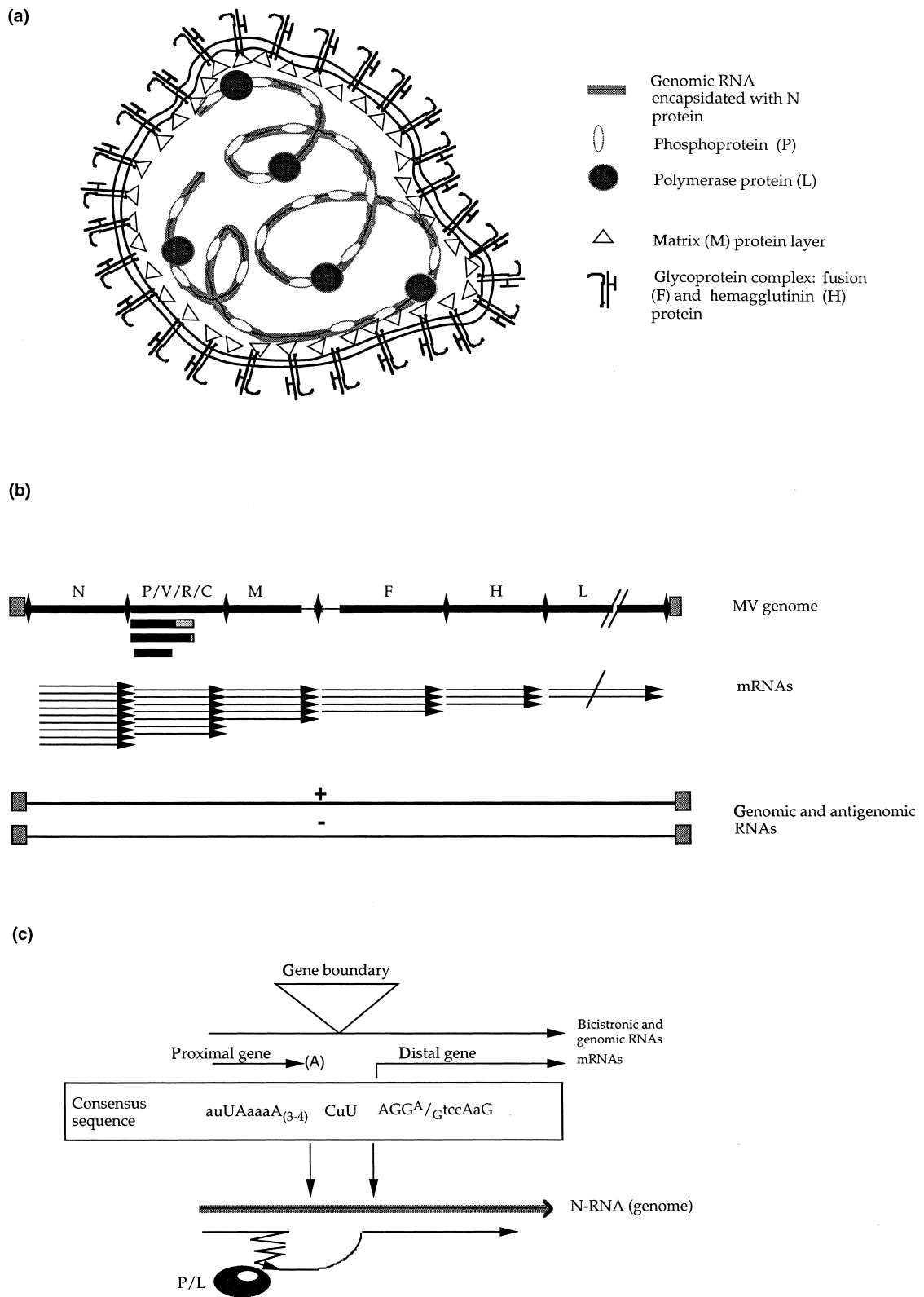

Figure 11.1 (a) Measles virus particle. (b) MV mRNAs are sequentially transcribed from the genome with decreasing efficiency and encode the structural proteins. In addition, the second gene (the P gene) encodes three non-structural viral proteins C, R and V. (c) At the gene boundaries, MV genes are separated by conserved intergenic regions where the polymerase complex stutters to polyadenylate the proximal mRNA to subsequently reinitiate transcription of the downstream gene. Alternatively, these signals are neglected by the polymerase when bicistronic or polycistronic mRNAs are transcribed, as well as during genome replication

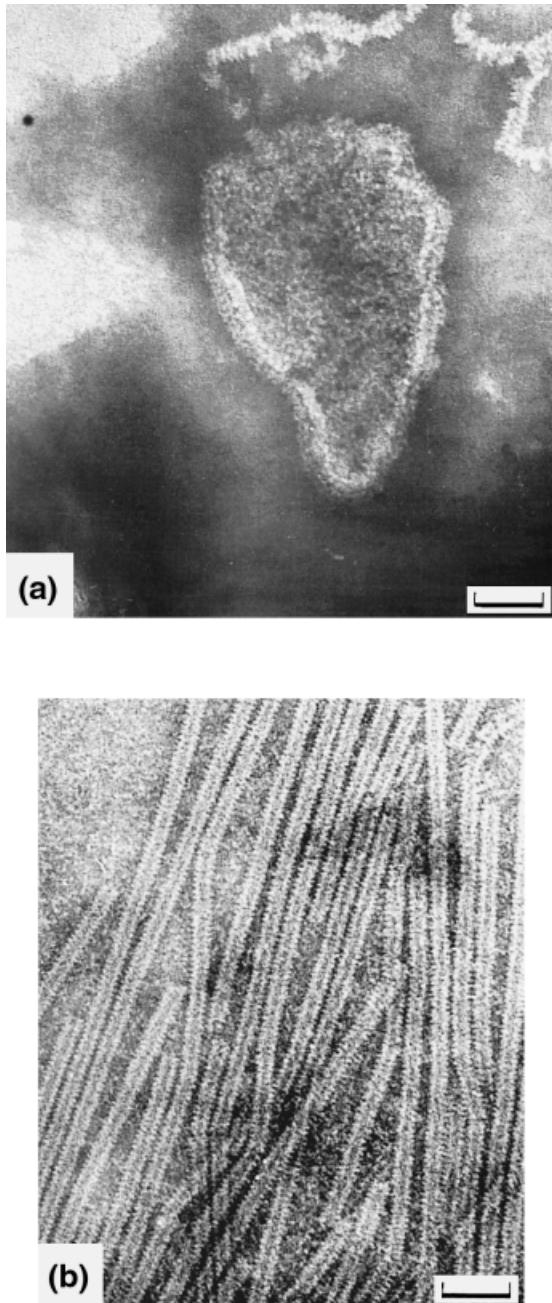

Figure 11.2 Electron micrographs of (a) the measles virion (bar = 50 nm) and (b) purified MV nucleocapsids (bar = 50 nm). Both are negatively stained with phosphotungstic acid. (Reproduced with permission from Meadeley, C.R. (1973) *Virus Morphology*. Churchill Livingstone, Edinburgh)

ters used for viral transcription and/or replication. The genomic RNA molecule is entirely complexed with N protein with one N molecule covering six nucleotides. This is thought to be the reason why only viral genomes whose number of nucleotides is a multimer of six are efficiently replicated by the viral polymerase. Within the 3' leader sequence, transcription of the viral monocistronic mRNAs from the encapsidated genome is initiated. The coding regions of the viral genome are separated by conserved intergenic regions which consist of a polyadenylation signal at the 3' end of each gene, a conserved trinucleotide (CUU, except for CGU at the H/L gene boundary) and a reinitiation signal for the distal gene (Figure 11.1c). From the P gene, three non-structural proteins, C (20 kDa), V (46 kDa) and R (46 kDa) are expressed. Whereas the genetic information for the C protein is encoded by a separate reading frame (Bellini *et al.*, 1985), V protein can only be translated from edited P mRNAs where a G residue not encoded by the viral genome has been cotranscriptionally inserted at particular sites. It thus shares a common N-terminal domain with P, while a zinc finger-like domain is present on the C-terminus of V. About 50% (to yield V) and 1.5% (to yield R) of the P mRNAs are edited, and it has been established that editing is an intrinsic activity of the MV polymerase. This is because P mRNAs, once synthesized, are not edited, and editing of P gene transcripts is not performed by heterologous polymerases such as that of *Vaccinia virus*. At the M–F gene boundary a GC-rich region of about 1 kb in length spans the 3' end of the M gene and the 5' end of the F gene. Several open reading frames have been predicted for this region which could only be accessed by translation from a rare bicistronic transcript by ribosomal reinitiation. None of the putatively encoded proteins has yet been detected in infected cells.

MV Protein Functions

Viral RNP and Non-structural Proteins

The fully encapsidated MV genomic RNA serves as a unique target for the viral polymerase to initiate transcription and replication. The N protein is phosphorylated and acts to condense the viral genomic and antigenomic RNAs into a smaller, more stable and more readily packaged form. This

gives the nucleocapsid its helical form and its herring-bone appearance in the electron micrograph (EM) (Figure 11.2b). When expressed in the absence of viral RNA, N proteins aggregate into nuclear and cytoplasmic nucleocapsid-like structures which are thought to contain encapsidated cellular RNAs. It is the formation of high-affinity protein complexes with the phosphorylated P protein by which self-aggregation of N proteins as well as encapsidation of cellular RNAs are prevented during replication of the viral genome. Both C-terminal and N-terminal domains of P protein are involved in N-P complex formation, while another domain within the P protein has been shown to be essential for its dimerization. Equally important for both transcription and replication, stable complexes between P and L have to be formed, and apparently L protein is stabilized by this interaction. Moreover, P is thought to act as a transactivator regulating L protein functions. The L protein is a multifunctional RNP-specific RNA polymerase producing mRNAs, replicative intermediates and progeny viral genomic RNAs. Capping, methylation, editing and polyadenylation are thought to be mediated by the polymerase protein, in addition to initiating, elongating and terminating ribonucleotide polymerization. Active sites within the protein have not yet been determined, however, conserved motifs have been identified which suggest a linear arrangement of the functional domains. The non-structural proteins C, V and R are expressed in the cytoplasm of infected cells with no association with the virion structure. Their role in MV replication has not been defined. With the availability of the recombinant MV cDNA, viruses have been constructed that are defective in both V and C protein functions. Deletion of either of these gene products apparently did not affect the capacity of the recombinant viruses to replicate in tissue culture (Radecke and Billeter 1996; Schneider *et al.*, 1997).

Envelope Proteins

The RNP core structure is enclosed by a lipid envelope which contains two proteins on its external surface, the haemagglutinin (H) and the fusion (F) protein that are organized as functional complexes and constitute the spikes observed in the EM. The H protein mediates binding of the virus to receptors on the surface of the target cells, while the F protein causes the virus envelope to fuse with the cell, thus

delivering the RNP core into the cytoplasm. Both H and F are glycoproteins and, after infection, it is to these polypeptides that neutralizing antibodies are raised. These proteins are protease-sensitive, as virions appear smooth under the EM following protease treatment. Both types of spikes can be isolated following gentle detergent lysis of the virion, although F tends to remain strongly associated with cellular actin. Both spikes have the tendency to aggregate; this is presumably mediated by the hydrophobic tail of each molecule which normally serves to anchor the spike in the lipid bilayer.

The H protein can be isolated as a tetrameric complex from the cell membrane and its ability to agglutinate red blood cells from sheep and monkeys, but not humans, has long been recognized. Glycosylation sites are bunched within a region of 70 amino acids, and glycosylation has been shown to be essential for haemadsorption, probably by stabilizing the highly complex tertiary structure of the protein. The strict structural constraints of this protein have so far prevented the identification of domains essential for interaction with the identified MV receptor complex, which consists of CD46 physically associated with moesin. Both proteins reveal a wide tissue distribution *in vivo*, and it is of note that CD46 is only expressed on monkey but not on human erythrocytes. H protein most probably serves a dual function: (1) in mediating attachment to CD46; and (2) with certain MV strains, in subsequent downregulation of CD46 from the cell surface. Amino acids essentially involved in the latter biological property have recently been identified. In addition, as revealed by transfection experiments, H exerts a helper function in F-mediated membrane fusion, probably by directing the fusion domain into the optimal distance to the target cell membrane and stabilizing the interaction.

Synthesized as a precursor protein (F_0), F protein is cleaved in the Golgi compartment by subtilisin-like proteases to yield two disulphide-linked subunits, F_1 and F_2 , a structure common to many virus proteins with membrane fusion activity. Glycosylation of the F_0 precursor is an essential prerequisite for cleavage, and it is only the F_2 subunit that contains all the potential N-glycosylation sites. The N-terminal domain of the F_1 subunit, also called the fusion domain, is highly conserved amongst the paramyxoviruses and is highly fusogenic *in vitro*. There are still only theoretical explanations as to why the fusogenic N-terminus of

the F_1 subunit fails to induce membrane fusion during intracellular transport. Most likely, the fusogenic domain is masked during this process by intramolecular folding to a distal domain within the F_1 protein. The fully processed $F_{1,2}$ protein is incorporated into the cell membrane as an oligomer. In the intact virion the active site of each protein is presumably carried at the tip of the spike and orientated outwards, away from the hydrophobic tail and towards any possible target cell.

The M protein is thought to interact with the viral RNP and with the plasma membrane, in which the glycoproteins are inserted to stabilize the virion structure. Recombinant MVs carrying deletions of major parts of the M gene were found to bud highly inefficiently, thus supporting the initial suggestions that this protein might be essential in this process. A physical interaction between MV M and other viral structural proteins has not yet been demonstrated. The generation of a recombinant MV defective for the expression of the MV glycoproteins (and expressing instead the glycoprotein of vesicular stomatitis virus) revealed that the presence of the MV glycoproteins was required for packaging the M protein into mature budding virions, thus indicating that either F or H, or both, would at least transiently have to interact with M protein.

Replication Cycle

MV Receptor Usage and Tropism

One of the most important parameters determining viral tropism is the availability of specific receptors on the surface of susceptible target cells that allow viral attachment and penetration. MV is highly species specific in that it does not naturally replicate in non-primate hosts. *In vivo* it reveals a pronounced tropism for cells of the haematopoietic lineage, but, at later stages can replicate productively in a variety of cell types, as it does in tissue culture. Thus, the receptor would be expected to be expressed by most human cells both *in vivo* and *in vitro*. This is in fact the case for the two major components of the MV receptor complex so far identified (Griffin and Bellini, 1996): CD46 (MCP; membrane cofactor protein), a member of the 'regulators of complement' (RCA) gene family, and moesin (membrane organizing external spike protein), which is tightly associated with CD46. Several

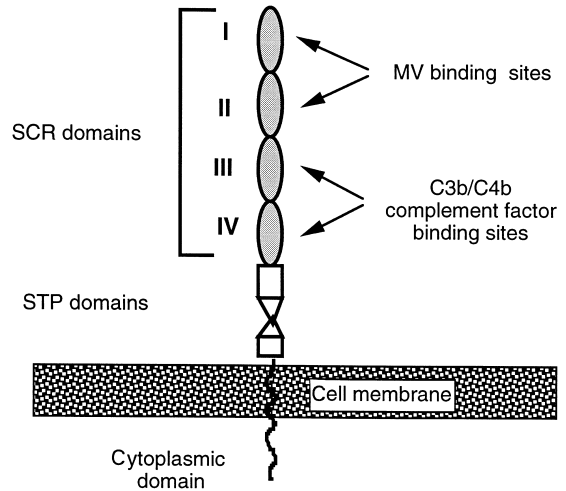

Figure 11.3 CD46 (MCP, membrane cofactor protein), the major protein receptor for MV strain Edmonston. MV-binding sites are located within the short consensus repeat (SCR) domains I and II, whereas complement components C3b/C4b bind to SCR III and IV, respectively. Proximal to the transmembrane domain, oligosaccharide-rich serin/threonine/proline (STP) domains are located.

isoforms of CD46 (due to alternative splicing of a precursor mRNA) are expressed in a tissue-specific manner and all of them can support MV uptake. CD46 contains four repetitive conserved domains, of which the two most distal from the cell membrane have been found to be essential for binding MV or MV-H protein. The molecule's physiological ligand(s), complement components C3b/C4b, bind to other domains located proximal to the membrane (Figure 11.3). As a member of the RCA gene family, CD46 is essentially involved in protecting uninfected cells from lysis by activated complement by recruiting the C3b/C4b components, rendering them accessible to degradation by serum proteases and thus interfering with the formation of membrane attack complexes. It is considered of pathogenic importance that CD46 is down-regulated from the surface of infected cells or following interaction with MV-H protein, as these cells are significantly less protected against complement mediated lysis *in vitro* (Schneider-Schaulies *et al.*, 1995). Most strikingly, however, the property to downregulate CD46 is MV strain dependent since MV strains, predominantly those which have been exclusively isolated and passaged on lymphocytes,

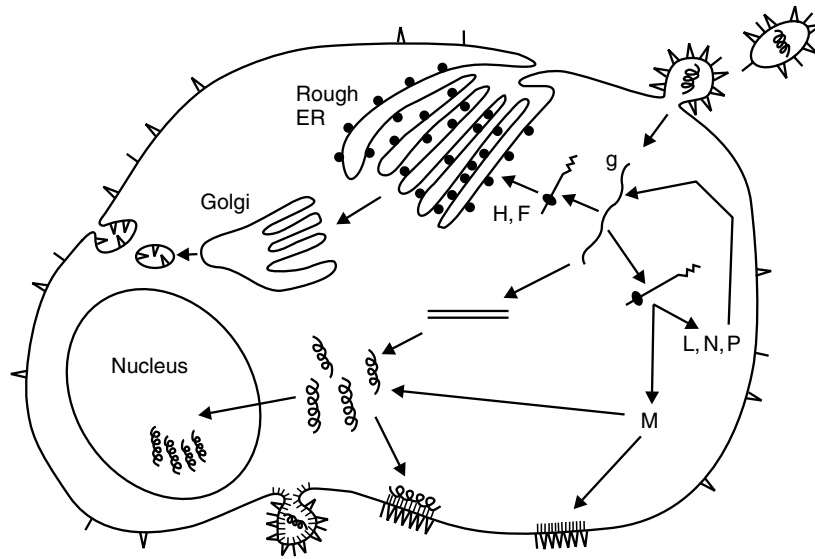

Figure 11.4 The events occurring in measles virus replication

do not reveal this phenotype. It is possible that, when depleted of CD46-mediated protection, MV-infected cells may be eliminated earlier *in vivo*. As all of the MV vaccine strains downregulate CD46, this particular biological property may be considered to be an attenuation marker.

Expression of CD46 is not the only determinant of MV tropism. Stable expression of human CD46 does not confer susceptibility to MV infection in many mouse cells and in CD46 transgenic animals. Rodent brain cells support MV replication both *in vivo*, after experimental infection, and in tissue culture, although they do not express CD46. Thus, additional or alternative receptors, as well as so far uncharacterized intracellular factors, also essentially determine MV tropism.

Intracellular Replication

The time taken for MV replication in a suitable host cell is highly variable and becomes shorter as the virus adapts to growth *in vitro*. For instance, the Edmonston strain replicates well in Vero cells, a permanent cell line derived from the kidney of green monkeys. Growth is complete within 6–8 hours and is accompanied by effective inhibition of host cell macromolecular synthesis. However, other strains, particularly freshly derived isolates, grow more slowly and replication times of 7–15 days are not uncommon. Such viruses often have very little in-

hibitory effect on the biosynthesis of the host cell. The origin and activation stage of the host cells also influence the efficiency of MV replication. It has, for instance, been shown that productive MV infection in primary lymphocytes only occurs if the cells are activated, and does not generally occur in most rodent cells even after host cell penetration. Intracellular factors determining MV susceptibility have not yet been defined.

MV replication is confined to the cytoplasmic compartment. Following delivery of the viral RNP complex into the cytoplasm of a susceptible host cell, viral transcription is initiated after specific attachment of the polymerase complex to the promoter located within the 3' end of the genome and progresses to the 5' end by transcribing mono- and bicistronic mRNAs (Figure 11.4). At each gene boundary, the polymerase complex resumes transcription of the distal gene or, controlled by unknown factors, leaves the template to reinitiate at the promoter region. As a consequence, a polar gradient is established for the frequency of viral mRNAs, with the N-specific mRNA being the most abundant and the L-specific mRNA the least represented (Figure 11.1b). At the 3' end of each gene, poly(A) tracts are added to the mRNA transcripts, most probably by a polymerase stuttering mechanism at the termination signals (Figure 11.1c). This stuttering again reflects the RNA editing activity of the viral polymerase and the introduction of non-

templated nucleotides in primary transcripts. In addition, bi- and polycistronic polyadenylated transcripts spanning two or more adjacent genes are produced. In the replication mode, the polymerase complex has to read through the intergenic boundaries to yield a positive copy of the entire viral genome, the replicative intermediate, which is about 100-fold less abundant than that of negative polarity. It is not known how the polymerase complex decides whether to interrupt transcription at the gene boundaries and polyadenylate the nascent transcripts or to read through and continue transcription to full genomic length. Transcripts of positive polarity containing the encapsidation signal at their 5' end joined to the N gene sequence are thought to be indicative of replication of the anti-genome. Replication of, but not primary transcription from, viral genomic RNA is dependent on protein synthesis, and it is thought that the switch to the replication mode is determined by the accumulation of levels of N protein that has to encapsidate the nascent genome and may act as an antiterminating protein.

The viral mRNAs direct the synthesis of viral proteins by host ribosomes. Those encoding the glycoproteins F and H become membrane bound in the rough endoplasmic reticulum. Protein products are translocated and modified through the Golgi apparatus (acquisition of *N*-linked glycosylation and proteolytic cleavage of the F₀ protein) and finally inserted into the plasma membrane. Progeny RNA interacts with N protein to form the nucleocapsid, and P and L proteins bind to these structures in the perinuclear area. Late in infection, nucleocapsids may also enter the cellular nucleus. M protein combines with some of the cytoplasmic nucleocapsids but also complexes with the plasma membrane and draws together the dispersed virus glycoproteins. It is quite possible that M protein also interacts with cytoskeletal components during this process as well as during intracellular transport of viral RNPs. Progeny nucleocapsid structures line up beneath these modified areas of membrane and are pinched off in the budding process.

The mechanism of budding is unclear, but the ability of M to aggregate in a crystalline array could confer upon it the capacity to distort the membrane into an outward-facing bulge, and ultimately to bud off the nucleocapsid inside a small vesicular structure—the new virion (Figure 11.4). M is thought to act as a trigger in this process, and lack of this

protein and possibly of glycoproteins is considered to be crucial in the pathogenesis of subacute sclerosing panencephalitis (SSPE).

During the replication process the large amount of glycoprotein inserted into the cell membrane causes it to develop the capacity to haemadsorb, while the F protein promotes fusion with adjacent cells. Multinucleate giant cells are thus formed which are pathognomonic for measles infection. This fusion kills the cells more rapidly than the virus, and if it is prevented the cells survive longer and yields of virus are increased.

BIOLOGICAL PROPERTIES OF MV

Stability

The structure of the virion explains much of the early data concerning the stability of the virus. The particle is dependent upon the integrity of the envelope for infectivity and is inactivated by any procedure which disrupts this structure. Hence the virus is sensitive to detergents or other lipid solvents such as acetone or ether. Particles are acid labile and inactivated below pH 4.5, although they remain infective in the range pH 5–9. The virus is also thermolabile. It may remain infective for 2 weeks at 4°C, but it is completely inactivated after 30 minutes at 56°C. At 37°C it has a half-life of 2 hours. Thermolability is probably due to an effect on the internal structure of the particle, since haemagglutinin is relatively temperature resistant. Virus can be stored for prolonged periods at –70°C and also freeze-dries well. These properties have important consequences for the transport and storage of vaccine.

Haemagglutinin

Unlike other members of the morbilliviruses, MV displays haemagglutination activity. This is easily demonstrated using monkey erythrocytes from the rhesus, patas and vervet monkey and the baboon. Human erythrocytes are not agglutinated. The virus H protein acts as a means of attachment to susceptible cells. Consequently, the ability to cross-link erythrocytes, which do not support virus replication, represents an unnatural process in virus

multiplication. Thus the inability to agglutinate erythrocytes from the primary host, which is based on the lack of the major MV receptor component CD46 on these cells, is not surprising. Morbilliviruses are not thought to reveal neuraminidase activity and there is no evidence that they attach to receptors containing sialic acid. Consequently, once attached to a red blood cell, MV does not re-elute rapidly.

H protein inserted into any membranous structure is active in the haemagglutination test (HA). Virus particles separated by isopycnic centrifugation have a buoyant density of 1.23 g ml^{-1} , and HA activity is detected in this area of the gradient. A large amount of haemagglutinating material is also found in the upper regions of the gradient (termed 'light haemagglutinin'), which probably represents H protein inserted into empty membranous fragments of the infected cell, or defective virus particles. Haemagglutinating activity in this fraction can exceed that associated with the intact particles. It is of note, however, that some recent MV wild-type strains have very low haemagglutination activity, which may be caused by the presence of an additional *N*-linked glycosylation site within their H proteins. Alternatively, the recent finding that some wild-type strains only bind poorly to CD46 suggests the use of an alternative MV receptor.

H is the major immunogen of the virus, and antibodies directed against this polypeptide have both haemagglutination-inhibiting (HI) and virus-neutralizing (NT) activities. This is presumably accomplished by blocking the attachment of virus to target cells. However, these antibodies cannot prevent the progressive cell-to-cell spread of the virus mediated by the F protein. The function of H as the major viral attachment protein to host cell receptor(s) has already been outlined (see above), as has the property of H proteins from certain MV strains to modulate the expression of CD46. This latter modulation has been shown to occur after mere surface interaction between MV H protein and CD46, and is thus also observed independent of infection. Although not defined so far, this process is thought to involve membrane signalling, as it has also been found that cross-linking of CD46 by various compounds including MV particles leads to an inhibition of interleukin (IL)-12 synthesis in monocyte/macrophages in tissue culture.

Haemolysis

The ability to lyse red blood cells once the virus has bound is mediated by the viral F protein. This ability is also artificial in the same sense as haemagglutination, since the F protein is not normally called upon to lyse a target cell before productive infection is accomplished. Nevertheless, haemolysis provides a convenient measure of F protein activity which is more sensitive to both pH and temperature than haemagglutination. Optimum temperature for haemolysis is 37°C and optimum pH is 7.4. The ability of the paramyxoviruses to fuse at neutral pH accounts for the characteristic cytopathic effect (CPE) induced by these viruses—the formation of giant cells.

Proteolytic activation of the F protein is vital for its fusion activity; although uncleaved molecules can be inserted into mature virus particles, these have lost the ability to fuse with target cells and are therefore not infectious. The mechanism of F protein activity is not understood. Most likely, interaction of H protein with its receptor triggers a structural rearrangement of the F protein that allows insertion of its fusion domain into the cell membrane. This is also thought to have a destabilizing effect on the local structure of the envelope. The importance of the fusion domain in this process is underlined by the fact that synthetic peptides with similarity to this region efficiently impair cell fusion. The requirement for F protein cleavage could be interpreted as necessary to permit the free movement of the two chains during the conformational change. Antibodies directed against the F protein are required for effective containment of virus infection because local infection can be maintained by cell to cell fusion.

EPIDEMIOLOGY AND RELATEDNESS OF DIFFERENT VIRUS ISOLATES

The efficient spread of the virus is mediated by aerosol droplets and respiratory secretions, which can remain infectious for several hours. The disease incidence in the northern hemisphere tends to rise in winter and spring when lowered relative humidity would favour this form of transmission. In equatorial regions epidemics of measles are less marked but can occur in the hot, dry seasons. Acquisition of

the infection is via the upper respiratory tract, the nose and, possibly, the conjunctivae. Virus is also shed in the urine but this is unlikely to be an important means of transmission.

The spread of measles has been used as a convenient example to illustrate the principles of epidemiology, and it has been calculated that any community of less than 500 000 is unlikely to have a high enough birth rate to supply the number of susceptible children required for the continuous maintenance of the virus in the population. In fact, the complete elimination of measles from isolated groups has been documented. Such communities remain free of the disease until it is reintroduced from outside, and susceptible individuals are once more at risk. Measles often leads to a more serious disease in such communities experiencing the illness for the first time because all age groups are susceptible to the infection. In general, measles mortality is highest in children under 2 years of age and in adults. Death from uncomplicated measles is rare in the developed world, but the introduction of the virus to the Fiji Islands in 1875 resulted in an epidemic with a fatality rate of 20–25%, and introduction into Greenland in 1951 produced an epidemic which infected 100% of the susceptible population and resulted in a death rate of 18 per 1000.

MV isolates have been obtained from many different locations and from patients with different clinical conditions. Much effort has been invested in attempts to distinguish between these viruses and, in particular, to identify any strains which might be predisposed toward the production of encephalitis or SSPE. Conventional serological techniques applying polyclonal antibodies have, so far, failed to demonstrate any significant differences. Thus infection by any one MV confers immunity to them all.

MV is monotypic in nature, i.e. only a single serotype of the virus has been described. Antigenic differences as observed with monoclonal antibodies between vaccine and wild-type viruses need further study, as it is not clear how much this affects the ability of wild-type strains to replicate and be transmitted from persons with waning titres of immunity generated by vaccination with a different genotype. The monotypic nature of MV in serological terms has masked the existence of a set of genotypes which accumulate mutations continuously. During the recent past, molecular epidemiology of MV has been intensively studied. This has been undertaken to reveal whether there are MV strains with different

pathogenic potential (lymphotropism and neurovirulence, the latter more likely to cause SSPE), or to monitor potential antigenic drift in wild-type MV strains that may impair the protective effect of the current vaccine. Moreover, in populations where mass vaccination campaigns have been undertaken it is important to define whether any single measles case would be due to an imported virus or represent a still inadequate vaccine coverage or vaccine failure. Thus, in 1995, 60% of the 309 cases of measles reported in the United States were either directly imported or were found to be directly linked to an imported case by routine investigation or molecular epidemiology methods (Rota *et al.*, 1992).

Sequence analysis of vaccine and wild-type MV strains as well as SSPE isolates have enabled these various MVs to be classified into lineage groups (Table 11.1).

The sequence of the C-terminal 151 amino acids of the N protein has now been analysed in 46 strains of MV. It shows that there is up to 7.2% divergence in the coding sequence and 10.6% divergence in the amino acid sequence between the most unrelated strains in this region. MV strains fall into six or seven different genotypes some of which are extinct (i.e. have not been isolated recently) or others which are still cocirculating in the human population. In this respect, MV does not differ from other paramyxoviruses such as *Human respiratory syncytial virus*, *Human parainfluenza virus type 3* and *Mumps virus*. The vaccine strains widely differ from the wild-type isolates, and SSPE-derived sequences were much more similar to those seen in wild-type viruses. Based on these sequence similarities, it was even possible to identify wild-type MVs that had circulated in a given population as likely infectious agents found later in SSPE brain material. These findings resulted in two important conclusions: firstly, SSPE develops after infection with a wild-type MV and not following vaccination, and secondly, circulating wild-type viruses and not particular neurotropic strains initially infect the CNS. So far, evidence indicates that measles is an antigenically stable virus and that the development of complications is not determined solely by the virus. Susceptibility of the host, age and immune status at the time of infection, and possibly other factors, are almost certainly more significant than the invading virus. The biological importance of the fact that all vaccine strains have a genotype substantially differ-

Table 11.1 Distribution of MV strains in lineage groups

	Strain	Year of isolation	Country of isolation	Origin
Group 1	Edmonston	1954	USA	Wild-type
	Edmonston Vacs			Vaccine strains
	Changchun 47	1957	China	Wild-type
	Leningrad	1960	Russia	Wild-type
	Shanghai	1960	China	Wild-type
	CAM	1968	Japan	Wild-type
	Mantooth	1970	USA	SSPE
	Horta-Barbosa	1971	USA	SSPE
Group 2	IP3CA	early 1970s	USA	SSPE
	MF	early 1970s	Europe	SSPE
	Biken	1975	Japan	SSPE
	Case A	mid-1980s	Germany	SSPE
	Case K	mid-1980s	Germany	SSPE
	Yamagata	late-1980s	Japan	SSPE
Group 3	Woodfolk	early 1970s	USA	Wild-type
	Braxator	1972	Germany	Measles encephalitis
	CM	1976	USA	Wild-type
	Case C	1979	USA	MIBE
Group 4	JM	late 1970s	USA	Wild-type
	Case B	mid-1980s	Austria	SSPE
	WTF	1990	Germany	Wild-type
	BIL	1991	Holland	Wild-type
	DL	1992	Germany	Wild-type
	LB	1993	Germany	Wild-type
Group 5	MV0/MVP	1974	UK	Wild-type
	S33	1983	UK	SSPE
	Boston/BW83	1985	USA	Wild-type
	MCI	1984	USA	Wild-type
	S81	1986	UK	SSPE
	SE/CL	1988	UK	Wild-type
	TT	1990	UK	Kawasaki disease
	Chicago-1	1989	USA	Wild-type
	SND	1989	USA	Wild-type
	Chicago-2	1989	USA	Wild-type
Group 6	Y22/Y24	1983	Cameroon	Wild-type
	R118	1984	Gabon	Wild-type

Based on molecular epidemiologic analyses, MV strains group into six lineages (data from Rima *et al.* in ter Meulen and Billeter (1995)). SSPE, subacute sclerosing panencephalitis; MIBE, measles inclusion body encephalitis; the TT strain has accidentally been isolated from a case with Kawasaki disease.

ent from the currently cocirculating wild-type viruses is unclear. There is, however, no evidence to suggest that the currently used vaccines are not able to control MV infection with viruses of differing genotypes.

CLINICAL MANIFESTATIONS

Acute Measles

Measles was an inevitable disease of childhood prior to the vaccine era. It has been studied in detail and the clinical features are well documented. The course of acute measles is illustrated diagrammatically in Figure 11.5. MV first gains entry into the

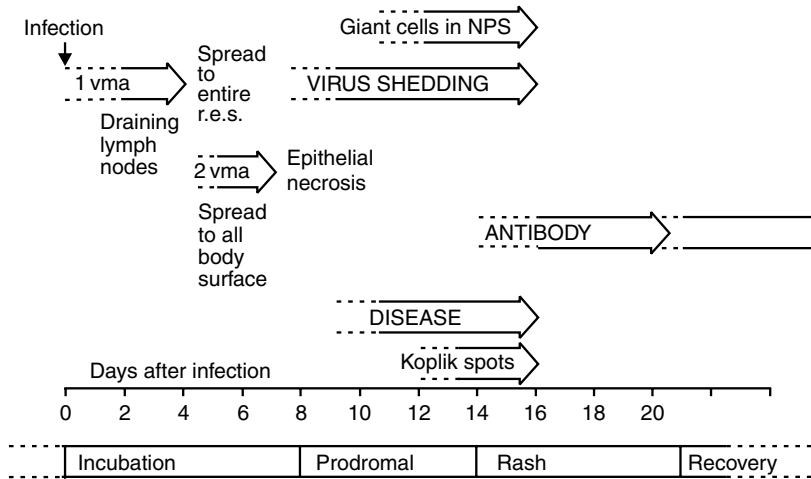

Figure 11.5 The course of clinical measles. The events occurring in the spread of the virus within the body are shown in lower case lettering. As the virus spreads by primary and secondary viraemia (vma) from the lymph node to the entire reticuloendothelial system (r.e.s.) and finally to all body surfaces, epithelial cell necrosis occurs and disease is produced. The characteristics of the disease are given in upper case lettering

body through the upper respiratory tract or conjunctiva. Replication is assumed to occur at the site of entry. The first sign of infection is normally virus replication in the draining lymph nodes and destruction of lymphoid tissue. The virus then spreads to the rest of the reticuloendothelial system and respiratory tract through the blood (primary viraemia). Giant cells containing inclusion bodies (Warthin–Finkeldy cells) are formed in lymphoid tissue and also on the epithelial surfaces of the trachea and bronchi. About 5 days after the initial infection the virus overflows from the compartments in which it has previously been replicating, to infect the skin and viscera, kidney and bladder (secondary viraemia). Giant cells are formed in all infected tissues. Unlike other viruses, measles infection is characterized by lymphoid hyperplasia and inflammatory mononuclear cell infiltrates in all infected organs.

After 10–11 days incubation the patient enters the prodromal phase which lasts from 2 to 4 days. The initial symptoms consist of fever, malaise, sneezing, rhinitis, congestion, conjunctivitis and cough. These symptoms increase over the next days and are quite troublesome. At the beginning of the prodromal stage, a transient rash may develop, which has an urticarial or macular appearance, but disappears prior to the onset of the typical exanthem. At this time giant cells are present in the sputum, nasopharyngeal secretions and urinary sedi-

ment cells. Virus is present in blood and secretions, and the patient is highly infectious. During this period Koplik's spots, the pathognomonic enanthem of measles, appear on the buccal and lower labial mucosa opposite the lower molars. These raised spots with white centers are characteristic of measles and begin to fade some 2–4 days after the onset of the prodromal phase as the rash develops.

The distinctive maculopapular rash appears about 14 days after exposure and starts behind the ears and on the forehead. From there the exanthem spreads within 3 days and involves the face, neck, trunk, and upper and lower extremities. Once the entire body is covered the rash fades on the 3rd or 4th day and a brownish discoloration occurs, sometimes accompanied by a fine desquamation. Histologically, the rash is characterized by vascular congestion, oedema, epithelial necrosis and round cell infiltrates. Once the exanthem has reached its height, the fever usually falls and the conjunctivitis as well as the respiratory symptoms begin to subside. Antibody titres rise and virus shedding decreases from this point. Normally, the patient shows a rapid improvement. Continuation of clinical symptoms of the respiratory tract or fever suggests complications.

Modified Measles

This disease occurs in partially immunized children. They may be infants with residual maternal antibodies or individuals who have received immune serum globulin for protection. Occasionally, this infection has also been seen in the course of live vaccine failure. In general, the illness is mild and follows the regular sequence of events seen in acute measles but with a very reduced symptomatology.

Atypical Measles

This form of a measles is established after incomplete measles vaccination prior to the exposure to natural MV. The majority of reported cases received either several doses of inactivated vaccine or a combination of inactivated vaccine followed by attenuated live vaccine. After an incubation period of about 7–14 days, high fever with headache, abdominal pain and myalgia characterize the sudden onset of the disease. In addition, a dry cough and a pleuritic chest pain are common prior to the rash. In contrast to typical measles, the exanthem develops on the distal extremities and spreads. The rash itself is initially erythematous and maculopapular, but can later be purpuric, vesicular or urticarial. Frequently, oedema of the extremities develop. It is noteworthy that the exanthem involves the palms and soles, with a prominent appearance on the wrists and ankles. The majority of cases develop a pneumonia with a lobular or segmental appearance accompanied by pleural effusion resulting in respiratory distress with dyspnoea. Recovery from the respiratory symptoms is rather slow, and pulmonary lesions can sometimes still be seen on X-ray months after onset of the disease. Marked hepatosplenomegaly, hyperaesthesia, numbness or paraesthesia are occasionally found. The pathogenesis of this disease is still unknown. At the onset, patients may or may not have low antimeasles antibody titres, which rise dramatically during the clinical disease to amounts not seen in acute measles. So far, MV has not been isolated from patients with atypical measles, probably due to pre-existing antibodies, which, however, cannot prevent infection by natural measles. Immunological studies suggest that these patients lack antibodies to measles virus F protein and therefore cannot block virus spread

occurring by cell fusion. It is believed that the F protein of killed measles vaccine is no longer immunogenic as a result of the inactivation procedure.

Complications of Measles Infection

Complications of acute measles are relatively rare, and result mainly from opportunistic secondary infection of necrotic surfaces such as those in the respiratory tract. Bacteria and other viruses can invade to cause pneumonia or other complications such as otitis media and bronchitis. The most severe complications caused directly by MV are giant cell pneumonia and subacute measles encephalitis, both of which occur in the immunocompromised patient, as well as acute measles postinfectious encephalitis (AMPE) and SSPE, in which no underlying susceptibility factor has been identified. Other unusual manifestations which may complicate acute measles are myocarditis, pericarditis, hepatitis, appendicitis, mesenteric lymphadenitis and ileocolitis. If measles infection occurs during pregnancy, spontaneous abortions or stillbirth may occur, as well as an increased rate of low-birthweight infants. Congenital malformations have also been reported.

Giant Cell (Hecht) Pneumonia

In immunocompromised patients, with immunodeficiencies as a result of an immunosuppressive regimen or underlying diseases, MV itself may lead directly to a life-threatening pneumonia characterized by the formation of giant cells, squamous metaplasia of the bronchiolar epithelia and alveolar lung cell proliferation. Measles infection in such patients is thus a serious threat, usually severe with a protracted course and frequently fatal.

Measles Inclusion Body Encephalitis

This condition has been recognized only in immunosuppressed patients. It is most common in children with leukaemia undergoing axial radiation therapy. The incubation period ranges from a few weeks to 6 months, and the patients often present without a rash, since generation of the rash requires an antiviral immune response. Measles inclusion body encephalitis (MIBE) commences with convulsions, mainly myoclonic jerks, and is frequently

confused with SSPE (see below). The seizures are often focal and localized to one site. Other findings include hemiplegia, coma or stupor, depending on the localization of the infectious disease process within the CNS. The disease course is much more rapid than in SSPE and proceeds to death within weeks or a few months. Furthermore, no or only low titres of measles antibodies are detectable in the CSF. This kind of infection is probably best regarded as an opportunistic MV infection.

Acute Measles Postinfectious Encephalitis

Acute encephalitis during the course of measles is a severe complication. It is observed at a frequency of about 1 per 1000–5000 cases of acute measles, although the incidence, the frequency of sequelae and the mortality rate of this CNS disease vary among the available reports. In general, about 15% of cases are fatal, and 20–40% of those who recover are left with lasting neurological sequelae. Encephalitis usually develops when exanthem is still present within a period of 8 days after the onset of measles. Occasionally this CNS complication may occur during the prodromal stage. The encephalitis is characterized by resurgence of fever, headache, seizures, cerebellar ataxia and coma. In common with postinfectious encephalitis induced by other viruses, this condition reveals demyelination, perivascular cuffing, gliosis, and the appearance of fat-laden macrophages near the blood vessel walls. Petechial hemorrhages may be present, and in some cases inclusion bodies have been observed in brain cells. CSF findings in measles encephalitis consist usually of mild pleocytosis and absence of measles antibodies. Long-term sequelae include selective brain damage with retardation, recurrent convulsive seizures, hemiplegia and paraplegia.

Subacute Sclerosing Panencephalitis

SSPE is a rare, fatal, slowly progressing degenerative disease of the brain. It is generally seen in children and young adults and follows measles after an interval of 6–8 years, although SSPE cases have also occurred up to 20–30 years after primary infection. Boys are more likely to develop SSPE than girls but the overall incidence is low (1 case per 10⁶ cases of acute measles). Half the SSPE patients have contracted measles before the age of 2 years, which is a remarkably high figure considering the propor-

tion of actual measles cases in these young children. No unusual features of the acute measles have ever been demonstrated and other factors are presumed important.

The course of SSPE is remarkably variable but seems to start with a generalized intellectual deterioration or psychological disturbance. This may last for weeks or months and may not be recognized as illness until more definite signs appear. These are neurological or motor dysfunctions and may take the form of dyspraxia, generalized convulsions, aphasia, visual disturbances or mild, repetitive simultaneous myoclonic jerks. The invasion of the retina by the virus leads, in 75% of cases, to a chorioretinitis, often affecting the macular area, followed by blindness. Finally the disease proceeds to progressive cerebral degeneration leading to coma and death. The progression of the disease is highly variable, remissions are common and some stages may overlap, so that the progression of symptoms may not be as described. The illness lasts from 1 to 3 years and inevitably leads to death. Much more rapid forms, which lead to death in a matter of months, are also known.

Neuropathological investigations reveal a diffuse encephalitis affecting both the white and the grey matter, characterized by perivascular cuffing and diffuse lymphocytic infiltration. Glial cells may proliferate, and fibrous astrocytes, neurons and oligodendroglial cells contain intranuclear inclusion bodies, described by Cowdry, which may occupy practically the entire nucleus. These have been shown to contain MV nucleocapsid structures. Giant cell formation or membrane changes consistent with virus maturation have not been observed. The neuropathological lesions lead to characteristic EEG changes consisting of periodic high-amplitude slow wave complexes which are synchronous with myoclonic jerks recurring at 3.5–20 second intervals. These periodic complexes (Radermecker) are remarkably stereotyped, in that their form remains identical in any given lead. They are bilateral, usually synchronous and symmetrical. Moreover, they generally consist of two or more delta waves and are biphasic or polyphasic in appearance. The pathophysiology of this abnormal EEG pattern is as yet poorly understood, but most investigators regard these complexes in SSPE as characteristic and even pathognomonic. It is noteworthy that this EEG pattern is variable within the course of the disease and from one patient to another. Moreover,

these typical complexes may disappear as the disease progresses.

Another important and pathognomonic finding is the state of hyperimmunity against MV, as well as the prominent gammaglobulin increase in cerebrospinal fluid (CSF). High measles antibody titres, except against the M protein (see 'Pathogenesis', below), are present both in serum and CSF. The isotypes of MV-specific antibodies found in CSF include IgG, IgA and IgD, and in this compartment the immune response is of restricted heterogeneity. Isoelectric focusing experiments have indicated that it is oligoclonally restricted. This is thought to be due to a restricted number of antibody-secreting cells which have migrated into the CNS and synthesize their antibodies there.

Osteitis Deformans and Otosclerosis

Viral-like nuclear and cytoplasmic inclusions that react with antibodies against paramyxoviruses, including MV, have been detected in multinucleated osteoclasts, in osteoblasts, osteocytes, fibroblasts and lymphomonocytes of patients with Paget's disease (Baslé *et al.*, 1986). The mechanism responsible for viral persistence is still unclear, particularly as the disease persists for many years and remains highly localized, with new lesions rarely if ever developing in previously unaffected bones. As revealed by recent studies, MV N-specific transcripts were successfully amplified from mononuclear cells and osteoclast-like multinucleated cells formed in long-term bone marrow cultures as well as osteoclast precursors and peripheral blood mononuclear cells of patients but not of controls (Reddy *et al.*, 1996). Similarly, by ultrastructural and immunohistochemical studies, MV-like structures and MV antigens and, by reverse transcription-polymerase chain reaction (RT-PCR), MV N-specific transcripts were detected in bone material from patients with otosclerosis, a disease that shares clinical and histopathological findings with Paget's disease (Arnold *et al.*, 1996; McKenna *et al.*, 1996). Since the aetiology of both Paget's disease and otosclerosis is largely unknown, it is unclear whether the observation of MV in bone tissue is of pathogenetic significance or just an epiphenomenon.

PATHOGENESIS OF MEASLES AND ITS COMPLICATIONS

Measles is a remarkable pathogen: it is able to replicate in a variety of tissues, including cells of the immune system. Indeed, its interaction with the immune system is itself responsible for some of the key features of the disease. A delayed hypersensitivity reaction is implicated in the production of the rash, and could also be involved in the tissue damage observed in AMPE. Furthermore, there is evidence to suggest that interaction with the immune system may be responsible for the modification of the disease process observed in SSPE.

MV pathogenesis is not easily assessed in animal models. As yet, only primates have been found permissive for MV following intranasal infection and develop clinically measles, whereas attempts to induce measles-like disease processes in small animals by this route have largely failed. Apparently, MV replication in rodents is impaired due to intracellular restriction, as both rats and mice genetically engineered to express CD46 fail to replicate the virus after peripheral infection. For unknown reasons, only cotton rats (*Sigmodon hispidus*) reveal a certain permissivity, as infectious virus can be reisolated from lung tissue following intranasal infection. Moreover, as with acute measles, experimental infection of these animals is accompanied by a marked immunosuppression (see below). In addition, experimentally induced CNS infections have been described after intracerebral infection with certain MV strains in both mice and rats, and have led to a better understanding of both virological and immunological parameters of MV-induced CNS diseases.

Acute Measles

One of the earliest signs of infection is a pronounced lymphopenia, and a defect in cell-mediated immunity is observed, as demonstrated in tuberculin-positive individuals who become tuberculin negative. These effects are the result of virus interactions with cells of the lymphoid system (see below). After gaining entry to the body the virus exhibits pronounced lymphotropism, and replication is normally detected in the draining lymph nodes rather than at the site of entry. *In vitro*, replication of MV is only

observed in mitogen-activated lymphocytes, whereas monocytes apparently do not support productive replication at all. *In vivo*, the virus remains highly cell associated and can be isolated from lymphocytes in the early stages of infection. Again, this is greatly assisted if the cells are mitogenically stimulated. Only a small proportion of the patient's lymphocytes are infected, and these include B cells and T cells as well as monocytes.

Following extensive replication in the lymphoid tissue, virus is spread through a secondary viraemia, and replication continues in the epithelia of the lung and buccal cavity. The epithelia of the respiratory tract and conjunctiva are relatively thin, with about one or two cell layers. These soon begin to break down, and inflammatory reaction leads to the symptoms observed at the beginning of the prodromal phase: runny nose, conjunctivitis, malaise and fever. The thicker mucosal surfaces of the buccal cavity are then affected and Koplik spots appear about 11 days after infection. The appearance of these spots marks the commencement of a delayed-type hypersensitivity reaction similar to that which gives rise to the rash. The spots fade some 3 days after their appearance as the rash itself develops. The mechanism underlying the production of both the spots and the rash is thought to be the same. Unlike other sites of replication, virus antigen is absent from the lesions themselves. Virus antigen can be detected in the skin, but it is concentrated near blood vessels and in the endothelial cells of the dermal capillaries themselves. The rash is characterized by vascular congestion, oedema, epithelial necrosis and round cell infiltration, but giant cells are absent. Virus replication does not break through the skin and virus is not shed from this surface. The containment of infection in the skin is thought to be due to the development of cytotoxic T cells, which destroy infected tissue, and to interferon production, which acts to promote cellular resistance to infection. The rash itself results from accumulated damage to the vascular walls caused by this delayed-type hypersensitivity reaction, and is thus mostly not observed in the immunosuppressed.

Although antibody titres are normally rising at this stage of the illness, they are not thought to be the major factor in promoting recovery. MV-infected cells are lysed inefficiently by the classic pathway of the complement activation, although more so by the alternative pathway. Furthermore, patients with agammaglobulinaemia handle MV in-

fection normally and recover. However, those with T cell deficiencies do not usually develop the rash and can be severely ill.

MV-induced Immunosuppression

Evidently, measles infection in the immunocompetent host triggers an efficient virus-specific immune response that leads to the clearance of the virus from peripheral blood and the establishment of a lifelong immunity against reinfection. Paradoxically, at the same time a general suppression of responsiveness to other pathogens is established, which was recognized long before the virus was isolated, and which is the major reason for the constantly high morbidity and mortality rate associated worldwide with acute measles. Typically, the patients are highly susceptible to opportunistic infections and reveal a marked lymphopenia affecting both B and T cells. The latter is most likely to result from a general loss of lymphocytes due to viral infection which may initially proceed quite extensively. In addition to lymphocytes, MV-infected monocyte/macrophages have also been found, predominantly at later stages of the disease. Immunosuppression, however, is still observed up to weeks after the onset of the rash, when the lymphocyte counts have returned to normal and MV-infected cells are present with only low frequency or are no longer detectable. Key features of MV-induced immunosuppression are inhibition of delayed-type hypersensitivity responses and a restricted ability of lymphocytes to proliferate in response to recall antigens, as well as allogenic and mitogenic stimulation (Figure 11.6a). As only a few infected cells are usually detected, several hypotheses have been put forward to explain this finding; these include the production of inhibitory factors by infected cells that have not yet been identified (Oldstone and Fujinami, 1982). More recently, it was shown that the interaction of the viral glycoproteins with the surface of uninfected cells may interfere with the production of stimulatory cytokines such as IL-12 by monocyte/macrophages (Karp *et al.*, 1996), or induce, in a dose-dependent manner, a cell cycle arrest in uninfected lymphocytes both *in vitro* and after transfer in cotton rats (Sanchez-Lanier *et al.*, 1988; Schlender *et al.*, 1996; Niewiesk *et al.*, 1997) (Figure 11.6b). Interestingly, professional antigen-presenting cells such as dendritic cells have also been found to impair rather than stimulate activa-

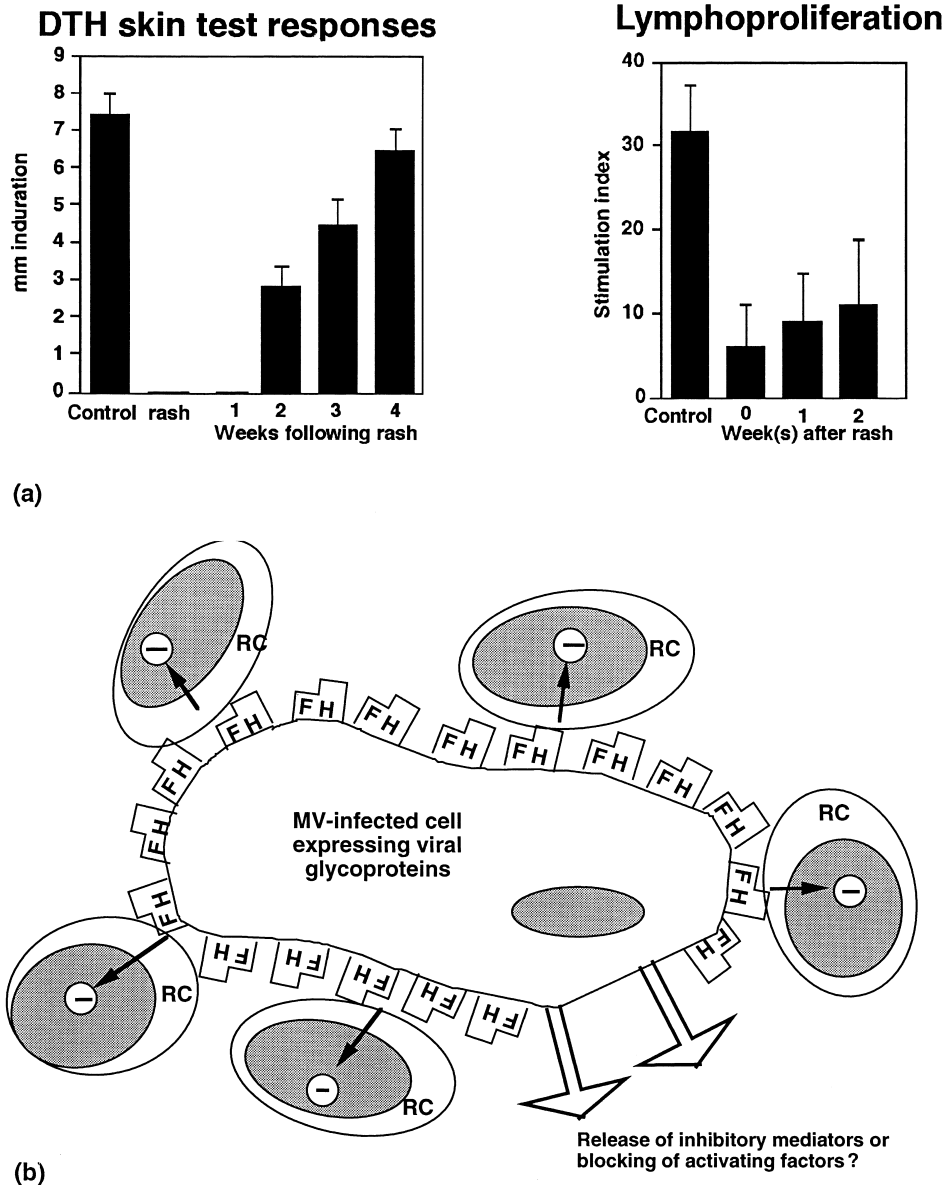

Figure 11.6 (a) In the course of and following measles, both delayed-type hypersensitivity reactions (DTH), as measured by tuberculin test, and *in vitro* proliferative responses of lymphocytes to mitogen stimulation are suppressed (Data from Tamashiro *et al.* (1987) and Hirsch *et al.* (1984)) (b) Illustration of current models to explain MV-induced immunosuppression. Responder cells (RC) are uninfected lymphocytes

tion of T cells *in vitro* once they express viral glycoproteins on their surface (Schnorr *et al.*, 1997). Dendritic cells with functional characteristics of epidermal Langerhans' cells form a continuous network within the epithelial lining of the conductive airways and are the most potent type of antigen-presenting cells for activation of naive and memory T cells once they have homed to the local

lymph nodes. Thus, these MV-infected cells confer a negative rather than a positive signal to lymphocytes in the T cell areas of the lymph node and could play a central role in the induction of a widespread immune suppression. Interestingly, MV-infected follicular dendritic cells have been found in the B cell areas of lymph nodes of experimentally infected rhesus macaques, and generation of sec-

ondary follicles was largely impaired in areas where infected follicular dendritic cells were observed.

Acute Measles Postinfectious Encephalitis

It is likely that CNS involvement, even in uncomplicated measles, is common. Transient abnormality of the EEG is detected in about 50% of patients; headache is common and CSF pleocytosis is also observed. The question of whether and how MV may reach the CNS in the course of the acute infection is still a matter of controversy. MV is highly lymphotropic and could be carried into the CNS even in cases where encephalitis has not been recognized. However, only exceptionally can MV be isolated from the brain tissue of AMPE patients. In the majority of cases studied, neither MV antigen nor RNA have been found in the CNS. Therefore, current theories favour an autoimmune reaction as the possible cause of CNS damage, since AMPE patients may exhibit a proliferative T lymphocyte response to basic myelin protein (MBP). In addition, in CSF specimens of such patients MBP was detected as a consequence of myelin breakdown. Such MBP-specific lymphoproliferative responses have not only been seen after measles but also in patients with postinfectious encephalomyelitis following rubella or varicella or after rabies immunization (Johnson and Griffin, 1986). This last disorder is probably the human equivalent of experimental allergic encephalitis (EAE), as such patients received rabies vaccine prepared in brain tissue. Since AMPE is characterized by demyelinating lesions in association with blood vessels as in EAE, it is not surprising that the finding of an MBP-specific lymphoproliferative response in measles infection is considered to be of pathogenetic importance. How MV leads to a T cell-mediated autoimmune response is still unknown. At present, the possibilities of molecular mimicry or a deregulation of autoreactive cells occurring secondary to viral infections of lymphocytes are being considered.

Measles Inclusion Body Encephalitis

As this condition arises in patients with underlying immunodeficiencies, it is not usually accompanied

by intrathecal antibody synthesis, and the un-protected cells develop massive inclusion bodies, consisting of virus nucleocapsids, in both nucleus and cytoplasm. The condition can develop following exposure to measles or develop later. Infectious virus has not been isolated by conventional methods from brain tissue, suggesting defects in replication. This assumption has been supported by immunohistological and molecular biological studies on brain tissue of a case of MIBE. Of the five major structural proteins of MV, only N and P proteins were consistently detected in infected brain cells, whereas the envelope proteins were missing. In contrast, the mRNAs specific for the five viral proteins were detectable in brain-derived total RNA samples by Northern blot analyses, although the mRNAs for the envelope proteins were under-represented in comparison with lytically infected cells. *In vitro*, N and P proteins were efficiently synthesized from their corresponding mRNAs, indicating a restriction of the expression of the MV envelope proteins in MIBE (Baczko *et al.*, 1988). Partially, this restriction has been explained by sequence analyses that revealed a high rate of mutations distributed over the entire MV genome. For the MV M gene, mutations have eliminated the initiation codon, which explains the failure of MV M protein synthesis in infected MIBE brain tissue (Cattaneo *et al.*, 1988). Defects in MV mRNA transcription and envelope protein synthesis apparently do not largely affect the activity of the RNP complex which spreads to different areas of the patient's brain. As infectious virus particles may never be formed due to the restriction of the envelope proteins required for assembly and budding, and giant cell formation has never been observed, the spread is thought to occur by microfusion events.

Subacute Sclerosing Panencephalitis

MV was first implicated in the aetiology of this disease by immune fluorescence in 1967, and this has since been confirmed by electron microscopy, immunoelectron microscopic methods, and finally by the successful rescue of virus by cocultivation techniques (ter Meulen and Hall, 1978; ter Meulen and Carter, 1984). Despite this, the manner in which the persistent infection is first established in the brain and exactly how this leads to the production

of disease are still largely unknown. Recent PCR-based studies even suggested that MV may in fact reach the brain and establish lifelong persistent infections that remain asymptomatic and do not lead to the development of SSPE (Katayama *et al.*, 1995; Nakayama *et al.*, 1995). The virus is thought to gain entry to the CNS during viraemia in acute measles, or by infected lymphocytes, but, once there, replication proceeds only slowly and a widespread encephalitis is not established. It is also not known to what extent virus replication *per se* is responsible for the development of lesions, nor what part is played by the immune system.

Virological Aspects

Important clues have come from the study of MV replication. The virus normally replicates with the production of giant cells and release of infectious progeny. In SSPE, free infectious virus has never been isolated, either from the brain or from CSF, and histopathological examinations have consistently failed to reveal the morphological changes associated with virus maturation (ter Meulen *et al.*, 1983; Schneider-Schaulies and ter Meulen, 1992). As with MIBE, giant cells and thickening of the plasma membrane at points of budding have never been observed, suggesting the absence of viral glycoproteins. Viral nucleocapsids present in the cytoplasm are randomly scattered and show no sign of regular alignment beneath the plasma membrane. As budding viral particles and infectious virus are not detected, the infection may spread slowly, strictly in a cell-associated manner. MV-specific antibodies produced in the CNS are oligoclonal, as opposed to the polyclonal response observed in the serum (Dörries *et al.*, 1988). This suggests that antibody in the CSF is made locally by a much smaller population of lymphocytes which have invaded this compartment in response to antigens present in the CNS. This is further supported by the finding that only MV-specific antibody titres are tremendously elevated, titres against other viruses being normal. In serum specimens, antibodies with specificity to all MV proteins are present, although recognition of the M protein is low or sometimes absent, whereas antibodies in CSF samples generally fail completely to detect M protein.

In SSPE brain sections, only the expression of the MV N and P proteins and not that of the envelope proteins was consistently detected in infected cells

by immunohistochemistry. Molecular biological studies on SSPE brain tissue revealed extensive transcriptional and translational alterations affecting mainly MV M, F and H genes (Carter *et al.*, 1983; Baczko *et al.*, 1986; Liebert *et al.*, 1986; Cattaneo *et al.*, 1986; Sheppard *et al.*, 1986). As in MIBE, the envelope protein-specific mRNAs were only detected at low copy numbers (Cattaneo *et al.*, 1987) and were highly impaired in directing the synthesis of the corresponding gene products *in vitro* (Figure 11.7). Sequence analyses revealed a high rate of mutations located all over the MV genome, although different genes were affected at different levels. The highest number of alterations were found in the M gene, followed by F, H, P and N genes, which were mutated to about the same extent, whereas the L gene was most conserved. Mutations introduced were either point mutations, most probably accumulating due to the infidelity of the viral polymerase, or appeared as clustered transitions which are thought to result from the activity of a cellular enzyme complex that actively modifies viral genetic information. As a result of either of these events, translation of viral mRNAs was completely abolished or led to the synthesis of truncated or unstable MV proteins. These molecular biological data explain the absence of infectious MV particles and the lack of a budding and a cell fusion process in infected SSPE brain tissue, since for these events biologically active MV envelope proteins are required. Although infectious virus is not present in the CNS, virus can occasionally be rescued from brain tissue obtained post mortem by cocultivation (Wechsler and Meissner, 1982). So-called SSPE isolates can be of two different types: cytolytic budding or cell-associated viruses, the latter spreading through the culture with a gradually enlarging area of CPE. In the second type of isolate mRNAs for the MV, envelope proteins are detectable in infected cells, although their function is impaired since these proteins are not synthesized in infected cells or in *in vitro* translation experiments. As revealed by recent sequence analyses, some of the SSPE isolates are likely contaminations and are in fact ordinary laboratory MV strains. It is still unclear whether those which are true SSPE isolates may represent a small subpopulation of replication/maturation competent viruses or revertants that have been selected by the isolation procedure and may not be representative of the dominant virus population in the infected brain.

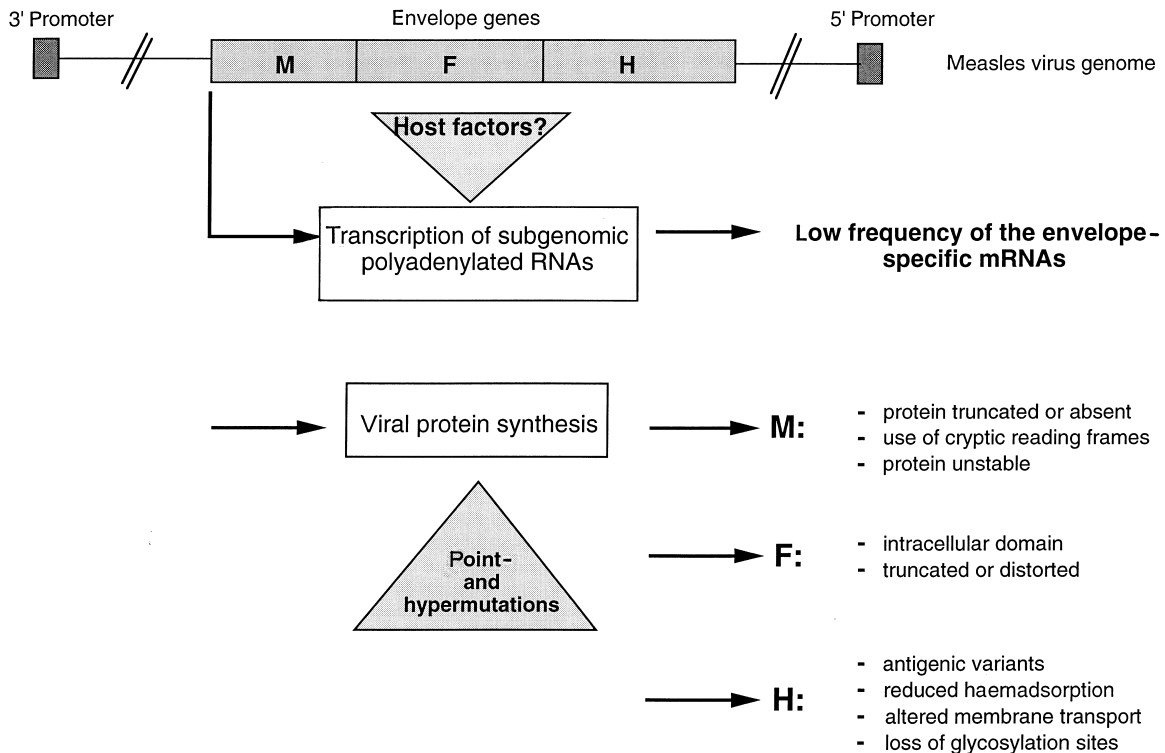

Figure 11.7 Restrictions of MV gene expression found in SSPE brain tissue. MV mRNAs encoding the viral envelope proteins are expressed at low frequency (most probably due to host cell control mechanisms) and, in addition, harbour mutations that prevent the synthesis of functional translation products

These virological and molecular biological findings in SSPE help to explain the absence of MV particles in brain tissue and the failure of the humoral immune response to eliminate infected brain cells. Factors involved in the establishment of persistence by a non-defective MV in brain tissue are largely unknown, since these studies have been carried out on autopsy material. In tissue culture experiments with cells of neural origin, and in brain material of experimentally infected animals evidence has been provided to show that intracellular factors intimately control the efficiency of MV replication (Schneider-Schaulies *et al.*, 1990). This applied particularly to attenuation of viral transcription, as well as to translational control exerted predominantly on MV-specific and not on cellular mRNAs in brain cells *in vitro*. In addition, the cellular enzyme activity actively modifying the primary sequence of viral RNAs has been demonstrated in these cells. Thus, it is a likely assumption that intracellular factors present in brain cells act to slow down viral replication after primary infection, thus

preventing a rapid host cell destruction. Whether these control mechanisms efficiently control the maintenance of the persistent infection or other factors, such as the introduction of mutations into the viral genome, are required has not been resolved.

Immunological Aspects

One of the immunological hallmarks in SSPE is the hyperimmune response to MV antigens, which includes neutralizing antibodies in serum and CSF. Yet this immune response fails to control virus infection. This phenomenon has led to the proposal that measles antibodies may support persistence rather than interfere with it. In tissue culture, MV-specific antibodies act to cross-link viral proteins expressed on the surface of infected cells which subsequently aggregate at the pole of the cell to form so called 'cap-structures'. These caps are internalized and thus removed from the cell surface. During this process, M protein cocaps with the viral glyco-

proteins. Since complement-mediated lysis is of low efficiency in the brain as a result of low complement concentration in this compartment, it is likely that the major effect of antibody in brain tissue would be to promote clearance of antigen from the brain cell surfaces rather than lysis of the infected cells. This process might explain the lack of membrane glycoproteins on the surface of brain cells but cannot explain the lack of intracellular envelope proteins. Yet some evidence has been obtained in tissue culture experiments which suggests that the capping process could interfere with viral protein synthesis. It has been shown that antibody directed against the haemagglutinin of influenza viruses can exert an inhibitory effect on the activity of the viral polymerase. Similar observations have been made in cell lines persistently infected with MV or in MV-infected rats. In the latter, passive transfer of neutralizing monoclonal antibodies directed against the MV H protein led to the development of a subacute MV encephalitis by preventing an acute CNS infection (Liebert *et al.*, 1990). The molecular biological analysis revealed a transcriptional restriction of viral mRNAs. Thus in SSPE the host immune response could contribute to the production of this serious fatal disease.

It is well known that cell-mediated immunity (CMI) is far more significant in the control of MV infection than the humoral immune response. This has led to considerable interest in the CMI response mounted by SSPE patients. In general, no evidence for a general impairment of CMI in these patients was obtained. T cells are present in normal amounts, and lymphoproliferation and interleukin synthesis in response to a variety of antigens are normal. Similarly, skin grafts are rejected in a normal fashion. It is possible that the response to MV antigens is impaired, since anamnestic skin tests with measles antigens are often negative. A disparity of results was obtained by using MV antigens in assays for CMI. Depending on the test system employed and on the potency and purity of the virus antigens used, a minor inhibition of CMI or normal reactions in comparison to controls can be observed in SSPE patients.

DIAGNOSIS

The symptoms of acute measles are so distinctive

that a virus laboratory is seldom called upon to make a diagnosis. As the vaccination programme takes effect, physicians may become less familiar with the disease, and vaccination itself has led to the emergence of atypical forms of measles. Diagnosis of these manifestations may require laboratory work. Furthermore, as more patients are placed on immunosuppressive regimens, the need for diagnosis of MV may well increase. Several procedures are available and are described below.

Microscopy

Direct Examination

Production of multinucleate giant cells with inclusion bodies is pathognomonic for measles during the prodromal phase. Such cells are detectable in the nasopharyngeal secretions (NPS). Clear identification of giant cells is facilitated if the smear is first fixed in formalin and then stained with haematoxylin or eosin. The Cowdry inclusion bodies are then easily discerned.

Fluorescence Microscopy

Both direct and indirect immunofluorescence (IF) have been widely used to stain cells shed in nasal secretions, although it may be necessary to remove antibodies which already coat virus antigens with a low pH buffer. Stained cells include macrophages and ciliated cells as well as giant cells. Urinary sediment cells have also been examined with a high degree of success. IF-positive cells may be shed in the urine from 2 days before to up to 5 days after the appearance of the rash. This method may therefore be more applicable in later stages than examination of NPS specimens. Such cells may also be present in the urine 4–16 days after vaccination with the live vaccine. IF is useful for the diagnosis of measles in the pre-eruptive phase or in children vaccinated with killed vaccine, where rash development is atypical. Immunoperoxidase histochemical stains have also been used, and the use of monoclonal antibodies has improved sensitivity and reliability of virus detection.

Serological Methods

In common with other infections, diagnosis of

measles may be made if antibody titres rise by more than fourfold between the acute and the convalescent phases or if measles-specific IgM is found. Several methods are available for this determination and are also useful for the assessment of immune status. The tests most commonly used are haemagglutination inhibition (HI), neutralization (NT), hemolysin inhibition (HLI), complement fixation (CF) and enzyme-linked immunoassay (ELISA). Of them all, the NT is the most sensitive and specific but it is not very practical and therefore rarely used. HI, HLI, ELISA and CF are more useful in practice, although the decreased sensitivity of the CF test renders it not useful for testing immune status. ELISA tests are usually applied for measles-specific IgG and IgM. Other tests such as gel precipitation are rarely used. In general, titres of 8 or higher are indicative of immunity. In the case of SSPE, it is important that CSF is also tested.

Virus Isolation and Detection of Viral RNA

Both virus isolation and RT-PCR-based detection of viral RNA should be applied only in specific instances, such as suspected infection of the immunosuppressed in the absence of rash when only limited antiviral immunoglobulins might be expected, developing pneumonia without a rash or unexplained encephalitis. Finally, both techniques can be attempted as a means of retrospective diagnosis using tissue obtained post mortem.

RT-PCR analyses using MV N- and/or F-gene specific primers are mostly performed on serum, nasopharyngeal aspirates and urine sediment cells; however, they can also be applied to tissue samples such as brain material. This technique requires an RNA extraction step prior to reverse transcription and subsequent PCR amplification.

In acute measles, virus isolation is difficult and the success rate may be low. Isolation is most likely to be achieved from material (such as throat or conjunctival washings, sputum, urinary sediment cells and lymphocytes) taken during the prodromal phase and is unlikely to succeed once antibody titres have started to rise. Isolation is therefore only usually attempted in unusual cases. For virus isolation, washings and swabs are collected and mixed with buffered salt solution (pH 7.2) containing anti-

biotics. Urinary sediment cells are collected by low-speed sedimentation and treated similarly. MV can be isolated directly from blood but efficiency is increased if lymphocytes are first separated on a ficoll gradient and stimulated with mitogen before use. Samples are then inoculated in triplicate on susceptible tissue cultures, such as primary human embryo kidney (HEK) cells and primary monkey kidney cells. In the latter case, the monkeys should have been serologically tested, since some animals harbour monkey intranuclear inclusion agent (MINIA) which is similar to measles. Continuous cells lines derived from green monkey kidney cells (Vero or CV-1) are also suitable. These are less likely to be successful than primary cell culture. Recently, Epstein-Barr virus-transformed B lymphoblastoid cell lines (B95a, BJAB) were used for MV isolation (Kobune *et al.*, 1990). It was shown that these cells revealed a significantly higher susceptibility to MV present in clinical specimens than Vero cells. Moreover, MV isolated in B95a cells differed in some biological properties from those adapted to Vero cells, suggesting the MV is subject to host cell-mediated selection. It is therefore recommended to include these cell lines in MV isolation attempts. CPE develops usually between 48 hours and 15 days, and consists of either a broad syncytium or a stellate form. Both types reveal inclusion bodies, which may be present in both nucleus and cytoplasm. It is not known what governs the different forms of CPE but the availability of cellular nutrients as well as the type of virus have an effect. Uninoculated identical cultures should also be maintained as controls. If CPE is slow or not clear, it is possible to test whether the cells have acquired the ability to haemadsorb monkey erythrocytes or contain MV antigens or RNA.

Diagnosis of SSPE

The diagnosis of SSPE presents certain problems. Formerly, brain biopsy was performed routinely and tissue thus obtained was examined for inclusion bodies and virus antigen by immunofluorescence. After recognition of the characteristic intrathecal antibody synthesis, determination of measles antibody titres in the CSF may be sufficient with, if necessary, demonstration of MV-specific heterogeneity by isoelectric focusing in combination with

an immunoblot technique (Dörries and ter Meulen, 1984). Virus isolation from SSPE brain tissue is complicated. Expression of virus must be restored by growing cells derived from brain tissue with cells susceptible to MV infection, or fusing them together directly. It is therefore necessary that samples from SSPE brain contain viable cells. As MV replication does only occur within brain cells, and viral particles are not released, MV-specific sequences can generally not be amplified by RT-PCR in CSF samples.

MANAGEMENT

Measles

Measles is an acute self-limiting disease which, in the absence of complications, will run its course without the need for specific intervention. Infection of the undernourished, the immunocompromised or children suffering from chronic debilitating diseases is more serious. Such patients, as well as children of less than 1 year of age and pregnant women, can be protected after exposure by the administration of human antimeasles gammaglobulin (0.25–0.5 ml kg⁻¹). If this is given within the first 3 days of exposure, it is usually effective. The effectiveness is diminished if the globulin is given 4–6 days after exposure, and abolished if more than 6 days have elapsed.

Measles Pneumonia

Respiratory tract infections cause considerable damage to the ciliated epithelium and this may lead to superimposed bacterial infection. In the case of a pneumonia it is sometimes difficult to distinguish between primary viral infections and the superimposed bacterial infection. In any case, treatment with antibiotics is required.

Encephalitis

Treatment of acute measles postinfectious encephalitis is only symptomatic and supportive, and does not differ from any other postinfectious encephalitis. Careful attention to fluid and electrolyte balance

is essential. Seizure control requires anticonvulsive drugs. Application of steroids has not been shown to be beneficial. No specific therapy is known for subacute measles encephalitis.

A variety of approaches to the treatment of SSPE have been attempted. As yet no convincing effects have been demonstrated and almost all cases have proved fatal. Evaluation of the effectiveness of treatment is extremely difficult. First, the course of SSPE is highly variable and spontaneous remissions are common. Secondly, SSPE is a rare disease, and clinical trials are therefore inevitably based on a very small number of patients and interpretation is difficult.

The aim of any therapy must be to prevent the spread of virus within the CNS and to aid the body's immune system to bring about the ultimate elimination of the virus from the body. The disease is extremely difficult to treat because no antiviral drugs which are effective against MV yet exist. Furthermore, access is limited because of the anatomical and physiological peculiarities of the brain. Therefore most attempts at treatment have aimed towards the activation of potentiation of the immune defense in the brain. A possible deficiency in CMI to MV has already been discussed, and the following regimens have been used with no or doubtful effects: removal of blocking factors by complete CSF exchange; potentiation of helper T cell activity; isoprinosine (inosiplex); levamisole (*l*-tetramisole) and interferon treatment. In the case of isoprinosine, it seems likely that treatment may lengthen survival time if given early in the disease. This effect becomes less pronounced if the drug is administered later.

PREVENTION

Since MV has no animal reservoir, it is an obvious target for a controlled campaign aimed at the eradication of the virus (Mitchell and Balfour, 1985). In the United States and Canada, where vaccination of all children is required at or before commencing school, the results have been quite startling. Case reports have fallen by over 99% but eradication has not yet been achieved. In Germany and the UK, where vaccination is not mandatory, distrust of vaccination has led to a lower acceptance rate and less dramatic results have been achieved. In developing

countries, where the consequences of MV infection are most severe, considerable effort has been expended with comparatively little return. Any vaccine used must be safe, as measles is not normally a severe illness, and cheap enough for mass administration. Its effectiveness should also be long lasting. Natural immunity is known to last for at least 65 years in the total absence of restimulation from virus in the environment. In 1781 measles disappeared from the Faroe Islands following an epidemic. It was not reintroduced until 1846. Individuals old enough to have experienced the disease 65 years previously were still protected. This unusual persistence of immunity even in the absence of re-exposure from the environment has suggested that MV may normally persist inside the body, possibly in lymphocytes, and thus restimulate immunity from within.

Inactivated Vaccine

This vaccine was intended for use in young children less than 1 years of age, who are most prone to serious complications. It was therefore considered desirable to avoid the use of a live vaccine. With formalin-killed virus preparation it was found that at least three vaccinations were necessary to elicit a suitable antibody response. Titres were lower than those induced by natural measles and soon waned. This left vaccinees open to virus attack, but the nature of their partial immunity led to serious hypersensitivity reactions to infection and the disease course was modified (see Atypical measles). Most likely, an important epitope was destroyed by the inactivation of the live virus and thus the vaccine could only induce incomplete immunity. Antibody induced by natural measles or live vaccine is protective at much lower levels than that produced in response to the killed vaccine. This suggested that some qualitative difference existed between the two types of antibody. It was shown that killed vaccine failed to induce effective haemolysin-inhibiting antibodies, which *in vivo* prevent virus spread from cell to cell. The problems could perhaps be overcome, but, in view of the rapid decline in induced antibody, live vaccination is now recommended, and individuals previously immunized with the killed vaccine should be reimmunized with the live attenuated strain of virus. Even this procedure is

not without risk and adverse reactions to the live vaccine may be seen in as many as 50% of the revaccinees. A similar phenomenon occurs in the case of live and killed vaccinia virus vaccines where the killed virus lacks an important antigen found only on mature released virus.

Live Vaccine

The first attenuated vaccine strain was the Edmonston B strain produced by serial passage of the virus in human kidney cells, human amnion cells, chick chorioallantoic membrane and, finally, duck embryo cells. This vaccine was administered intramuscularly or subcutaneously 12–18 months after the disappearance of maternal antibodies. It was effective and achieved seroconversion in 95% of recipients, but side-effects of mild measles were common (5–10%). In order to oppose this, gammaglobulin was administered. The amount of gammaglobulin was crucial: too little and side-effects could occur; too much could promote vaccine failure. In 1966 a Medical Research Council (MRC) trial conducted in the UK followed 36 000 children. Measles incidence fell 84% in the first 9 months, and decreased by 14% in the next 2 years. A follow-up study showed that the vaccine remained effective for at least 12 years.

The side-effects and necessity of providing gammaglobulin led to the development of the further attenuated and less reactogenic Schwartz and Moraten (Enders) strains. These were derived from the Edmonston B vaccine by further passage in the chick embryo at lowered temperature. Further MRC trials demonstrated that these were indeed less reactogenic and the incidence of postvaccination febrile convulsions was reduced from 7.7 to 1.9 per 1000 recipients. Both vaccines produced a 95% seroconversion rate, although antibody titres induced by the Schwartz strain declined more rapidly than those produced in response to the Moraten strain but remained at protective levels. In recent years, the Edmonston strain was further attenuated by passing it in human diploid cells. This vaccine, referred to as Edmonston Zagreb strain, has been shown to produce higher seroconversion rates than the Schwartz vaccine when administered at the same age. Similar observations have been made with the AIK-C vaccine, produced in Japan. Titres

of protective antibodies were seen to decline in isolated communities but were still detectable 14 years later. Children living in an open environment showed serological evidence of subclinical re-exposure which acted to boost their immunity. The attenuated strains now in use are so reduced in virulence that encephalitis has only been noted in about 1 in 1 million vaccine recipients, as compared to 1 in 1000–5000 children with natural measles. The measles vaccine is administered subcutaneously, usually between the ages of 9 and 20 months, for primary vaccination. Humoral immune responses, as defined by HI, NT and ELISA, are good and protective as long as the vaccine is given after waning of the maternal antibodies. As with acute measles, the major isotype of MV-specific antibodies is IgG1. Levels of antibodies induced are generally lower than after measles and may decay more rapidly but are still measurable in most individuals 15 years after immunization in the absence of boosting infections. Activation of CMI is generally thought to be similar to that of acute measles, in that both MV-specific CD4 and CD8 T cells are stimulated, although cytotoxic T lymphocyte responses after restimulation *in vitro* are considerably lower than after natural infection. In common with acute measles, administration of live measles vaccine is associated with transient lymphopenia, loss of delayed-type hypersensitivity skin test responses to recall antigen and decreased *in vitro* proliferative responses to mitogens. Both leucopenia and atypical lymphocytosis have also been found after revaccination. Cytokine production after MV vaccination includes a predominant synthesis of IL-4, indicating that T_H1 responses may be inefficiently generated. In general, however, the immunosuppression observed after vaccination is less pronounced than that of acute measles, and is usually not associated with complications. Recent reports that both measles (contracted early in childhood) and measles vaccine would predispose for the later development of intestinal bowel diseases such as Morbus Crohn or ulcerative colitis have not been substantiated (Feeny *et al.*, 1997).

Effectiveness of Vaccination in the Control of Measles

In the prevaccine era, an estimated 4–5 million cases

occurred annually in the United States and by the age of 15 years 95% of the population was seroconverted. Following the rigorous implementation of the MV vaccination programme, case reports have fallen dramatically from 500 000 annually to 26 000 in 1978 and 1500 in 1983; between 1984 and 1988 only 3700 cases were registered (Figure 11.8). As a result of measles vaccination, mortality and AMPE have also declined and the available experience indicates that SSPE can also be prevented by measles vaccination. However, in 1989 and 1990 a dramatic increase in acute measles cases was observed in the United States, rising in 1989 to 18 193 and in 1990 to 27 786 cases (Figure 11.8) (Atkinson and Orenstein, 1992). Measles cases typically occur in two distinct cohorts: preschoolchildren less than 5 years of age, and schoolchildren aged 5–19. In the former group, failure to obtain recommended vaccination is prominent, while in the latter, the majority of patients are infected despite previous vaccination. This indicates that lifelong immunity may not be induced by the application of live measles vaccine. The reasons for vaccine failure may be administration of the vaccine in the presence of maternal antibodies or an inadequate response to vaccination (primary vaccine failure) or loss of immunity in time (secondary vaccine failure). Molecular biological studies of contemporary MV strains revealed sequence changes to past strains which may be associated with different biological properties, although vaccine-induced MV antibodies still neutralize MV isolates from current epidemics. As a result of these measles epidemics, the American Academy of Pediatrics (AAP) and the Immunization Practices Advisory Committee of the USA (ACIP) recommended a change from a one-dose to a two-dose schedule for measles vaccination which is expected to be optimal for measles control and eventual elimination. The first dose of measles vaccination should be administered at 15 months of age, as delayed primary measles vaccination (at 15 months of age or later) significantly reduces measles risk at later ages. Initial vaccination at 12 months of age is recommended for children living in high-risk areas (areas with a large inner-city urban population where more than five cases among preschool-aged children occurred during each of the last 5 years or with recent outbreaks among unvaccinated preschool-aged children). Of course, initial vaccination of infants 12–14 months of age is also recommended before travel to areas in which measles is endemic or

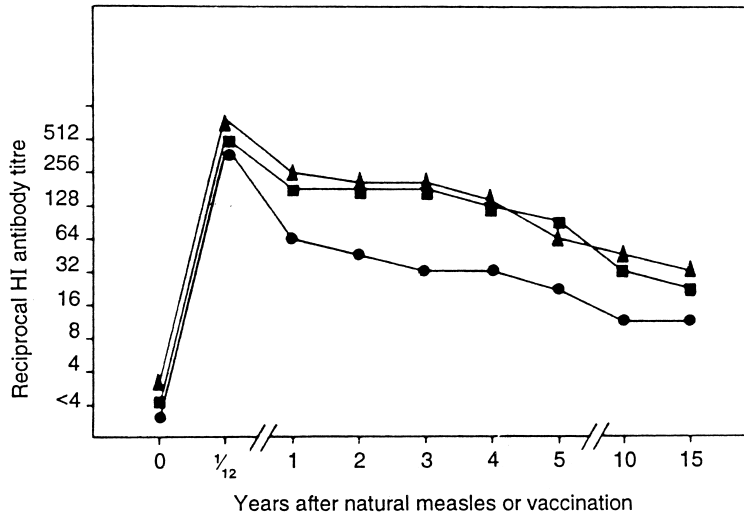

Figure 11.8 Reported number of measles cases in the United States by year, 1950–1990. (Data from the Centers for Disease Control (1991), reproduced with permission from the *Journal of the American Medical Association*, 1991, **266**, 1522–1547. Copyright 1991, American Medical Association)

epidemic. A second dose is recommended at 4–6 years of age by the ACIP (the AAP recommends revaccination at the age of 11–12 years), which is expected to provide protection to most persons who do not respond to their initial vaccination. Persons who received inactivated vaccine and are therefore at risk of developing severe atypical measles after exposure to natural measles should receive two doses of live vaccine separated by not less than 1 month. It is of note that up to 55% of these vaccinees may reveal reactions to the live vaccine, such as local swelling and low-grade fever.

Side-effects of Live Vaccination, Adverse Reactions, Precautions and Contraindications

The vaccine has an excellent record of safety (National Vaccine Advisory Committee, 1991). Although on rare instances a transient rash or low-grade fever may be observed after 5–12 days in some vaccinees, they remain otherwise asymptomatic as for the vast majority of recipients. As with the administration of any agent that can induce fever, some children may have a febrile seizure. Although children with a history of seizures are at increased risk for developing idiopathic epilepsy, febrile seiz-

ures following vaccinations do not increase the probability of subsequent epilepsy or neurological disorders. Most convulsions following measles vaccination are simple febrile seizures, and they affect children without known risk factors. Nevertheless, parents of children who have a personal or family history of seizures should be advised of the small increased risk of seizures following measles vaccination; this is, however, far outweighed by the benefits of the protective effects. CNS conditions such as encephalitis and encephalopathy have been reported with a frequency of less than 1 per million doses administered, an incidence which is lower than that of encephalitis of unknown aetiology. This finding suggests that the reported severe neurological disorders temporally associated with measles vaccination were not caused by the vaccine.

Live measles vaccine should not be administered to women who are pregnant or who are considering becoming pregnant within the next 3 months because of the theoretical risk of fetal infection. The decision to administer or delay vaccination because of a current febrile illness depends on the cause of the illness and the severity of symptoms. Hypersensitivity reactions following the administration of live measles vaccine are rare and usually occur at the injection site. Persons with a history of anaphylactic reactions following egg ingestion should, however, be vaccinated with extreme cau-

tion, and individuals who have experienced anaphylactic reactions to neomycin should not be given the vaccine. Unlike with natural measles, exacerbation of tuberculosis has not been observed after measles vaccination.

Vaccination of Immunocompromised and HIV-infected Individuals

Replication of vaccine viruses can be enhanced in persons with immune deficiency diseases and in those with immunosuppression, as occurs with leukaemia, lymphoma, generalized malignancy, or therapy with alkylating agents, antimetabolites, radiation or large doses of corticosteroids. Thus, patients with such conditions or therapies (except for human immunodeficiency virus (HIV) infection) should not be given live measles vaccine. Short-term corticosteroid therapy does not contraindicate live measles vaccination. The increasing number of infants and preschoolers with HIV infection in certain countries has directed special attention to the appropriate immunization of these children. Asymptomatic children in need of live measles vaccination should receive it without prior evaluation of HIV infection state. Moreover, vaccination should be considered for all symptomatic HIV infected children, including those with the acquired immune deficiency syndrome (AIDS), since measles in these children can be severe. Limited data on measles vaccination among both asymptomatic and symptomatic HIV-infected children indicate that the vaccine has not been associated with severe or unusual adverse events, although antibody responses have been unpredictable. Exposed symptomatic HIV-infected (as well as other immunocompromised persons) should receive high doses of measles Ig regardless of their previous vaccination status.

Vaccination in Developing Countries

In developing countries 1–1.5 million measles-related deaths are reported per year. Measles seems more severe in Africa than on other continents, with a number of countries reporting case fatality ratios higher than in most areas. Infants are at special risk for measles and case fatality ratios are high, both

during the acute phase and the following 9 months. Malnutrition aggravates measles infection, and major complications are pneumonia and diarrhoea which lead to an overall two- or fourfold increase in mortality. Administration of vitamin A has been shown to reduce measles morbidity and mortality.

Vaccination in these areas has so far failed to yield dramatic results. This is largely due to the epidemiology of measles in these areas. Interrupting transmission through vaccination would require high vaccination coverage rates (>90%), and even with extremely high vaccination coverage rates outbreaks can be expected to occur. Measles is particularly severe in infants. Peak incidence of measles occurs in the very young, under 2 years of age, and 97% of cases occur below the age of 5. Vaccination should therefore be performed on younger children than is the case in industrialized countries and frequent revisits to the same area are essential in order to vaccinate the large number of susceptible infants that may be born in a single year. The time of waning of maternal antibodies, the incidence of measles infection in early life and the efficiency of measles vaccination are determinants of the earliest possible age for vaccination against measles. Vaccination is generally performed in industrialized countries at 12 months of age. This is to some extent a compromise between vaccinating at 15 months, when seroconversion would be efficient (95%) but a large number of children would already have contracted measles, and vaccination earlier, before infection, when the success rate of vaccination is lower (50–75% in 6-month-old children) and the risk of side-effects is greater. There is still an ongoing debate over the optimum age at which vaccination should be performed, in particular since recent trials with a high-titre vaccine at the age of 5–6 months suggested an increase in child mortality over control groups (Garenne *et al.*, 1991).

Future studies will undoubtedly lead to further elucidation of the regulatory mechanisms involved in the normal replication of MV. This should in turn lead to a greater understanding of the events preceding measles invasion of the CNS, and possible new avenues of therapy. Moreover, progress made in the molecular biology of MV could lead to the development of genetically engineered measles vaccines which should be free of side-effects and possibly suitable for the immunization of individuals currently at greatest risk, such as young infants or those suffering from chronic debilitating diseases.

REFERENCES

- Arnold, W., Niedermayer, H.P., Lehn, N. *et al.* (1996) Measles virus in otosclerosis and the specific immune response of the inner ear. *Acta Otolaryngologica*, **116**, 705–709.
- Atkinson, W.L. and Orenstein, W.A. (1992) The resurgence of measles in the United States, 1989–1990. *Annual Review of Medicine*, **43**, 451–463.
- Baczko, K., Liebert, U.G., Billeter, M. *et al.* (1986) Expression of defective measles virus genes in brain tissues of patients with subacute sclerosing panencephalitis. *Journal of Virology*, **59**, 472–478.
- Baczko, K., Liebert, U.G., Cattaneo, R. *et al.* (1988) Restriction of measles virus gene expression in measles virus inclusion body encephalitis. *Journal of Infectious Diseases*, **158**, 144–150.
- Baslé, M.F., Fournier, J.G., Rozenblatt, S. *et al.* (1986) Measles virus RNA detected in Padgett's disease bone tissue by *in situ* hybridization. *Journal of General Virology*, **67**, 907–913.
- Bellini, W.J., Englund, G., Rozenblatt, S. *et al.* (1985) Measles virus P gene codes for two proteins. *Journal of Virology*, **53**, 908–919.
- Carter, M.J., Willcocks, M.M. and ter Meulen, V. (1983) Defective translation of measles virus matrix protein in a subacute sclerosing panencephalitis cell line. *Nature*, **305**, 153–155.
- Cattaneo, R., Schmid, A., Rebmann, G. *et al.* (1986) Accumulated measles virus mutations in a case of subacute sclerosing panencephalitis: interrupted matrix protein reading frame and transcription alteration. *Virology*, **154**, 97–107.
- Cattaneo, R., Rebmann, G., Baczko, K. *et al.* (1987) Altered ratios of measles virus transcripts in diseased human brains. *Virology*, **160**, 523–526.
- Cattaneo, R., Schmid, A., Eschle, D., *et al.* (1988) Biased hypermutation and other genetic changes in defective measles viruses in human brain infections. *Cell*, **55**, 255–265.
- Centers for Disease Control (1991) Measles—United States 1990. *Morbidity and Mortality Weekly Report*, **40**, 369–372.
- Centers for Disease Control (1996a) Measles—United States 1995. *Morbidity and Mortality Weekly Report*, **45**, 415–418.
- Centers for Disease Control (1996b) Measles pneumonitis following measles-mumps-rubella vaccination of a patient with HIV infection, 1993. *Morbidity and Mortality Weekly Report*, **45**, 603–6068.
- Dörries, R. and ter Meulen, V. (1984) Detection and identification of virus-specific, oligoclonal IgG in unconcentrated cerebrospinal fluid by immunoblot technique. *Journal of Neuroimmunology*, **7**, 77–89.
- Dörries, R., Liebert, U.G. and ter Meulen, V. (1988) Comparative analysis of virus-specific antibodies and immunoglobulins in serum and cerebrospinal fluid of subacute measles virus-induced encephalomyelitis (SAME) in rats and subacute sclerosing panencephalitis (SSPE). *Journal of Neuroimmunology*, **19**, 339–352.
- Feeney, M., Clegg, A., Winwood, P. *et al.* (1997) A case-control study of measles vaccination and inflammatory bowel disease. *Lancet*, **350**, 764–766.
- Fraser, K.B. and Martin, S.J. (1978) *Measles Virus and Its Biology*. Academic Press, London.
- Garene, M., Leroy, O., Beau, J.-P. *et al.* (1991) Child mortality after high-titre measles vaccines: prospective study in Senegal. *Lancet*, **338**, 903–907.
- Griffin, D.E. and Bellini, W.J. (1996) Measles Virus. In *Fields Virology*, 3rd edn (eds B.N. Fields, D.M. Knipe, P.M. Howley *et al.*), p 1267. Lippincott-Raven, Philadelphia.
- Hirsch, H.L., Griffin, D.E., Johnson, R.T. *et al.* (1984) Cellular immune responses during complicated and nonuncomplicated measles virus infections of man. *Clinical Immunology and Immunopathology*, **31**, 1–12.
- Johnson, R.T. and Griffin, D.E. (1986) Virus induced autoimmune demyelinating disease of the CNS. In *Concepts in Viral Pathogenesis* (eds A.L. Notkins and M.B.A. Oldstone), pp 203–209. Springer-Verlag, New York.
- Karp, C.L., Wysocka, M., Wahl, L.M. *et al.* (1996) Mechanism of suppression of cell-mediated immunity by measles virus. *Science*, **273**, 228–231.
- Katayama, Y., Hotta, H., Nishimura, A. *et al.* (1995) Detection of measles virus nucleoprotein mRNA in autopsied brain tissues. *Journal of General Virology*, **76**, 3201–3204.
- Kobune, F., Sakata, H. and Sugiura, A. (1990) Marmoset lymphoblastoid cells as a sensitive host for isolation of measles virus. *Journal of Virology*, **64**, 700–705.
- Liebert, U.G., Baczko, K., Budka, H. *et al.* (1986) Restricted expression of measles virus proteins in brains from cases of subacute sclerosing panencephalitis. *Journal of General Virology*, **67**, 2435–2444.
- Liebert, U.G., Schneider-Schaulies, S., Baczko, K. *et al.* (1990) Antibody-induced restriction of viral gene expression in measles encephalitis in rats. *Journal of Virology*, **64**, 706–713.
- McKenna, M.J., Kristiansen, A.G. and Haines, J. (1996) Polymerase chain reaction amplification of a measles virus sequence from human temporal bone sections with active otosclerosis. *American Journal of Otolaryngology*, **17**, 827–830.
- Mitchell, C.D. and Balfour, H.H. (1985) Measles control: so near and yet so far. *Progress in Medical Virology*, **31**, 1–42.
- Nakayama, T., Mori, T., Yamaguchi, S. *et al.* (1995) Detection of measles virus genome directly from clinical samples by reverse transcriptase polymerase chain reaction and genetic variability. *Virus Research*, **35**, 1–16.
- National Vaccine Advisory Committee (1991) The measles epidemic: the problems, barriers, and recommendations. *JAMA*, **266**, 1547–1552.
- Niewiesk, S., Eisenhuth, I., Fooks, A. *et al.* (1997) Measles virus induced immune suppression in the cotton rat (*Sigmodon hispidus*) model depends on viral glycoproteins. *Journal of Virology*, **71**, 7214–7219.
- Oldstone, M.B.A. and Fujinami, R.S. (1982) Virus persistence and avoidance of immune surveillance: how measles viruses can be induced to persist in cells, escape immune assault and injure tissues. In *Virus Persistence* (eds B.W.T. Mahy, A.C. Minson and G.K. Darby), pp 185–202, Cambridge University Press, Cambridge.
- Radecke, F. and Billeter, M.A. (1996) The nonstructural C protein is not essential for multiplication of Edmonston B strain measles virus in tissue culture cells. *Virology*, **217**, 418–421.
- Radecke, F., Spielhofer, P., Schneider, H. *et al.* (1995) Rescue of measles viruses from cloned cDNA. *EMBO Journal*, **14**, 5773–5784.
- Reddy, S., Singer, F., Mallette, L. *et al.* (1996) Detection of measles virus nucleocapsid transcripts in circulating blood cells from patients with Paget's disease. *Journal of Bone and Mineral Research*, **11**, 1602–1607.
- Rima, B.K., Baczko, K., Clarke, D.K. (1986) A complete tran-

- scriptional map for morbilliviruses. *Journal of General Virology*, **67**, 1971–1978.
- Rota, J.S., Hummel, K.B., Rota, P.A. *et al.* (1992) Genetic variability of the glycoprotein genes of current wild-type measles isolates. *Virology*, **188**, 135–142.
- Sanchez-Lanier, M., Guerin, P., McLaren, L.C. *et al.* (1988) Measles virus-induced suppression of lymphocyte proliferation. *Cellular Immunology*, **116**, 367–381.
- Schlender, J., Schnorr, J.J., Spielhofer, P. *et al.* (1996) Interaction of measles virus glycoproteins with the surface of uninfected peripheral blood lymphocytes induces immunosuppression *in vitro*. *Proceedings of the National Academy of Sciences of the USA*, **93**, 13194–13199.
- Schneider-Schaulies, S. and ter Meulen, V. (1992) *Molecular Aspects of Measles Virus-Induced Central Nervous System Diseases*, (ed. R.P. Ross), pp 449–472. Humana Press, Totowa, NJ.
- Schneider-Schaulies, S., Liebert, U.G., Baczko, K. *et al.* (1990) Restricted expression of measles virus in primary rat astroglial cells. *Virology*, **177**, 802–806.
- Schneider-Schaulies, J., Schnorr, J.J., Brinckmann, U. *et al.* (1995) Receptor usage and differential downregulation of CD46 by measles virus wildtype and vaccine strains. *Proceedings of National Academy of Sciences of the USA*, **92**, 3943–3947.
- Schneider, H., Kaelin, K. and Billeter, M.A. (1997) Recombinant measles viruses defective for RNA editing and V protein synthesis are viable in cultured cells. *Virology*, **227**, 314–322.
- Schnorr, J.J., Xanthakos, S., Keikavoussi, P. *et al.* (1997) Induction of maturation of human blood dendritic cell precursors by measles is associated with immunosuppression. *Proceedings of the National Academy of Sciences of the USA*, **94**, 5326–5331.
- Sheppard, R.D., Raine, C.S., Bornstein, M.B. *et al.* (1986) Rapid degradation restricts measles virus matrix protein expression in a subacute sclerosing panencephalitis cell line. *Proceedings of the National Academy of Sciences of the USA*, **83**, 7913–7917.
- Tamashiro, V.G., Perez, H.H. and Griffin, D.E. (1987) Prospective study of the magnitude and duration of changes in tuberculin reactivity during complicated and uncomplicated measles. *Pediatric Infectious Disease Journal*, **6**, 451–454.
- ter Meulen, V. and Billeter, M.A. (eds) (1995) Measles virus. *Current Topics in Microbiology and Immunology*, **191**.
- ter Meulen, V. and Carter, M.J. (1984) Measles virus persistency and disease. *Progress in Medical Virology*, **30**, 44–61.
- ter Meulen, V. and Hall, W.W. (1978) Slow virus infections of the nervous system: virological, immunological and pathogenetic considerations. *Journal of General Virology*, **41**, 1–25.
- ter Meulen, V., Stephenson, J.R. and Kreth, H.W. (1983) Subacute sclerosing panencephalitis. *Comprehensive Virology*, **18**, 105–159.
- Wechsler, S.L. and Meissner, H. (1982) Measles and SSPE viruses: similarities and differences. *Progress in Medical Virology*, **28**, 65–95.

Rubella

Jennifer M. Best and Jangu E. Banatvala

Guy's, King's and St Thomas' School of Medicine, London, UK

HISTORICAL INTRODUCTION

Rubella was known initially as 'German measles' because it was first described by two German physicians in the mid-eighteenth century and was originally known by a German name, 'Roteln'. For many years German measles was confused with other diseases causing a rash, such as measles and scarlet fever. It was eventually recognised as a distinct disease by an International Congress of Medicine in London in 1881. The name 'rubella' was accepted at about that time. The main historical events associated with rubella are summarized in Table 12.1. Being a generally mild disease, it received comparatively little attention after 1881 until its association with congenital defects was recognised in 1941 by N. McAlister Gregg, an Australian ophthalmologist. He observed that 78 babies with a similar type of congenital cataract, some also with heart disease, were born after an extensive rubella epidemic in 1940 (Gregg, 1941). All but 10 of the mothers had a history of rubella, usually in the first or second month of pregnancy. These findings were confirmed by other Australian workers, who also observed deafness and microcephaly. Deafness occurred in infants whose mothers were infected slightly later in pregnancy (mean, 2.1 months gestation), whereas congenital cataracts occurred in infants whose mothers had had rubella on average at 1.5 months gestation. Other retrospective studies in Australia as well as in other countries confirmed these findings (reviewed by Hanshaw *et al.*, 1985).

These retrospective studies, in which the starting

point for investigations was an infant with congenital deformities, suggested that a very high proportion of mothers who had had rubella during pregnancy were delivered of infants with congenital malformations. For example, Gregg, in a more extensive survey, reported that 122 of 128 (95%) children whose mothers had had rubella before the 16th week of gestation had congenital defects. He also reported the birth of six normal infants following rubella in early pregnancy.

Prospective studies, which were designed to give a more accurate assessment of the risk of maternal rubella, were carried out in the 1950s and early 1960s. These studies showed that the incidence of congenital malformation following maternal rubella was 10.2–54.2%, much less than that shown by retrospective studies. However, these studies were based on a clinical diagnosis of maternal rubella, which is now known to be unreliable. Consequently, the incidence of congenital malformation was probably underestimated, since many women who did not have rubella and who were delivered of normal babies were probably included. More recent studies involving pregnant women with serologically proven rubella are discussed on pages 400–401.

Virological Studies

Early work on the characteristics and transmission of rubella was carried out in monkeys and human volunteers. It was first demonstrated that rubella could be transmitted by bacteria-free filtrates in

Table 12.1 Main historical events

1881	Rubella accepted as a distinct disease by International Congress of Medicine
1938	First evidence to show that rubella was caused by a virus
1941	Teratogenic effects of rubella first recognized by Gregg in Australia
1962	<i>Rubella virus</i> isolated in cell cultures. Neutralization test developed
1963–1964	Extensive epidemics of rubella in USA and Europe
1965–1967	Development of attenuated vaccine strains and first vaccine trials
1967	<i>Rubella virus</i> shown to haemagglutinate. Haemagglutination inhibition (HI) test developed
1969	USA: HPV77.DE5 and Cendehill vaccine strains licensed. Vaccination offered to all preschool children
1970	UK: Cendehill vaccine strain licensed. Vaccination offered to all 11–14-year-old schoolgirls
1971	USA: MMRI ^a licensed
1972	UK: Rubella vaccination extended to all susceptible adult women of childbearing age, including women attending antenatal clinics. Susceptible pregnant women offered vaccination in the immediate postpartum period
1977	USA: National Childhood Immunization initiative—intensification of rubella vaccination of teenagers and susceptible adult women
1978–1979	UK: Rubella epidemics; 124 cases of congenitally acquired rubella and 1405 terminations of pregnancy due to rubella or rubella contact
1979	USA: RA27/3 replaced other vaccine strains
1983	UK: Rubella epidemic. Further intensification of vaccination campaign
1988	UK: Vaccination policy augmented by offering MMR to preschool children of both sexes. MMR11 ^b licensed
1996	UK: Schoolgirl vaccination discontinued; children offered second dose of MMR at 4–5 years of age
1997	USA: Change in policy: children offered first dose of MMR at 12–15 months and second dose at 4–6 years of age

^a MMR1 contained *Measles virus* (Moraten strain), *Mumps virus* (Jeryl Lynn) and RV (HPV77.DE5).

^b MMR vaccines licensed in the UK contain *Measles virus* (Schwartz strain), *Mumps virus* (Jeryl Lynn) and RV (RA27/3 strain).

1938. Between 1949 and 1953, further experimental studies using human volunteers showed that the incubation period of rubella ranged from 13 to 20 days. Subclinical infection was demonstrated, since secondary cases of rubella occurred in contacts of volunteers inoculated with serum who had not themselves developed a rash.

Rubella virus (RV) was not isolated in cell cultures until 1962, when two groups of workers published simultaneously methods for the isolation of RV. Parkman and his colleagues (1962) inoculated primary vervet monkey kidney (VMK) cultures with throat washings obtained from military recruits when rash was present. Although no cytopathic effect (CPE) was observed, when cultures were challenged 7–14 days after inoculation with 10⁴ TCID₅₀ *Echovirus 11* (EV11), the distinct CPE produced by this virus was not observed, suggesting the presence of an interfering agent. The interfering agent was neutralized by rabbit antiserum raised against one of the isolates. Weller and Neva (1962) also isolated the virus from blood and urine taken from typical cases of rubella in primary human amnion cultures. After specimens were passed once or twice in these cell cultures, a characteristic CPE with cytoplasmic inclusions was observed. These effects were neutralized by serum obtained from patients convalescent from rubella. The agents isolated in the different cell cultures by these two

groups of workers were exchanged and found to be identical.

It was subsequently shown that RV induced interference in continuous lines of monkey kidney and that viruses other than EV11 (e.g. *Coxsackievirus A9*, *Bovine enterovirus M-6* and *Vesicular stomatitis virus*) could be used to challenge rubella-infected cell cultures. Many other primary and continuous cultures were subsequently shown to support the growth of RV.

Rubella-neutralizing antibodies were detected by Parkman and his colleagues (1962), who demonstrated that convalescent sera neutralised the interference effect produced by a standard inoculum of RV. The presence of neutralising antibodies was shown to be associated with protection against reinfection. This technique was used extensively for diagnostic purposes and serological surveys. Studies conducted in different countries showed that the acquisition of rubella antibodies was related to age, social class and geographical location, and that approximately 80% of women of childbearing age living in urban areas in Western countries were immune. Initial attempts to develop a haemagglutination inhibition (HI) test were unsuccessful, since it was not appreciated that inhibitors of haemagglutination, now known to be serum lipoproteins, were present both in the serum incorporated in culture medium and in the test sera. Details of a

successful HI test were published in 1967 (Stewart *et al.*, 1967).

Clinical and virological investigations carried out during the extensive rubella epidemic in the USA during the winter and spring of 1963–1964 led to a greater understanding of the pathogenesis of congenitally-acquired rubella (CAR), as well as a further appreciation of its clinical features and sequelae. During this epidemic many pregnant women were inevitably infected and this resulted in the delivery of about 30 000 rubella-damaged babies (Cooper, 1975). Studies at the time revealed that multisystem involvement was common and the range of abnormalities much wider than previously reported. When maternal rubella occurred in early pregnancy, a generalized infection developed in the fetus which persisted during the remainder of gestation and into infancy, despite the presence of rubella antibodies. Many infected infants excreted virus and transmitted virus to susceptible contacts. This epidemic highlighted the importance of developing a vaccine rapidly.

PROPERTIES OF THE VIRUS

Classification

Rubella virus is classified as a non-arthropod-borne togavirus and is the only member of the genus *Rubivirus*. The overall structure and strategy of gene expression of RV is similar to that of the alphaviruses of the *Togaviridae*, such as Semliki-Forest and Sindbis (Frey, 1994). By HI, however, no antigenic relationship has been shown between rubella and more than 200 alphaviruses and flaviviruses. Humans are the only known hosts for RV.

Structure of the Virus

The virus particle is 58 ± 7 nm in diameter, while the nucleocapsid is 33 ± 1 nm in diameter and surrounds the RNA genome (Figures 12.1 and 12.2). The virion consists of two membrane-bound glycoproteins E1 (58 kDa) and E2 (42–47 kDa) and C, a non glycosylated capsid protein. The symmetry of the nucleocapsid was difficult to establish due to its instability, but an icosahedron with 32 cap-

somers has been described. The lipoprotein envelope bears surface spikes of 5–8 nm composed of the two glycoproteins. The non-rigid delicate character of the envelope results in the virus particle being pleomorphic; elliptical and oblong virus particles and particles bearing finger-like protrusions have been described.

Rubella virus contains a single positive-strand polyadenylated 40S RNA of 9762 nucleotides excluding the poly(A) tail, and is capped at the 5' end (Frey, 1994; Pugachev *et al.*, 1997). The RNA is infectious when extracted under appropriate conditions. The base composition of the genome is G 30.8%, C 38.7%, A 14.9% and U 15.4%. The genome consists of two non-overlapping open reading frames (ORFs) separated by an untranslated region of 123 nucleotides. The 5' proximal ORF is 6348 nucleotides in length and codes for a polyprotein precursor of the non-structural (NS) proteins. The 3' proximal ORF is 3189 nucleotides in length and codes for the polyprotein precursor of the structural proteins (Figure 12.3). The complete genomes of three strains of RV have been sequenced: M33 and Therien, which are wild-type strains isolated in the USA in the early 1960s, and the RA27/3 vaccine strain. Sequencing has been difficult due to the high GC content of the genome (69%) and several mistakes appeared in early sequences (Frey, 1994; Pugachev *et al.*, 1997). RA27/3 differs from M33 and Therien at 36 nucleotides, 18 of which are silent with respect to amino acid coding. As sequence differences are maintained in virus recovered from vaccinees, they can be used to identify this attenuated strain in clinical specimens. Other sequencing studies, which have concentrated on the E1 ORF, have demonstrated that the genome sequence is stable and there is no evidence of antigenic drift, even in highly vaccinated populations (Best *et al.*, 1993; Frey *et al.*, 1998). However, two genotypes have been described, with some isolates from China and India differing from isolates from Europe, North America and Japan by 8–10% of nucleotides, but by only 1–3% at the amino acid level (Bosma *et al.*, 1996; Frey *et al.*, 1998). There is no evidence that reinfection is due to an antigenic variant, but two viruses isolated from joints exhibited changes in antigenic epitopes in E1 (Bosma *et al.*, 1996; Frey *et al.*, 1998). Thus, the level of diversity is low when compared with some alphaviruses and other RNA viruses, such as human immunodeficiency virus (HIV) and poliovirus.

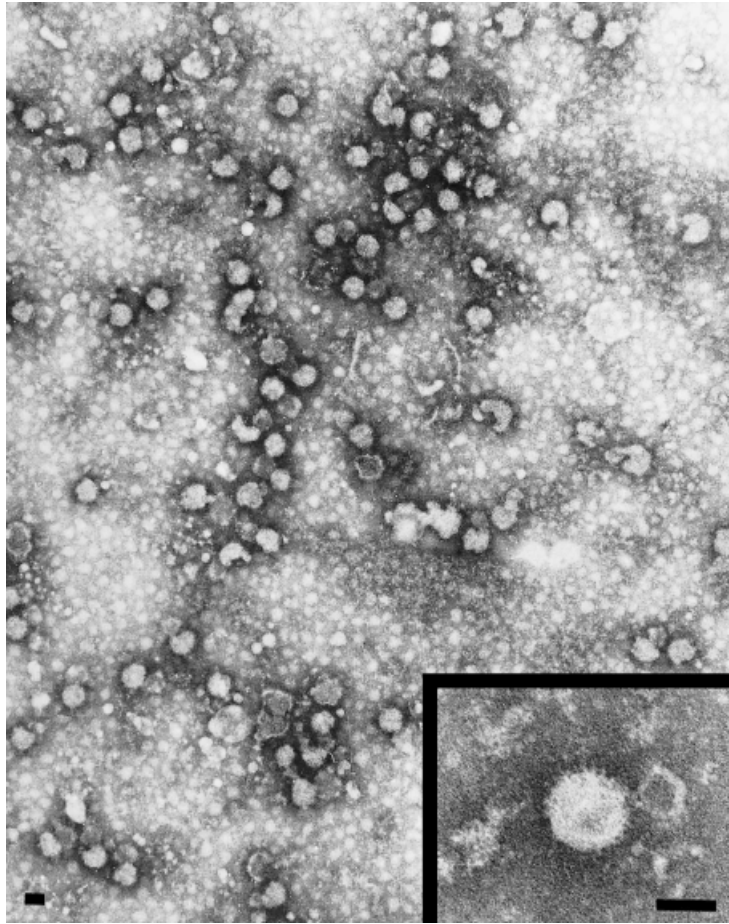

Figure 12.1 Negatively stained preparation of rubella virus. Inset: an enlarged particle, showing spikes. (Bar = 50 nm.) (Kindly provided by Dr I. Chrystie; reproduced with permission from Banatvala and Best, *Topley and Wilson*, 9th edition, Vol. 1)

Replication

Rubella virus probably enters the cell by receptor-mediated endocytosis. Although the cellular receptor for the virus has not been identified, membrane phospholipids and glycolipids are probably involved, which may explain the wide tissue tropism of the virus. The reproductive cycle takes place in the cytoplasm and probably resembles that of the alphaviruses. The virion is internalized in clathrin coated pits and transported to the endosomal compartment, where the low pH brings about the uncoating of the viral genome and fusion of the E1 and E2 glycoproteins with the endosomal membranes, which allows the viral genome to be released into the cytoplasm.

The virion RNA is translated to produce the 2116 amino acid polyprotein encoded by the 5' proximal ORF. This polyprotein is cleaved to give two products of 150 and 90 kDa. Within these products there are two global amino acid motifs, indicative of replicase and helicase activity, and a cysteine protease (Figure 12.3). An X motif of unknown function is also present, which is a short region of homology between RV and Sindbis (an alphavirus) genomes. The NS proteins appear to interact with host cell proteins to produce a negative-sense genome. This is used as a template for the production of both full-length 40S progeny genomes and 24S subgenomic RNA. The 24S subgenomic RNA, which is capped, methylated and polyadenylated, is translated to produce a 110 kDa polyprotein, which is cleaved by a host cell signal peptidase to produce

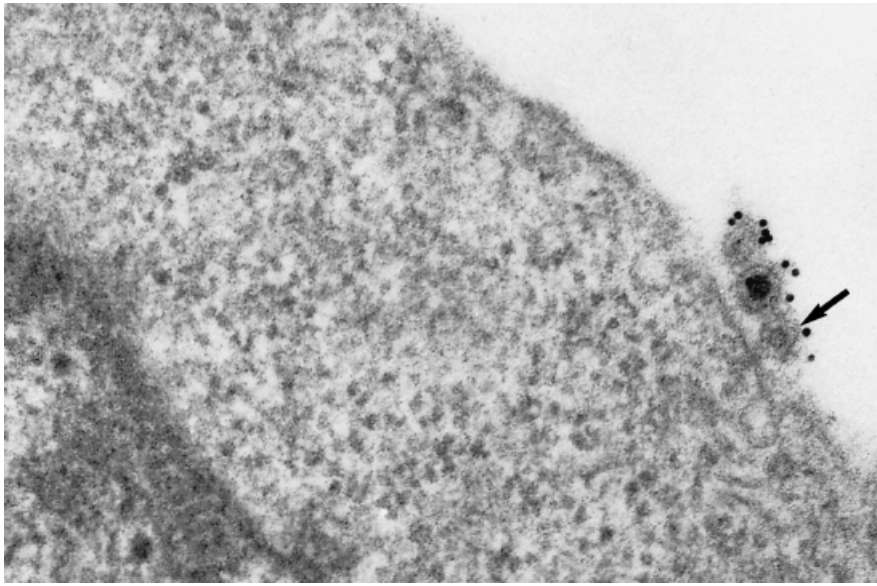

Figure 12.2 Vero cell culture 4 days after infection with *Rubella virus*. Virions are budding (arrow) from cell surface membrane. Virions are labelled with antirubella antibody (polyclonal) and colloidal gold probe (GAR G10; $\times 103\ 200$). (Courtesy of Dr S. Pathak.)

the three structural proteins C, E2 and E1 (Figure 12.3). All three structural proteins are transported to the Golgi complex. E1 and E2 form heterodimeric complexes, while the C protein forms non-covalently bonded dimers, which are stabilized by disulphide bond formation shortly before virus release.

In cell cultures RV is released by budding from intracellular membranes (e.g. Golgi, endoplasmic reticulum) and from the plasma membrane. The RNA-containing nucleocapsid cores bud from the cellular membranes, where they acquire an envelope consisting of the E1 and E2 glycoproteins and host cell lipids, to form mature virus particles. The ability to bud from intracellular vacuoles allows the virus to evade the host's immune response, which may enable the virus to establish persistent infections (Wolinsky, 1996).

In vertebrate cell cultures the replication of RV is slow and less efficient than that of the alphaviruses. In Vero cells virus production reaches a peak at 48 hours after infection at high multiplicities of infection (Hemphill *et al.*, 1988) and infection has no effect on total cell RNA synthesis. Defective interfering RNAs have been detected. Membrane alterations and vacuolation are observed in infected cells by electron microscopy. Membrane-bound cytoplasmic vacuoles are replication complexes recently shown to be virus-modified lysosomes (Magliano *et al.*, 1998). These structures are the site of virus

replication and are similar to structures found in alphavirus-infected cells.

The structure and replication of RV have been reviewed in more detail by Frey (1994) and Wolinsky (1996).

Physical and Chemical Properties of the Virus

Physical properties of RV have been reviewed by Horzinek (1981) and Banatvala and Best (1998). The stability of the virus is enhanced by the addition of proteins to the suspending medium. $MgSO_4$ appears to improve the thermostability of the virus.

Rubella virus is inactivated by detergents and organic solvents, since the viral envelope contains lipid. The effects of these and other chemicals have been extensively reviewed elsewhere (Norrby, 1969; Herrmann, 1979; Frey, 1994).

Antigenic Characteristics

Early work on RV identified haemagglutinating (HA), complement fixing, platelet aggregating and haemolytic activity. Methods for producing HA and complement fixing antigens have been reviewed

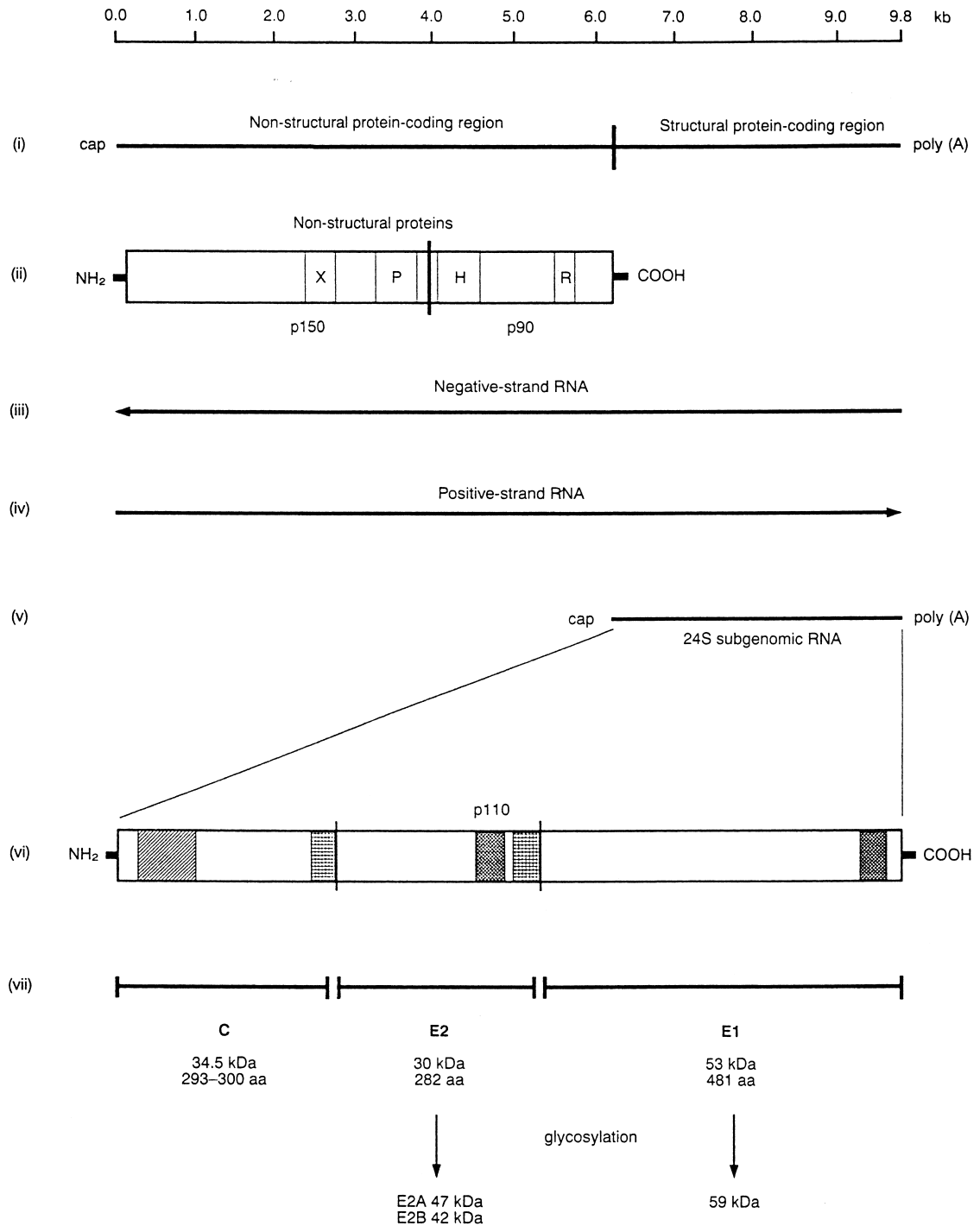

Figure 12.3 Map of the rubella virus genome and strategy for the expression of rubella virus structural proteins. Translation of rubella RNA (i) results in production of non-structural proteins (ii), which initiate the synthesis of a full-length negative strand of RNA (iii), which acts as template for the synthesis of both full-length positive strand for new viral progeny (iv) and 24S subgenomic RNA (v). Translation of this 24S RNA results in the production of p110, a polyprotein (vi) which is proteolitionally cleaved to produce the three structural proteins C, E2 and E1 (vii). Within the non-structural ORF the location of global amino acid motifs indicative of replicase (R), helicase (H) and cysteine protease (P) activity are indicated. X indicates a region of homology between rubella and alphaviruses. ▨ hydrophilic domain of C, putatively interacts with virion RNA; ▩ hydrophobic signal sequences that precede the N terminal of E2 and E1; ▤ the transmembrane sequences of E2 and E1. (Reproduced with permission from Banatvala and Best, *Topley and Wilson*, 9th edition, Vol. 1)

elsewhere (Banatvala and Best, 1998).

Humoral and cell-mediated responses are produced against all three structural proteins, although E1 appears to be immunodominant (Cusi *et al.*, 1989; Chaye *et al.*, 1992). Information on immunoreactive regions within the structural proteins has been obtained using monoclonal antibodies to map epitopes and by measuring antibody reactivity and T cell proliferative responses to synthetic peptides and recombinant proteins. E1 has been shown to have at least six independent linear epitopes, including two or three neutralizing epitopes, within the amino acid region 214–285 (Terry *et al.*, 1988; Wolinsky *et al.*, 1991; Chaye *et al.*, 1992; Mitchell *et al.*, 1992). However, conformation-dependent epitopes may also play an important role in the induction of immune responses, and these have not been identified. The E2 glycoprotein in the mature virion appears to be relatively inaccessible to the immune response, but a number of B cell epitopes have been identified (Green and Dorsett, 1986; Wolinsky *et al.*, 1991; Mitchell *et al.*, 1993). Strain specific antigens have been identified on E1 and E2 using Western blotting (Dorsett *et al.*, 1985; Cusi *et al.*, 1989). Human sera react with synthetic peptides comprising residues 214–285 of the E1 protein, and a recombinant protein containing these epitopes was recognized by most rubella antibody-positive sera (Starkey *et al.*, 1995). At least five T cell epitopes have been identified on E1. There appear to be no generally recognized T helper cell epitopes on E1, although the region E1 202–283 appears to be recognised by both B and T cells from some individuals. Responses detected using T cell lines are considered to be more specific. However, most investigators have used peripheral blood mononuclear cells (PBMCs). Marttila *et al.* (1996) were unable to detect proliferative responses to synthetic peptides when PBMCs were used, but when T cell lines from 14 seropositive individuals were employed, three minimal T helper cell epitopes were identified on E1. At least four T and two B cell epitopes have been identified on the C protein (Wolinsky *et al.*, 1991; Ou *et al.*, 1992; Mitchell *et al.*, 1994).

Growth in Cell Cultures

Rubella virus grows in a wide range of primary and

continuous cell cultures (Herrmann, 1979). It induces a CPE only in such continuous cell cultures as RK13 (rabbit kidney), SIRC (rabbit cornea) and Vero (VMK), providing conditions are controlled carefully. These cell cultures, together with primary VMK cell cultures, have been used most frequently for virus isolation. Virus is identified in primary VMK by interference. Vero cells are useful for virus isolation because they do not produce interferon, and virus can therefore replicate more rapidly to high titre. Since RV does not produce CPE in all sublines of Vero cells, passage into another cell line has been used for virus identification. Although RV produced a characteristic CPE in RK13 and SIRC cells, the virus may be identified more reliably in both these and Vero cell cultures by immunofluorescence (IF) or polymerase chain reaction (PCR) (p 407).

BHK-21 and Vero cell cultures are used extensively for producing high titres of RV, which are required for use as antigens in serological tests (p 406).

Rubella-induced interference is probably associated with the interferon pathway, although interferon is not always detected in infected cell cultures. RV also induces intrinsic interference—that is, resistance to superinfection by high multiplicities of *Newcastle disease virus* in human fibroblasts, induced by the viral genome.

The growth of RV in cell cultures and organ cultures has been reviewed by Banatvala and Best (1990).

Pathogenicity for Animals

Rubella virus infects rhesus (*Cercopithecus aethiops*), vervet (*Macaca mulatta*) and *Erythrocebus patas* monkeys, marmosets (*Sanguinus* species), chimpanzees, baboons, suckling mice, hamsters, ferrets and rabbits (reviewed by Herrmann, 1979; Banatvala and Best, 1990). Monkeys usually develop a sub-clinical infection with viraemia, virus excretion and an immune response, similar to that in humans (p 397). A viraemia and humoral and cell-mediated immune responses have been detected in 6–8-week-old BALB/c mice (Wolinsky, 1996). Persistent infection has been established in suckling mice, adult hamsters, ferrets and rabbits. Vaccinia-expressed E1 and E2 proteins have induced autoantibodies to

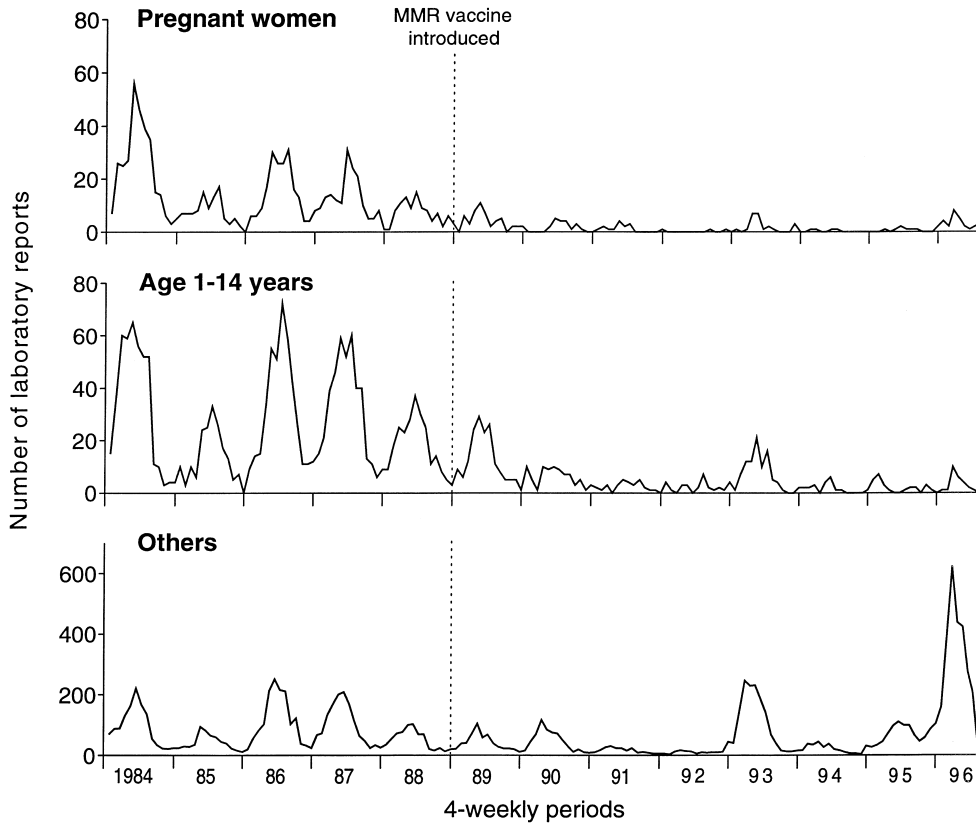

Figure 12.4 Serologically confirmed laboratory reports of rubella, England and Wales: 1984 to July 1996 (Miller *et al.*, 1997) (Reproduced with permission of the PHLS Communicable Disease Surveillance Centre © PHLS)

pituitary cells and autoimmune lymphocytic hypophysitis in Syrian hamsters (Yoon *et al.*, 1992).

Attempts to reproduce the teratogenic effects of RV in an animal model have produced inconsistent results. The monkey is the only animal whose reproductive process is similar to that of humans, but even in these animals results have not been reproducible. Thus, some workers isolated rubella from conceptuses but no malformations were observed. An increased rate of spontaneous abortion and lenticular changes were observed in some studies, while others failed to isolate virus or to find evidence of malformation, although they showed that an immune response developed *in utero*. Congenital infection has been reported in rabbits, ferrets and rats, but these reports could not be confirmed, the occurrence of malformations being inconsistent. Insufficient attention was given in these studies to the use of adequate controls and such factors as virus passage history, species adaptation, route of

inoculation, nutrition and the effects of increased handling of the animals.

POSTNATALLY ACQUIRED INFECTION

Epidemiology

Rubella has a worldwide distribution. Before the introduction of vaccination, outbreaks usually occurred in the spring and early summer in temperate climates. Infection is uncommon in preschool children, but outbreaks involving schoolchildren and young adults living in institutional population groups are common. Women of childbearing age are often infected as a result of exposure to children within their household or as a result of occupational exposure. Unlike measles, rubella does not exhibit

characteristic periodicity. Occasionally, extensive worldwide pandemics occur; for example, in the early 1940s and again between 1963 and 1965, when a high incidence was reported in the USA, the UK and Australia. More commonly, rubella exhibits an increased incidence every 3–4 years, although within a particular country epidemics may be localized to certain areas only. Thus, in the UK, extensive outbreaks of rubella occurred in 1978–1979, 1982–1983, 1993 and more recently in 1996 (Figure 12.4). The augmentation of the rubella vaccination programme in 1988, in which MMR was offered to preschool children of both sexes (p 414), resulted in a marked reduction in the incidence of rubella, with the lowest ever number of cases reported in 1992 (Miller *et al.*, 1993). The 1996 outbreak was largely confined to 17–24-year-old males who had never been offered rubella vaccine; about 16% of males in this age group were susceptible. Fortunately, transmission of rubella to pregnant women was limited, since 98–99% were immune, either as a result of naturally acquired infection or vaccination as schoolgirls or post partum.

Since rubella is not a notifiable disease in many countries, and the clinical diagnosis is unreliable, seroepidemiological studies provide a more accurate assessment of the incidence of rubella in different age groups and in different geographical areas. Despite serological tests being carried out by different techniques in different laboratories, surveys have produced remarkably consistent results. Thus, in temperate climates, the proportion of seropositive persons increases progressively with age. In general, about 50% of 9–11-year-old children have rubella antibodies. In the prevaccination era, about 80–85% of women of childbearing age were found to be immune (Dowdle *et al.*, 1970).

Although CAR is now a rare disease in those developed countries which have adopted rubella vaccination programmes, the burden induced by congenitally acquired infection imposes a considerable strain on scarce health and educational resources in many developing countries. Unfortunately, this is insufficiently appreciated. The proportion of susceptible women in many developing countries, although exhibiting considerable variation even within different parts of a country, shows that the proportion of women susceptible to rubella (15–20%) is little different from that in industrialized countries in the prevaccine era (Cutts *et al.*, 1997; Robertson *et al.*, 1997); susceptibility rates of

more than 25% were reported from only 12 of the 45 developing countries surveyed. Particularly high susceptibility rates occurred in island populations, e.g. Trinidad and Tobago and Jamaica, although many islands are now adopting vaccination programmes.

Although outbreaks of rubella may not always be recognized in developing countries, or rubella-induced rashes misdiagnosed, the incidence of congenital rubella has recently been reported to have been considerably higher (range 0.6–2.2 per 1000 live births) than during the early years of the rubella vaccination programme in Britain (0.14 per 1000 during epidemics; at other times, 0.08 per 1000). Mathematical modelling from five WHO regions, excluding Europe, during 1998 estimated that there were approximately 236 000 cases of CAR in developing countries during non-epidemic years; following epidemics the number might show as much as a tenfold increase (Salisbury and Savinykh, 1991).

Clinical and Virological Features of Primary Infection

Rubella is spread mostly by droplet via the respiratory route. The epithelium of the buccal mucosa and the lymphoid tissue of the nasopharynx and upper respiratory tract probably represent the site of initial virus replication, following which rubella spreads to the lymphatic system and establishes a systemic infection. It is likely that mononuclear cells are involved in dissemination of virus to different parts of the body, although extracellular virus may be detected in serum.

Rubella has an incubation period of 13–20 days, following which the characteristic features of rash and lymphadenopathy may appear. Among children, onset is abrupt, with the appearance of rash and constitutional symptoms usually mild or absent. The rash is at first discrete, and is in the form of pinpoint macular lesions. It appears first on the face and spreads rapidly to the trunk and then to the limbs. Lesions may coalesce, but the rash seldom lasts for more than 3 days; in many cases it is fleeting. Adults may experience a prodromal phase with such constitutional features as malaise or fever for a day or two before rash develops. At this time an erythematous pinpoint enanthem may be visible on the soft palate. The mechanism by which RV

induces rash has not been established. However, virus has been isolated from skin biopsy specimens taken from areas with and without rash, as well as from the skin of patients with subclinical infections, suggesting an immunopathological mechanism.

Lymphadenopathy, which may be tender, may be present for up to a week before onset of rash and may persist for 10–14 days after it has disappeared. Lymphadenopathy may be generalized, but the suboccipital, postauricular and cervical lymph nodes are affected most frequently.

Joint involvement represents the commonest complication of naturally acquired rubella as well as rubella vaccination, usually developing as the rash subsides. Although relatively uncommon among prepubertal females and males, it may occur in up to 50% of postpubertal females. Symptoms may vary in severity from a transient stiffness of the joints to an arthritis with pain, swelling and limitation of movement. This usually persists for 3–4 days, but may persist occasionally for up to a month. The finger joints, wrists, knees and ankles are most frequently affected. Arthralgia may be the result of direct viral invasion of the synovium, since virus has been isolated from joint aspirates of patients with naturally acquired rubella and vaccinees with vaccine-induced arthritis. *In vitro* studies have shown that wild-type and attenuated strains of rubella will replicate in human synovial membrane cell cultures. Immune mechanisms are more likely to be involved, however, for in addition to virus, high levels of rubella-specific IgG have been detected in joint aspirates, which suggests that joint symptoms may be mediated by immune complexes; indeed, the presence of immune complexes in the sera of vaccinees has been associated with a high incidence of joint symptoms. Hormonal factors may also be involved, since in addition to being commonest in postpubertal females, joint symptoms are most likely to develop within 7 days of the onset of the menstrual cycle in vaccinees. Although there have been studies which have reported that RV or its antigens have been detected in the synovial fluid or synovium of patients with rheumatoid arthritis and seronegative arthritis (rheumatoid factor negative), more recent studies have failed to confirm these findings, although RV has very occasionally been detected in both the synovial fluid and cells of patients with chronic joint disease, including some who were immunosuppressed (Bosma *et al.*, 1998).

Rubella is associated very rarely with other

complications, although a postinfectious encephalopathy may develop in about 1 in 5000–10000 cases within a week of onset of rash. In contrast with measles, the prognosis is usually good. The cerebrospinal fluid (CSF) usually contains cells, mostly lymphocytes, but CSF protein levels are normal. The encephalopathy, which may be immune mediated, since infectious virus or its nucleic acid by PCR has been detected only rarely (Wolinsky, 1996), is not associated with demyelination or inflammatory damage, which is present in other postinfectious encephalitis.

Thrombocytopenia is also a rare complication of rubella in which a purpuric rash, epistaxis, haematuria and gastrointestinal bleeding have been reported.

Rubella may present atypically with minimal lymphadenopathy and an evanescent rash. In up to 25% of cases infection is subclinical. Conversely, typical rubelliform rashes may result from infection by other viruses (e.g. enteroviruses). Infections by such viruses as the human parvovirus (B19) and some arboviruses (e.g. *Chikungunya virus* and *Ross River virus*) may cause both rubelliform rashes and arthralgia. Because clinical diagnosis is unreliable, it is essential that all women who have been exposed to, or develop rubella-like illnesses in pregnancy, be assessed virologically (p406); a past history of rubella without laboratory confirmation of the diagnosis must never be accepted as indicative of previous infection and consequent immunity.

The relationship between the clinical and virological features of infection is shown in Figure 12.5. Patients are potentially infectious over a prolonged period; pharyngeal excretion may be present for up to a week before the onset of rash, and for 7–10 days thereafter. Although virus may be recovered from the stools and urine, excretion from these sites is more transient. Such specimens are therefore less suitable for virus isolation and do not play an important role in the transmission of virus. Viraemia is present for about a week before the onset of rash, but, as rubella antibodies develop, viraemia ceases. The first antibodies to appear are those detected by HI and neutralization. IgG antibodies detected by enzyme immunoassay (EIA), complement fixation (CF) and single radial haemolysis (SRH) usually develop a few days later. Differing results have been obtained by the various workers who have examined IgG subclasses. Thomas and Morgan-Capner (1988) compared the

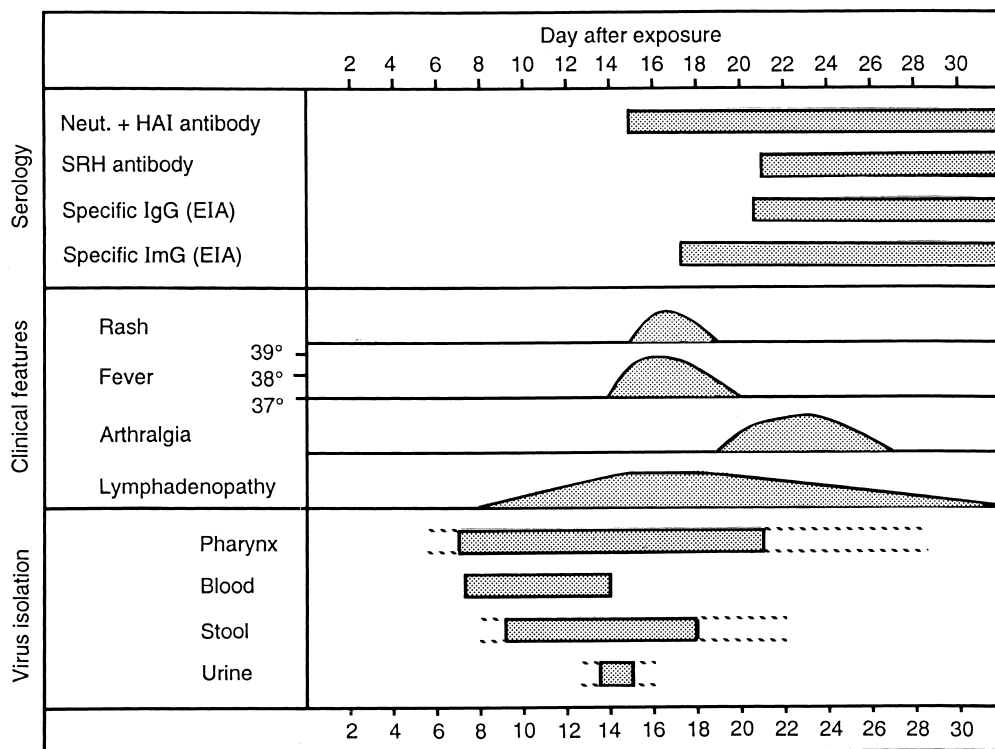

Figure 12.5 Relation between clinical and virological features of postnatally acquired rubella. (Reproduced with permission from Banatvala and Best, *Topley and Wilson*, 9th edition, Vol. 1)

use of different sources of rubella antigens in EIAs and reported IgG1 in all sera containing rubella antibodies detectable by SRH or latex agglutination (LA), and IgG3 in most sera from cases of recent naturally acquired rubella. IgG4 has been detected in sera from occasional cases of remote rubella.

Reinfection

Natural infection is followed by a very high order of protection from reinfection. However, evidence of reinfection, which is generally asymptomatic, may be obtained by demonstrating a significant increase in antibody concentration following natural and experimental exposure to rubella. Reinfection would provide a hazard to the fetus if it is associated with viraemia; this has only rarely been documented. It may be difficult to distinguish between primary infection and reinfection, particularly if blood was not obtained shortly after contact

or if sera taken prior to contact (e.g. for screening purposes) are not available (p 407).

Initial reports suggested that asymptomatic reinfection in early pregnancy was unlikely to be associated with fetal infection, even when a specific IgM response was detected. However, several well-documented cases have now been reported where RV was isolated from the products of conception or children with congenital rubella were born (Best *et al.*, 1989). Morgan-Capner *et al.* (1991) have calculated that the risk of fetal infection is approximately 8% following reinfection in the first 16 weeks of pregnancy, but fetal malformations are rare. Rubella reinfection is not associated with a lack of neutralizing antibodies or a specific defect in rubella specific lymphoproliferative responses (O'Shea *et al.*, 1994); but a failure to produce epitope-specific antibodies is possible. RV strains isolated from cases of reinfection do not appear to have sequence changes in the E1 ORF (Bosma *et al.*, 1996; Frey *et al.*, 1998). Reinfection following rubella vaccination is discussed on page 411.

CONGENITALLY ACQUIRED INFECTION

Pathogenesis

If acquired at an early gestational age, rubella is likely to induce a generalised and persistent fetal infection resulting in multisystem disease. More than 20 years have elapsed since Töndury and Smith (1966) conducted their classic histopathological studies which demonstrated the probable mechanism by which RV induces fetal damage. The earliest lesions are found in the placenta, which is almost certainly infected during the maternal viraemic phase. However, since rubella is also excreted via the cervix for at least 6 days after the onset of rash, and since it is possible that virus may multiply elsewhere in the genital tract following an acute infection, placental infection by direct contact from an ascending genital infection cannot be excluded. Töndury and Smith (1966) suggested that rubella enters the fetus via the chorion, since necrotic changes to the epithelial cells as well as in the endothelial lining of the blood vessels were present as early as the 10th day after maternal rash. Damaged endothelial cells may then be desquamated into the lumen of the vessel and transported into the fetal circulation in the form of virus-infected 'emboli', to infect the various fetal organs. Damage to fetal endothelial cells may be extensive, and is the result of viral replication rather than any immunopathological mechanism, since extensive lesions are present at an early gestational age before fetal immune mechanisms are sufficiently mature to be activated. The marked absence of any inflammatory cellular response following rubella during the early gestational period was characteristic. Anomalies were present in 68% of 57 fetuses when maternal rubella was contracted during the first trimester. Eighty per cent were abnormal when rubella was contracted during the first month of pregnancy, with sporadic foci of cellular damage in the heart, lens, inner ear, teeth and skeletal muscle. In addition to virus-induced tissue necrosis, RV induces a retardation in cell division, this being due to a rubella-specific protein which reduces the rate of mitosis in infected cells. If this occurs during the critical phase of organogenesis, the organs will contain fewer cells than those of uninfected infants, and multiple

developmental defects are likely to occur. Although the rubella-specific protein has yet to be identified, human embryonic cells persistently infected with rubella *in vitro* have an altered responsiveness to the growth-promoting properties of epidermal growth factor and a decreased capacity for the synthesis of collagen (Yoneda *et al.*, 1986). Additional damage to such malformed organs as the liver, myocardium and organ of Corti results from the damage caused to endothelial cells, which may result in haemorrhages in small blood vessels causing tissue necrosis over a prolonged time.

Virus or viral antigens can almost always be detected in the products of conception of virologically confirmed cases of maternal rubella during the first trimester. This demonstrates that the fetus is almost invariably infected regardless of when maternal infection occurred during this period. Should such pregnancies proceed to term, the rubella-infected infants would almost certainly be excreting rubella at birth and for some months thereafter. However, virus is isolated infrequently from neonates whose mothers acquired rubella after the first trimester, probably because fetal immune mechanisms can then be activated and effectively terminate infection. That fetal infection occurs following post-first trimester rubella, however, is apparent from the finding that serological evidence of fetal infection has been obtained in 25–33% of infants whose mothers acquired maternal rubella between weeks 16 and 28 of gestation (Cradock-Watson *et al.*, 1980).

Virus Persistence*

Following intrauterine infection in early pregnancy, RV persists throughout gestation and can be isolated from most organs obtained at autopsy from infants who die in early infancy with severe and generalised infections. Virus may also be recovered from the throat swabs, urine, stools, CSF and tears of survivors. RV can be isolated from nasopharyngeal secretions of most neonates with severe congenitally acquired disease, but by the age of 3 months the proportion excreting virus has declined to 50–60% and by 9–12 months to 10% (Figure 12.6) (Cooper and Krugman, 1967). Particu-

*Reproduced with permission from Banatvala and Best, *Topley and Wilson*, 9th edition, vol. 1.

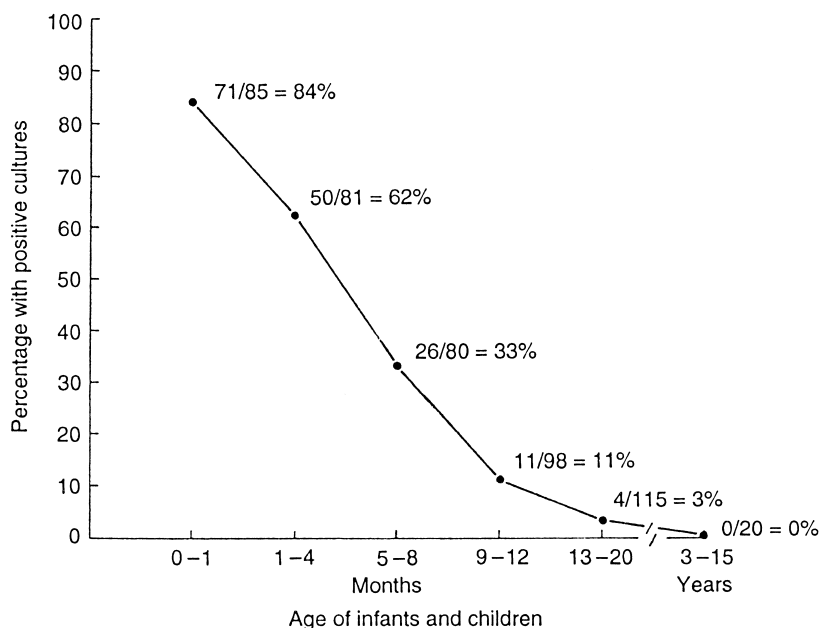

Figure 12.6 The frequency of virus excretion with age of infants with congenitally acquired rubella. (Reproduced with permission from Cooper and Krugman, 1967), *Arch. Ophthalmol.*, 77, 434. © 1967 American Medical Association)

larly during the first few weeks after birth, those with severe disease may excrete high concentrations of virus and readily transmit infection to rubella-susceptible contacts. RV may persist in infants with congenitally acquired disease in secluded sites for even longer. Thus, RV has been recovered from a cataract removed from a 3-year-old child (Menser *et al.*, 1967b) and detected by PCR in lens aspirates from children with CAR up to the age of 12 months (Bosma *et al.*, 1995a). RV has also been detected in the CSF of children with central nervous system (CNS) involvement up to the age of 18 months (Desmond *et al.*, 1967). By IF, rubella antigen was detected in the thyroid from a 5-year-old child with Hashimoto's disease (Ziring *et al.*, 1977), and by cocultivation techniques RV was recovered from the brain of a child who developed rubella panencephalitis at the age of 12 years (Cremer *et al.*, 1975; Weil *et al.*, 1975). Experimental studies have shown that, within the CNS, the astrocyte is the main cell type in which virus replicates, high levels of virus being expressed. Intrauterine infection involving these cells may perhaps induce focal areas of necrosis resulting in the pattern of neurological deficit observed in congenitally acquired disease (Chantler *et al.*, 1995).

The mechanism by which CAR may result in

insulin-dependent diabetes mellitus (IDDM) has not been established. However, an experimental study employing human fetal islet cells showed that RV induced a depression of immunoreactive secreted insulin without being cytolytic (Numazaki *et al.*, 1990). A further study suggested that autoimmune phenomena might be involved since it was shown that immunoreactive epitopes in the RV capsid shared antigenicity (molecular mimicry) with islet β cell protein (Karounos *et al.*, 1993).

The mechanism by which RV persists throughout gestation and for a limited period during the first year of life has not been clearly established. Possible mechanisms include defects in cell-mediated immunity, poor interferon synthesis and the possibility that a limited number of infected fetal cells give rise to infected clones which persist for a limited period (reviewed by Banatvala, 1977). It has also been suggested that selective immune tolerance to the RV E1 protein may play a role (Mauracher *et al.*, 1993). Studies *in vitro* show that RV replicates in T lymphocytes and macrophages and can also persist in B lymphocytes, causing inhibition of host-cell protein synthesis (Chantler and Tingle, 1980; van der Logt *et al.*, 1980). Infection of macrophages may interfere with their interactions with T cells. Postnatally acquired rubella causes a transient reduc-

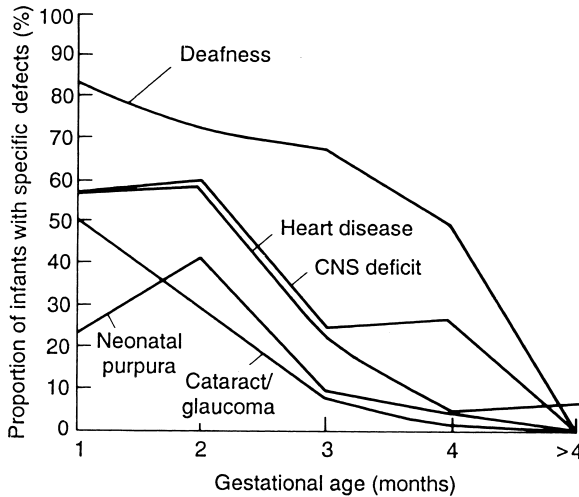

Figure 12.7 Relation of clinical manifestations of congenital rubella to time of maternal infection, extrapolated from Cooper *et al.* in the Proceedings of the International Conference on Rubella Immunization (1969). (Reproduced with permission from Banatvala and Best, *Topley and Wilson*, 9th edition, Vol. 1)

tion in lymphocyte responses to phytohaemagglutinin (Maller *et al.*, 1978; Buimovici-Klein *et al.*, 1979; Vesikari, 1980) as well as a decrease in the numbers of T cells (Niwa and Kanoh, 1979). CAR might be expected to cause an even greater reduction in responsiveness. Indeed, significantly diminished lymphoproliferative responses to phytohaemagglutinin and rubella antigen, as well as diminished interferon synthesis, have been demonstrated in 40 congenitally infected children aged 1–12 years (Buimovici-Klein *et al.*, 1979). Impairment of cell-mediated immune responses was related to the gestational age at which maternal infection occurred, and was greatest in infants whose mothers acquired rubella in the first 8 weeks of pregnancy. Hosking and colleagues (1983) suggested that children with nerve deafness due to CAR could be distinguished from those with immunity due to postnatally acquired rubella by their failure to produce lymphoproliferative responses to rubella antigen. We have also found that 10 of 13 (80%) children with CAR under the age of 3 years failed to mount a lymphoproliferative response (O'Shea *et al.*, 1992). Congenitally infected infants have also been shown to have impaired natural killer cell activity and persistent T cell abnormalities. It is of interest that the defective cell-mediated immune responses may persist into the second decade of life,

well beyond the time when RV can be recovered from accessible sites.

Risks to the Fetus

Maternal Rubella in the First Trimester

Maternal rubella may result in fetal death and spontaneous abortion, or the delivery of a severely malformed infant, or an infant with minimal damage or a healthy infant. The outcome depends on a combination of factors. These include the level of maternal viraemia, perhaps the genetic susceptibility of fetal cells to rubella infection, but most importantly the gestational age at which maternal infection occurs.

Studies which have included virological confirmation of the diagnoses of maternal rubella and congenital rubella suggest that the incidence of defects following maternal infection in the first trimester is at least 80–85%, much higher than had hitherto been realized (reviewed by Wolinsky, 1996). If maternal rubella is acquired during the first 8 weeks of pregnancy, spontaneous abortion may occur in up to 20% of cases. Figure 12.7 relates the type of rubella-induced congenital anomaly to the gestational age at which infection occurred among 376 infants infected *in utero* during the 1964 USA epidemic. Cardiac and eye defects are likely to result when maternal infection is acquired during the critical phase of organogenesis, in the first 8 weeks of pregnancy, whereas retinopathy and hearing defects are more evenly distributed throughout the first 16 weeks of gestation.

Risk of Maternal Rubella After the First Trimester

Rubella virus is seldom isolated from infants whose mothers acquired rubella after the first trimester, although *in vitro* studies have shown that fetal tissues, regardless of gestational age, are susceptible to infection. Indeed, serological studies confirm that a high proportion of infants are infected following maternal post-first trimester rubella, rubella-specific IgM being detected in 25–33% of infants whose mothers had rubella between the 16th and 20th weeks of pregnancy (Cradock-Watson *et al.*, 1980). However, because organogenesis is complete by 12 weeks, and in more mature fetuses immune re-

Table 12.2 Incidence of rubella-induced defects in infants infected *in utero* after the first trimester

Reference	Gestational age (weeks)		
	13–16	17–20	> 20
Peckham (1972) ^a	7/73 (10)	4/40 (10)	1/11 (9.1)
Vejtorp and Mansa (1980) ^b	0/4	1/14 (7)	1/16 (6.2)
Miller <i>et al.</i> (1982)	9/26 (35)	0/10	0/53
Grillner <i>et al.</i> (1983)	4/17 (23)	2 ^c /54 (3.7)	0/35
Total	20/120 (16.7)	7/118 (5.9)	2/115 (1.7)

Values in parentheses are percentages.

^a These children were normal at birth.

^b Children followed up for 6 months only.

^c One additional case of deafness reported since 1983.

Reproduced from L. Collier and M. Timbury (eds) (1990) *Topley and Wilson's Principles of Bacteriology, Virology and Immunity* 8th edition by permission of Edward Arnold/Hodder & Stoughton Educational.

sponses may limit or terminate infection, such infants rarely have severe or multiple anomalies. The results of four studies conducted in different countries are shown in Table 12.2. Most surveys have shown that deafness and retinopathy, which *per se* does not affect vision, are likely to be the only anomalies commonly associated with post-first trimester rubella (reviewed by Banatvala and Best, 1998). Figure 12.7 shows that deafness is usually the sole clinical manifestation of fetal infection occurring between 13 and 16 weeks, and is relatively common, but deafness or any other defect is only rarely encountered after this time. These findings emphasize the importance of conducting careful follow-up studies on infants with serological evidence of intrauterine infection as a result of maternal infection occurring between 13 and 16 weeks, particular importance being directed towards the recognition of hearing defects.

Risks of Preconceptual Rubella

If conception occurs shortly after the appearance of rash there should be little risk of the conceptus being infected, because the development of the rash coincides with the immune response and the termination of viraemia. However, because RV may persist after the onset of rash elsewhere, for example in the genital tract, infection of the conceptus via this route is a possibility. Although six case reports were found prior to 1984 in which maternal infection occurring as long as 21 days before conception apparently resulted in intrauterine infection, it is encouraging that more recent studies conducted in Germany and

Britain indicate that preconceptual rubella does not result in transmission of RV to the fetus. Thus, there was no serological or clinical evidence of intrauterine infection in 38 infants whose mothers' rash appeared before or within 11 days after their last menstrual period (LMP). However, an interval of 12 days between LMP and rash resulted in fetal infection and all of 10 mothers who developed rash 3–6 weeks after their LMP transmitted infection to their fetuses (Enders *et al.*, 1988).

Clinical Features

The frequency and importance of congenital defects involving the heart, eyes and ears were emphasised in the early retrospective as well as in most prospective studies. However, following the extensive 1963–1964 epidemic in the USA, as well as in subsequent epidemics in other parts of the world, a much broader range of rubella-induced congenital anomalies was observed. This phenomenon is more likely to be due to more careful and prolonged observation than to any change in the biological behaviour or teratogenic potential of the virus. Thus, careful examination of the case notes of infants with congenitally acquired disease who were born before this outbreak showed that such anomalies as thrombocytopenic purpura and osteitis occurred fairly frequently, even though not recorded in the literature. In addition, careful and prolonged follow-up studies showed that CAR was not a static disease, since some features of in-

Table 12.3 Clinical features associated with congenitally acquired rubella

Transient	Developmental	Permanent
<i>Common</i>		
Low birthweight	Sensorineural deafness	Sensorineural deafness
Thrombocytopenic purpura	Peripheral pulmonary stenosis	Peripheral pulmonary stenosis
Hepatosplenomegaly	Mental retardation	Pulmonary valvular stenosis
Bone lesions	Central language defects	Patent ductus arteriosus
Meningoencephalitis	Diabetes mellitus	Ventricular septal defect
		Retinopathy
		Cataract
		Microphthalmia
		Psychomotor retardation
		Microcephaly
		Cryptorchidism
		Inguinal hernia
		Diabetes mellitus
<i>Uncommon</i>		
Cloudy cornea	Severe myopia	Severe myopia
Hepatitis	Thyroiditis	Thyroid disorders
Generalized lymphadenopathy	Hypothyroidism	Dermatoglyptic abnormalities
Haemolytic anaemia	Growth hormone deficiency	Glaucoma
Pneumonitis	'Late onset disease'	Myocardial abnormalities

Adapted with permission from Banatvala and Best, *Topley and Wilson*, 9th Edition, Vol. 1.

trauterine infection might not be apparent for months or indeed years (e.g. perceptible deafness, IDDM).

Clinical features of the congenital rubella syndrome (CRS) have been reviewed by Cooper (1975), who categorized them into transient, developmental or permanent (Table 12.3).

Transient Anomalies

Transient anomalies usually present during the first few weeks of life, do not recur and are not associated with permanent sequelae. Their pathogenesis has not been established, but such features as intrauterine growth retardation (small-for-dates babies), thrombocytopenic purpura (Figure 12.8), hepatosplenomegaly and haemolytic anaemia are common. About 60% of infected infants fall below the 10th, and 90% below the 50th, growth percentile. The above features, which often result from infection acquired at an early gestational age, seldom occur without such other manifestations of congenital disease as heart and eye defects, and reflect extensive infection which may result in high perinatal mortality rates. Infants with thrombocytopenic purpura have platelet counts ranging from 3 to $100 \times 10^9 \text{ l}^{-1}$ (normal = $310 \pm 68 \times 10^9 \text{ l}^{-1}$). This is associated with a decrease in

the number of megakaryocytes in the bone marrow, although they are morphologically normal. If severely affected infants survive, their platelet count rises spontaneously during the first few weeks of life; rarely, infants may die from such complications of thrombocytopenia as intracranial haemorrhage.

Bony lesions may be present in about 20% of congenitally infected infants. The metaphyseal portions of the long bones are usually involved and radiologically appear as areas of translucency. These lesions, which are due to a disturbance in bone growth rather than an inflammatory response, usually resolve without residual sequelae within the first 1–2 months of age.

About 25% of infants who present at birth with clinical manifestations of CAR also have CNS involvement, this usually being in the form of meningoencephalitis. At birth, these infants may be either irritable or lethargic with a full fontanelle and CSF changes consistent with a meningoencephalitis. Although about 25% of infants presenting at birth with a severe neonatal encephalitis may, by the age of 18 months, be severely retarded and have communication problems, ataxia or spastic diplegia, some infants progress well neurologically despite poor development during their first few months of life. Although RV has been recovered from the brain and from patients' lymphocytes, it is



Figure 12.8 Purpuric rash in newborn infant with congenitally acquired rubella, who was subsequently found to have congenital heart disease and cataract. (Reproduced with permission from Banatvala and Best, *Topley and Wilson*, 9th edition, Vol. 1)

possible that this manifestation of congenital rubella may be autoimmune in nature, triggered possibly by molecular mimicry between viral and host epitopes.

Developmental Defects

Developmental defects may take months or years before becoming apparent, but persist indefinitely. Failure to recognise them may not merely be the result of difficulty in their detection, for there is evidence to show that such defects as perceptive deafness, some CNS anomalies and some ocular defects may actually develop or become progressively more severe. Thus, audiological examination has shown that some infants, although having apparently normal hearing at 9–12 months of age, are found to have severe sensorineural deafness a few months later. Rubella-induced deafness may be unilateral with no characteristic audiometric pattern. Prior to the introduction of vaccination programmes, congenitally acquired rubella probably represented the commonest cause of congenital deafness in most developed countries, its impact

being insufficiently appreciated since there may have been no history of maternal rubella. Deafness may be the only anomaly present, particularly if maternal infection occurred after the first trimester. Thus, in a study on a large number of children aged 6 months to 4 years who attended the Nuffield Hearing and Speech Centre in London, it was estimated that about 15% of all cases of sensorineural deafness were the result of CAR. IDDM (juvenile-onset; type 1) is the most frequent endocrine disorder among children with congenital rubella (reviewed in Burke *et al.*, 1985). It was thought originally to be a rare complication of congenital rubella, but it is now recognised that clinical manifestations may be delayed until adolescence or adult life. A follow-up study of patients in New South Wales who were born with CAR in the 1940s showed that 20% had developed eventually IDDM. Follow-up studies in New York on children, most of whom were infected *in utero* during the 1963–1964 epidemic, have shown that 30 of 242 (12.4%) had developed IDDM. The mean age of children developing IDDM in this US study was 9 years, while all of the Australian patients were in their 20s (reviewed by Banatvala and Best, 1990). Lymphocytic infiltration of the pancreas of an infant with CAR but without IDDM may suggest that RV can initiate the train of events which subsequently results in IDDM in later life. However, it seems probable that autoimmune mechanisms are involved in the pathogenesis since the HLA types in these patients are typical of those with autoimmune disease, there being a significant increase in prevalence of HLA-DR2. In addition, islet cell antibodies have been detected in 20% of these patients. These antibodies have a cytotoxic effect on cultured islet cells and predict the diabetic state. Although autoimmune responses may play an important role, the mechanism by which RV may trigger them remains to be established. Possible mechanisms have been reviewed by Banatvala (1987).

Central Nervous System

The progressive nature of congenitally acquired rubella is emphasised by reports that occasionally children with previously clinically stable congenitally acquired disease may develop a widespread subacute panencephalitis. Ten cases have been reported in patients with congenital rubella, and two following postnatally acquired infection. All but

one of the patients were male and clinical features developed between the ages of 8 and 19. Clinical and laboratory features are analogous to measles-induced subacute sclerosing panencephalitis, since, in addition to intellectual deterioration, spasticity and ataxia occur. Histological studies revealed a panencephalitis with a perivascular inflammatory response as well as a vasculitis. RV has been isolated from the brains of such patients and has also been recovered from their lymphocytes. Rubella antigens have not been detected by immunofluorescence in sections of brain. High levels of rubella-specific IgG and, occasionally, IgM may be present in the serum, while in the CSF there are elevated levels of protein and immunoglobulin, and oligoclonal bands are found. There is also a high CSF:serum rubella antibody titre ratio. It has been postulated that post-rubella panencephalitis may be a disease mediated by immune complexes or by RV-mediated autoreactivity to brain antigens.

Late Onset Disease

Between the ages of about 3 and 12 months, some congenitally infected infants may develop a chronic rubella-like rash, persistent diarrhoea and pneumonitis, which is referred to as 'late onset disease'. Mortality is high, but some infants improve dramatically if treated with corticosteroids. Circulating immune complexes are probably responsible for inducing this syndrome (reviewed by Hanshaw *et al.*, 1985).

Permanent Defects

Among the permanent defects and in addition to damage to the organ of Corti which may be present at birth, cardiovascular and ocular anomalies provide the greatest problems.

Cardiac Defects

Cardiac defects are responsible for much of the high perinatal mortality associated with CAR, the commonest lesions being the persistence of patent ductus arteriosus, proximal (valvular) or peripheral pulmonary artery stenosis or a ventricular septal defect. In association with such anomalies, a neonatal myocarditis may occasionally occur. RV may also damage the intimal lining of the arteries and this may cause obstructive lesions of the pul-

monary and renal arteries.

Ocular Defects

Most of the classical ocular defects which occur in CAR were described by Gregg (1941), who drew particular attention to the pigmented retinopathy and cataract. Although usually present at birth, cataracts may not be visible until several weeks later. They are unilateral in about 50% of patients, and may be subtotal, consisting of a dense pearly-white central opacity (Figure 12.9), or total, with a more uniform density throughout the lens. Microphthalmia may be present in eyes with cataract. Glaucoma occurs much less frequently than cataract, but glaucoma and cataract do not seem to be present in the same eye. Retinopathy is present in about 50% of congenitally infected infants and its presence may provide a useful clinical diagnostic marker. Retinopathy is not the result of an inflammatory response but is due to a defect in pigmentation and usually involves the macular areas. Hyperpigmented and hypopigmented areas give the retina a 'salt and pepper' appearance. Chronic uveitis, choroidal neovascularization, corneal hydrops and keratoconus have also been described. The mechanisms involved may include damage induced by viral persistence causing reduced cell growth rate and lifespan, virally induced vascular damage or autoimmune phenomena (reviewed by Arnold *et al.*, 1994).

Outlook for Children with Congenital Rubella

As a result of the extent and severity of rubella-induced congenital malformations, any surviving children require continuous and specialized medical care, rehabilitation and education. However, assessment of 25-year-old patients whose mothers acquired rubella during the extensive epidemic in Australia in the early 1940s showed that many had developed far better than had been anticipated in early childhood, despite the presence of hearing and eye defects. Most were of average intelligence, employed, and some had married and had normal children (Menser *et al.*, 1967a). In contrast, studies on children with CAR resulting from the 1963–1964 US epidemic showed that they had fared less favourably (Cooper, 1975). This difference is probably due to the survival of children with some of the



Figure 12.9 Congenital rubella cataract in a 9-month-old infant. Cataract was also present in the left eye but was removed surgically. (Reproduced with permission from Banatvala and Best, *Topley and Wilson*, 7th edition, Vol. 4)

more severe manifestations of congenital infection, which reflects more modern, vigorous and sophisticated methods of treatment which were not available previously.

LABORATORY TECHNIQUES AND DIAGNOSIS

Serological Assessment of Women Exposed to or Developing Rubella-like Illnesses in Pregnancy

It is essential that, before attempting to interpret serological results on sera from women who have been exposed to or who have developed rubella-like illness in pregnancy, accurate information is obtained relating to date and duration of exposure, date of onset of illness, including presence and distribution of rash, lymphadenopathy and arthralgia. A history of rubella vaccination as well as results of previous rubella antibody screening tests, together with the techniques by which they were carried out, are also relevant.

Blood should be collected from pregnant women with features of a rubella-like illness as soon as possible after onset of symptoms. A significant rise in antibody titre can often be detected within 7 days, although occasionally the response may be delayed,

in which case it may be necessary to test additional blood samples at intervals of 3–4 days. Although HI antibodies may be present during the acute phase of the illness, antibodies detected by SRH, and the IgG response detectable by EIA, may be delayed (Figure 12.5). The absence of rubella antibody by such tests but their presence by HI may be suggestive of recently acquired infection. Tests for rubella-specific IgM should also be carried out. This investigation is also of value when patients present in the postacute phase of their illness, at which time antibody levels may already have reached their maximum levels. It is important to stress that, regardless of technique employed, no particular titre of antibody can be regarded as indicative of recent or current infection. Although the presence of rubella-specific IgM used to be considered indicative of a recent primary infection, it is now recognised that, if sensitive techniques are employed, low and transient concentrations of rubella-specific IgM may be detected in reinfection, and low levels may persist for periods ranging from a few months to up to 4 years following rubella vaccination (reviewed in Burke *et al.*, 1985). Such findings emphasize the importance of assessing clinical and serological data carefully before making a diagnosis of primary rubella infection, the consequences of which may result in termination of a precious pregnancy.

Women who give a history of exposure to a rubella-like illness are much more likely to acquire infection if exposure is close and prolonged; for example, within their own household, or, in the case of a school teacher, to children in class. Although rubella contacts may give a history of rubella vaccination or have been found to have rubella antibodies when screened during a previous pregnancy, it is still advisable to investigate such persons serologically if they have been exposed recently to rubella-like illness. Thus, some vaccinees may fail to develop an immune response following rubella vaccination (p 411) and very occasionally the result of a screening test may be recorded incorrectly. In addition, rubella screening, if carried out by HI, may be unreliable, giving rise to false-positive results (p 406). Blood should be obtained from pregnant women for rubella antibody screening when they first book in at antenatal clinics. It is advisable to store these specimens until, say, 2–3 months after delivery. Thus, if a patient subsequently gives a history of exposure to rubella, this pre-exposure specimen can be tested in parallel with postex-

posure serum samples. In addition, should an infant be delivered with clinical features compatible with an intrauterine infection, serum obtained in early pregnancy can be tested in parallel with that obtained after delivery and the infant's cord or neonatal blood. Tests may be carried out for evidence of congenital infection, not only by rubella but also by such organisms as cytomegalovirus and *Toxo-plasma gondii*.

If a history of exposure to a rubella-like illness is given prior to attendance at the first antenatal clinic, or if no earlier blood sample is available, it is important that blood be obtained as soon as possible after contact. The presence of antibodies in such a sample suggests that any antibody present is longstanding, resulting from infection in the past, provided that the sample was obtained well within the incubation period of rubella (e.g. within 10–14 days of last exposure). Nevertheless, it is advisable to collect more blood in 7–10 days, to ensure that there is no change in rubella antibody concentration. Patients who present for virological investigations some time after exposure to possible rubella are more difficult to assess, since it cannot be determined whether antibody is longstanding or the result of recently acquired infection. This can be established, however, by testing sera for rubella-specific IgM. Women who are seronegative should be followed up for 1 month after the date of the last contact to ensure that seroconversion does not occur. Many of these women experience considerable anxiety during this period, which may be allayed by conducting serological investigations on the index case to determine whether or not the infection was indeed rubella. Patients who have been followed up but who remain seronegative should be offered rubella vaccination post partum.

Serological Techniques Used for Rubella Antibody Screening

Extensive rubella antibody screening of adult women is carried out in order to identify susceptibles who require vaccination. EIA, SRH and LA are the techniques used most frequently for screening purposes. HI is not recommended since it is time consuming and labour intensive, and false-positive results may occur, this being due to failure to remove all serum lipoprotein inhibitors from test

sera (PHLS Working Party on the Laboratory Diagnosis of Rubella, 1988).

Many tests for rubella antibody screening are available commercially. EIAs are now used widely because they are readily automated and can be used in automated antenatal screening. LA has the advantage of providing a result within a few minutes and may be used to confirm negative results. SRH is still used in some UK laboratories, commercially available reagents being used to prepare plates in the laboratory. These techniques have been described in detail by Best and O'Shea (1995). Vaccination should be offered to women with antibody concentrations $< 10\text{--}12 \text{ iu ml}^{-1}$ (Skendzel, 1996) and this is the cut-off in most commercial assays. Negative results should be confirmed using a different assay in order to identify sampling errors and avoid the occasional false negative results obtained in automated assays. Some women fail to produce antibody levels $> 15 \text{ iu ml}^{-1}$ by SRH even after several vaccinations. Many laboratories therefore consider women with a well-documented history of more than one vaccination to be immune, if antibodies are detectable by two reliable assays.

Rubella-specific IgG antibodies have been detected in saliva by IgG capture radioimmunoassay (GACRIA) (Perry *et al.*, 1993). Thus, saliva may be used instead of serum for rubella antibody screening and seroepidemiological studies, especially those involving children and in developing countries (Eckstein *et al.*, 1996).

Serological Techniques Used for Diagnosis

Detection of Rubella-specific IgM

Serological methods are used for the diagnosis of rubella acquired postnatally, since RV is slow to grow and difficult to identify in cell cultures. A diagnosis is usually made by detection of rubella-specific IgM, but in the case of a pregnant woman it is advisable to confirm that diagnosis by demonstrating a rise in specific IgG concentration or by detecting specific IgM in a second serum. Rubella-specific IgM may be detected by commercial EIAs. The M-antibody capture format is generally preferred to indirect assays, for which serum pretreatment is required owing to the possibility of false-positive results due to IgM antiglobulins, such as rheuma-

toid factor. Care should be taken to ensure that the test employed has a high level of sensitivity and specificity. The performance of commercial assays may differ, but it is possible usually to detect specific IgM antibodies within 4 days of onset of rash and for 4–8 weeks thereafter.

Detection of a Significant Rise in Antibody Titres

A significant rise in antibody titre can be detected by a quantitative EIA, HI or LA titration. Seroconversion can be detected by SRH. Although HI antibodies may develop 1–2 days after onset of symptoms, IgG antibodies detected by EIA, LA or SRH may be delayed until 7–8 days.

Use of Saliva

Rubella-specific IgG and IgM antibodies may be detected in saliva using antibody capture immunoassays and results correlate well with serum antibodies (Perry *et al.*, 1993). The optimum time for detecting specific IgM is 1–5 weeks after onset of illness. Using saliva, it has been possible to demonstrate that rubella-like illnesses in children under 1 year of age are due to other viruses, such as *Human herpesvirus 6* (see Chapter 2E).

Diagnosis of Reinfection

Rubella reinfection may be diagnosed by a significant rise in rubella IgG concentrations, sometimes to very high levels, or detection of specific IgM in a patient with pre-existing antibodies. If serum samples obtained before reinfection are not available for retesting, evidence of pre-existing antibody may be accepted if there are at least two laboratory reports of antibodies $> 10 \text{ iu ml}^{-1}$ obtained by a reliable technique (not HI). A documented history of rubella vaccination followed by at least one test for rubella antibodies $> 10 \text{ iu ml}^{-1}$ is also acceptable (Best *et al.*, 1989). The rubella-specific IgM response is usually lower and more transient than following primary infection.

It is often possible to distinguish reinfection from primary infection by examining the antigen-binding avidity of specific IgG. Sera taken from cases of recent primary rubella reinfection have low IgG avidity, while sera taken from persons with distant infection, including cases of rubella reinfection, have

higher avidity (Thomas and Morgan-Capner, 1990).

Detection of *Rubella virus*

Rubella virus may be detected in clinical samples by isolation in cell culture or by reverse transcription nested PCR (RT-nPCR), but these techniques are only available in specialized laboratories. RT-nPCR is of value for postnatal and prenatal diagnosis of congenital rubella (see below) and has been described in detail by Bosma *et al.* (1995a, 1995b) and Revello *et al.* (1997).

Rubella virus can be identified by cytopathic effect in RK13 or certain sublines of Vero cells (reviewed by Best and O'Shea, 1995; Banatvala and Best, 1998). In our experience, the technique of choice is two passages in Vero cells and a third passage in RK13 cells in which RV can be detected by indirect immunofluorescence (Figure 12.10). Alternatively, RT-nPCR can be used to identify virus after two passages in Vero cells.

Virological Diagnosis of Congenitally Acquired Infection

Postnatal Diagnosis

The diagnosis of CAR may be made by:

1. Detection of rubella-specific IgM in cord blood or serum samples taken in infancy;
2. Detection of a persistent rubella antibody response in the infant (i.e. presence of rubella antibody at a time beyond which maternal antibody would normally have disappeared, this being approximately 6 months of age);
and/or
3. Detection of RV in samples (such as throat swabs) from infected infants during the first few months of life. Virus may be detected by isolation in cell culture, or more rapidly by RT-nPCR. Specimens can be sent on dry ice or in formal saline for RT-nPCR in a distant laboratory. This has been used in our laboratory to test lens aspirates and to confirm the diagnosis of congenital rubella in children in India (Bosma *et al.*, 1995a, 1995b).

The National Congenital Surveillance Programme in the UK classifies suspected cases of

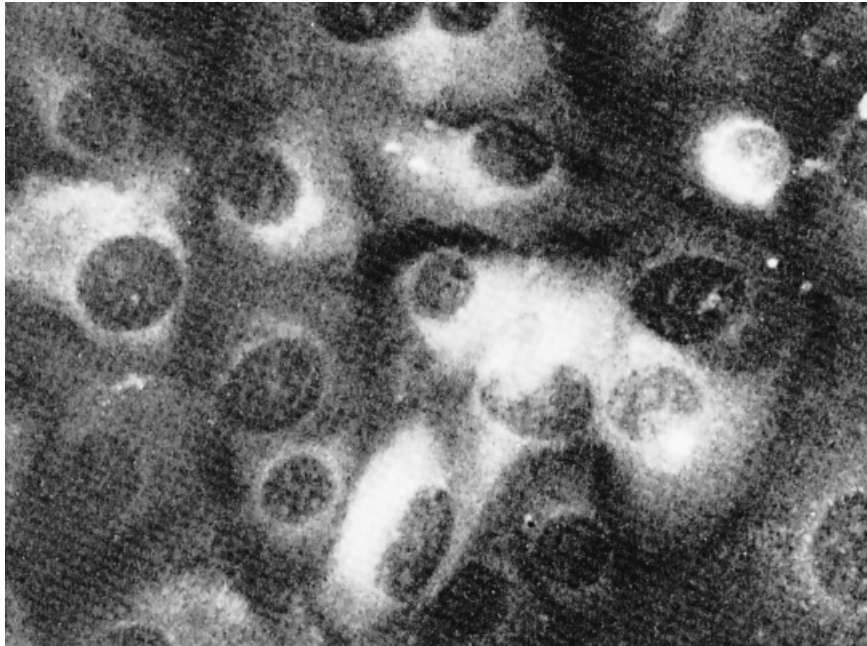

Figure 12.10 *Rubella virus* detected in RK13 cell cultures by immunofluorescence. Note cytoplasmic and perinuclear fluorescence. (Reproduced with permission from Banatvala and Best, *Topley and Wilson*, 7th edition, Vol. 4)

congenital rubella according to the criteria shown in Table 12.4.

Maternally derived rubella-specific IgG antibodies as well as specific IgG and IgM antibodies synthesized by the fetus *in utero* are present at birth. The detection of rubella-specific IgM in cord, neonatal or infant sera by an M-antibody capture assay is the method of choice for the diagnosis of CAR. If other IgM assays are used, rubella-specific IgM may not always be detected at birth and further serum samples should be tested if indicated. Specific IgM has been detected by M-antibody capture RIA in all confirmed cases to the age of 3 months, 86% of infants aged 3–6 months, 62% of infants aged between 6 months and 1 year, 42% children aged between 1 year and 18 months, but rarely in children over 18 months of age (Chantler *et al.*, 1982). The absence of specific IgM by M-antibody capture assays in the neonatal period virtually excludes symptomatic congenital rubella. If a low or equivocal result is obtained by any assay, a further specimen of serum should be examined. If the IgM result is negative or equivocal where there is a history of rubella in pregnancy and the baby is asymptomatic, a specimen of serum can be taken at approximately 9–12 months of age to examine for persistence of specific IgG.

Table 12.4 Congenital rubella: case classification criteria

<i>Congenital rubella infection</i>	
	No rubella defects but congenital infection confirmed by isolation of virus, or detection of specific IgM or persistent IgG in infant
<i>Congenital rubella syndrome</i>	
Confirmed	Typical rubella defect(s) plus virus-specific IgM or persistent IgG in infant; or two or more rubella defects plus confirmed maternal infection in pregnancy
Compatible	Two or more rubella defects with inconclusive laboratory data; or single rubella defect plus confirmed maternal infection in pregnancy
Possible	Compatible clinical findings with inconclusive laboratory data, e.g. single defect plus probable maternal infection in pregnancy
Unclassified	Insufficient information to confirm or exclude

Reproduced from Miller *et al.* (1994) with permission of the PHLS Communicable Disease Surveillance Centre ©PHLS, and from Banatvala and Best, *Topley and Wilson*, 9th edition, Vol. 1.

The detection of specific IgG may be of value for the diagnosis of congenital infection when tests for specific IgM have not been conducted in early infancy. Since rubella is uncommon under the age of 2 years, specific IgG detected between the ages of 1 and 2 may be suggestive of congenital rubella. However, each case must be assessed individually,

taking into account such factors as age, maternal history, presence of clinical findings suggestive of, or compatible with, congenital rubella, and rubelliform illnesses since birth. Detection of low avidity IgG1 may also assist the diagnosis in children up to the age of 3 years, as the avidity matures more slowly in children with congenital rubella than following postnatal infection (Thomas *et al.*, 1993). Rubella-specific lymphoproliferative assays may also help to provide a retrospective diagnosis of CAR in children between the ages of 1 and 3 (O'Shea *et al.*, 1992). Although rubella-specific IgG detected by SRH and EIA may persist indefinitely, studies on 223 children with congenital rubella following the 1963–1964 US epidemic showed that the HAI antibodies declined more rapidly among congenitally-infected children than among their mothers; by the age of 5, 20% of infants with congenital rubella no longer had HI antibodies. Nevertheless, seronegative children failed to develop an HI response or excrete virus when challenged with an attenuated vaccine. More recent studies suggest a decreased production of antibodies to the epitopes on the E1 glycoprotein, which induce HI antibodies, in some children with congenital rubella. In order to determine the immune status of such children in later life it may be necessary to test sera by EIA, LA or immunoblotting.

As discussed on page 398 and shown in Figure 12.6, RV may be recovered from throat swabs from most neonates with severe CAR which results from maternal infection in the first trimester, but by the age of about 3 months the proportion excreting virus has declined to 50–60%. Those with severe disease, particularly during the first few weeks after birth, often excrete high titres of virus and may readily transmit infection to rubella-susceptible persons. Women of childbearing age, some of whom may be in early stages of pregnancy, must be dissuaded from visiting such infants unless they have had rubella vaccine or serological tests confirm that they are immune. It is important that midwives and nursing staff who may have to care for such infants are also shown to be immune to rubella; it must be appreciated that midwives and nurses who originate from certain tropical countries may be more likely to be susceptible to rubella, as they may not have been offered rubella vaccination (p 395).

Prenatal Diagnosis

Prenatal diagnosis of suspected congenital infection is of value when the mother is reluctant to have therapeutic abortion following rubella in the first trimester, when maternal infection has occurred after the first trimester, in cases of possible maternal reinfection and where equivocal serological results were obtained, such as when the mother presents some time after a rubella-like illness.

The method of choice for prenatal diagnosis is the detection of rubella RNA in amniotic fluid by RT-nPCR, which has a sensitivity of 87–100% (Revello *et al.*, 1997; G. Enders and D. Dirmeier, 1998, personal communication). Amniotic fluid should be taken ≥ 8 weeks after onset of maternal rubella infection; however, as false-negative results may be obtained occasionally if the sample is taken too early, it may sometimes be necessary to test a second sample at 22–23 weeks gestation. Viral RNA may also be detected in fetal blood. Detection of virus in chorionic villus biopsies should be interpreted with caution, as the detection of RV in the placenta may not always reflect fetal infection (Bosma *et al.*, 1995a). When RT-nPCR is used a result can be available within 48 hours.

A prenatal diagnosis may also be made by testing fetal blood obtained by cordocentesis for rubella-specific IgM. Although rubella-specific IgM may be detected in fetal blood following infection in early pregnancy, the fetus may not produce sufficient IgM before the 22nd week of gestation. Even at 23 weeks gestation false negative results may be obtained, as concentrations of fetal rubella-specific IgM may be too low to be detected by available techniques; thus, it is advised to test fetal blood for rubella-specific IgM by more than one assay. This approach has the disadvantage that patients may have to wait for what might be an unacceptably long time for a diagnosis to be established, with little time for termination to be considered.

PREVENTION—RUBELLA VACCINATION

Development and Use of Attenuated Vaccines

The first attenuated strain of RV was developed at the National Institutes of Health in the USA by

passage in VMK cells of a virus isolated from a military recruit with rubella. Seventy-seven passages resulted in the strain being attenuated (HPV77) and preliminary trials in primates showed that the attenuated strain was well tolerated, induced an immune response and, following challenge, was protective. Prior to testing in institutionalized children, five further passages in duck embryo cultures were carried out to give HPV77-DE5 and this vaccine was also shown to be well tolerated, immunogenic and protective.

Further vaccine strains were prepared, being attenuated in primary rabbit kidney (Cendehill) and in human diploid cell cultures (RA27/3). The latter vaccine strain was originally isolated from the fetal kidney of a rubella-infected conceptus and is now the most widely used vaccine worldwide, although the Japanese use attenuated strains developed in their own country. The development and use of rubella vaccines has been reviewed (Best, 1991).

Immune Responses

About 95% of vaccinees develop an immune response some 20–28 days after vaccination, although occasionally it may be delayed for up to 2 months.

Failure to respond may result from not complying with the manufacturer's instructions during storage or following reconstitution (with consequent inactivation of virus or loss of potency), or pre-existing low levels of antibody. Passively acquired antibody via blood transfusion or administration of human immunoglobulin may suppress the replication of attenuated rubella vaccines. It is therefore advisable to avoid the administration of such live vaccines as rubella for a period of 3 months following transfusion or administration of immunoglobulins.

Antibody responses are directed towards all three major structural proteins (E1, E2 and C) and rubella-specific IgG and IgA responses can be detected; virus-specific IgM is present in about 70% of vaccinees and may persist for about 6 months, although occasionally for periods which may extend to 4 years (O'Shea *et al.*, 1985). Rubella-specific 7S IgA responses persist for up to 10–12 years but the oligomeric 10S response is transient. The RA27/3 vaccine induces a secretory IgA response which can be detected in nasopharyngeal secretions for up to 5

years after vaccination.

Serum antibodies are long lasting and will usually provide lifelong protection. Thus, antibodies detected by HI and SRH have been shown to persist for at least 21 years, although in about 10% of vaccinees they decline to low ($< 15 \text{ miu ml}^{-1}$) or even undetectable levels within 5 years. Nevertheless, when 19 volunteers with low or undetectable antibody levels were challenged intranasally with high titre RA27/3, only one was viraemic, this being transient and at a low level (O'Shea *et al.*, 1983). Lymphoproliferative responses are difficult to detect after vaccination (Buimovici-Klein and Cooper, 1985).

Virus Excretion

Provided sensitive assays are used, RV may be detected in the nasopharyngeal secretions of virtually all vaccinees 6–29 days after vaccination. Vaccine strains may also be detected in the breast milk of lactating women. However, vaccine strains are not transmitted. This may reflect the low concentrations of virus excreted, or attenuation may result in alteration of the biological properties of the virus to make it less transmissible.

Vaccine Reactions

Rubella vaccines are generally well tolerated. Lymphadenopathy, rash and joint symptoms may occur some 10–30 days after vaccination, although they are usually much less severe than following naturally acquired infection. Lymphadenopathy is often not noticed by vaccinees and, should rash be present, it is usually faint, macular and evanescent. Joint symptoms are rare in children of both sexes but up to 60% of postpubertal females may develop an arthralgia. The small joints of the hands are most commonly affected but other joints such as the wrists, knees and ankles may also be involved. Some vaccinees may experience a vaccine-induced arthritis, with swelling and limitation of joint movement. Symptoms rarely persist for longer than about a week and, although recurrences may occur, this is a rare event. Rubella vaccine strains have been isolated from the joint fluids of vaccinees with arthritis (Weibel *et al.*, 1969). A recent study showed that there was a significantly higher frequency of certain

class II (HLA DR) antigens among women with joint symptoms after receiving RA27/3 vaccine. Thus, there was a higher frequency of DR2 and DR5 and lower frequencies of DR4 and DR6 in vaccinees with arthropathy than in placebo recipients (Mitchell *et al.*, 1998). Hormonal changes may also affect the development of joint symptoms (p 396).

Vaccine Failures

Rubella is a labile virus and is therefore inactivated by exposure to heat and light. Manufacturers recommend that vaccine be stored at 2–8°C and that after reconstitution it should be kept at that temperature, protected from light and used within 1 hour. Failure to adhere to these instructions is the most frequent reason for vaccinees failing to seroconvert. Approximately 5% of vaccinees fail to respond for unexplained reasons, but usually respond satisfactorily if revaccinated. A few may fail to do so, or respond poorly, because they have a pre-existing low level of antibody which is undetectable by some techniques. Seroconversion after vaccination should be assessed normally at 8 weeks or so after vaccination, but occasional vaccinees may experience a delayed response, antibodies appearing even later. Passively acquired antibody, whether from blood transfusion, immunoglobulin or maternally acquired, may interfere with vaccine uptake. Vaccination should be delayed for 3 months following blood transfusion or administration of immunoglobulin (but see below).

Contraindications

As with other live vaccines, patients who are immunocompromised as a result of disease or its treatment (including cytotoxic drugs, corticosteroids or radiotherapy) should not be vaccinated. Contraindications should also be extended to those with thrombocytopenia.

Patients who are HIV positive, whether with or without symptoms, may be vaccinated, since they do not appear to suffer complications following the administration of attenuated vaccines for polio or measles and, if unprotected, may experience severe infections (particularly with measles). Since measles vaccine is usually administered as MMR, HIV

positive persons (particularly children) should benefit from being afforded protection (Department of Health *et al.*, 1996).

If another live vaccine is to be administered at the same time, both should be given simultaneously but at different sites (except in the case of MMR). Alternatively, the vaccinations should be separated by an interval of at least 3 weeks. A 3 week interval should also be allowed between the administration of rubella and of BCG. If the patient is suffering from a febrile illness, it is better to delay rubella vaccination. The manufacturer's leaflet should be studied carefully when patients with known hypersensitivity are to be vaccinated, since rubella vaccines contain traces of antibiotics (neomycin and/or kanamycin or polymyxin). There is increasing evidence that MMR vaccine can be given safely to children with an allergy to egg. Pregnancy should be avoided for 1 month after administration of rubella and MMR vaccines (Department of Health *et al.*, 1996). Although passively acquired antibodies may interfere with antibody responses following rubella vaccination, if anti-D is required, it may be given at the same time, but at different sites and from different syringes. Anti-D does not interfere with vaccine-induced antibody responses (Department of Health *et al.*, 1996).

Reinfection

Evidence of reinfection is usually obtained serologically by demonstrating a significant rise in antibody titre (p 407). Experimental studies suggest that reinfection is more likely to occur in those whose immunity is vaccine-induced rather than naturally acquired, and that the incidence of reinfection is higher among those vaccinated with Cendehill and HPV77-derived vaccines, than among those given RA27/3 (reviewed in Banatvala and Best, 1989). A transient rubella-specific IgM response may be detected, sometimes at only a low level, if serum is tested by a sensitive technique within 6 weeks of exposure. Viraemia has very occasionally been detected in vaccinees who have been reinfected naturally or experimentally. The risk of such reinfection resulting in fetal damage is small (p 397).

Table 12.5 Combined data for risk of CRS in infants born to susceptible women whose pregnancies were complicated by rubella vaccination

Country	Live births to women receiving rubella immunization			
	Within 3 months of conception or during pregnancy	Between 1 week before and 4 weeks after conception	Evidence of infection	Abnormalities compatible with CRS
USA	321	113/312	6/222 (2.7)	0/321
Germany (West—BRD)	260 ^a	NK	3/144 (2.1)	0/260
Sweden	5	NK	0/5	0/5
UK	71 ^b	25/71	4 ^c /52 (7.7)	0/71
Totals	657	138/383	13/423 (3.1)	0/657

Values in parentheses are percentages.

NK = not known.

^a Gisela Enders, 1998, personal communication.

^b Pat Tookey, 1998, personal communication. Includes one set of twins.

^c Three of the rubella IgM-positive infants were born to mothers who acquired rubella between 1 week before and 4 weeks after conception.

Vaccination during Pregnancy

Although RV has been recovered from the products of conception following vaccination of susceptible pregnant women, it is encouraging that evidence of fetal damage has not been reported. Examination of the products of conception of rubella-susceptible women inadvertently vaccinated during pregnancy has shown that RV may be recovered from the placenta, kidney and bone marrow for up to 94 days after vaccination, indicating that vaccine virus can cross the placenta and establish persistent fetal infection. Follow-up studies on women who elected to go to term following inadvertent vaccination during pregnancy, or within 3 months before conception, revealed no abnormalities compatible with congenital rubella among 657 babies delivered by these women. However, there was virological evidence of congenital infection in 13 of 423 (3.1%) babies tested (Table 12.5). In the US study, 212 of the 306 babies tested were born to women who had received the RA27/3 vaccine strain. It should be noted, however, that only 138 of 383 (36%) women in the combined series were vaccinated between 1 week before and 4 weeks after conception (Table 12.5). If rubella vaccines were to induce congenital defects, it may be necessary for infection to occur during a much shorter period than following naturally acquired infection. Many of the cases included in these follow-up studies were vaccinated within the 3 months before conception, which is probably of minimal risk. The theoretical maximum

risk of rubella-induced major malformations among infants delivered of susceptible mothers has been calculated (based on the 95% confidence limits of the binomial distribution) to be 1.2% (Bart *et al.*, 1985; Enders, 1985). This is less than the risk of major malformation occurring in 'normal' pregnancies (approximately 3%). Antibody screening prior to vaccination should considerably reduce the number of women who might be inadvertently vaccinated during pregnancy, for which an unacceptably high proportion of terminations are carried out. On the other hand, the two-stage procedure involving screening and vaccination may be counterproductive, deterring patients and their doctors from achieving higher immunization rates. This could be overcome by ensuring that a woman was using effective contraception; there would then be relatively little risk of vaccination during pregnancy. Even if the vaccinee was subsequently found to be pregnant, it would be possible to determine prior immune status retrospectively by testing serum samples obtained after vaccination for rubella-specific IgM.

Vaccination Policies

Vaccination programmes should be widely acceptable and readily implementable. The aim of rubella vaccination programmes is to prevent women acquiring rubella while they are pregnant. Two main policies were initially used:

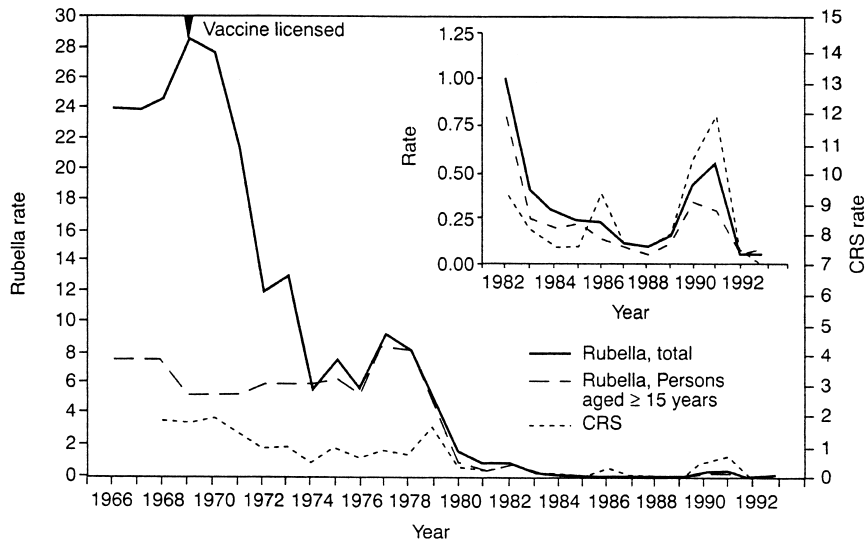

Figure 12.11 Incidence rates of rubella and congenital rubella syndrome (CRS) in the USA, 1966–1993. Cases of rubella reported to the National Notifiable Disease Surveillance System per 100 000 population; cases of CRS reported to the National CRS Registry per 100 000 live births. (From Centers for Disease Control, 1994)

- Universal childhood immunization, the aim of which is to interrupt transmission of the virus by vaccinating all preschool children, thus reducing the risk of women being exposed to rubella during pregnancy. This policy requires a high (at least 85%) uptake of vaccine among preschool children to be effective.
- Selective vaccination, the aim of which is to protect the population at risk. This can be achieved by vaccinating prepubertal schoolgirls in order to protect future pregnancies. Selective vaccination should also target women of child-bearing age who are shown to be susceptible. This will usually be achieved by vaccinating women *post partum*, when they have been shown to be rubella susceptible when tested antenatally.

Universal childhood immunization was adopted in the USA as early as 1969. This policy is incorporated in their existing programme of childhood immunizations and rubella vaccine is offered to all preschool children of both sexes. As rubella vaccine is given as MMR and proof of measles immunization is mandatory before school entry in all States, a very high proportion of children are immunized against rubella. This programme resulted in a more than 99% decrease in the number of cases of rubella reported between 1969 and 1988

(Figure 12.11). However, as a number of rubella outbreaks occurred among adolescents and young adults in the late 1970s, further emphasis was then placed on vaccinating susceptibles in these older age groups, which resulted in a further decline in rubella notifications.

Since 1978 there has been a decline in the incidence of CRS in the USA, which has paralleled the decline in postnatally acquired rubella (Figure 12.11). Although there is substantial unreporting of CRS, it was anticipated that CRS was on the verge of elimination in the USA in the 1980s. However, in 1989–1990 there was a resurgence of CAR in southern California and among the Amish population in Pennsylvania (Lindegren *et al.*, 1991). This was the result of missed opportunities for rubella screening or vaccination (Schluter *et al.*, 1998); many of the cases of maternal rubella could have been prevented if *post partum* immunisation had been carried out following previous pregnancies.

The USA policy results in a financial saving: cost–benefit analysis shows that the cost of rubella in an unvaccinated population is approximately 11 times more than the cost of the vaccination policy.

From 1970 until 1988, the UK followed a selective policy which was directed towards prepubertal schoolgirls and rubella-susceptible women of child-bearing age. The selective vaccination programme

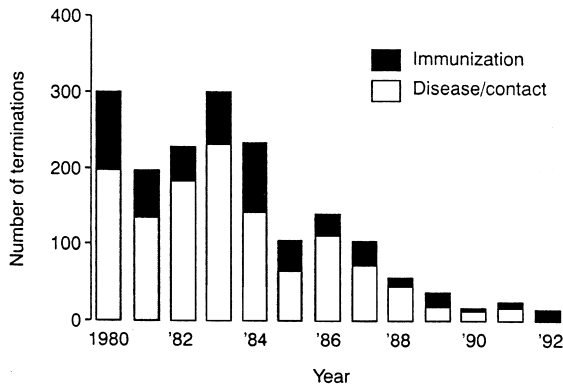

Figure 12.12 Terminations of pregnancy associated with rubella (England and Wales) 1980–1992. (reproduced with permission of the PHLS Communicable Disease Surveillance Centre © PHLS, and from Banatvala and Best, *Topley and Wilson*, 9th edition, Vol. 1)

was replaced with universal immunization of children in 1988, since some of the remaining susceptible pregnant women (2–3%) were infected during outbreaks.

The UK universal vaccination programme is, as in the USA, directed towards 1–2 year old children of both sexes, and the vaccine is administered as MMR. However, vaccination of susceptible women *post partum* continues and it has been agreed recently that children should be given a booster dose of MMR at 4–5 years of age in order to protect those who failed to be vaccinated in infancy or who were vaccine failures. Recently, USA authorities have also recommended the administration of a second dose of MMR for 4–6-year-old children (Centers for Disease Control, 1998).

In 1994–1995 only 2% of nulliparous and 1.2% of parous women were rubella susceptible, and this, together with the decline in circulation of rubella among young children, has resulted in termination of pregnancy because of maternal rubella and CAR now being very rare in Britain (Figure 12.12). Despite the extensive outbreak of rubella in 1996, which affected mostly adolescents and young males, there was little spread to the community and few pregnant women were affected, probably because of the high level of herd immunity in adult females. Most affected infants are now delivered of women coming to the UK as adults, who were not immunized as schoolgirls abroad (Miller *et al.*, 1997).

Sweden and Finland have introduced successfully similar two dose rubella vaccination programmes,

and virtually eliminated measles, mumps and rubella (Böttiger and Forsgren, 1997).

Rubella vaccination strategies are unsatisfactory in many developing countries, since only 28% are implementing national rubella vaccination programmes. Vaccination is directed towards children, sometimes selectively at schoolgirls, but not at women of childbearing age (particularly *post partum*). There is unlikely to be a reduction in CAR until susceptible women are vaccinated systematically (Robertson *et al.*, 1997). To reduce CAR rapidly, both children and susceptible women should be targeted. Consideration should be given to dispensing with antibody screening of adult women in developing countries, for, although some women may already be pregnant or become so within a month of vaccination, the accumulated data from a number of national programmes is sufficiently convincing to provide reassurance that rubella vaccine is most unlikely to induce fetal damage.

An ideal opportunity now exists to implement rubella vaccination programmes in developing countries, as measles vaccination uptake rates globally average about 80% or more. Many regions are adopting elimination goals for measles and, in those countries with a coverage of at least 80%, consideration should be given to vaccinating 1–2-year-old children with a combined measles and rubella vaccine. However, such selective programmes will not interrupt virus transmission to susceptible pregnant women (see above).

Caution must be expressed about the introduction of rubella vaccination in countries with relatively low measles uptake rates, e.g. parts of Africa with uptake rates of about 60%. Intermediate rubella vaccination rates will only increase the average age of infection and, consequently, the incidence of CAR.

PASSIVE IMMUNIZATION

Women who come into contact with rubella and for whom a termination would be unacceptable may be offered normal human immunoglobulin or high-titred rubella immunoglobulin. Although normal human immunoglobulin may reduce the incidence of clinically overt infection, subclinical infection may still occur. Since subclinical infection is accom-

panied by viraemia, there is still a risk of fetal infection. It has been shown that the infants of women who experienced subclinical rubella in early pregnancy following administration of normal immunoglobulin were less likely to be infected *in utero*, or, if infected, less severely affected, than infants of mothers not given this preparation (Peckham, 1972). It is proposed that the immunoglobulin decreased viraemia and there was consequently less damage (reviewed by Hanshaw *et al.*, 1985).

The administration of normal immunoglobulin to susceptible pregnant women who are determined to proceed to term after exposure to rubella has been advocated (Hanshaw *et al.*, 1985), giving a dose of 1500 mg of immunoglobulin intramuscularly as soon as possible after exposure. This should be followed by an additional dose of 1500 mg 3–4 days later (i.e. about 6 days after exposure and probably just prior to the onset of viraemia). Such patients, however, should be carefully followed up to see whether subclinical infection ensues. Normal human immunoglobulin will not interfere with the interpretation of serological tests, as it induces only a transient and low antibody response, but it may result in the incubation period being prolonged.

Encouraging results were obtained when high-titred rubella immunoglobulin, prepared by the Scottish Blood Transfusion Service, was used experimentally. When volunteers were given high-titre immunoglobulin and rubella vaccine simultaneously, eight of 20 (40%) failed to seroconvert and the remaining 12 exhibited delayed antibody responses compared with volunteers given vaccine alone; however, this preparation is in short supply and has not been properly evaluated in the field. Pepsin-treated normal human immunoglobulin given intravenously before exposure has been shown to be effective in preventing rubella. Preparations for intravenous use, however, may transmit hepatitis B, and care should also be taken to exclude donors who are in high-risk groups for HIV infection.

REFERENCES

- Arnold, J.J., McIntosh, E.D., Martin, F.J. *et al.* (1994) A fifty-year follow-up of ocular defects in congenital rubella: late ocular manifestations. *Australian and New Zealand Journal of Ophthalmology*, **22**, 1–6.
- Banatvala, J.E. (1977) Health of mother, fetus and neonate following maternal infections during pregnancy. In *Infections and Pregnancy* (ed. C.R. Coid), pp 437–488. Academic Press, London.
- Banatvala, J.E. (1987) Insulin-dependent (juvenile-onset, type 1) diabetes mellitus; coxsackie B viruses revisited. *Progress in Medical Virology*, **34**, 33–54.
- Banatvala, J.E. and Best, J.M. (1984) Rubella. In *Topley and Wilson's Principles of Bacteriology, Virology and Immunity*, 7th edn, vol. 4 (eds F. Brown and G. Wilson), pp 271–302. Edward Arnold, London.
- Banatvala, J.E. and Best J.M. (1989) Rubella vaccines. In *Recent Developments in Prophylactic Immunisation* (ed. A.J. Zuckerman), pp 155–180, Kluwer, Lancaster.
- Banatvala, J.E. and Best, J.M. (1990) Rubella. In *Topley and Wilson's Principles of Bacteriology, Virology and Immunity*, 8th edn, vol. 1 (eds L. Collier and M. Timbury), pp 501–531. Edward Arnold, London.
- Banatvala, J.E. and Best, J.M. (1998) Rubella. In *Topley and Wilson's Microbiology and Microbial Infections*, 9th edn, vol. 1 (eds B.J. Mahy and L. Collier), pp 551–577. Edward Arnold, London.
- Bart, S.W., Stetler, H.C., Preblud, S.R. *et al.* (1985) Fetal risk associated with rubella vaccine: an update. *Reviews of Infectious Diseases*, **7** (suppl. 1), S95–102.
- Best, J.M. (1991) Rubella vaccines—past, present and future. *Epidemiology and Infection*, **107**, 17–30.
- Best, J.M. and O'Shea, S. (1995) Rubella virus. In *Diagnostic Procedure for Viral, Rickettsial and Chlamydial Infections*, 7th edn (eds E.H. Lennette, D.A. Lennette and E.T. Lennette), pp 583–600. American Public Health Association, Washington DC.
- Best, J.M., Banatvala, J.E., Morgan-Capner, P. *et al.* (1989) Fetal infection after maternal reinfection with rubella: criteria for defining reinfection. *BMJ*, **299**, 773–775.
- Best, J.M., Thomson, A., Rey Nores, J. *et al.* (1993) Rubella virus strains show no major antigenic differences. *Intervirology*, **34**, 164–168.
- Bosma, T.J., Corbett, K.M., Eckstein, M.B. *et al.* (1995a) Use of PCR for prenatal and postnatal diagnosis of congenital rubella. *Journal of Clinical Microbiology*, **33**, 2881–2887.
- Bosma, T.J., Corbett, K.M., O'Shea, S. *et al.* (1995b) Use of the polymerase chain reaction for the detection of rubella virus RNA in clinical samples. *Journal of Clinical Microbiology*, **33**, 1075–1079.
- Bosma, T.J., Best, J.M., Corbett, K.M. *et al.* (1996) Nucleotide sequence analysis of a major antigenic domain of the E1 glycoprotein of 22 rubella virus isolates. *Journal of General Virology*, **77**, 2523–2530.
- Bosma, T.J., Etherington, J., O'Shea, S. *et al.* (1998) Rubella virus and chronic joint disease: is there an association? *Journal of Clinical Microbiology*, **36**, 3524–3526.
- Böttiger, M. and Forsgren, M. (1997) Twenty years' experience of rubella vaccination in Sweden: 10 years of selective vaccination (of 12-year-old girls and of women postpartum) and 13 years of a general two-dose vaccination. *Vaccine*, **15**, 1538–1544.
- Buimovici-Klein, E. and Cooper, L.Z. (1985) Cell-mediated immune response in rubella infections. *Reviews of Infectious Diseases*, **7** (suppl. 1), S123–128.
- Buimovici-Klein, E., Lang, P.B., Ziring, P.R. *et al.* (1979) Impaired cell mediated immune response in patients with congenital rubella: correlation with gestational age at time of infection. *Pediatrics*, **64**, 620–626.

- Burke, J.P., Hinman, A.R. and Krugman, S. (1985) International symposium on prevention of congenital rubella infection. *Reviews of Infectious Diseases*, **7** (suppl. 1).
- Centers for Disease Control (1994) Reported vaccine-preventable diseases—United States 1993. *Morbidity and Mortality Weekly Report*, **43**, 57–60.
- Centers for Disease Control (1998) Measles, mumps, and rubella—vaccine use and strategies for elimination of measles, rubella and congenital rubella syndrome and control of mumps: recommendations of the Advisory Committee on Immunisation Practices (ACIP). *Morbidity and Mortality Weekly Report*, **47** (RR-8), 1–58.
- Chantler, J.K. and Tingle, A.J. (1980) Replication and expression of rubella virus in human lymphocyte populations. *Journal of General Virology*, **50**, 317–328.
- Chantler, J.K., Smydis, L. and Tai, G. (1995) Selective infection of astrocytes in human glial cell cultures by rubella virus. *Journal of Laboratory Investigations*, **72**, 334–340.
- Chantler, S., Evans, C.J., Mortimer, P.P. *et al.* (1982) A comparison of antibody capture radio- and enzyme immunoassays with immunofluorescence for detecting IgM antibody in infants with congenital rubella. *Journal of Virological Methods*, **4**, 305–313.
- Chaye, H., Chong, P., Triplet, B. *et al.* (1992) Localization of the virus neutralising and hemagglutinin epitopes of E1 glycoprotein of rubella virus. *Virology*, **189**, 483–492.
- Cooper, L.Z. (1975) Congenital rubella in the United States. *Progress in Clinical and Biological Research*, **3**, 1–21.
- Cooper, L.Z. and Krugman, S. (1967) Clinical manifestations of postnatal and congenital rubella. *Archives of Ophthalmology*, **77**, 434–439.
- Cradock-Watson, J.E., Ridehalgh, M.K.S., Anderson, M.J. *et al.* (1980) Fetal infection resulting from maternal rubella after the first trimester of pregnancy. *Journal of Hygiene*, **85**, 381–391.
- Cremer, N.E., Oshiro, L.S., Weil, M.L. *et al.* (1975) Isolation of rubella virus from brain in chronic progressive panencephalitis. *Journal of General Virology*, **29**, 143–153.
- Cusi, M.G., Metelli, R., Valensin, P.E. *et al.* (1989) Immune responses to wild and vaccine rubella viruses after rubella vaccination. *Archives of Virology*, **106**, 63–72.
- Cutts, F.T., Robertson, S.E., Diaz-Ortega, J.-L. and Samuel, R. (1997) Control of rubella and congenital rubella syndrome (CRS) in developing countries, part 1: burden of disease from CRS. *Bulletin of the World Health Organization*, **75**, 55–68.
- Department of Health, Welsh Office, Scottish Office Department of Health, DHSS (Northern Ireland) (1996) *Immunisation Against Infectious Disease*. HMSO, London.
- Desmond, M.M., Wilson, G.S., Melnick, J.L. *et al.* (1967) Congenital rubella encephalitis. Course and early sequelae. *Journal of Pediatrics*, **71**, 311–331.
- Dorsett, P.H., Miller, D.C., Green, K.U. *et al.* (1985) Structure and function of the rubella virus proteins. *Reviews in Infectious Diseases*, **7**, S150–156.
- Dowdle, W.R., Ferreira, W., De Salles Gomes, L.F. *et al.* (1970) WHO collaborative study on the seroepidemiology of rubella in Caribbean and Middle and South American populations in 1968. *Bulletin of the World Health Organization*, **42**, 419–422.
- Eckstein, M.B., Brown, D.W.G., Foster, A. *et al.* (1996) Congenital rubella in south India: diagnosis using saliva from infants with cataract. *BMJ*, **312**, 161.
- Enders, G. (1985) Rubella antibody titres in vaccinated and non-vaccinated women and results of vaccination during pregnancy. *Reviews in Infectious Diseases*, **7** (suppl. 1), S103–112.
- Enders, G., Nickerl-Pacher, U., Miller, E. *et al.* (1988) Outcome of confirmed periconceptional maternal rubella. *Lancet*, **i**, 1445–1446.
- Frey, T.K. (1994) Molecular biology of rubella virus. *Advances in Virus Research*, **44**, 69–160.
- Frey, T.K., Abernathy, E.S., Bosma, T.J. *et al.* (1998) Molecular analysis of rubella virus epidemiology across three continents, North America, Europe and Asia, 1961–1997. *Journal of Infectious Diseases*, **178**, 642–650.
- Green, K.Y. and Dorsett, P.H. (1986) Rubella virus antigens: localization of epitopes involved in hemagglutination and neutralisation by using monoclonal antibodies. *Journal of Virology*, **57**, 893–898.
- Gregg, N.McA. (1941) Congenital cataract following German measles in mother. *Transactions of the Ophthalmological Society of Australia*, **3**, 35–46.
- Grillner, L., Forsgren, M., Barr, B. *et al.* (1983) Outcome of rubella during pregnancy with special reference to the 17th–24th weeks of gestation. *Scandinavian Journal of Infectious Diseases*, **15**, 321–325.
- Hanshaw, J.B., Dudgeon, J.A. and Marshall, W.C. (1985) *Viral Diseases of the Fetus and Newborn*, 2nd edn. W.B. Saunders, Philadelphia.
- Hemphill, M.L., Forng, R.-Y., Abernathy, E.S. *et al.* (1988) Time course of virus-specific macromolecular synthesis during rubella virus infection in Vero cells. *Virology*, **162**, 65–75.
- Herrmann, K.L. (1979) Rubella virus. In *Diagnostic Procedures for Viral, Rickettsial and Chlamydial Infections*, 5th edn (eds E.H. Lennette and N.J. Schmidt), pp 725–766. American Public Health Association, Washington DC.
- Horzinek, M.C. (1981) *Non-arthropod-borne Togaviruses*. Academic Press, London.
- Hosking, C.S., Pyman, C. and Wilkins, B. (1983) The nerve deaf child—intrauterine rubella or not? *Archives of Disease in Childhood*, **58**, 327–329.
- Karounos, D.G., Wolinsky, J.S. and Thomas, J.W. (1993) Monoclonal antibody to rubella virus capsid protein recognises a beta-cell antigen. *Journal of Immunology*, **150**, 3080–3085.
- Lindegren, M.L., Fehrs, L.J., Hadler, S.C. *et al.* (1991) Update: rubella and congenital rubella syndrome, 1980–1990. *Epidemiological Reviews*, **13**, 341–348.
- Magliano, D., Marshall, J.A., Bowden, D.S. *et al.* (1998) Rubella virus replication complexes are virus modified lysosomes. *Virology*, **240**, 57–63.
- Maller, R., Fryden, A. and Soren, L. (1978) Mitogen stimulation and distribution of T- and B-lymphocytes during natural rubella infection. *Acta Pathologica, Microbiologica et Immunologica Scandinavica. Section C, Immunology*, **86**, 93–98.
- Marttila, J., Ilonen, J., Lehtinen, M. *et al.* (1996) Definition of three minimal T helper cell epitopes of rubella virus E1 glycoprotein. *Clinical and Experimental Immunology*, **104**, 394–397.
- Mauracher, C.A., Mitchell, L.A. and Tingle, A.J. (1993) Selective tolerance to the E1 protein of rubella virus in congenital rubella syndrome. *Journal of Immunology*, **151**, 2041–2049.
- Menser, M.A., Dods, L. and Harley, J.D. (1967a) A twenty-five year follow-up of congenital rubella. *Lancet*, **ii**, 1347–1350.
- Menser, M.A., Harley, J.D., Hertzberg, R. *et al.* (1967b) Persist-

- ence of virus in lens for three years after prenatal rubella. *Lancet*, **ii**, 387–388.
- Miller, E., Cradock-Watson, J.E. and Pollock, T.M. (1982) Consequences of confirmed maternal rubella at successive stages of pregnancy. *Lancet*, **ii**, 781–784.
- Miller, E., Waight, P.A., Vurdien, J.E. *et al.* (1993) Rubella surveillance to December 1992: second joint report from the PHLS and the National Congenital Rubella Surveillance Programme. *Communicable Disease Report*, **3** (review 3), R35–40.
- Miller, E., Tookey, P., Morgan-Capner, P. *et al.* (1994) Rubella surveillance to June 1994: third joint report from the PHLS and the National Congenital Rubella Surveillance Programme. *Communicable Disease Report*, **4** (review 12), R146–152.
- Miller, E., Waight, P.A., Gay, N. *et al.* (1997) The epidemiology of rubella in England and Wales before and after the 1994 measles and rubella vaccination campaign: fourth joint report from the PHLS and the National Congenital Rubella Surveillance Programme. *Communicable Disease Report*, **7** (Review 2), R26–32.
- Mitchell, L.A., Zhang, T., Ho, M. *et al.* (1992) Characterisation of rubella virus-specific antibody responses by using a new synthetic peptide-based enzyme linked immunosorbent assay. *Journal of Clinical Microbiology*, **30**, 1841–1847.
- Mitchell, L.A., Decarie, D., Tingle, A.J. *et al.* (1993) Identification of immunoreactive regions of rubella virus E1 and E2 envelope proteins by using synthetic peptides. *Virus Research*, **29**, 33–57.
- Mitchell, L.A., Decarie, D., Tingle, A.J. *et al.* (1994) Use of synthetic peptides to map regions of rubella virus capsid protein recognised by human T lymphocytes. *Vaccine*, **12**, 639–645.
- Mitchell, L.A., Tingle, A.J., MacWilliam, L. *et al.* (1998) HLA-DR class II associations with rubella vaccine-induced joint manifestations. *Journal of Infectious Diseases*, **177**, 5–12.
- Morgan-Capner, P., Miller, E., Vurdien, J.E. *et al.* (1991) Outcome of pregnancy after maternal reinfection with rubella. *Communicable Disease Report*, **1** (review 1), R57–59.
- Niwa, Y and Kanoh, T. (1979) Immunological behaviour following rubella infection. *Clinical and Experimental Immunology*, **37**, 470–476.
- Norrby, E. (1969) Rubella Virus. *Virology Monographs*, vol. 7, pp 115–174. Springer-Verlag, Vienna.
- Numazaki, K., Goldman, H., Seemayer, T.A. *et al.* (1990) Infection by human cytomegalovirus and rubella of cultured human fetal islets of Langerhans. *In Vivo*, **4**, 49–54.
- O'Shea, S., Best, J.M. and Banatvala, J.E. (1983) Viremia, virus excretion, and antibody responses after challenge in volunteers with low levels of antibody to rubella virus. *Journal of Infectious Diseases*, **148**, 639–647.
- O'Shea, S., Best, J.M., Banatvala, J.E. *et al.* (1985) Development and persistence of class specific serum and nasopharyngeal antibodies in rubella vaccinees. *Journal of Infectious Diseases*, **151**, 89–98.
- O'Shea, S., Best, J.M. and Banatvala, J.E. (1992) A lymphocyte transformation assay for the diagnosis of congenital rubella. *Journal of Virological Methods*, **37**, 139–148.
- O'Shea, S., Corbett, K.M., Barrow, S.M. *et al.* (1994) Rubella reinfection; role of neutralising antibodies and cell-mediated immunity. *Clinical and Diagnostic Virology*, **2**, 349–358.
- Ou, D., Chong, P., Tripet, B. *et al.* (1992) Analysis of T- and B-cell epitopes of capsid protein of rubella virus by using synthetic peptides. *Journal of Virology*, **66**, 1674–1681.
- Parkman, P.D., Buescher, E.L. and Arstenstein, M.S. (1962) Recovery of rubella virus from army recruits. *Proceedings of the Society for Experimental Biology and Medicine*, **111**, 225–230.
- Peckham, C.S. (1972) Clinical and laboratory study of children exposed *in utero* to maternal rubella. *Archives of Disease in Childhood*, **47**, 571–577.
- Perry, K.R., Brown, W.G., Parry, J.V. *et al.* (1993) Detection of measles, mumps and rubella antibodies in saliva using antibody capture radioimmunoassay. *Journal of Medical Virology*, **40**, 235–240.
- PHLS Working Party on the Laboratory diagnosis of Rubella (1988) Summary of the recommendations. *Microbiology Digest*, **5**, 49–51.
- Pugachev, K.V., Abernathy, E.S. and Frey, T.K. (1997) Genomic sequence of the RA27/3 vaccine strain of rubella virus. *Archives of Virology*, **141**, 1165–1180.
- Revello, M.G., Baldanti, F.S., Sarasini, A. *et al.* (1997) Prenatal diagnosis of rubella virus infection by direct detection and semiquantitation of viral RNA in clinical samples by reverse transcription-PCR. *Journal of Clinical Microbiology*, **35**, 708–713.
- Robertson, S.E., Cutts, F.T., Samuel, R. *et al.* (1997) Control of rubella and congenital rubella syndrome (CRS) in developing countries, part 2: vaccination against rubella. *Bulletin of the World Health Organization*, **75**, 69–80.
- Salisbury, D.M. and Savinykh, A.I. (1991) Rubella and congenital rubella syndrome in developing countries. Document EPI/GAG/91/WP.15. Presented at the *EPI Global Advisory Group Meeting*, Antalya, Turkey, 14–18 October 1991.
- Schluter, W.W., Reef, S.E., Redd, S.C., *et al.* (1998) Changing epidemiology of congenital rubella syndrome in the United States. *Journal of Infectious Diseases*, **178**, 636–641.
- Skendzel, L.P. (1996) Rubella immunity—defining the level of protective antibody. *American Journal of Clinical Pathology*, **106**, 170–174.
- Starkey, W.G., Newcombe, J., Corbett, K.M. *et al.* (1995) Use of rubella E1 fusion proteins for the detection of rubella antibodies. *Journal of Clinical Microbiology*, **33**, 270–274.
- Stewart, G.L., Parkman, P.D., Hopps, H.E. (1967) Rubella virus hemagglutination-inhibition test. *New England Journal of Medicine*, **276**, 554–557.
- Terry, G.M., Ho-Terry, L.M., Londesborough, P. *et al.* (1988) Localization of the rubella E1 epitopes. *Archives of Virology*, **98**, 189–197.
- Thomas, H.I.J. and Morgan-Capner, P. (1988) Rubella-specific IgG subclass concentrations in sera using an enzyme-linked immunosorbent assay (ELISA): the effect of different sources of rubella antigen. *Epidemiology and Infection*, **101**, 599–604.
- Thomas, H.I.J. and Morgan-Capner, P. (1990) The avidity of specific IgM detected in primary rubella and reinfection. *Epidemiology and Infection*, **104**, 489–497.
- Thomas, H.I.J., Morgan-Capner, P., Cradock-Watson, J. *et al.* (1993) Slow maturation of IgG₁ avidity in congenital rubella: implications for diagnosis and immunopathology. *Journal of Medical Virology*, **41**, 196–200.
- Tøndury, G. and Smith, D.W. (1966) Fetal rubella pathology. *Journal of Pediatrics*, **68**, 867–879.
- Van der Logt, J.T.M., van Loon, A.M. and van der Veen, J. (1980)

- Replication of rubella virus in human mononuclear blood cells. *Infection and Immunity*, **27**, 309–314.
- Vejtorp, M. and Mansa, B. (1980) Rubella IgM antibodies in sera from infants born after maternal rubella later than the 12th week of pregnancy. *Scandinavian Journal of Infectious Diseases*, **12**, 1–5.
- Vesikari, T. (1980) Suppression of lymphocyte PHA—responsiveness after rubella vaccination with Cendehill and RA27/3 strains. *Scandinavian Journal of Infectious Diseases*, **12**, 7–11.
- Weibel, R.E., Stokes, J. Jr, *et al.* (1969) Rubella vaccination in adult females. *New England Journal of Medicine*, **280**, 682–685.
- Weil, M.J., Itabashi, H. and Creamer, N.E. (1975) Chronic progressive panencephalitis due to rubella virus simulating subacute sclerosing panencephalitis. *New England Journal of Medicine*, **292**, 994–998.
- Weller, T.H. and Neva, F.A. (1962) Propagation in tissue culture of cytopathic agents from patients with rubella-like illness. *Proceedings of the Society for Experimental Biology and Medicine*, **111**, 215–225.
- Wolinsky, J.S. (1996) Rubella. In *Fields Virology*, 3rd edn (eds B.N. Fields, D.M. Knipe, P.M. Howley *et al.*), pp 899–929, Lippincott-Raven, Philadelphia.
- Wolinsky, J.S., McCarthy, M., Allen-Cannady, O. *et al.* (1991) Monoclonal antibody-defined epitope map of expressed rubella virus protein domains. *Journal of Virology*, **65**, 3986–3994.
- Yoneda, T., Urade, M., Sakuda, M. *et al.* (1986) Altered growth, differentiation, and responsiveness of epidermal growth factor human embryonic mesenchymal cells of palate by persistent rubella virus infection. *Journal of Clinical Investigation*, **77**, 1613–1621.
- Yoon, J.-W., Choi, D.-S., Liang, H.-C. *et al.* (1992) Induction of an organ-specific autoimmune disease, lymphocytic hypophysitis, in hamsters by recombinant rubella virus glycoprotein and prevention of disease by neonatal thymectomy. *Journal of Virology*, **66**, 1210–1214.
- Ziring, P.R., Gallo, G., Finegold, M. *et al.* (1977) Chronic lymphocytic thyroiditis: identification of rubella virus antigen in the thyroid of a child with congenital rubella. *Journal of Pediatrics*, **90**, 419–420.

Mumps

Pauli Leinikki

National Public Health Institute, Helsinki, Finland

INTRODUCTION

Mumps is an acute infectious disease of children and young adults, caused by a paramyxovirus. The description by Hippocrates in the fifth century BC of an epidemic disease with swelling near the ear and painful enlargement of the testis is usually cited as the first description of mumps. Over the last two centuries the disease has been reported from most countries of the world. Outbreaks in military personnel have received special attention, and mumps has been a considerable health problem for the armed forces until recently. In 1918, during the First World War the mortality rate among the US and French armies was as high as 75 per 1000 men, causing as serious a problem as the opposing army.

Johnson and Goodpasture (1934) were able to show that the disease could be transmitted to rhesus monkeys by means of a filterable agent. Habel (1945) cultured the virus in chick embryo, and as early as in the mid-1940s both live attenuated and inactivated vaccines were tried in experimental animals and human volunteers (Enders *et al.*, 1946; Henle *et al.*, 1951).

THE VIRUS

Mumps virus taxonomically located in the family of paramyxoviruses where, along with *Newcastle disease virus* and *Simian virus 5* it forms a separate genus called *Rubulavirus*. (Bellini *et al.*, 1998).

Paramyxovirus virions are enveloped spherical particles with surface spikes projecting from the envelope (Figure 13.1). Inside, there is a large, helically arranged nucleocapsid. The virus is sensitive to lipid solvents and is labile, 90–99% of infectivity being lost in 2 hours at 4°C in protein-free medium.

Comprehensive details of the structure of *Mumps virus* have been given by Kelen and McLeod (1977) and Strauss and Strauss (1983). The size of the virion shows considerable variation. Usually the diameter is between 150 and 200 nm but bigger virions are occasionally seen (up to 340 nm). A 220 nm filter which is commonly used in virological laboratories to remove bacteria from biological fluids may, in certain conditions, retain a large proportion of viral activity. A few virions contain multiple copies of nucleocapsid. The biological function of these ‘supervirions’ is not known.

Chemical analysis of the virion reveals that less than 1% of the total weight of the virion is RNA, 73% protein, 20% lipids and 6% carbohydrate.

The RNA is a single molecule, located in a helical nucleocapsid composed of the RNA and predominantly one protein species, the nucleoprotein (NP). The RNA is not infectious if inserted into a cell in naked form—the virus is a negative-stranded RNA virus. If, however, a nucleocapsid is used instead of naked RNA, infection of the target cell follows, indicating that nucleocapsid proteins play an essential role in the replicative cycle of the virus.

The genome has about 16 000 nucleotides. The virion contains RNA polymerase, haemagglutinin and neuraminidase activities and the following

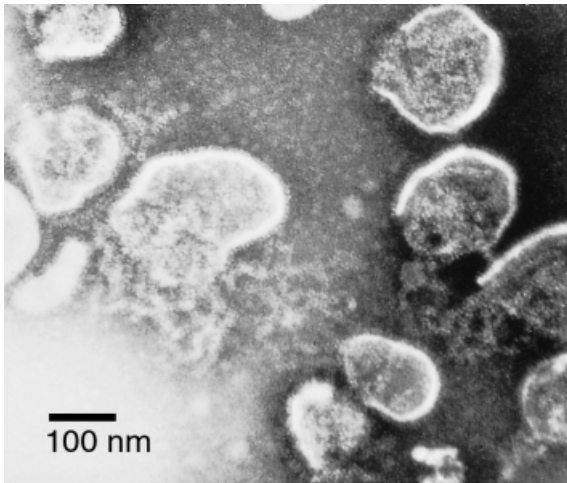

Figure 13.1 Electron micrograph of disrupting mumps virions, revealing the enveloped structure and unfolding nucleocapsid

peptides have been identified in it: L (large polymerase, molecular weight > 160 kDa), HN (haemagglutinin-neuraminidase, 65–74 kDa), three fusion proteins (F_0 , 60–68 kDa, F_1 , 48–59 kDa, F_2 , 10–15 kDa), NP (nucleocapsid protein, 56–61 kDa), M (matrix protein, 34–41 kDa), P (phosphoprotein, 44–84 kDa and SH (function unknown, 5 kDa) (Figure 13.2). In addition, at least four nonstructural proteins, designated C, V, W and I are coded by the viral genome (Bellini *et al.*, 1998). The gene order (from the 3' end) is NP-P/V-M-F-SH-HN-L (Elango *et al.*, 1998).

NP plays a central role in the encapsidation, transcription and replication of viral RNA. It is the most abundant protein of the virion and of the infected cells. P proteins serve an important role in RNA synthesis. They are components of viral polymerase complexes and probably bind both to NP and L proteins. The M protein forms the structure which underlies the viral envelope. It is important for the assembly of the virions during the replicative cycle. The HN glycoproteins agglutinate red cells of many species. Haemagglutination of avian cells is widely used in the diagnostic methods for mumps. A separate part of the molecule carries neuraminidase activity, which mediates the attachment of the virion to target cells via receptor molecules of the cell which contain sialic acid. The protein also plays a role in the fusion of plasma membranes and viral envelope working together with the F protein.

F protein is actually made of two subunits, F_1 and F_2 , which are formed as a result of proteolytic

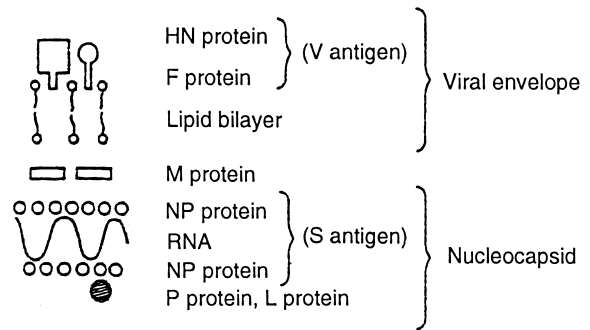

Figure 13.2 Structural components of the mumps virion

cleavage of a larger precursor molecule called F_0 . The F proteins play an essential role in the fusion of membranes. Antibodies reacting with F proteins inhibit haemolysis caused by *Mumps virus* and neutralize it. The F proteins are probably crucial in determining the spread of the virus in a cell population and also in the body. The proteolytic cleavage of F_0 to subunits is a host cell function. Failure of this cleavage due either to host cell malfunction or to change in the amino acid composition of F_0 results in the production of non-infectious viruses.

In purified virions actin is frequently found. M protein has a strong affinity for actin but the biological role of this virus-associated actin is unknown.

The function of SH protein is still unknown. The SH genome has been used for genetic distinction of mumps virus strains. Geographically restricted lineages have been identified which seem to be stable over time but which do not show similar progressive strain evolution as in influenza (Afzal *et al.*, 1997).

Antigenic Structure of the Virus

Only a single serotype of mumps virus is known (Hopps and Parkman, 1979). It cross-reacts considerably with other members of the genus *Paramyxovirus*. In serum samples derived from mumps patients, significant rises in antibody titres are often seen against heterologous viruses, most often against parainfluenza type 1. The viral glycoproteins HN and F are responsible for the cross-reactivity, while NP and M proteins elicit a more type-specific response. Two different antigenic preparations are used in the diagnostic laboratory.

Mumps V antigen consists predominantly of HN glycoprotein, while mumps S antigen is largely NP. In mumps infections antibodies develop first against S antigen and only later against V antigen. By measuring antibodies to the two antigens it is possible to make a specific laboratory diagnosis quite early in the course of infection (p 424).

Antibodies against HN and F proteins neutralize infectious virus but immunoblot analysis reveals that all components of the virion are immunogenic.

Replicative Cycle of Mumps

The virion attaches to its specific cellular receptor followed by a fusion of the viral envelope with the plasma membrane. Replication occurs exclusively in the cytoplasm. The genome is arranged in a single linear sequence from where the transcription proceeds, so that the polymerase stops and reinitiates mRNA synthesis at each gene junction. Accumulation of viral proteins leads to a switch from transcription to virion maturation. Regulation of the various steps of transcription is a complex process involving different viral proteins. For viral assembly complete nucleocapsids must be formed that are engulfed into the viral envelope by a budding process whose details are poorly understood (Bellini *et al.*, 1998).

Several details of the molecular biology of mumps still await experimental confirmation. Understanding the events in viral infections at a molecular level will help us to understand the mechanisms whereby *Mumps virus* can produce acute or chronic infection and which components are crucial for establishing protective immunity.

PATHOGENESIS

Mumps is transmitted by droplet spread or by direct contact, and the primary site of replication for the virus is the epithelium of the upper respiratory tract or eye (Feldman, 1982). The first infected cells form the primary focus, from which the virus spreads to local lymphoid tissues. Further multiplication within this restricted area results eventually in the primary viraemia, during which the virus is seeded to distant sites. The parotid gland is usually involved but so may be the central nervous system

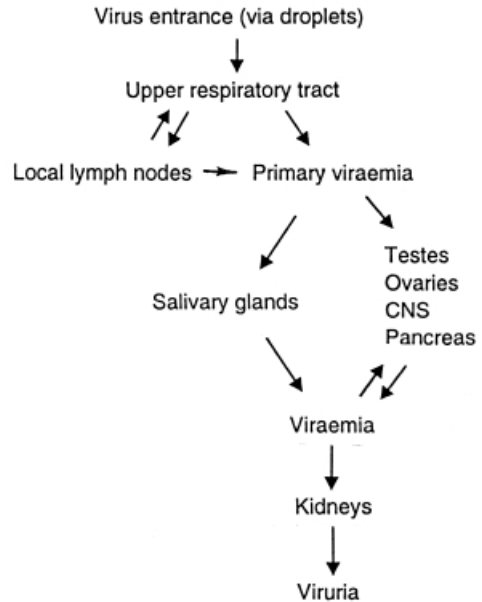

Figure 13.3 Pathogenesis of mumps infection. primary and secondary viraemia can both lead to infection of target organs other than salivary glands

(CNS), testis or epididymis, pancreas or ovary. A few days after the onset of clinical parotitis, virus can again be isolated from blood, indicating that virus multiplication in target organs leads to a secondary viraemia (Figure 13.3). As a result, virus may again spread to various target organs. The clinical course of mumps virus infection is quite variable: meningitis may precede parotitis by a week, the disease may manifest with orchitis only, with a combination of pancreatitis and orchitis, and so on. Nevertheless, parotitis is the most frequent presentation, occurring in 95% of those with clinical symptoms.

Virus is excreted in the urine in infectious form starting at any time during the 2 weeks following the onset of clinical disease. It is not known whether virus actually multiplies in renal tissues or whether the virus is of haematogenous origin, but in most cases slight abnormalities can be detected in renal function, such as microscopic haematuria and proteinuria. Virus is also excreted in breast milk, and it has been suggested that the virus multiplies in the lactating breast.

Interferon probably plays an important role in the pathogenesis. Highest concentrations can be detected within the first few days. Interferon can also be found in saliva and cerebrospinal fluid (CSF). Mumps infection results in a marked in-

crease of specific antibodies of IgG, IgM and IgA antibody classes. It also stimulates a cell-mediated immune reaction which can be demonstrated *in vitro* for a few months after the infection. Which of these responses is most important for protective immunity is not known. Mumps is not a clinical problem in immunocompromised children.

Pathological changes induced by the virus in various organs are non-specific. In the parotid glands they include serofibrinous exudate and polymorphonuclear cells in the connective tissue and within the ducts. The ductal cells show degeneration but inclusion bodies have not been described. In infected testes the changes may be more pronounced, with marked congestion and punctate haemorrhages. Similar changes have been described in the pancreatic tissue.

Within the CNS the lesions are not well known. In meningitis, electroencephalograms usually show little alteration, suggesting that the lesions are located predominantly in the meninges. In the rare cases where encephalitis occurs as a complication of mumps, lesions are found in the spinal cord and brain tissue. It seems evident that the lesions are produced from the combined effect of direct viral cytopathic effect and immunopathological destruction of CNS cells. Involvement of the CNS may be associated with symptoms compatible with paralytic disease and deafness. The exact pathogenesis is not known.

On several occasions prolonged involvement of the CNS after clinically manifested mumps meningoencephalitis has been described (Julkunen *et al.*, 1985). Whether this reflects a true replication of virus within the brain tissue over an unusually long period or whether the clinical condition is a result of prolonged immunological damage is not known.

Mumps virus can multiply *in vitro* in human pancreatic islet cells (Parkkonen *et al.*, 1992). The virus can also grow in cell cultures from human joint tissues, causing chronic infection associated with an incomplete replicative cycle (Huppertz and Chantler, 1991).

CLINICAL PICTURE

Classic Parotitis

The incubation period is 16–18 days but may vary



Figure 13.4 A patient with mumps parotitis

from 14 to 25 days. Parotid swelling appears in 95% of those who develop clinical disease (Figure 13.4). The rate of subclinical infections varies somewhat with age but is, on average, 30%. In a small proportion the symptoms may resemble only mild respiratory tract illness. Patients with classic mumps develop enlargement of one parotid gland which, in 75% of cases, is followed 1–5 days later by enlargement of the contralateral gland. For 1–2 days prodromal symptoms may dominate; these include malaise, myalgia, headache and low-grade fever.

Vaccination status of the affected population may influence the clinical presentation of the disease by shifting the prevalent age distribution or affecting the course of the disease by pre-existing immunity. In an outbreak affecting both vaccinated and unvaccinated individuals of all age groups, 57% of the clinically affected people were males, 58% had fever, 57% general malaise, 39% headache, and 1% had rash. Meningitis was seen in 1%, and orchitis in 7% of the male cases (Visser *et al.*, 1998).

The parotid involvement causes initially local tenderness and sometimes earache, and a few days later clinically apparent swelling. This involves the entire gland, including the area in front of the ear lobe. The orifice of the glandular duct becomes red and oedematous, and direct pressure on the glands yields only clear fluid, if anything. Submandibular and sublingual glands are occasionally also involved but practically never without parotid infection.

The parotid swelling starts to subside after 4–7 days. Virus shedding into saliva begins a couple of days before clinical parotitis and ends 7–8 days later. Glandular swelling is followed by constitutional symptoms such as fever, which seldom exceeds 40°C, and pain. These diminish when the swelling has reached its maximum and the general feeling of the patient starts improving. Recovery is rapid unless followed by a complication. Sometimes presternal oedema and sublingual and laryngeal swelling may alter the classic picture. This is thought to result from lymphatic obstruction in the cervical and mandibular areas. Severe anorexia and photophobia have been described.

Complications

The course of mumps infection may be extremely variable, as described in the section on pathogenesis. Diseases such as orchitis or pancreatitis could therefore be regarded as systemic manifestations of mumps rather than true complications. However, since classic parotitis is so characteristic and clinically dominating, all other clinical features are often regarded as complications. For a further description of the clinical aspects of mumps virus infection see Marcy and Kibrick (1983) and Christie (1974).

Meningitis

Aseptic meningitis is a common complication of mumps patients. As many as 50% may show pleocytosis of the CSF and clinical signs are seen in 1–10%. Mumps meningitis can be associated with parotid swelling but can also occur in its absence, thus causing problems in differential diagnosis. *Mumps virus* used to be the most common virologically confirmed causative agent of aseptic meningitis before general vaccinations were started. It is

two to three times more frequent in males than in females and the age distribution is the same as for mumps parotitis.

Symptoms are indistinguishable from other types of aseptic meningitis and they can start from 1 week before parotid swelling to 3 weeks after it. Sometimes the clinical picture is more severe, 6–18% of hospitalized patients having symptoms resembling encephalitis (see below).

Laboratory examination of CSF reveals pleocytosis (usually < 500 lymphocytes ml⁻¹, sometimes up to 1000), normal or slightly decreased sugar. Virus can be isolated from the CSF during the first 2–3 days after the onset. Later, intrathecal synthesis of mumps antibodies can be demonstrated. Symptoms of meningitis subside 3–10 days after onset, and recovery is complete.

Encephalitis

Clinical features suggesting encephalitis are convulsions, focal neurological signs, movement disorders and changes in the sensory perception. Sometimes polio-like paralysis ensues and even fatalities have been reported. Probably both direct viral invasion and allergic inflammatory reactions lie behind the nervous tissue damage. The incidence of encephalitis is about 1 in 6000 cases of mumps.

Other Neurological Manifestations

Before vaccinations, mumps used to be one of the leading causes of hearing loss in children and young adults. According to a study from military forces in Finland, 4% of mumps cases among military recruits were associated with deafness or significant hearing loss (Vuori *et al.*, 1962). In most cases the condition was transient but in a few permanent dysfunction ensued. Hearing problems did not correlate with meningitis. The incidence of permanent hearing loss has been estimated to be 1 per 15 000 cases of mumps. Sometimes Ménière's disease is a late complication.

Orchitis and Oophoritis

After puberty the incidence of orchitis is 20–30%, and in 20–40% of cases there is bilateral involvement. Symptoms are acute, with pain and tenderness accompanied by fever, nausea and vomiting. The testis may enlarge three- to fourfold within 4–5

days. There is associated epididymitis in 85% of cases. Late sequelae include atrophy of testicular tissue, which may lead, in cases with bilateral disease, to infertility. Late sequelae of prepubertal orchitis are not known.

In females oophoritis is evident in approximately 5% of postpubertal cases. No correlation with infertility has been recorded. The condition may present with pelvic tenderness and cause problems of different diagnosis from acute appendicitis.

Pancreatitis

The exact frequency of pancreatitis is difficult to determine but figures as high as 5% have been proposed. Clinical signs such as epigastric pain and tenderness accompanied by vomiting may lead to the diagnosis, which can be confirmed by serum amylase determination. Although the clinical picture may be quite dramatic, the outcome is almost invariably good.

Other Manifestations

Sometimes such glands as the lacrimal, thyroid or prostate become affected by *Mumps virus*, producing unusual clinical presentations.

Arthralgia or monoarthritis, involving a large joint, are complications of mumps which may develop about 2 weeks after parotitis. They are most frequent in young male adults.

Myocarditis can usually be found only upon electrocardiographic examination. In 10–15% of all mumps patients typical changes are seen. No late sequelae are known.

Transient renal dysfunction is a frequent feature of clinical mumps. In very rare instances severe nephritis and thrombocytopenia may ensue, with a fatal outcome on occasion.

If a pregnant woman contracts mumps she has an increased risk of abortion. This is thought to be due to hormonal imbalance caused by viral infection. No evidence of an increased risk of congenital malformations has been documented in humans, although paramyxoviruses cause CNS abnormalities of the developing fetus in monkeys and *Mumps virus* can cause abnormalities in the developing chick lens.

Endocardial fibroelastosis, a rare condition affecting the inner lining of the heart, is associated with a positive skin test with mumps antigen. How-

ever, a link between *Mumps virus* and the condition is doubtful.

LABORATORY DIAGNOSIS

Virus Antibody Assays

Different serological tests have been used to demonstrate a rise in the specific antibody titres or the presence of IgM class antibodies. Complement fixation test employing S and V antigens prepared from the virions was earlier frequently used as the most common test. However, due to problems in reagent stability this technique has been replaced in many laboratories by enzyme immunosorbent assay (EIA) tests. EIA antibody levels correlate with levels of neutralizing antibodies, suggesting that EIA could also reflect the immune status of the individual (Leinikki *et al.*, 1979). However, the extent of cross-reactivity from exposure to closely related paramyxoviruses may cause problems in interpretation of the results in individual cases. The specificity of IgM antibody assays is greatly enhanced by using IgM capture techniques, where IgM class antibodies are separated in an additional incubation step from other serum constituents (Morgan-Capner, 1983).

Haemagglutination inhibition and neutralization antibody assays can be used as supplemental tests for both diagnostic cases and in immunity studies. Other tests, such as haemolysis in gel, can also be applied in virological laboratories.

Virus Detection

Mumps virus can be isolated from clinical samples using cell cultures or embryonated eggs. Both saliva and urine can be used as samples for diagnostic or epidemiological investigations. Mumps antigen has also been demonstrated from saliva samples by immunofluorescence or EIA techniques, allowing easy processing of large numbers of samples (reference). Polymerase chain reaction (PCR) applications may provide even more rapid and accurate diagnostic tools in the near future.

EPIDEMIOLOGY AND CONTROL

Mumps is a disease of childhood. In unvaccinated populations the highest incidence is in children between 5 and 9 years of age. The disease is somewhat less contagious than other childhood diseases, such as measles and varicella, and quite a number of children seem to escape the infection before puberty and even beyond. The proportion of seronegatives among medical students was less than 10% in a study of an unvaccinated population. According to a survey in the USA, a tenth of the population had mumps during each of the first five years of life, 74% had had it by the age of 10 and 95% by 20 years of age (Feldman, 1982).

General vaccinations have changed the epidemiological pattern profoundly. Prior to vaccination mumps used to be common in most urban areas, while in some less densely populated areas it caused widespread epidemics at 2–4 years intervals. A few descriptions of outbreaks in isolated areas have been published where the affected population had no pre-existing immunity. As can be expected, age as such did not protect; however, the proportion of subclinical infections increased with age, with the exception of the youngest children (2–3 years of age), in whom subclinical infections were also very frequent. Up to 90% of infections at the age of 10–14 years were associated with clinical symptoms, while practically all infections were subclinical beyond 60 years of age. Although the clinical symptoms are usually more severe in adolescents and young adults than in children, the frequency of complications follows closely the frequency of mumps in general. Two well-known exceptions are orchitis and oophoritis, which have a much higher frequency after puberty than before, and meningoencephalitis, which is two to three times more common in males than in females.

In temperate zones of the northern hemisphere a clear-cut seasonal variation is evident. From June to September the number of reported cases is on the average less than a third of the figures from January to May, according to a survey of 12 years and more than 150 000 cases. The peak months were February and March. No such seasonal variation is reported from tropical countries.

Only one serotype of *Mumps virus* exists and one would expect a lifelong immunity after natural infection. This is almost always the case but reinfec-

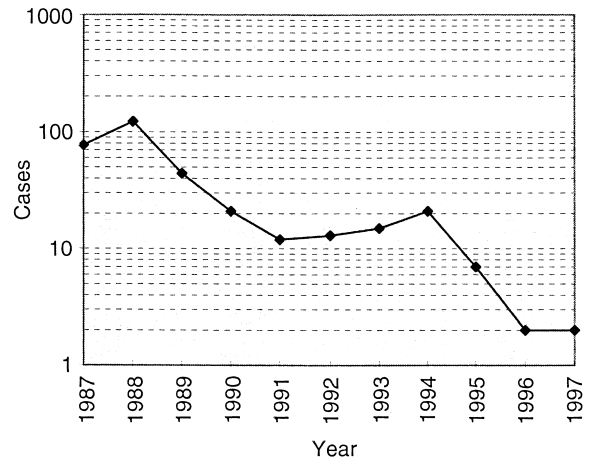

Figure 13.5 Decrease of incidence in mumps in Finland during the period 1987–1997, with universal MMR vaccination started in 1982 and good coverage (> 95 per cent)

tions have been reported in up to 1–2% of cases.

The role of divergent genomic lineages of *Mumps virus* in reinfections and vaccine failures is not known. In some epidemics the prevailing strain has shown differences compared to earlier strains (Stöhle *et al.*, 1996), but comparison of strains collected at different times in the past suggests that the established lineages show little molecular evolution. Even cocirculation of different lineages of *Mumps virus* in a single epidemic has been reported, suggesting that immunological selection of virus variants is not driving the evolution of mumps strains.

Control of mumps by immunization has been very successful. In the USA, the number of cases notified to the Centers of Disease Control and Prevention has dropped from over 150 000 annually to around 1500 cases (Centers for Disease Control and Prevention, 1995). In Finland, with a very high childhood vaccination coverage, the disease has been almost eradicated (National Public Health Institute, 1997) (Figure 13.5). With a population of about 5 million people, only a few cases occur annually and most of these have their origins outside the country. Large outbreaks of mumps in unvaccinated population in the neighbouring Russian territories have not led to local outbreaks in Finland in spite of frequent cross-border travel.

However, vaccinated populations have also encountered outbreaks of mumps in recent years (Briss *et al.*, 1994, Dias *et al.*, 1996, Visser *et al.*, 1998). Molecular characterization has not sugges-

ted that the causative strain in these instances is different from the common strains. Rather, multiple lineages have cocirculated, suggesting waning immunity. A possible explanation for the recent outbreaks is that immunity induced by live attenuated *Mumps virus* starts to wane in the absence of natural boosters that may occur as long as the virus is circulating in the population.

Even if the vaccine has not been able to prevent the disease, complications seem to be less common in vaccinated children (6% versus 1%, Visser *et al.*, 1998).

A strain called Jeryl Lynn has been used in most vaccinations worldwide. In order to improve the vaccine efficacy a new strain called Urabe was introduced in the 1980s. Unfortunately, it proved to be associated with increased frequency of CNS complications and has been withdrawn in most countries. Several other strains have been isolated and used as candidate vaccines. These include strains called Rubini, SBL 1, Leningrad and some others. No significant differences between the vaccine strains have, however, been detected.

REFERENCES

- Afzal, M.A., Buchanan, J., Heath, A.B. *et al.* (1997) Clustering of mumps virus isolates by SH gene sequence only partially reflects geographical origin. *Archives of Virology*, **142**, 227–238.
- Bellini, W.J., Rota, P.A. and Anderson, L.J. (1998) Paramyxoviruses. In *Topley and Wilson's Microbiology and Microbial Infections*. (eds L. Collier, A. Balows and M. Sussman), pp 435–461. Edward Arnold, London.
- Briss, P.A., Fehrs, L.J., Parker, R.A. *et al.* (1994) Sustained transmission of mumps in a highly vaccinated population: assessment of primary vaccine failure and waning vaccine-induced immunity. *Journal of Infectious Diseases*, **169**, 77–82.
- Centers for Disease Control and Prevention. (1995) Mumps surveillance—United States, 1988–1993. *Morbidity and Mortality Weekly Report*, **44** (SS-3), 1–14.
- Christie, A.B. (1974) Mumps. In *Infectious Diseases: Epidemiology and Clinical Practice*, pp 454–483.
- Dias, J.A., Cordeiro, M., Afzal, M.A. *et al.* (1996) Mumps epidemic in Portugal despite high vaccine coverage—preliminary report. *Eurosurveillance*, **1**(4), 25–28.
- Elango, N., Varsanyi, T.M., Kövamees, J. *et al.* (1988) Molecular cloning and characterization of six genes, determination of gene order and intergenic sequences and leader sequence of mumps virus. *Journal of General Virology*, **69**, 2893–2900.
- Enders, J.F., Levens, J.H., Stokes, J. Jr, *et al.* (1946) Attenuation of virulence with retention of antigenicity of mumps virus after passage in the embryonated egg. *Journal of Immunology*, **54**, 283–291.
- Feldman, H.A. (1982) Mumps. In *Viral Infections of Humans: Epidemiology and Control* (ed. A.S. Evans), pp 419–435. Plenum Medical, New York.
- Habel, K. (1945) Cultivation of mumps virus in the developing chick embryo and its application to studies of immunity to mumps in man. *Public Health Reports*, **60**, 201–212.
- Henle, G., Henle, W., Burgoon, J.S. *et al.* (1951) Studies on the prevention of mumps. I. The determination of susceptibility. *Journal of Immunology*, **66**, 535–549.
- Hopps, H.E. and Parkman, P.D. (1979) Mumps. In *Diagnostic Procedures for Viral, Rickettsial and Chlamydial Infections* (eds E.H. Lennette and N.J. Schmidt), pp 633–663. American Public Health Association, Washington DC.
- Huppertz, H.I. and Chantler, J.K. (1991) Restricted mumps virus infections of cells derived from normal human joint tissue. *Journal of General Virology*, **72**, 339–347.
- Johnson, C.D. and Goodpasture, E.W. (1934) An investigation of the aetiology of mumps. *Journal of Experimental Medicine*, **59**, 1–19.
- Julkunen, I., Koskiniemi, M.-L., Lehtokoski-Lehtiniemi, E. *et al.* (1985) Chronic mumps virus encephalitis. *Journal of Neuroimmunology*, **8**, 167–175.
- Kelen, E.E. and McLeod, D.A. (1977) Paramyxoviruses: comparative diagnosis of parainfluenza mumps, measles and respiratory syncytial virus infections. In *Comparative Diagnosis of Viral Diseases* (eds E. Kurstak and C. Kurstak), pp 503–607. Academic Press, New York.
- Leinikki, P., Shekarchi, I., Tzan, N. *et al.* (1979) Evaluation of enzyme linked immunosorbent assay (ELISA) for mumps virus antibodies. *Proceedings of the Society for Experimental Biology and Medicine*, **160**, 363–367.
- Marcy, S.M. and Kibrick, S. (1983) Mumps. In *Infectious Diseases* (ed. P. Hoepflich), pp 737–744. Harper & Row, New York.
- Morgan-Capner, P. (1983) The detection of rubella-specific antibody. *Public Health Laboratory Service Microbiology Digest*, **1**, 6–11.
- National Public Health Institute (1997) *Infectious Diseases (1996)*, pp 1–32. NPHI, Helsinki.
- Parkkonen, P., Hyöty, H., Koskinen, L. *et al.* (1992) Mumps virus infects beta cells in human fetal islet cell cultures up-regulating the expression of HLA class I molecules. *Dia-betologia*, **35**, 63–69.
- Stöhle, A., Bernasconi, C. and Germann, D. (1996) A new mumps virus lineage found in the 1995 mumps outbreak in Western Switzerland by nucleotide sequence analysis of the SH gene. *Archives of Virology*, **141**, 733–741.
- Strauss, E.G. and Strauss, J.H. (1983) Replication strategies of the single stranded RNA viruses of eukaryotes. *Current Topics in Microbiology and Immunology*, **105**, 45–79.
- Visser, L.E., Gonzales Peres, L.C., Tejera, R. *et al.* (1998) An outbreak of mumps in the province of León, Spain, 1995–1996. *Eurosurveillance*, **3**, 14–18.
- Vuori, M., Lahikainen, E.A. and Peltonen, T. (1962) Perceptive deafness in connection with mumps. *Acta Oto-Laryngologica*, **55**, 231–236.

Enteroviruses

Philip D. Minor¹, Peter Morgan-Capner² and Peter Muir³

¹*NIBSC, Potters Bar, Hertfordshire, UK*

²*Public Health Laboratory, Preston, UK*

³*Guy's, King's and St Thomas' School of Medicine, London, UK*

INTRODUCTION

The enteroviruses are a genus of the family *Picornaviridae*. Sixty-six serotypes of *Enterovirus* have been isolated from humans. Their normal site of replication is the intestinal tract, where infection may often be clinically inapparent, or result in a mild gastrointestinal disorder. However, in a proportion of cases the virus spreads to other organs, causing severe illnesses the characteristics of which are often typical of individual enterovirus types. Poliomyelitis is one of the most severe diseases caused by an enterovirus but members of the genus are also implicated in febrile illnesses, aseptic meningitis, myopericarditis, rashes and conjunctivitis. They may cause particularly severe disease in neonates.

This chapter describes the virological properties of enteroviruses, and the pathogenesis and clinical aspects of the diseases which they cause. Prevention is, so far, limited to poliomyelitis.

THE VIRUSES

Viruses of the *Picornaviridae* show similar morphological, structural and molecular properties and replication strategies. They are divided into five genera: the rhinoviruses, which are one of the causative agents of the common cold; the enteroviruses, which are surprisingly closely related to the

rhinoviruses; the cardioviruses, which cause diseases of mice; the aphthoviruses, which are causative agents of foot-and-mouth disease of cattle; and the hepatoviruses, a new genus encompassing hepatitis A viruses. The human enteroviruses include the polio, Coxsackie, enterocytopathic human orphan (echo) viruses and the more recently isolated enteroviruses designated enteroviruses 68–71. The various members of the group differ in their cultural characteristics, antigenic properties and certain features of their replication cycle, such as the receptor sites by which they gain access to the host cell. In all cases the normal habitat and primary site of replication of the virus are thought to be the intestinal tract.

Hepatitis A virus (HAV) was designated previously enterovirus 72. However, it is an atypical enterovirus by a number of criteria, including its nucleic acid sequence, extreme stability and its site of replication, which is currently thought to be the liver. Although it is a picornavirus transmitted by the faecal–oral route, HAV has now been reclassified into its own genus (Minor *et al.*, 1991, 1995). It is discussed in detail in Chapter 3. Similarly, echoviruses 22 and 23 are very different from other enteroviruses with respect to sequence, although not, so far as is known, clinical effects. They have now been classified into a separate genus, the genus *Parechovirus*.

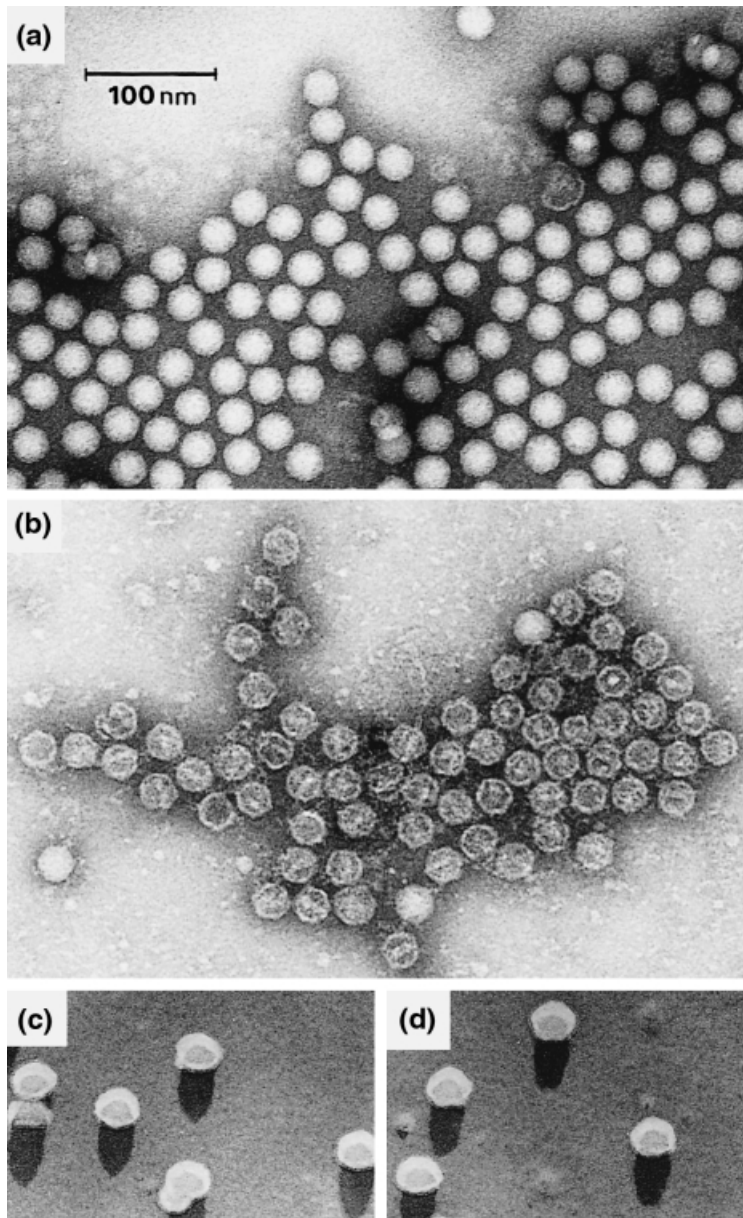

Figure 14.1 Electron micrograph of poliovirus, negatively stained with 4% sodium silicotungstate: (a) whole virus particles (D antigen) approximately 30 nm in diameter; (b) empty capsids, showing penetration of stain; (c) shadowed virus (print reversed to give black shadows) producing pointed shadows; (d) shadowed virus (print reversed to give black shadows) producing blunt-ended shadows.

Physical Characteristics of the Virus Particle

The virion is a largely featureless, symmetrical particle, approximately 27 nm in diameter when exam-

ined electron microscopically (Figure 14.1a). Non-infectious empty capsids, unlike virions, are penetrated by stain, revealing that the virion shell is approximately 2.5 nm thickness (Figure 14.1b). The essentially spherical appearance of the particle is consistent with a virus with icosahedral symmetry,

and this has been broadly confirmed by particle shadowing which produces pointed and blunt shadows (Figure 14.1c,d). The sedimentation coefficient of the intact virus on centrifugation is 155–160S, while that of the empty capsid is 70–80S. The buoyant density of the virion in caesium chloride gradients is 1.34 g ml^{-1} . A particle with the chemical composition of an enterovirus virion would be expected to have a density of 1.47 g ml^{-1} if freely permeable to caesium ions; the low density of the enteroviruses implies that the virion is essentially impermeable consistent with the failure of electron microscopic stains to penetrate infectious particles (Figure 14.1a). In the past, the behaviour of the viruses on isopycnic centrifugation has been used as a criterion for differentiating enteroviruses from rhinoviruses and aphthoviruses, both of which have a higher buoyant density in caesium chloride. The enteroviruses are stable to acid pH, also unlike the rhinovirus and aphthoviruses, which are inactivated by brief exposure to pH 2. This has also been used as a criterion for the identification of a picornavirus as an enterovirus.

Biochemical Structure of the Virus Particle

The infectious particle consists of a shell of 60 copies, each of four proteins, VP1, VP2, VP3 and VP4, arranged with icosahedral symmetry about a genome composed of a single strand of RNA of messenger sense. Like many eukaryotic messenger RNA molecules, the genomic RNA terminates in a sequence of 40–100 adenylic acid residues at the 3' end (the poly(A) tract.) At the 5' end, however, it bears a small protein (VPg) approximately 22 amino acids long, covalently linked to the RNA by the hydroxyl group of a tyrosine residue. The complete genomic sequences of several enteroviruses are now known. The virion is believed to be entirely devoid of carbohydrate, and lacks a lipid membrane, although as described below lipid molecules form an entegral part of the structure. The particle has a relative molecular weight (M_r) of 8×10^6 , of which the RNA provides 32% and the protein 68% by weight. The four principal structural proteins of the virion have molecular weights of approximately 30 000 (VP1), 27 000 (VP2), 24 000 (VP3) and 7000 (VP4). VP2 and VP4 are formed by the cleavage of a

precursor protein, VP0, as the last stage in the maturation of a virus particle, probably in an autocatalytic process resulting from the encapsidation of the nucleic acid genome.

The defined structure of the virus particle resulting from the absence of a lipid layer has made it possible to obtain crystals suitable for X-ray diffraction studies, and the molecular structures of poliovirus (Hogle *et al.*, 1985), rhinovirus type 14 (Rossman *et al.*, 1985), and CVB3 (Muckelbauer *et al.*, 1995) have been resolved such that the interactions involved in maintaining the structural features of the infectious virion are now clear. The three largest virion proteins VP1, VP2 and VP3 have a very similar core structure, in which the peptide backbone of the protein loops back on itself to form a barrel of eight strands held together by hydrogen bonds (the β barrel). This core forms a wedge shape, and the amino acid sequences between the sequences forming the β barrel, and the sequences at the N- and C-terminal portions of the protein contain elaborations which include the main antigenic sites involved in the neutralization of viral infection.

The proteins are arranged with icosahedral symmetry, with VP1 molecules at the pentameric apices of the icosahedron oriented such that the pointed end of the wedge-shaped protein points towards the apex. The other two proteins, VP2 and VP3, alternate about the centre of the triangular face of the icosahedron (the threefold axis of symmetry). There are extensive interactions between the three large proteins, and also with the fourth protein, VP4, which is internal. In particular, the N terminus of VP1 lies under VP3, and the N terminus of VP3 under VP1. The apical structure formed by VP1 is separated from the plateau formed by VP2 and VP3 by a cleft or canyon; the peak of the VP1 structure is 16.5 nm from the virion centre whilst the plateau made up of VP2 and VP3 is approximately 15 nm from the centre. The base of the cleft is of the order of 11 nm from the centre, and it has been postulated that this cleft may contain the regions of the virus to which the cellular receptor attaches. The interactions between the component proteins are such as to suggest that the most stable unit of the structure is a pentamer made up of five copies each of VP1, VP2, VP3 and VP4; it seems likely that this is the basic unit from which the virus is assembled. A diagrammatic representation of the three-dimensional structure of the capsid proteins of poliovirus type 1 is shown in Figure 14.2.

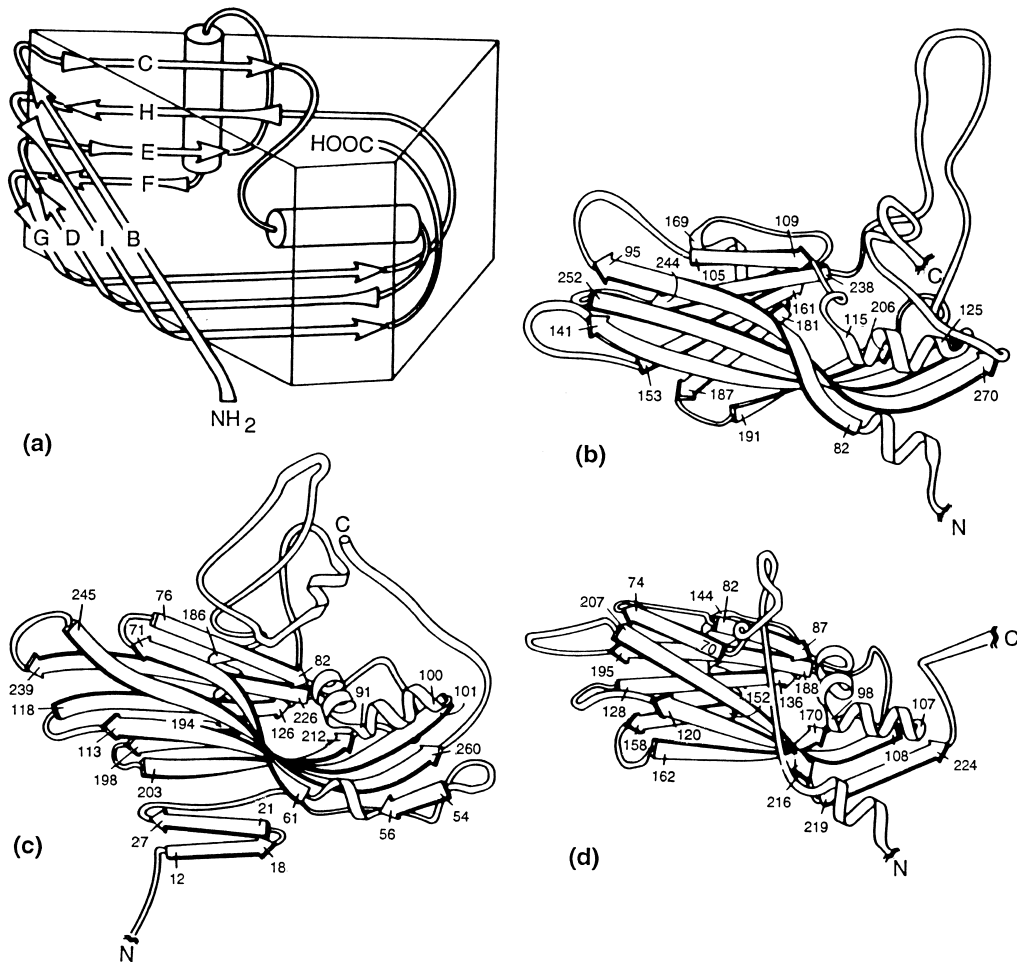

Figure 14.2 Three-dimensional structure of the capsid proteins of poliovirus (Hogle *et al.*, 1985). The numbers indicate positions of amino acid residues: (a) core structure common to capsid proteins; (b) VP1; (c) VP2; (d) VP3

In addition to the protein components of the virus, lipid molecules are also found in the structure. Myristic acid is found covalently attached to the N terminus of the smallest capsid protein VP4 (Chow *et al.*, 1987). The aliphatic chain penetrates the apex of the icosahedron, and it is possible that this forms a structural support for the virion. Myristic acid has been found to be attached to virion proteins in other viruses including retroviruses and rotaviruses. The other lipid moiety has not yet been identified, but has been shown to be present in the structures of poliovirus type 1 and type 3. It has a 16-carbon aliphatic chain which lies in the pocket formed by the beta barrel of VP1. The other end of the molecule has not been observed. Rhinovirus 14 has no such insert, and it is not yet clear how general a

feature of enteroviruses this lipid molecule is. However, certain antiviral compounds insert into the corresponding region of rhinovirus 14, and in so doing prevent uncoating. It is therefore possible that the lipid plays a part in uncoating or assembly of enteroviruses.

Antigenic Structure of the Virus

The antigenic properties of the enteroviruses provide one of the main methods of differentiating them. In most cases specific antiviral antisera neutralize only homologous virus, but this is not always so. For every picornavirus studied in detail, it has

been shown that empty capsids prepared under appropriate conditions present major antigenic determinants different from those of the infectious virus. Moreover, the infectious virus can be readily denatured by relatively mild conditions, such as treatment with ultraviolet light, heating to 56°C for 10 minutes or attachment to a plastic surface in enzyme-linked immunosorbent assay (ELISA) tests. The infectious particle is said to express D or N antigenic character, and the empty capsid or denatured virus C or H antigenic character. C antigen is less specific to a particular virus than is D antigen. Thus there is evidence for cross-reaction of C antigen-specific monoclonal antibodies with poliovirus of type 1, type 2 and type 3, whereas cross-reaction by neutralizing monoclonal antibodies or those reacting with D antigen is rare. However, monoclonal antibodies able to neutralize both type 1 and type 2 poliovirus have been reported (Uhlig *et al.*, 1990) and priming for a secondary response to type 1 or type 3 by previous injection with type 2 is documented (Katrak *et al.*, 1991). Similarly there is evidence for cross-reaction of echoviruses 11, 16 and 22 with poliovirus with appropriate C-specific antibodies. The difference between particles expressing D and C antigen is due to the conformation of the proteins, rather than to the loss of a protein. These antigenic characteristics suggest that methods based on virus neutralization by antibody may give different results concerning the identity of enterovirus strains to methods based on immunochemical techniques such as ELISA or immunoblot methods.

The antigenic structures involved in the neutralization of picornavirus infectivity have been the subject of much study and have been clarified by the resolution of the molecular structures of poliovirus and rhinovirus outlined above. The similarities in the structures which have been found to be important in neutralization of these two types of virus suggest that homologous features may be involved in all picornaviruses. Sites have been identified by the isolation of antigenic variants which are resistant to monoclonal antibodies able to neutralize a parental strain, and then characterized by sequencing the genomic RNA. This has revealed four major sites to which neutralizing antibodies bind. For type 3 poliovirus they include: (a) a sequence of VP1 about one-third of the way in from the N terminus involving residues 89–100, together with sequences from three other loops from VP1, includ-

ing amino acids 142, 166 and 253; (2) a complex site involving residues 220–222 of VP1 and 160–170 of VP2 and the C terminus of VP2; (3) a complex site involving residues 286–290 of VP1 and 58–60 of VP3 (Minor, 1990). The fourth site involves residues in different pentamers and is therefore only found in the intact virion, while the other sites are also found in some viral subunits. For poliovirus type 1, the site located at residues 89–100 of VP1 has been implicated in virus neutralization, although to a far lesser extent than for type 3 where the homologous region is the principal target for neutralizing antibodies in sera from immunized animals. The site involving VP3 is the next most common target of antibodies, including most of the antibodies showing extreme strain specificity for poliovirus, whilst the site involving VP2 is the least common.

The antigenic structure of type 2 virus has been less well characterized. The site to which cross-reactive antibodies bind appears to involve sequences around 200–210 of VP3 and 239–245 of VP2, and may be linked to the strain-specific site involving VP1 and VP3 (Uhlig *et al.*, 1990).

Cellular Receptor Sites

Enteroviruses attach to and enter cells by specific receptor sites. This was first shown for poliovirus by the observation that purified genomic RNA was infectious for rabbit cells whereas the virus itself was not. Competition experiments between different viruses have shown that, for example, all three poliovirus serotypes utilize the same cellular receptor, which is distinct from that for the Coxsackie B viruses. This phenomenon has been confirmed in a number of cases by the isolation of monoclonal antibodies, which will block specifically the attachment of certain types of virus by reacting with the host cell rather than with the virus (Minor *et al.*, 1984).

The enteroviruses and the picornaviruses in general are responsible for a range of diseases with different target organs. These include the heart (Coxsackie viruses), nerve tissue (polioviruses), liver (HAV) and others, as well as the intestinal tract. It is possible that the expression of the receptor sites in specific tissues plays a part in the tropism of the virus, although it is unlikely to be the only factor. This in turn may lead to a novel chemotherapeutic

approach to viral diseases; for example, by the use of chemically synthesized receptor analogues.

The gene encoding the cellular receptor for poliovirus has been identified (Mendelsohn *et al.*, 1989) and is a previously unknown three-domain protein of the immunoglobulin superfamily. The terminal domain is required for activity. Transgenic mice carrying the gene for the human receptor for poliovirus have been prepared by two groups (Ren *et al.*, 1990; Koike *et al.*, 1991) and are susceptible to poliovirus infection with a pathology similar to that shown by primates. Mouse cells are not normally susceptible to infection with poliovirus or most other human enteric viruses. When stably transfected with the human gene for the poliovirus receptor, however, they are rendered sensitive, and can thus be used to identify polioviruses in the presence of other viruses. This is of value in clinical studies related to the programme to eradicate poliomyelitis, as described later.

The receptor for *Echovirus 1* has been isolated and identified as the integrin VLA-2, a known surface molecule (Bergelson *et al.*, 1992). DAF (decay accelerating factor) a cell surface protein involved in the complement pathway has been shown to be a receptor site for many echoviruses (Bergelson *et al.*, 1994; Ward *et al.*, 1994) some coxsackie B viruses (Shafren *et al.*, 1995), and enterovirus 70 (Karnauchow *et al.*, 1996). *Coxsackie virus B1–6* serotypes also use a common receptor, also used by some adenoviruses, identified as a probable transmembrane protein of unknown function which contains two immunoglobulin-like domains, and is expressed preferentially in brain, heart and pancreas (Bergelson *et al.*, 1997). *Coxsackie virus A10, 15, 18* and *21* employ ICAM-1, as does the major rhinovirus group. *Coxsackie virus B3* also uses nucleolin, and *Coxsackie virus A9* $\alpha v\beta 3$ integrin.

Strategy of Replication

The genome of the virus is a single positive-strand RNA molecule, and thus acts as a messenger RNA for the synthesis of the proteins found in infected cells. The genome can be divided into four regions, comprising a sequence of about 750 bases with no known coding function, followed by a large open reading frame of which the first half codes for the structural protein found in the virus particle, while

the second half encodes proteins necessary for virus replication, such as the RNA polymerase. The fourth portion of the genome is a second short sequence with no known coding function. This arrangement is summarized in Figure 14.3. The non-coding regions are well conserved between related viruses, and there is thus reason to believe that they are of importance in virus replication.

The 5' non-coding region of eukaryotic messenger RNA usually terminates in a methylated guanosine cap, which is important in binding ribosomes and thus translation of the RNA into protein. Thus most eukaryotic messenger RNA molecules require a free 5' terminus, and initiation of translation internally is not possible. However, it has been shown that the 5' non-coding regions of poliovirus and other picornaviruses act as internal initiation sites so that ribosomes may bind in the absence of a free 5' capped terminal structure (Pelletier and Sonnenberg, 1988). In fact, infection with poliovirus results in the cessation of cap-dependent translation. The mechanism of internal initiation is believed to involve binding of as yet ill-defined factors to complex secondary and tertiary structures formed by the 5' non-coding region. Both the 5' and 3' non-coding regions must also be involved in the attachment of the RNA polymerase during RNA replication.

The viral proteins are synthesized as one large protein from a single open reading frame. The precursor protein includes two known sequences which act as proteolytic enzymes and digest the protein at specific positions as it, and they, are in the process of being synthesized. The first (P2A) acts to cleave the structural from the non-structural proteins, whilst the second completes all the other processing of the protein, except the final maturational cleavage of VP0 to VP2 and VP4. Apart from these two functions the non-structural proteins include a polymerase and the small genome-linked protein VPg, and a number of proteins of unknown but important function. Protein P2C is known to be virtually identical in all the polioviruses, for example, implying that it cannot be altered readily without affecting virus viability.

The synthesis of RNA is less well understood than that of protein. The positive-sense genomic RNA acts as a template for the synthesis of a negative-sense copy, which in turn acts as a template for more positive-sense strands. The positive-sense RNA is used both for translation and for packaging

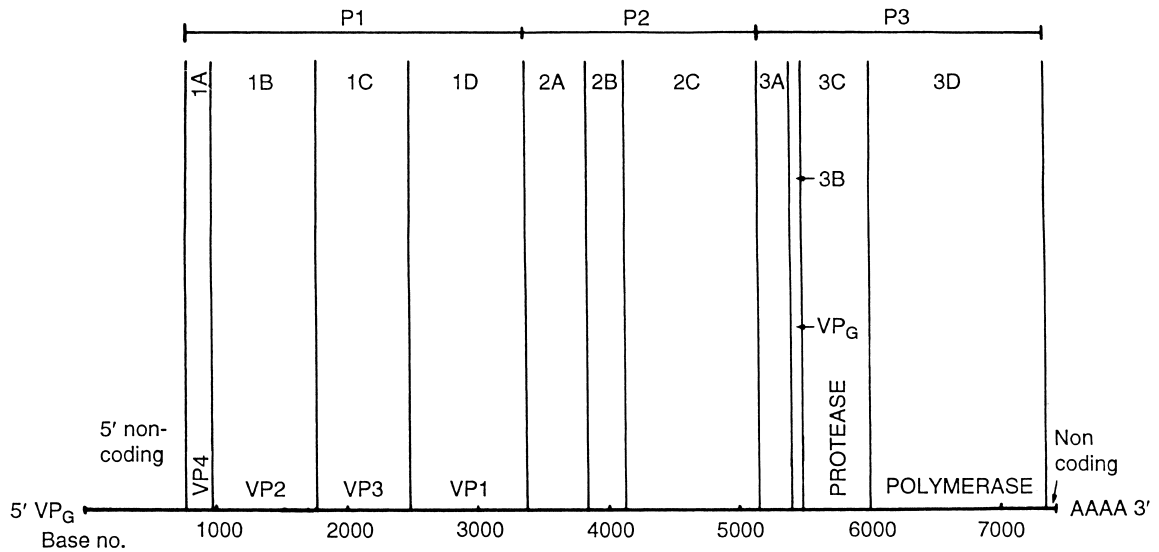

Figure 14.3 Organization of the genome of poliovirus, a typical enterovirus showing the two non-coding regions and the location of the regions coding for the various virus proteins. In the formal nomenclature (Rueckert and Wimmer, 1984), the P1 region encodes the structural capsid proteins, and the P2 and P3 regions encode non-structural proteins found only in infected cells

into virus and is the major species made after the early stages of infection. All nascent strands carry a 5' terminal molecule of VP_G. The polymerase activity indicated in Figure 14.3 is able to elongate nascent RNA *in vitro* but is unable to initiate RNA synthesis on its own. The mechanism of initiation is not yet fully known.

The assembly of the virus particle involves the synthesis of VP₀, VP₁ and VP₃ as a single unit, which is then assembled into pentamers, followed by the association of 12 pentamers into the virion, a process which involves host factors. The X-ray crystallographic structure of the virus implies that the final maturation cleavage of VP₀ to VP₂ and VP₄ is autocatalytic. Thus a serine residue is found close to the N-terminus of VP₂. A number of serine proteases are known, and it may be concluded that as soon as the proton donor, such as the genomic RNA, is brought into the vicinity of the serine residue the final cleavage will take place. The virus is in general released from the cell by lysis.

Sequence Comparisons of Enteroviruses

Sequences of the genomes of a number of enteroviruses and other picornaviruses have been determined (Stanway, 1990). Comparison of such sequences indicates the evolutionary relationship of

the different viruses, and reveals a surprisingly close relationship between the enteroviruses and rhinoviruses where the genomes show a high degree of homology. In contrast hepatitis A has no significant homology with the archetypal enteroviruses *Poliovirus type 1* at the nucleic acid level. *Echovirus 22* is also unique in sequence, showing no homology with other enteroviruses.

The human enteroviruses can be further divided into two groups on the basis of sequence comparisons of the 5' non-coding region (Pöyry *et al.*, 1996; Hyypiä *et al.*, 1997). One includes polioviruses, *Coxsackie virus A21* and *A24*, and *enterovirus 70*, while *Coxsackie B*, *Coxsackie virus A9*, *A16*, *enterovirus 71*, *Echovirus 11*, *Echovirus 12* and all partially sequenced enteroviruses form the second. Similar sequence comparisons of the coding region and 3' non-coding region result in four subdivisions of the human enteroviruses. the first group comprises the polioviruses and *Coxsackie virus A1*, *A11*, *A13*, *A17*, *A18*, *A21* and *A24*; the second group includes only *enterovirus types 68* and *70* so far; the third includes *Coxsackie virus B1-6*, *A9*, all enteroviruses except types 22 and 23, and *enterovirus 69*. *Coxsackie virus A2*, *A3*, *A5*, *A7*, *A8*, *A14*, *A16* and *enteroviruses 71* form the final group.

Sequenced animal enteroviruses, such as bovine enteroviruses, form a group distinct from the hu-

man enteroviruses when either the 5' non-coding region or the remainder of the genome is considered. Different regions of the genome vary in their homology between enteroviruses and other picornaviruses. Certain sections in the 5' non-coding region of the genome are identical in all enteroviruses examined, except for *Echovirus 22*, implying some definite functional constraint; this identity may carry over into the rhinoviruses, but it is possible to identify sequences which are apparently enterovirus specific. It is further possible to identify regions such as the 3' non-coding region which are strongly conserved for a particular species, such as a poliovirus. Finally, certain regions including areas coding for the coat protein VP1, but also some sequences in the 5' non-coding region, are extremely strain specific. In principle, as described later, it is possible to exploit these various types of region to devise genomic probes or polymerase chain reaction (PCR) primers which are specific for enteroviruses in general, for a particular species of enterovirus, or for a particular strain of a particular species. Such probes are valuable in clinical and epidemiological studies. They also imply a major function for regions of the genome such as the 5' and 3' non-coding regions where they are strongly conserved, although such functions have not yet been fully resolved.

PATHOBIOLOGICAL AND CLINICAL ASPECTS OF HUMAN ENTEROVIRUSES

The enterovirus serotypes of humans are distinguished on the basis of their homotypic seroneutralization, and exhibit a wide range of biological and pathogenic properties which are often characteristic of individual enterovirus groups. An extensive literature of up-to-date and authoritative reviews on the clinical, pathological and epidemiological properties of individual groups of human enteroviruses is available (Christie, 1987; Bendinelli and Friedman, 1988; Tracy *et al.*, 1991; Muir, 1992; Rotbart, 1995a; Melnick, 1996; Muir and van Loon, 1997), to which the reader is referred for further detailed information.

The viruses are divided into five groups: polioviruses, Cocksackie virus group A, Cocksackie virus group B, echo (enteric human cytopathogenic

orphan) viruses and recently characterized human enteroviruses. The virus types comprising each group are summarized in Table 14.1, together with the major diseases with which they are associated and their cultural characteristics.

The classification of the enteroviruses has followed closely the history of the development of knowledge on the aetiology of the diseases they cause. Poliovirus was first identified in 1909 by inoculation of monkeys with specimens from cases of paralytic poliomyelitis. Following the discovery by Enders *et al.* (1949) that poliovirus could be grown in cell cultures, the importance of the enteroviruses as a cause of human disease came to be appreciated. In 1948 Dalldorf and Sickles (1948) recovered a new group of agents by inoculation into newborn mice of faecal extracts from two children with paralytic disease. These agents were named Cocksackie viruses after the town in New York State where the isolations were made. Cocksackie virus types A and B were identified on the basis of the histopathological changes they produced in newborn mice and their capacity to grow in cell cultures. Later a third group, the echoviruses, was identified, which was also associated from time to time with human diseases. Echoviruses were found to be non-pathogenic for subhuman primates and newborn mice, but produced cytopathic changes in cell cultures. Within a few years it was found that all three groups of virus were antigenically distinct and consisted of several and, in some cases, numerous serological subtypes.

Since 1970, new enterovirus types have been allocated sequential numbers (68–71) following those allocated previously to enteroviruses. The enteroviruses have a worldwide distribution and collectively cause a considerable impact in morbidity and mortality. The extraordinarily wide range of diseases included in their clinical 'repertoire' contributes to their attraction as subjects for study by the molecular virologist, pathologist, clinician and epidemiologist alike. The diverse clinical properties of the viruses may be a reflection of the specificity of different viruses for different cell receptor sites, which in turn may determine the tissue tropism of the virus.

Enteroviruses are also found in lower mammals and simians, and in some cases serological relationships between human and animal viruses occur. For example, swine vesicular disease virus is closely related serologically to *Cocksackie virus B5*.

Table 14.1 Types and characters of human enteroviruses

Group	Virus types	Cytopathic effects in cell cultures		Pathology in newborn mice	Major disease associations
		Monkey kidney	Human cell culture		
Poliovirus	3 types (poliovirus 1–3)	+	+	–	Paralytic poliomyelitis; aseptic meningitis; febrile illness
Coxsackie virus group A	23 types (A1–A22, A24)	– or ±	– or ±	+	Aseptic meningitis; herpangina; febrile illness; conjunctivitis (A24); hand, foot and mouth disease
Coxsackie virus group B	6 types (B1–B6)	+	+	+	Aseptic meningitis; severe generalized neonatal disease; myopericarditis; encephalitis; pleurodynia (Bornholm disease); febrile illness
Echovirus	31 types (types 1–9, 11–27, 29–33)	+	±	–	Aseptic meningitis; rash; febrile illness; conjunctivitis; severe generalized neonatal disease
Enteroviruses	4 types (types 68–71)	+	+	–	Polio-like illness (E71); aseptic meningitis (E71); hand, foot and mouth disease (E71); epidemic conjunctivitis (E70)

Among the human enteroviruses it is the polioviruses for which details of antigenic and molecular structure are best understood, as described above. For most of the other viruses information is sparse. However, it is becoming clear that, despite their generally unique patterns of neutralization by antibody (on which virus typing is based), there are frequent and major antigenic cross-reactions between types which can be identified by other serological methods. For the human enteroviruses in general there is little documented evidence of progressive antigenic variation. Antigenically unusual strains can be isolated, however (Magrath *et al.*, 1986). For example, type 3 polioviruses isolated from patients with paralytic poliomyelitis in Finland in 1984 were antigenically clearly distinguishable from classic poliovirus type 3 strains isolated in the 1950s. It may be significant that the cases of poliomyelitis from which the viruses were isolated occurred in persons who were 'immunized' with inactivated vaccine. Other evidence of antigenic heterogeneity among viruses of a single serotype is the finding the *Coxsackie virus B5* strains isolated in 1973 in the USA are clearly distinguishable from the prototype 1952 strains (Melnick, 1990).

The host range of the enteroviruses varies between groups and types. Table 14.1 summarizes the ability of the viruses to replicate and produce cytopathogenic effects in cell cultures of monkey

kidney and human origin and their pathogenesis for suckling mice. A feature of Coxsackie viruses not shared by other enteroviruses is their pathogenesis in suckling mice. Coxsackie viruses A unlike Coxsackie B strains, replicate poorly if at all in monkey kidney cell cultures. Poliovirus, unlike other enteroviruses, causes flaccid paralysis in monkeys and chimpanzees when administered into the brain or spinal cord. Group A Coxsackie viruses produce widespread myositis in the skeletal muscles of newborn mice, resulting in flaccid paralysis without other obvious lesions. Group B viruses also produce myositis but it is generally of more focal distribution than that caused by group A viruses. In addition they cause necrotizing lesions of the brown fat pads (intrascapular cervical and cephalic pads) and, in the case of certain strains, encephalitis with spastic paralysis, pancreatitis, myocarditis, endocarditis and hepatitis in both infant and adult mice.

The common portal of entry for enteroviruses is generally thought to be the alimentary tract via the mouth. Replication of virus in the cells lining the alimentary tract may be preceded by, or accompany, oropharyngeal replication.

For several enterovirus types (e.g. poliovirus) a viraemic phase is followed by involvement of the target organs (e.g. spinal cord and brain, meninges, myocardium or skin). Incubation periods before

onset of disease vary widely from 2 to 30–40 days for different enteroviruses. The pathogenesis of poliovirus has been more fully studied (Minor, 1996) than that of any other enterovirus, but even in this case it is not fully understood. According to Bodian the virus, having entered via the alimentary tract, multiplies locally at the initial sites of virus colonization (tonsils, Peyer's patches) and associated lymph nodes. At this stage virus may be isolated from both throat and faeces. Secondary spread of virus apparently occurs via the blood to other susceptible tissues (e.g. other lymph nodes, brown fat pads and nervous tissue). On the other hand Sabin held the view that the virus replicates chiefly in the mucosal layers of the intestine or oropharynx, seeding the associated lymphoid tissues where it does not necessarily replicate. After a low-level, possibly undetectable viraemia, replication at distant unidentified sites leads to a secondary viraemia which may result in infection of either the peripheral or central nervous system. For further details see Minor (1996).

Within the central nervous system the virus appears to spread along nerve fibres. If local multiplication is extensive, motor neurons are destroyed and paralysis results. The anterior horn cells of the spinal cord are most prominently involved but in severe poliomyelitis the posterior horn and dorsal root ganglia are affected. Shedding of virus occurs from the throat and in faeces and thus transmission of infection occurs independently of invasion of the nervous system.

The major clinical aspects of enterovirus infection are summarized below.

Poliomyelitis

The clinical features and epidemiology of this disease have been reviewed in detail by Christie (1987) and Minor (1996). Progress towards its eradication is described later.

Although infection with poliovirus of type 1, 2 or 3 is inapparent commonly, or results in a mild febrile illness, aseptic meningitis or paralytic poliomyelitis may occur. However, only about 1% of infections result in illness with neurological involvement. Cases of abortive poliomyelitis, often accompanied by fever, malaise, headache, nausea or vomiting, are followed by uneventful recovery. However, a few patients develop aseptic meningitis

with stiffness and pain in the back and neck. The disease may last for up to 10 days and recovery is complete. Poliovirus is only one of several viruses which may cause such meningeal symptoms. In a small number of cases, this picture progresses to paralytic poliomyelitis.

Most cases of paralytic poliomyelitis occur without evidence of an earlier phase of illness. The most predominant sign is flaccid paralysis resulting from lower motor neuron damage. Painful spasms and incoordination of non-paralysed muscles may also occur. Death may be due to respiratory paralysis. In those who survive, some recovery of muscular function is common but may take 6 months or longer. In epidemics in developed countries in the early 1950s, typically 5% of cases were fatal, 10% showed full recovery with no sequelae, while the remainder showed permanent paralysis to some degree.

Many years after maximal recovery from the original attack of poliomyelitis, some patients develop further muscle weakness, the postpolio syndrome. There have been suggestions based on the detection of intrathecal poliovirus antibody, and the presence of poliovirus RNA in cerebrospinal fluid (Leparc-Goffart *et al.*, 1996), that in some cases this may be due to persistent polio-virus infection of neural cells, although there are alternative hypotheses such as ageing (Munsat, 1991). Persistence of poliovirus or other enterovirus infection of the central nervous system has also been implicated in the aetiology of motor neuron disease, and the presence of enterovirus RNA in cerebrospinal fluid or neural tissue has been reported in small numbers of patients (Woodall *et al.*, 1994; Leparc-Goffart *et al.*, 1996). However, one other study found that, while enterovirus RNA can be detected in postmortem brain and spinal cord tissue of patients with postpolio syndrome and motor neuron disease, viral RNA was also detectable in patients with other neurological or non-neurological diseases (Muir *et al.*, 1996), and was therefore unlikely to be related to chronic neurological disease.

Poliomyelitis, when epidemic, occurs primarily in the summer months in temperate zones. Non-polio enteroviruses, particularly *Coxsackie virus A7* and enterovirus 71, occasionally cause polio-like illness, and in some regions where wild polioviruses have been eradicated, enterovirus 71 is emerging as an important cause of acute flaccid paralysis (da Silva *et al.*, 1996).

Neonatal Infection

Coxsackie viruses B and echoviruses, particularly types 6, 7 and 11, may cause severe and often fatal infection in newborn infants (Modlin, 1988; Absug *et al.*, 1995). Although there have been occasional reports of intrauterine death resulting from maternal enterovirus infection, there is no confirmed association with congenital abnormalities. Infection may be transmitted transplacentally in late pregnancy, the infant developing heart failure soon after delivery from a severe myocarditis or a meningoencephalitis. More frequently, infection is transmitted during birth or postnatally via the mother or other virus-infected infants in nurseries for the newborn or special care baby units (reviewed by Gear and Measroch, 1973). Some infected neonates may be asymptomatic, but others will develop manifestations at three to seven days of age from a mild febrile illness to fulminating multisystem involvement and death. Myocarditis, pneumonia and meningoencephalitis may be present. A severe hepatitis with jaundice, which results in an increased prothrombin time, and profuse haemorrhage may also occur. These features, together with the recovery of Coxsackie virus B or echovirus from faeces, brain, spinal cord and myocardium, are indicative of a generalized infection. It is essential to establish a diagnosis as rapidly as possible in order to institute measures to prevent infection spreading to other infants. In outbreaks of neonatal infection with *Echovirus 11* there is evidence to suggest that administration of human convalescent serum containing a high neutralizing antibody titre to the virus may be of value in preventing or attenuating infection in susceptible neonates (Modlin, 1988).

CNS Infections

Aseptic Meningitis

Aseptic meningitis occurs most frequently in young children. A febrile illness may be followed by meningeal signs with stiffness of the neck or back, and muscle weakness may occur which is clinically reminiscent of mild poliomyelitis (Rotbart, 1995b). However, in infections caused by enteroviruses other than poliovirus there is almost always complete recovery from paresis. Coxsackie viruses of both group A and group B (especially types B1–B6,

A7 and A9) and many echoviruses (notably types 4, 6, 11, 14, 16, 25, 30, 31) have been associated with aseptic meningitis. Enterovirus 71 has been associated with meningitis and severe disease of the CNS as well as with a variety of other syndromes, including hand, foot and mouth disease (see below) and polio-like paralysis (Alexander *et al.*, 1994).

Patients with aseptic meningitis have a clear CSF which is usually under normal, or slightly increased, pressure. There is a pleocytosis, usually of the order of 10–500 per mm³, mainly of lymphocytes. However, during the first day or so after the onset of symptoms, polymorphonuclear leucocytes may predominate. The protein concentration is normal or slightly increased and the CSF glucose concentration is generally within normal limits.

Encephalitis

A generalized or focal encephalitis is an uncommon complication, but may be associated with aseptic meningitis, or be present with absent or minimal meningeal involvement. Children and young adults are most frequently affected. Although most patients recover uneventfully, a few have neurological sequelae or damage to the hypothalamic-pituitary axis which causes endocrine disturbance. CSF findings are similar to those occurring in aseptic meningitis.

Patients with hypogammaglobulinaemia may, if infected with enteroviruses, develop persistent infections in which chronic meningeal irritation or encephalitis, or sometimes a dermatomyositis-like syndrome, are prominent features (Wilfert *et al.*, 1977). Although some patients recover, there is a high mortality rate. Many echoviruses and Coxsackie viruses B have been shown to cause such persistent infections; occasionally, multiple serotypes may be involved. Patients with hypogammaglobulinaemia may develop paralytic disease following the administration of attenuated polio vaccine. Virus may be recovered from the CSF, sometimes intermittently, although high concentrations are usually present. Treatment with high-titre specific immunoglobulin has not been shown to be particularly effective in eradicating virus from the CNS.

Bornholm Disease (Epidemic Pleurodynia)

Coxsackie viruses B are the commonest cause of this syndrome, but echovirus serotypes including 1, 6, 9, 16 and 19, and such Coxsackie A viruses as A4, 6, 9 and 10, have also been implicated. Outbreaks involving families are common; more extensive community-wide epidemics have also been reported. The disease usually presents abruptly with fever and chest pain due to involvement of the intercostal muscles, or abdominal pain which results from involvement of the muscles of the upper part of the abdomen. This may be sufficiently severe to mimic an acute surgical condition requiring laparotomy, or myocardial infarction. Some patients have pain localized to the limbs. There is usually muscle tenderness and in some patients swelling may be seen or palpated in affected muscles. Most patients recover within a week, although about 25% of patients may experience relapses, usually within a few days of being symptom free.

Enteroviruses have also been implicated in various types of chronic inflammatory myopathies (Bowles *et al.*, 1987), but more recent studies using PCR have failed to demonstrate enterovirus RNA in muscle (Leff *et al.*, 1992).

Herpangina

Coxsackie virus of types A1–6, 8, 10 and 22 are associated with herpangina, which occurs most commonly in young children. The illness affects primarily children aged from 2 to 10 years and is characterized by fever, sore throat and pain on swallowing, often associated with vomiting and abdominal symptoms. Small vesicular lesions occur on the fauces, pharynx, palate, uvula and tonsils. Recovery is generally uneventful.

Exanthemata

Hand, Foot and Mouth Disease

An ulcerative exanthem of the buccal mucosa accompanied by mild fever is followed by painful vesicular lesions on the hands or feet. Less

commonly, lesions may be present on the buttocks and genitalia. Family outbreaks are common. This disease has been associated with several enteroviruses but most commonly with *Coxsackie virus A16* and less frequently, with A4, 5 and 9, and B2 and 5 (Bendig *et al.*, 1996). Enterovirus 71 has caused some outbreaks.

Rubelliform Rashes

A fine rubella-like maculopapular rash is often a feature of some Coxsackie A and echovirus infections. Most frequently *Echovirus 9* is implicated but often other echovirus serotypes and *Coxsackie virus A9* may also be involved. Summer outbreaks, most frequently affecting children, are common. Fever, malaise and cervical lymphadenopathy may also occur in patients with rash. Patients generally make an uneventful recovery.

Respiratory infections

Several enteroviruses have been associated with mild illness of the upper respiratory tract, including rhinitis, particularly during the summer and autumn. These include *Coxsackie virus A2, 10, 21* (Coe virus), 24 and B2 and 5, Coe virus has caused epidemics of pharyngitis in military recruits. Among the echoviruses which have been isolated from cases of respiratory illness are included types 1, 11, 19, 20 and 22. These viruses most commonly cause outbreaks in young children, in whom pneumonia and bronchiolitis may sometimes occur.

Myopericarditis

Coxsackie viruses B are a major cause of human myopericarditis (See and Tilles, 1991). In addition, most of the current perceptions about the mechanisms of pathogenesis in viral myocarditis derive from studies of viruses of this group and include both clinical pathology in humans and experimentally induced disease in the mouse. The clinical manifestations of enterovirus-induced myocarditis are variable. The disease is usually acute, very severe and accompanied by general pathology in the neonate. Although occasionally fulminant and fatal, it is benign commonly in adolescents and

adults. There can, however, be recrudescences of illness in the months following the acute episode and in a small proportion of patients long-term damage occurs which may lead to congestive cardiac failure. There is evidence that the virus may persist after the initial infection and lead in some cases to dilated cardiomyopathy (Muir, 1992; Andreoletti *et al.*, 1996).

Other enteroviruses such as Coxsackie viruses A and echoviruses have also been associated with myopericarditis, and their relative importance may be underestimated because of the wider availability of serological tests for Coxsackie virus B infection. However, non-picornaviruses may also cause this disease, and infiltration of the myocardium with inflammatory cells occurs during infection with a variety of viruses, including ortho- and paramyxoviruses, togaviruses, herpesviruses and adenoviruses.

Acute myopericarditis is often difficult to diagnose reliably from clinical features alone. Virological investigations play a major role in diagnosis, and include virus isolation and serological studies. Even if cardiac biopsy samples are taken early or the patient quickly dies, it is exceptionally rare to be able to isolate virus or detect virus antigen in heart tissue (Morgan-Capner *et al.*, 1984), although enterovirus RNA may be detected.

In infants, the most common cause of viral myocarditis is the Coxsackie virus B group. In neonatal Coxsackie myocarditis the pathological changes vary with the duration of illness. This disease may rapidly be fatal. In infants who die early after infection (2–5 days), left ventricular dilatation is present. The endocardium and valves are normal, even though the myocardium is pale. Late in infection (9–11 days of illness) the size of the heart is increased, largely due to dilatation of the left, and occasionally the right, ventricle. Microscopically, myofibre necrosis and inflammation are evident. Initially the inflammatory infiltrate is composed of polymorphonuclear leucocytes, but by day 5 or 6 mononuclear inflammatory cells are found.

In contrast to the abrupt, severe and often fatal disease seen in the neonatal period, viral myopericarditis in adolescents and adults usually has a delayed onset. After Coxsackie virus B infection, for example, initial symptoms are often of an upper respiratory (typically influenza-like) or gastrointestinal illness.

Acute heart disease is usually not noted until

about a week to 10 days later and has a presentation which can mimic the characteristic picture of pericarditis, coronary artery occlusion or progressive heart failure. Some patients do not present with heart disease but manifest miscellaneous symptoms and signs such as fever, myalgia and headache; often, cardiac involvement is suspected only because of typical ECG changes. The most common symptom in acute myopericarditis is chest pain, although myocarditis without pericardial involvement can be painless. Other clinical findings include tachycardia, arrhythmias, murmurs, rubs and cardiomegaly (due to ventricular dilatation or pericardial effusion). Death can supervene due to arrhythmias or congestive heart failure, but this sequela is uncommon. As in the neonatal infection, manifestations of systemic disease in adults may be noted. In Coxsackie virus B infections these include pleurodynia, meningitis, hepatitis, lymphadenopathy and splenomegaly.

Dilated Cardiomyopathy

Enteroviruses are the most commonly identified agents of acute myocarditis, and there is now strong evidence that they also cause persistent infection associated with chronic myocarditis and chronic dilated cardiomyopathy (DCM) (reviewed by Muir and Archard, 1994), a postinflammatory disease which is a significant cause of heart failure and sudden cardiac death, and one of the commonest reasons for cardiac transplantation.

Both direct virus-mediated pathology and immunopathological mechanisms may be involved in enteroviral heart disease. Infectious virus or viral antigens cannot be detected in cardiomyopathic hearts, although a proportion of patients have elevated neutralizing antibody titres (Cambridge *et al.*, 1979) and persistent enterovirus-specific IgM responses (Muir *et al.*, 1989), and viral RNA can be detected in cardiac muscle by nucleic acid hybridization (Bowles *et al.*, 1986; Kandolf *et al.*, 1990) or reverse transcriptase-PCR (Schwaiger *et al.*, 1993; Kämmerer *et al.*, 1994; Archard *et al.*, 1998). This indicates that while productive viral replication in heart tissue is curtailed before clinical presentation, the enterovirus genome persists, and failure to clear persistent virus infection may be involved in development of DCM (Why *et al.*, 1994). At present there is a lack of consensus on the most appropriate treatment for DCM. Thus while steroid therapy has

been used in patients with myocarditis, evidence of efficacy is lacking (Mason *et al.*, 1995), and concerns that immunosuppressive therapy may result in increased viral replication and consequent tissue damage remain (Kilbourne and Horsall, 1951; Heim *et al.*, 1994). Recently, small numbers of patients with myocarditis or DCM have been treated with interferon (IFN)- α , either alone or in combination with IFN- β , with evidence of viral clearance and clinical improvement in some (Figulla *et al.*, 1995; Miric *et al.*, 1996).

Characteristics of Murine Coxsackie B Viral Disease

Experimentally, Coxsackie viruses B replicate and produce inflammatory lesions in the heart, pancreas, liver, spleen and brain in several strains of mice. Studies in weanling and adult animals with Coxsackie viruses B have shown that parenteral infection results in viraemia and then replication in target organs. Viraemia is detected within 24 hours and usually persists until day 3. The virus grows in the various target organs, with maximum levels achieved by day 3 or 4. After maximum virus growth is established, virus titres decline in target organs and are usually undetectable by 7–10 days, presumably due to the induction of antibody. A number of mechanisms may be involved in the production of cardiac necrosis in myocarditis of mice, for example virus-mediated destruction of myofibres and cell-mediated pathology (Muir, 1992).

Conjunctivitis

Several types of enterovirus are associated with conjunctivitis. *Echovirus 7* and *11* and *Coxsackie virus B2* have been isolated from conjunctiva in sporadic cases. Since the early 1970s major epidemics of acute haemorrhagic conjunctivitis have been described in Africa, the Americas and the Far East. Some epidemics are due to a variant of *Coxsackie virus A24* or adenovirus 11, but many are due to enterovirus 70, a virus first identified in 1969.

Subconjunctival haemorrhage is more common with enterovirus 70 than with *Coxsackie virus A24*. There is a high attack rate amongst family members and a short incubation period of 1–2 days. Recovery is usually complete within one to two weeks and, for

Coxsackie virus A24, sequelae are rare. *Coxsackie virus A24* and enterovirus 70 can be isolated from conjunctival scrapings, and neutralizing antibody tests may be helpful.

Neurological complications may, in a few cases, accompany conjunctivitis due to enterovirus 70, and occasionally a polio-like paralytic illness ensues. One in 10 000 patients, mainly adult males, may suffer a residual paralysis. The neurological involvement may develop two or more weeks after onset of conjunctivitis. The potential for neurovirulence is a worrying feature of enterovirus 70 and this calls for vigilance in the investigation of epidemics of conjunctivitis.

Diabetes and Pancreatitis

Insulin-dependent diabetes mellitus (IDDM, or type 1 diabetes) is an autoimmune disorder in which the insulin-secreting pancreatic islet cells are progressively destroyed. The disease has an extended preclinical incubation period in which islet cell autoantibodies (ICAs) can be detected. IDDM occurs more commonly in genetically susceptible individuals, but environmental 'triggers' are also believed to play a role. Although definitive proof is lacking, seroepidemiological evidence, animal model studies and anecdotal case reports all support the hypothesis that enterovirus infections may act as such a trigger (Banatvala *et al.*, 1985). Prospective studies of siblings of IDDM cases, who themselves have an increased risk of developing IDDM, have found that individuals who subsequently develop IDDM have a higher incidence of enterovirus infections in the prediabetic phase than those who remain asymptomatic (Hyöty *et al.*, 1995). These studies also documented a temporal association between ICA seroconversion and enterovirus infection (Hiltunen *et al.*, 1997). This suggests that enterovirus infection may be involved in the initiation and progression of islet cell damage. Retrospective serological studies of maternal blood samples collected at delivery have reported a higher prevalence of enterovirus-specific IgM in mothers whose infants subsequently developed IDDM (Hyöty *et al.*, 1995), suggesting that initiation of IDDM may occur *in utero*. However enterovirus infection may also precipitate clinical IDDM onset, as suggested by the presence of enterovirus-specific IgM

or enterovirus RNA in serum in a proportion of patients at the time of clinical IDDM onset (King *et al.*, 1983; Clements *et al.*, 1995a).

Autoimmunity may arise due to molecular mimicry between viral and host antigens, and molecular mimicry between an epitope of the 2C non-structural enterovirus protein and the islet cell antigen glutamic acid decarboxylase has been demonstrated (Atkinson *et al.*, 1994). However, recent studies in IDDM-susceptible mouse strains suggest that this may be insufficient in itself to induce IDDM, and that destruction of exocrine pancreas by a pancreatotropic enterovirus infection may release sequestered islet cell antigens which restimulate autoreactive memory T cells (Horwitz *et al.*, 1998). Thus, successive enterovirus infections may result in frequent restimulation of islet cell-autoreactive T cells, resulting in cumulative loss of islet cells, which eventually culminates in clinical IDDM.

Although an acute pancreatitis is a predominant feature of Coxsackie virus B infections in mice, there is comparatively little evidence linking this disease with infection with Coxsackie viruses B in humans. However, the pancreas is often involved in generalized neonatal infection, and *Coxsackie virus B4* has occasionally been implicated as a cause of pancreatitis in adults; subclinical involvement of the pancreas has been reported in 31% and 23% of Coxsackie B5 virus and Coxsackie virus A infections (reviewed by Gamble, 1984).

Chronic Fatigue Syndrome

Chronic fatigue syndrome (CFS) has a number of alternative names: myalgic encephalomyelitis (ME), Royal Free disease, Iceland disease, post-viral fatigue syndrome and neuromyasthenia. It occurs as both sporadic and epidemic cases. Although a poorly characterized illness the cardinal feature is excess fatigability of skeletal muscle, which may be accompanied by muscle pain. Many other symptoms may be present, including headaches, inability to concentrate, paraesthesiae, impairment of short-term memory and poor visual accommodation. Focal neurological signs are rare. Evidence of myopericarditis may be present occasionally.

There have been recent attempts to produce definitions for these syndromes as many varied features

may be present (Dawson, 1990; Kyle and deShazo, 1992). Physical examination is usually not helpful although there may be some lymphadenopathy. A history of an initiating non-specific 'virus' illness may be elicited, and such a corroborated history defines postviral fatigue syndrome. Routine laboratory investigations are usually non-contributory. Some groups, however, have described abnormalities of T cell function and muscle structure (necrosis and increase in size and number of type II fibres) and function (abnormal jitter potentials and early intracellular acidosis on exercise), although these findings are not consistent (Behan *et al.*, 1985). Recovery within a few weeks or months is usual, but in some patients the syndrome persists and may be relapsing.

There is a continuing debate on the aetiology, with some considering the syndrome to have a functional origin. Much attention has focused on a viral aetiology, although it is likely that those ascribed to be suffering from the syndrome are a heterogeneous group with organic and functional components contributing in varying degree to the problem of the individual patient (Straus, 1996).

CFS occasionally follows confirmed virus infections, such as varicella/zoster, influenza A and infectious mononucleosis, and rarely bacterial and protozoal infections such as *Toxoplasma gondii* and *Leptospira hardjo*. In the majority of cases, however, the initiating viral illness cannot be diagnosed specifically.

Viruses have been implicated not only as a trigger but also as a persistent active infection. Although some cases may follow infectious mononucleosis, the serological evidence incriminating Epstein-Barr virus in a significant number of cases has been questioned (Mawle *et al.*, 1995). There is some evidence supporting a persistent enterovirus infection. In some studies, but not all, patients with CFS have a higher prevalence of elevated Coxsackie virus B neutralizing antibody titres and specific IgM compared with controls (Behan *et al.*, 1985; Mawle *et al.*, 1999). In one study, approximately 50% of patients had circulating immune complexes containing an enterovirus VP1 antigen detectable with a group-reactive monoclonal antibody. Enteroviruses were isolated only occasionally from faeces by routine methods, but were isolated from approximately 20% of patients when the faeces were acidified to disrupt virus-antibody complexes prior to cell culture (Yousef *et al.*, 1988).

These findings have not been reproduced, however, and the detection of VP1 antigen was later shown not to be able to distinguish between different groups of patients with fatigue (Lynch and Seth, 1989). Skeletal muscle biopsies from 96 patients have been examined with an enterovirus-specific DNA probe and 20 were positive (Archard *et al.*, 1988), suggesting enterovirus persistence.

Enterovirus RNA has also been detected in serum of patients with CFS (Clements *et al.*, 1995b), and the detection of near-identical viral sequences in sequential samples collected several months apart provides further evidence for persistence (Galbraith *et al.*, 1995). However, others have been unable to detect enterovirus sequences in patients with chronic fatigue syndrome (Lindh *et al.*, 1996; McArdle *et al.*, 1996).

Thus there is some evidence that in those cases of CFS with an organic origin enteroviruses may be implicated not only as a trigger but as a persisting infection. Although many treatments have been tried, such as normal human immunoglobulin, plasmapheresis and inosine pranobex, no evidence of efficacy has been presented.

LABORATORY DIAGNOSIS OF ENTEROVIRUS INFECTIONS

Virus Isolation

A combination of virus isolation and serological tests are used in attempting the diagnosis of an enterovirus infection. The most useful specimens are faecal samples or, if these are not available, rectal swabs. Virus excretion is often intermittent and more than one specimen should be collected with an interval of 24–48 hours. Faecal excretion of virus commences within a few days of infection and may continue for weeks, especially with polio and Coxsackie viruses although it rarely exceeds one month with the echoviruses. Concentrations of virus of 10^5 – 10^6 tissue culture infectious doses per gram of faeces are not uncommon.

Isolation is also possible from the pharynx during the acute phase of the illness, especially in cases with respiratory symptoms (e.g. *Echovirus 9*, *Coxsackie virus A21* and enterovirus 71). The period with the highest rate of isolation is some 5 days before to 5 days after the onset of symptoms.

Viral culture of CSF is an essential part of the routine laboratory diagnosis of aseptic meningitis.

Although polioviruses are infrequently detected in the CSF, in certain echovirus epidemics up to 80% of CSF specimens yield virus. Detection of enteroviruses in a normally virologically sterile body fluid is of considerably more significance than merely detecting it in faeces or nasopharyngeal secretions. Thus apparently healthy infants and children may excrete enteroviruses: indeed, in those parts of the tropics in which faecal contamination of the environment is common, up to 40% of children up to the age of 2 years may excrete enteroviruses. Also, those who have been recently immunized with live attenuated poliovirus vaccine are likely to excrete virus from the upper respiratory tract and faeces for some time. Thus the possible significance of isolating poliovirus can only be assessed knowing the vaccine history and clinical features.

In fatal cases, autopsy specimens of brain and spinal cord are useful, especially in those where there is association with the use of oral polio vaccine, where investigations of the origin of the strain may be required.

Polioviruses, Coxsackie viruses B, echoviruses and some Coxsackie viruses A (such as A9 and A16) are readily isolated in cell cultures prepared from the kidneys of rhesus, cynomolgus or cercopithecus monkeys. Other useful cultures can be obtained from human embryo kidney and amnion, or strains of diploid cells from human fetal lung. Possibly the most generally useful regimen is the inoculation of cell cultures of primary monkey kidney and human embryo lung fibroblasts. Enteroviruses cannot be readily distinguished by their growth in cell cultures, as all produce a similar cytopathic effect (CPE). The tissue cells become rounded, refractile and ultimately shrink before detaching from the cell surface. Once a cytopathic agent has been isolated in cell culture, serological tests must be performed to identify the type. Because of the number of potential strains, neutralization tests using individual type-specific sera are not satisfactory and it is usual to employ either a single-stage procedure using antiserum pools containing selected antisera (Melnick, 1979) or a two-step method first identifying the isolate as belonging to one of four groups followed by a second test to identify the type.

Some enteroviruses, notably most of the Coxsackie virus A group, are not readily detected in cell cultures: if a Coxsackie virus A infection is suspected, specimens should be injected into two or more litters of mice by intracerebral, intraperitoneal and

subcutaneous routes. The group A viruses induce a general myositis of striated muscle, causing flaccid paralysis and death. The B group cause areas of degeneration in the brain and skeletal muscle and spastic paralysis, but the most characteristic feature is necrosis of brown fat. Neither polio nor echoviruses can be isolated in mice.

Twelve of the echoviruses possess the ability to agglutinate human group O erythrocytes. This activity is integral to the viral particle; spontaneous elution may occur at 37°C but this does not destroy the cell receptors, a property which differentiates the echoviruses from the ortho- and paramyxoviruses. The presence of haemagglutination activity helps reduce the number of possibilities when attempting to identify an enterovirus strain.

Serological Techniques in Diagnosis

Neutralization tests are generally employed for such seroepidemiological purposes as determining the exposure and immunity of a population group to different enteroviruses, including responses to polio vaccination. These tests are labour intensive and results are seldom available in less than three to four days. Poliovirus and Coxsackie virus B are the only enteroviruses for which neutralization tests are readily available. Antibody titres are compared in paired sera, the first being collected within 5 days of onset of symptoms, and the second some days later. Significant rises in antibody titre are detected only occasionally and this has led to significance being attached to elevated neutralizing antibody titres. Elevated titres frequently occur, however, in normal individuals so do not confirm recent infection. Significant antibody rises are particularly rare in cardiac disease, probably because cardiac events are a relatively late consequence of Coxsackie virus B infection.

More recently, serological diagnosis of recent Coxsackie virus B infection has been achieved by detecting Coxsackie virus B-specific IgM using M-antibody capture techniques (Bell *et al.*, 1986). These assays have also been developed for particular echovirus and Coxsackie virus A serotypes. Cross-reactivity between the IgM responses to different enteroviruses, including hepatitis A, occurs. Consequently a positive result with a Coxsackie virus B-specific IgM assay does not necessarily indi-

cate a recent Coxsackie virus B infection but may reflect recent infection with another enterovirus serotype. The older the patient, the more likely that such heterotypic responses will occur. Enterovirus-specific IgM responses generally last for 8–12 weeks, but in some patients may persist for much longer, occasionally for some years. It has been suggested that such a prolonged response in, for instance, cases of recurrent pericarditis, may indicate persistence of the infecting enterovirus. Approximately 30–40% of patients with myocarditis, 60–70% of patients with aseptic meningitis and 30% of patients with postviral fatigue syndrome give positive results for Coxsackie virus B-specific IgM. However, approximately 10% of normal adults also give a positive result, perhaps having experienced a recent enterovirus infection.

Enzyme immunoassays have also been employed to detect enterovirus-specific IgG, which usually appears about 7 days after the onset of symptoms and precedes the virus-specific IgM response. A rising titre of IgG antibody to polioviruses must be treated with caution, as type 1 or type 3 infections may produce a significant boost to type 2 antibody in individuals previously primed to this type (Melnick, 1979).

Complement fixation tests have also been used for serological diagnosis. However, there is a high frequency of cross-reactions between different members of the group. As with the serum neutralization test, a rising complement-fixing-antibody titre may provide a presumptive diagnosis to support the results of virus isolation tests.

Genome Detection

DNA probes made by reverse transcription of purified Coxsackie virus B genome RNA have been prepared and used to detect enterovirus RNA in infected cell cultures, infected mice and human tissue biopsies. Although prepared against a single Coxsackie virus B serotype, the probes have been complementary to RNA sequences which are highly conserved amongst enteroviruses and are thus group specific, with the exception of *Echovirus 22*. They have been used to detect enterovirus RNA both in tissue extracts and by *in situ* hybridization. Enterovirus RNA has been detected in myocardial biopsies from

patients with myocarditis and dilated cardiomyopathy, inflammatory muscle disease (Bowles *et al.*, 1987), postviral fatigue syndrome (Archard *et al.*, 1988) and brain (Hallam *et al.*, 1986). As most of the patients sampled had had symptoms for a considerable time, the positive results are highly suggestive that enterovirus genomes may persist, although infectious virus is almost never isolated from the tissue and in recent studies virus antigen has never been detected.

PCR is technically more straightforward and quicker than nucleic acid hybridization methods, and is therefore more suitable for viral diagnosis. Identification of extremely conserved sequences within the 5' non-coding region of the enterovirus genome has allowed the design of PCR primers which allow detection of most enteroviruses (Hyypiä *et al.*, 1989; Chapman *et al.*, 1990; Rotbart, 1990). Numerous studies have shown that enterovirus PCR is more sensitive than viral culture for detection of enteroviruses in clinical specimens. Enterovirus PCR is useful for diagnosis of enterovirus myocarditis (Martin *et al.*, 1994; Nicholson *et al.*, 1995). In many diagnostic laboratories examination of CSF by enterovirus PCR is now replacing virus isolation for diagnosis of enteroviral meningitis, raising the possibility of more rapid diagnosis, which in turn may have greater impact on patient treatment (Schelsinger *et al.*, 1994). Unfortunately most enterovirus PCR protocols do not allow serotypic identification. Although serotypic identification is usually of less clinical urgency, the ability to differentiate polio and non-polio enteroviruses is important for investigation of suspected poliomyelitis cases, for diagnosis of non-polio enterovirus infection in patients recently vaccinated with live polio vaccine, and for monitoring wild poliovirus circulation in endemic regions. A molecular typing system which complemented molecular diagnosis would probably require primers and probes directed against capsid-coding regions which determine the virus serotype (Muir *et al.*, 1998). No such system has been developed to date. However a number of PCR methods have been described for discrimination between polio and non-polio enteroviruses (Abraham *et al.*, 1993), group or serotypic identification of polioviruses (Kilpatrick *et al.*, 1996), or intratypic differentiation of wild and vaccine-strain polioviruses (Yang *et al.*, 1991).

PREVENTION OF ENTEROVIRUS INFECTIONS

Echovirus and Coxsackie Virus infections

Vaccination is not available against illnesses caused by echo- and Coxsackie viruses. The multiplicity of antigenic types and the usually selectively mild nature of the diseases make the production of vaccines impractical. The only effective measures for their control are high standards of personal and community hygiene. Quarantine is not effective because of the high frequency of inapparent infections.

Poliovirus Infections

The observation that there are only three polio virus types and the discovery that they will grow in cell cultures of non-nervous tissue from monkeys made possible the development of vaccines against poliomyelitis. By 1954, some 12 000 volunteers had been vaccinated with a formalin-inactivated suspension of polioviruses developed by Dr Jonas Salk in the USA. Dr Albert Sabin and others adopted a different approach and developed attenuated strains of the three poliovirus types capable of inducing immunity by the oral route.

Natural infection with polioviruses is by the oral route and results in viral replication in the mucosa of the pharynx and alimentary tract, causing viraemia and stimulating virus-specific IgA and IgG. The route by which the virus gains access to the CNS is not clear; although there is some experimental evidence that the virus may reach the CNS by travelling along autonomic nerve pathways from the site of replication, the greater body of evidence suggests that invasion of the CNS occurs via the bloodstream and may be prevented by circulating antibody.

Inactivated Poliovirus Vaccine

The inactivated vaccine for parenteral injection (IPV) has been used extensively in Sweden, Finland, Iceland and Holland and, with acceptance rates of 90% or better, has virtually eliminated poliomyelitis. Surveys also show that the circulation of po-

liovirus in the community has been dramatically reduced despite the fact that the vaccine does not induce detectable levels of secretory IgA and, in theory, would not be expected to prevent alimentary tract infections. Sabin has argued that the absence of polioviruses in countries using IPV is due to the use of OPV in neighbouring countries (Sabin, 1982) but studies in Holland and Sweden have shown that during widespread infection of members of religious sects refusing vaccination there was little virus circulation in the surrounding community with which they were in contact (Bijerk, 1981; Bottiger, 1981).

It has been observed that the pattern of virus shedding following virus infection of children previously vaccinated with IPV was related to the antibody titre at the time of infection. The presence of detectable IgG reduced pharyngeal shedding from 75% to 33% of children but faecal shedding was reduced only when the titre of antibody was high, in excess of 1/128. The high standards of hygiene in Holland and Scandinavia, where pharyngeal shedding of poliovirus is probably the major source of infection, may explain the success of IPV in these countries.

A small outbreak of poliomyelitis with wide circulation of the type 3 strains occurred in Finland, a country which had relied exclusively on IPV and in which poliomyelitis had been unknown for 20 years. The level of type 3 antibody in the community was known to be low and the absence of poliomyelitis was attributed to persisting immunological memory since revaccination of seronegative individuals induced rapid boosterlike responses. The poliovirus strains isolated in the outbreak were antigenically unusual and, in comparison with other type 3 poliovirus strains, less well neutralized by antisera to reference strains of type 3 virus (Magrath *et al.*, 1986).

The spread of the type 3 strain in Finland may have resulted from the unusual antigenic structure of the virus, which resulted in its being poorly recognized with consequent delayed development of a booster response in many infected subjects, with low initial serum titres. The age of modern high potency vaccines is likely to prevent this in future.

Live Attenuated Poliovirus Vaccine Administered Orally

The availability in the early 1960s of the live attenuated vaccine, which was cheaper to produce and administer, easier to manufacture in quantity and which had some theoretical advantages over inactivated vaccine, led to its rapid adoption worldwide. The vaccine administered by the oral route parallels the natural infection and stimulates both local secretory IgA in the pharynx and alimentary tract and circulating IgG. Virus is excreted in the faeces for several weeks and possibly for several days in pharyngeal secretions. During this period the vaccine may spread to close contacts, inducing or boosting immunity in them.

Until relatively recently live vaccine was administered as part of ongoing vaccination programmes, such that individuals received vaccine as they reach specific ages, typically in the UK 2, 4 and 6 months. This strategy was extremely effective in developed countries in reducing the incidence of paralytic poliomyelitis to essentially zero, but in other countries it had very little impact.

There have been reports which have shown that children in warm climates who have been given oral polio vaccine (OPV) often respond poorly; indeed, cases of paralytic poliomyelitis have been reported in infants who had received a full course of OPV. Interference by other enteroviruses in the gut, presence of inhibitors in gastrointestinal secretions and suppression of the immune response by maternal antibody are among mechanisms which have been proposed. However, it is more likely that failure to control poliomyelitis in developing countries is due partly to failure to reach a sufficiently high proportion of the target population and partly to the use of vaccine which has lost its potency.

These difficulties have been countered by the use of national immunization days (NIDs) in which the aim is to immunize all children under the age of 5 in a country or region within a short period, usually a few days, and then to repeat the process a few weeks later. This results in a higher coverage with fresh vaccine, and the colonization of susceptible individuals with vaccine virus, so breaking transmission. The strategy, which is usually run in parallel with the programmed strategy used elsewhere, has resulted in the eradication of poliomyelitis in the Americas, where the last case due to wild-type po-

liovirus was seen in 1992, in Peru, and made extraordinary inroads in the western Pacific region, India and Pakistan and Africa. (Expanded Programme on Immunization, 1998) The World Health Organization (WHO) has declared its intention of eliminating poliomyelitis due to wild-type poliovirus from the world by the year 2000, and it is likely that the goal will be achieved close to this date. One index of success in controlling transmission comes from molecular analysis of isolates which can be classified into different genotypes, which disappear one by one as transmission is broken and they die out. Type 2 poliovirus is completely eliminated first, followed by type 1 and then type 3.

The success of the eradication programme has focused attention on the few cases of poliomyelitis apparently caused by the vaccine (WHO, 1976). In the years 1978–1983 in the USA there were 69 reported cases of poliomyelitis. Virus isolated from 35 cases was studied. Seven cases were classified as epidemic and three as endemic, with no known association with the administration of OPV; all the viruses were classified as wild by strain-specific neutralization tests. Virus isolates from the remaining 25 cases, all of which occurred in recipients or contacts of OPV, were all considered to be vaccine-derived strains by the same test methods. WHO has estimated the risk of vaccine-associated poliomyelitis at between 0.5 and 3.4 cases per million of susceptible children immunized. Nkowane *et al.* (1987) estimated the risk in the USA as 1 per 530 000 primary vaccinees and 1 per 2×10^6 overall. Cases associated with the type 1 strain are tenfold less than with the type 2 and type 3 strain taken together. This incidence should be taken in the context of more than 10 000 cases per annum in the USA before the use of vaccines.

Thus a time will come when poliomyelitis will only be caused by the vaccine, raising the question of how vaccination can be safely stopped in view of the excretion of virus, which may be prolonged, especially in the case of hypogammaglobulinaemic individuals who may shed virus for several years.

One view is that vaccination may simply cease, as vaccine virus is relatively poorly transmissible and it will therefore die out faster than susceptibles build up. A second view is that there is a role for inactivated poliovaccine. The matter is currently the subject of debate.

Future prospects

Poliomyelitis is the most significant disease currently caused by a human enterovirus, and enormous progress has been made towards its eradication. It is anticipated that complete eradication of disease caused by the wild-type virus will be achieved in the near future. Other enteroviruses remain, and their contribution to human disease, including long-term effects, continues to be evaluated.

REFERENCES

- Abraham, R., Chonmaitree, T., McCombs, J. *et al.* (1993) Rapid detection of poliovirus by reverse transcription and polymerase chain reaction amplification: application for differentiation between poliovirus and nonpoliovirus enteroviruses. *Journal of Clinical Microbiology*, **31**, 395.
- Absug, J.M., Keyserling, H.L., Lee, M.L. *et al.* (1995) Neonatal enterovirus infection: virology, serology and effects of intravenous immune globulin. *Clinical Infectious Diseases*, **20**, 1201–1206.
- Alexander, J.P., Baden, L., Pallansch, M.A. *et al.* (1994) Enterovirus 71 infections and neurological disease. United States 1987–1991. *Journal of Infectious Diseases*, **169**, 905–908.
- Andreoletti, L., Hober, D., Decone, C. *et al.* (1996) Detection of enteroviral RNA by polymerase chain reaction in endo-myocardial tissue of patients with chronic cardiac diseases. *Journal of Medical Virology*, **48**, 53–59.
- Archard, L.C., Bowles, N.E., Behan, P.O. *et al.* (1988) Postviral fatigue syndrome: persistence of enterovirus RNA in muscle and elevated creatinine kinase. *Journal of the Royal Society of Medicine*, **81**, 326.
- Archard, L.C., Khan, M.A., Soteriou, B.A. *et al.* (1998) Characterisation of coxsackie B virus RNA in myocardium from patients with dilated cardiomyopathy by nucleotide sequencing of reverse-transcription-nested polymerase chain reaction products. *Human Pathology*, **29**, 578.
- Atkinson, M., Bowman, M.A., Campbell, L. *et al.* (1994) Cellular immunity to a determinant common to glutamate decarboxylase and coxsackie virus in insulin-dependent diabetes. *Journal of Clinical Investigation*, **94**, 2125.
- Banatvala, J.E., Scherthaner, G., Schober, E. *et al.* (1985) Coxsackie B, mumps, rubella and cytomegalovirus specific IgM responses in patients with juvenile-onset insulin-dependent diabetes mellitus in Britain, Austria and Australia. *Lancet*, **i**, 1049.
- Behan, P.O., Behan, W.M.H. and Bell, E.J. (1985) The postviral fatigue syndrome: an analysis of the findings in 50 cases. *Journal of Infection*, **10**, 211.
- Bell, E.J., McCartney, R.A. and Banatvala, J.E. (1986) The routine use of μ -antibody capture ELISA for the serological diagnosis of Coxsackie B virus infections. *Journal of Medical Virology*, **19**, 205.
- Bendig, J.W.A. and Fleming, D.M. (1996) Epidemiological virological and clinical features of an epidemic hand, foot and mouth disease in England and Wales. *Communicable Disease*

- Report CDR, 6, R81–86.
- Bendinelli, M. and Friedman, H. (eds) (1988) *Coxsackieviruses: A General Update*. Plenum Press, New York.
- Bergelson, J.M., Shepley, M.P., Chan, B.M.C. *et al.* (1992) Identification of the integrin VLA-2 as a receptor for echovirus 1. *Science*, **255**, 1718.
- Bergelson, J.M., Chan, M., Solomon, K. *et al.* (1994) Decay-accelerating factor (CD55), a glycosylphosphatidylinositol-anchored complement regulation protein, is a receptor for many echoviruses. *Proceedings of the National Academy of Sciences of the USA*, **91**, 6245.
- Bergelson, J.M., Cunningham, J.A., Droguett, G. *et al.* (1997) Isolation of a common receptor for coxsackie B viruses and adenoviruses 2 and 5. *Science*, **275**, 1320.
- Bijerk, H. (1981) Poliomyelitis in the Netherlands. *Developments in Biological Standardisation*, **47**, 233.
- Bottiger, M.A. (1981) Experiences of vaccination with inactivated poliovirus vaccine in Sweden. *Developments in Biological Standardisation*, **47**, 227.
- Bowles, N.E., Richardson, P.J., Olsen, E.G.J. *et al.* (1986) Detection of coxsackie-B-virus-specific RNA sequences in myocardial biopsy samples from patients with myocarditis and dilated cardiomyopathy. *Lancet*, **i**, 1120.
- Bowles, N.E., Dubowitz, V., Sewry, C.A. *et al.* (1987) Dermatomyositis, polymyositis and coxsackie-B-virus infection. *Lancet*, **i**, 1004.
- Cambridge, G., MacArthur, C.G.C., Waterson, A.P. *et al.* (1979) Antibodies to coxsackie B viruses in primary congestive cardiomyopathy. *British Heart Journal*, **41**, 692.
- Chapman, N.M., Tracy, S., Gauntt, C.J. *et al.* (1990) Molecular detection and identification of enteroviruses using enzymatic amplification and nucleic acid hybridization. *Journal of Clinical Microbiology*, **28**, 843.
- Chow, M., Newman, J.F.E., Filman, D. *et al.* (1987) Myristylation of picornavirus capsid protein VP4 and its structural significance. *Nature*, **327**, 482.
- Christie, A.B. (1987) *Infectious Diseases: Epidemiology and Clinical Practice*, 4th edn, vol. 2. Churchill Livingstone, Edinburgh.
- Clements, G.B., Galbraith, D.N. and Taylor, K.W. (1995a) Coxsackie B virus infection and onset of childhood diabetes. *Lancet*, **346**, 221–3.
- Clements, G.B., McGarry, F., Nairn, C. *et al.* (1995b) The detection of enterovirus specific RNA in serum: the relationship to chronic fatigue. *Journal of Medical Virology*, **45**, 151.
- Dalldorf, G. and Sickles, G.M. (1948) An unidentified filtrable agent isolated from the faeces of children with paralysis. *Science*, **108**, 61.
- da Silva, E.E., Winkler, M.T. and Pallansch, M.A. (1996) Role of enterovirus 71 in acute flaccid paralysis after the eradication of poliovirus in Brazil. *Emerging Infectious Diseases*, **2**, 231.
- Dawson, J. (1990) Consensus on research into fatigue syndrome. *Lancet*, **300**, 832.
- Enders, J.F., Weller, T.H. and Robbins, F.C. (1949) Cultivation of the Lansing strain of poliomyelitis virus in cultures of various human embryonic tissues. *Science*, **109**, 85.
- Expanded Programme on Immunization (EPI) (1998) Progress towards global poliomyelitis eradication, 1988–1997. *Weekly Epidemiological Record*, **73**, 161.
- Figulla, H.R., Stille-Siegner, M., Mall, G. *et al.* (1995) Myocardial enterovirus infection with left ventricular dysfunction: a benign disease compared with idiopathic dilated cardiomyopathy. *Journal of the American College of Cardiology*, **25**, 1170.
- Galbraith, D.N., Nairn, C. and Clements, G.B. (1995) Phylogenetic analysis of short enteroviral sequences from patients with chronic fatigue syndrome. *Journal of General Virology*, **76**, 1701.
- Gamble, D.R. (1984) Enteroviruses: polio-, echo-, and Coxsackieviruses. In *Topley and Wilson's Principles of Bacteriology, Virology and Immunity*, 7th edn, vol. 4 (eds G. Wilson, A. Miles and M.T. Parker), pp 394–419. Edward Arnold, London.
- Gear, J.H.S. and Measroch, V. (1973) Coxsackievirus infections of the newborn. *Progress in Medical Virology*, **15**, 46.
- Hallam, N.F., Eglin, R.P., Holland, P. *et al.* (1986) Fatal coxsackie B meningoencephalitis diagnosed by serology and *in situ* nucleic acid hybridization. *Lancet*, **ii**, 1213.
- Heim, A., Stille-Siegner, M., Kandolf, R. *et al.* (1994) Enterovirus-induced myocarditis: hemodynamic deterioration with immunosuppressive therapy and successful application of interferon-alpha. *Clinical Cardiology*, **17**, 563–565.
- Helfand, R.F., Gary, H.E., Freeman, C.Y. and the Pittsburgh Diabetes Research Group, Pallansch, MA (1995) Serologic evidence of an association between enteroviruses and the onset of type 1 diabetes mellitus. *Journal of Infectious Diseases*, **172**, 1206–11.
- Hiltunen, M., Hyöty, H., Knip, M. *et al.* (1997) Islet cell antibody seroconversion in children is temporally associated with enterovirus infections. Childhood Diabetes in Finland (DiMe) Study Group. *Journal of Infectious Diseases*, **175**, 554.
- Hogle, J.M., Chow, M. and Filman, D.J. (1985) The three dimensional structure of poliovirus at 2.9 Å resolution. *Science*, **229**, 1358.
- Horwitz, M.S., Bradley, L.M. and Harbertson, J. (1998) Diabetes induced by coxsackie virus: initiation by bystander damage and not molecular mimicry. *Nature Medicine*, **4**, 781.
- Hyöty, J., Hiltunen, M., Knip, M. *et al.* (1995) A prospective study of the role of coxsackie B and other enterovirus infections in the pathogenesis of IDDM. Childhood Diabetes in Finland (DiMe) Study Group. *Diabetes*, **44**, 652.
- Hyypiä, T., Auvinen, P. and Maaronen, M. (1989) Polymerase chain reaction for human picornaviruses. *Journal of General Virology*, **70**, 3261.
- Hyypiä, T., Hovi, T., Knowles, N.J. *et al.* (1997) Classification of enteroviruses based on molecular and biological properties. *Journal of General Virology*, **78**, 1.
- Jeffery, K.J.M., Read, S.J., Peto, T.E.A. *et al.* (1997) Diagnosis of viral infections of the central nervous system: clinical interpretation of PCR results. *Lancet*, **349**, 313–317.
- Kämmerer, U., Kunkel, B. and Korn, K. (1994) Nested polymerase chain reaction for specific detection and rapid identification of human picornaviruses. *Journal of Clinical Microbiology*, **32**, 285.
- Kandolf, R., Canu, A., Klingel, K. *et al.* (1990) Molecular studies on enteroviral heart disease. In *New Aspects of Positive Strand RNA Viruses* (eds M.A. Brinton and F.X. Heinz), pp 340–348. American Society for Microbiology, Washington DC.
- Karnauchow, T.M., Tolson, D.L., Harrison, B.A. *et al.* (1996) The HeLa cell receptor for enterovirus 70 is decay-accelerating factor (CD55). *Journal of Virology*, **70**, 5143.
- Katrak, K., Mahon, B., Minor, P.D. *et al.* (1991) Cellular and humoral immune responses to poliovirus in mice: a role for

- helper T cells in heterotypic immunity to poliovirus. *Journal of General Virology*, **72**, 1093.
- Kilbourne, E.D. and Horsfall, F.L. (1971) Lethal infection with coxsackievirus of adult mice given cortisone. *Proceedings of the Society for Experimental Biology and Medicine*, **77**, 135.
- Kilpatrick, D.R., Nottay, B., Yang, C.-F. *et al.* (1996) Group-specific identification of polioviruses by PCR using primers containing mixed-base or deoxyinosine residues at positions of codon degeneracy. *Journal of Clinical Microbiology*, **34**, 2990.
- King, M.L., Shaikh, A., Bidwell, D. *et al.* (1983) Coxsackie-B-virus-specific IgM response in children with insulin dependent (juvenile-onset, type I) diabetes mellitus. *Lancet*, **i**, 1397.
- Koike, S., Taya, C., Kurata, T. *et al.* (1991) Transgenic mice susceptible to poliovirus. *Proceedings of the National Academy of Sciences of the USA*, **88**, 951.
- Kyle, D.V. and deShazo, R.D. (1992) Chronic fatigue syndrome: a conundrum. *American Journal of the Medical Sciences*, **303**, 38.
- Leff, R.L., Love, L.A., Miller, F.W. *et al.* (1992) Viruses in idiopathic inflammatory myopathies: absence of candidate viral genomes in muscle. *Lancet*, **339**, 1192.
- Leparc-Goffart, I., Julien, J., Fuchs, F. *et al.* (1996) Evidence of presence of poliovirus genomic sequences in cerebrospinal fluid from patients with postpolio syndrome. *Journal of Clinical Microbiology*, **34**, 2023.
- Lindh, G., Samuelson, A., Hedlund, K.O. *et al.* (1996) No findings of enteroviruses in Swedish patients with chronic fatigue syndrome. *Scandinavian Journal of Infectious Diseases*, **28**, 305.
- Lynch, S. and Seth, R. (1989) Postviral fatigue syndrome and the VP-1 antigen. *Lancet*, **ii**, 1160.
- McArdle, A., McArdle, F., Jackson, M.J. *et al.* (1996) Investigation by polymerase chain reaction of enteroviral infection in patients with chronic fatigue syndrome. *Clinical Science*, **90**, 295.
- Magrath, D.I., Evans, D.M.A., Ferguson, M. *et al.* (1986) Antigenic properties of type 3 poliovirus responsible for an outbreak of poliomyelitis in a vaccinated population. *Journal of General Virology*, **67**, 899.
- Martin, A.B., Webber, S., Fricker, F.J. *et al.* (1994) Acute myocarditis. Rapid diagnosis by PCR in children. *Circulation*, **90**, 330.
- Mason, J.W., O'Connell, J.B., Herskowitz, S. *et al.* (1995) A clinical trial of immunosuppressive therapy for myocarditis. *New England Journal of Medicine*, **333**, 269–275.
- Mawle, A.C., Nisenbom, R., Dobbins, J.-G. *et al.* (1995) Seroepidemiology of chronic fatigue syndrome: a case control study. *Clinical Infectious Diseases*, **21**, 1386–1389.
- Melnick, J.L. (1979) *Diagnostic Procedures for Viral, Rickettsial and Chlamydial Infections*, 5th edn, p 471. American Public Health Association, Washington, DC.
- Melnick, J.L. (1990) Enteroviruses: polioviruses, coxsackieviruses, echoviruses, and newer enteroviruses. In *Virology*, 2nd edn (eds B.N. Fields and D.M. Knipe), p 549. Raven Press, New York.
- Melnick, J.L. (1996) Enteroviruses: polioviruses, coxsackieviruses, echoviruses, and newer enteroviruses. In *Fields Virology*, 3rd edn (eds B.N. Fields, D.M. Knipe, P.M. Howley *et al.*), pp 655–712. Lippincott-Raven, Philadelphia.
- Mendelsohn, C., Wimmer, E. and Racaniello, V.R. (1989) Cellular receptor for poliovirus: molecular cloning, nucleotide sequence and expression of a new member of the immunoglobulin superfamily. *Cell*, **56**, 855.
- Minor, P.D. (1990) Antigenic structure of picornaviruses. *Current Topics in Microbiology and Immunology*, **161**, 122.
- Minor, P.D. (1996) Poliovirus. In *Viral Pathogenesis* (eds N. Nathanson, R. Ahmed, F. Gonzalez-Scarano *et al.*), pp 555–574. Lipincott-Raven, Philadelphia.
- Minor, P.D., Pipkin, P.A., Hockley, D. *et al.* (1984) Monoclonal antibodies which block cellular receptors of poliovirus. *Virus Research*, **1**, 203.
- Minor, P.D., Brown, F., King, A. *et al.* (1991) Fifth report of the Picornaviridae Study Group. In *Classification and Nomenclature of Viruses*. Fifth Report of the International Committee on Taxonomy of Viruses (eds R.I.B. Francke, C.M. Fauquet, D.L. Krudin *et al.*) *Archives of Virology Supplement*, **2**, 322.
- Minor, P., Brown, F., Domingo, E. *et al.* (1995) *Picornaviridae*. In *Virus Taxonomy. Classification and Nomenclature of Viruses*. Sixth Report of the International Committee on Taxonomy of Viruses Virology Division, International Union of Microbiological Societies. (eds F.A. Murphy, C.M. Fauquet, D.H.L. Bishop, *et al.*).
- Modlin, J.F. (1988) Echovirus infections of newborn infants. *Journal of Paediatric Infectious Diseases*, **7**, 311.
- Morgan-Capner, P., Richardson, P.J., McSorley, C. *et al.* (1984) Virus investigations in heart muscle disease. In *Viral Heart Disease* (ed. H.D. Bolte), pp 99–115. Springer-Verlag, Berlin.
- Muckelbauer, J.K., Kremer, M., Minor, I. *et al.* (1995) The structure of coxsackievirus B3 at 3.5 Å resolution. *Structure*, **3**, 653.
- Muir, P. (1992) The association of enteroviruses with chronic heart disease. *Reviews in Medical Virology*, **2**, 9.
- Muir, P. and Archard, L.C. (1994) There is evidence for persistent enterovirus infections in chronic medical conditions in humans. *Reviews in Medical Virology*, **4**, 245.
- Muir, P. and van Loon, A.M. (1997) Enterovirus infections of the central nervous system. *Intervirology*, **40**, 153.
- Muir, P., Nicholson, F., Tilzey, A.J. *et al.* (1989) Chronic relapsing pericarditis and dilated cardiomyopathy: serological evidence of persistent enterovirus infection. *Lancet*, **i**, 804.
- Muir, P., Nicholson, F., Spencer, G.T. *et al.* (1996) Enterovirus infection of the central nervous system of humans; lack of association with chronic neurological disease. *Journal of General Virology*, **77**, 1469.
- Muir, P., Kämmerer, U., Korn, K. *et al.* (1998) Molecular typing of enteroviruses: current status and future requirements. *Clinical Microbiology Reviews*, **11**, 202.
- Munsat, T.L. (1991) Poliomyelitis: new problems with an old disease. *New England Journal of Medicine*, **324**, 1206.
- Nicholson, F., Ajetunmobi, J.F., Li, M. *et al.* (1995) Molecular detection and serotypic analysis of enterovirus RNA in archival specimens from patients with acute myocarditis. *British Heart Journal*, **74**, 522.
- Nkowane, B.M., Wassilak, S.G., Oversteen, W.A. *et al.* (1987) Vaccine associated paralytic poliomyelitis in the United States: 1973 through 1984. *JAMA*, **257**, 1335.
- Pelletier, J. and Sonnenberg, N. (1988) Internal initiation of translation of eukaryotic mRNA directed by a sequence derived from poliovirus RNA. *Nature*, **334**, 320.
- Pöyry, T., Kinnunen, L., Hyypiä, T. *et al.* (1996) Genetic and phylogenetic clustering of enteroviruses. *Journal of General Virology*, **77**, 1699.
- Ren, R., Costantini, F.C., Gorgaev, E.J. *et al.* (1990) Transgenic mice expressing a human poliovirus receptor: a new model for

- poliomyelitis. *Cell*, **63**, 353.
- Rossmann, M.G., Arnold, E., Erickson, J.W. *et al.* (1985) Structure of a common cold virus and functional relationship to other picornaviruses. *Nature*, **317**, 145.
- Rotbart, H.A. (1990) Enzymatic RNA amplification of the enteroviruses. *Journal of Clinical Microbiology*, **28**, 438.
- Rotbart, H.A. (ed.) (1995a) *Human Enterovirus Infections*. ASM Press, Washington DC.
- Rotbart, H.A. (1995b) Enteroviral infections of the central nervous system. *Clinical Infectious Diseases*, **20**, 971–981.
- Rueckert, R.R. and Wimmer, E. (1984) Systematic nomenclature of picornavirus proteins. *Journal of Virology*, **50**, 957.
- Sabin, A.B. (1982) Vaccine control of poliomyelitis in the 1980s. *Journal of Biology and Medicine*, **55**, 383.
- Schlesinger, Y., Sawyer, M.H. and Storch, G.A. (1994) Enteroviral meningitis in infancy: potential for polymerase chain reaction in patient management. *Pediatrics*, **94**, 157.
- Schwaiger, A., Umlauf, F., Weyrer, K. *et al.* (1993) Detection of enterovirus ribonucleic acid in myocardial biopsies from patients with idiopathic dilated cardiomyopathy by polymerase chain reaction. *American Heart Journal*, **126**, 406.
- See, D.M. and Tilles, J.G. (1991) Viral myocarditis. *Reviews in Infectious Diseases*, **13**, 951.
- Shafren, D.R., Bates, R.C., Agrez, M.V. *et al.* (1995) Coxsackievirus B1, B3, and B5 use decay-accelerating factor as a receptor for cell attachment. *Journal of Virology*, **69**, 3873.
- Stanway, G. (1990) Structure, function and evolution of picornaviruses. *Journal of General Virology*, **71**, 2483–2501.
- Straus, S.E. (1996) Chronic fatigue syndrome. *BMJ*, **313**, 831–832.
- Tracy, S., Chapman, N.M. and Beck, M.A. (1991) Molecular biology and pathogenesis of coxsackie B viruses. *Reviews in Medical Virology*, **1**, 145.
- Uhlig, J., Wieggers, K. and Dernick, R. (1990) A new antigenic site of poliovirus recognised by an intertypic cross-neutralizing monoclonal antibody. *Virology*, **178**, 606.
- Ward, T., Pippin, P.A., Clarkson, N.A. *et al.* (1994) Decay accelerating factor CD55 is identified as the receptor for echovirus 7 using CELICS, a rapid immuno-focal cloning method. *EMBO Journal*, **13**, 5070–5074.
- WHO (1976) The relation between acute persisting spinal paralysis and poliomyelitis vaccine (oral): results of a WHO enquiry. *Bulletin of the World Health Organization*, **53**, 319.
- Why, H.J.F., Meany, B.T., Richardson, P.J. *et al.* (1994) Clinical and prognostic significance of detection of enteroviral RNA in the myocardium of patients with myocarditis or dilated cardiomyopathy. *Circulation*, **89**, 2582.
- Wilfert, C.M., Buckley, R.H., Mohanakumar, T. *et al.* (1977) Persistent and fatal central nervous system echovirus infections in agammaglobulinaemia. *New England Journal of Medicine*, **296**, 1485.
- Woodall, C.J., Riding, M.H., Graham, D.I. *et al.* (1994) Sequences specific for enteroviruses detected in spinal cord from patients with motor neurone disease. *BMJ*, **308**, 1541.
- Yang, C.F., De, L., Holloway, B.P. *et al.* (1991) Detection and identification of vaccine-related polioviruses by the polymerase chain reaction. *Virus Research*, **20**, 159.
- Yousef, G.E., Mann, G.F., Brown, I.N. *et al.* (1987) Clinical and research application of an enterovirus group-reactive monoclonal antibody. *Intervirology*, **28**, 199.
- Yousef, G.E., Bell, E.J., Mann, G.F. *et al.* (1988) Chronic enterovirus infection in patients with post-viral fatigue syndrome. *Lancet*, **i**, 146.

Poxviruses

Derrick Baxby

University of Liverpool, Liverpool, UK

INTRODUCTION

This chapter deals only with those poxviruses which cause human infection. The last case of smallpox occurred over 20 years ago, and the remaining human poxvirus infections are relatively unimportant, although occasional severe infection and even death may occur. With the exception of molluscum contagiosum, human poxvirus infections are acquired from animals. This, and the fact that some are restricted geographically, is of value when possible cases are being investigated (Table 15.1).

Despite the eradication of smallpox there is still considerable interest in poxviruses. Such interest includes: studies on gene expression including the expression of foreign genes, and in particular gene products which may help the virus to evade the host's defence mechanisms; the use of poxviruses as vaccine vectors; the natural evolution of diseases such as myxomatosis; the maintenance of diseases such as monkeypox, cowpox and possibly buffalo pox in wildlife populations; the possible effects of such viruses on their wildlife reservoirs; evaluation of the importance of human monkeypox; the development of improved vaccines for animal poxvirus infections (Moss, 1996; Baxby, 1998). Although perhaps less important than foot and mouth and rinderpest, diseases of domestic animals such as sheep pox, camel pox and avian pox can cause considerable problems for communities dependent on them (Baxby 1988, 1998).

THE VIRUSES

The poxviruses of vertebrates are separated into eight genera, and species within each genus are very closely related. Some poxviruses have yet to be assigned to genera, and the relationships of some viruses within genera needs further clarification (Esposito *et al.*, 1995; Baxby, 1998).

Genetic hybridization can occur within a genus, and serological relationship between species is very close. Traditionally virus isolates have been identified on the results of biological tests. These methods are still used for presumptive identification, but increasing use is being made of genome analysis. Fortunately the validity of species established on biological criteria has in general been endorsed by genome analysis. The human pathogens are reasonably well-characterized species and are distributed among four genera (Table 15.1) (Esposito *et al.*, 1995).

Structure and Replication

Morphology

In general a poxvirus may be recognized as such by its large size and brick-shaped morphology. Most work has been done on vaccinia, which can be taken as representative of orthopoxviruses, molluscum and tanapox viruses. Virions are 200–250 × 250–300 nm, basically brick-shaped but somewhat pleomorphic; parapoxviruses are slightly smaller

Table 15.1 Poxviruses pathogenic for humans

Genus	Virus	Reservoir host	Animals naturally infected	Geographical distributed	Comment
<i>Orthopoxvirus</i>	Smallpox	Humans	—	Formerly worldwide	Last endemic case 1977 Eradication confirmed 1979
	Monkeypox	Squirrels	Squirrels Monkeys	West and Central Africa	Rare zoonosis. Overall mortality 10%. Limited case-to-case spread
	Cowpox	Rodents	Cats Cattle	Europe, West CIS (USSR)	Rare zoonosis. Contact with cattle unusual
	Vaccinia (buffalopox)	Buffalo? Rodents?	Buffalo	India	Variant of vaccinia. Established in nature
<i>Parapoxvirus</i>	Orf	Sheep	Sheep } Goats } Cattle }	Worldwide	Common trivial zoonoses. Occupational hazards
	Pseudocowpox	Goats Cattle			
<i>Molluscipoxvirus</i>	Molluscum	Humans	—	Worldwide	Trivial infection. Often sexually transmitted
<i>Yatapoxvirus</i>	Tanapox	Monkeys	Monkeys	Kenya, Zaire (Congo Republic)	Rare trivial zoonosis

and somewhat narrower (*c.* 160 nm) (Figure 15.1a, b). Virions released naturally from cells ('extracellular enveloped virus', EEV) have an outer envelope which is soon lost on manipulation and not found on virions released artificially ('intracellular naked virus', INV) (Figures 15.1a,b and 15.2b). The extra envelope has antigens not present in INV, and EEV plays an important role in pathogenesis (Smith *et al.*, 1997). The appearance of both EEV and INV in the electron microscope is affected by stain penetration. The majority of virions have short surface tubules *c.* 10 nm in diameter and are referred to as M ('mulberry' forms) (Figure 15.1b); a minority, slightly larger and electron dense, appear to have a thick (*c.* 20–25 nm) membrane or capsule (hence 'C' forms) (Figure 15.1c). The M form of parapoxvirus is covered by one long tubule which winds round the virion (Figure 15.1a). This gives the characteristic criss-cross effect due to superimposition of the images of the top and bottom surfaces of the virion when seen in the electron microscope. All the forms described (EEV-M, EEV-C, INV-M, INV-C) are infectious.

Thin sections show a central dumbbell-shaped core or nucleoid, flanked by two 'lateral bodies'. Inside the cell, virions are often bounded by double or multiple membranes (Figure 15.2a). When released naturally, the outer membranes fuse with the cell or Golgi membranes and the virion is extruded from the cell, invested by the envelope described above (Figure 15.2b).

Chemical Structure

The genome of poxviruses is one long piece of double-stranded DNA which varies in size from 130 kb (parapoxvirus) to 260 kb (fowlpox virus). The molecule has cross-linked inverted terminal segments and on denaturation forms a closed circle of single-stranded DNA (Moss, 1996). The central portion is highly conserved but differences in the terminal regions of different species provide a means for separating them (Esposito and Knight, 1985). The complete sequences of some strains of vaccinia and smallpox virus and considerable sequences of other poxviruses have been determined, and the location and function of the genes is usually related to the Hind III restriction map of the Copenhagen strain of vaccinia virus (Figure 15.3) (Johnson *et al.*, 1993). The DNA is not infectious *per se*. The virion contains a number of virus-coded enzymes, in particular a DNA-dependent RNA polymerase, which transcribe the viral genome (Moss, 1996).

The virions contain many polypeptides; over 100 have been detected by two-dimensional polyacrylamide electrophoresis, and there is coding potential for *c.* 200. Some are glycosylated and some of these are found in the envelope of EEV (Moss, 1996).

Antigenic Structure

Poxviruses are antigenically complex. Extracts of

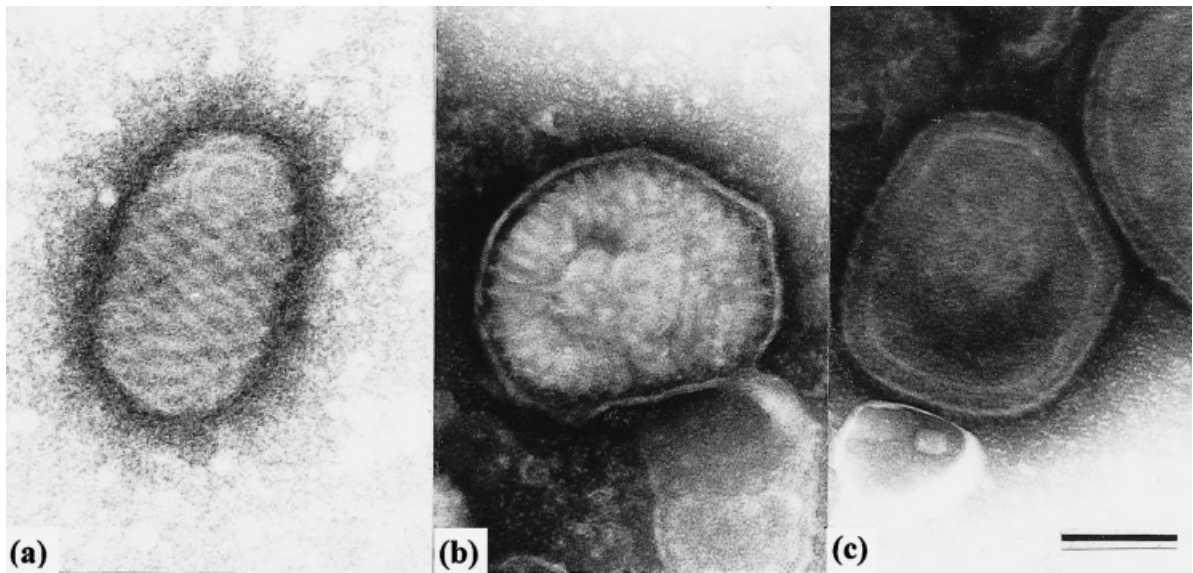

Figure 15.1 (a) Mulberry (M) form of non-enveloped parapox virion; (b) naturally-released (extracellular) M form of *Vaccinia virus*; (c) capsule (C) form of *Vaccinia virus*. (Negative stain; bar = 150 nm)

infected tissue contain a number of precipitating antigens, the precise number of which is unknown. Such extracts will fix complement and react in ELISA and RIA tests, but it is not known how many antigens take part in these reactions. Virus neutralization is a complicated process: analysis with monoclonal antibodies has detected nine neutralizing epitopes distributed among the INV of the different species of orthopoxviruses (Czerny *et al.*, 1994). Extra antigens are present on the outer envelope of EEV, although for technical reasons progress here has been less rapid (Vanderplasschen *et al.*, 1997; Baxby, 1998). Orthopoxviruses produce a haemagglutinin antigen which reacts with erythrocytes from certain fowls. This antigen is present on the envelope of EEV and can also be detected in virus-free supernatants.

Replication and Cultivation

Only the briefest summary can be given here but an authoritative and extensively referenced account has been published recently (Moss, 1996).

Virions are taken into the cell by pinocytosis and/or phagocytosis, and there is increasing evidence that INV and EEV attach to different receptors (Vanderplasschen and Smith, 1997). Constitutive cellular enzymes initiate virus uncoating, but

virion-coded enzymes are essential for the final stages.

Transcription and translation are under close control. Poxvirus genes cannot be controlled by mammalian promoters and there are differences between early and late poxvirus-specific promoters. Some genes, e.g. DNA polymerase, are transcribed from inoculum DNA and switched off by postreplicative gene products. Others, e.g. the haemagglutinin, are produced throughout the replication cycle, but via different promoters. Many gene products are subject to post-transcriptional modification, for example by glycosylation and proteolytic cleavage.

Replication takes place in cytoplasmic factories referred to as B-type inclusions, in which virions at various stages of assembly are seen. Cells infected with some poxviruses (e.g. cowpox, avian poxviruses) also contain electron-dense A-type inclusions, usually containing mature virions; A-type inclusions are easily seen by light microscopy (Figure 15.4).

Molluscum contagiosum virus (MCV) has never been cultivated *in vitro*, although some early antigens and a non-transmissible cytopathic effect may be detected in cell culture (Birchistle and Carrington, 1997). The remaining human pathogens can usually be cultivated in easily obtained cell cultures,

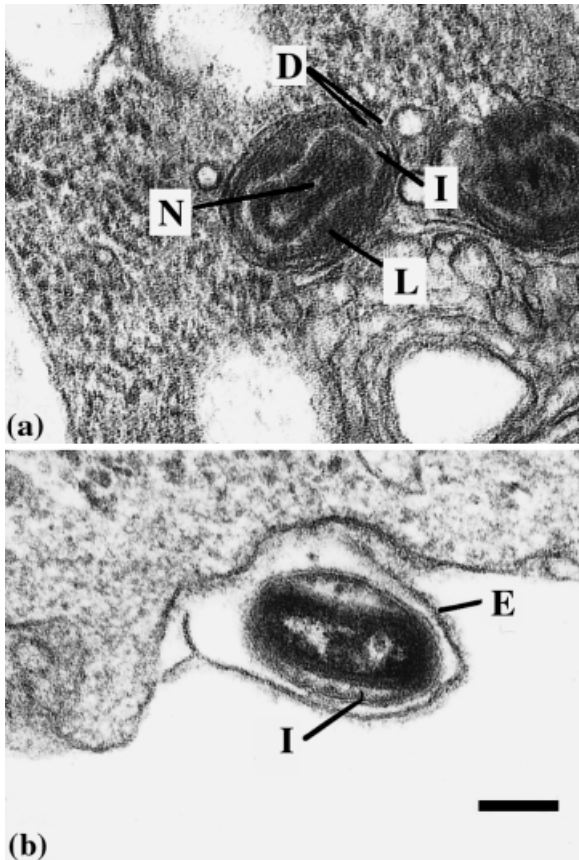

Figure 15.2 Thin sections of *Vaccinia virus*. (a) Virion within cell, invested with double membrane; (b) extracellular virion showing outer envelope, partly detached. D = double membrane; E = outer envelope; I = inner membrane; L = lateral body; N = nucleoid or core. (Bar = 100 nm)

and orthopoxviruses will produce pocks on the chorioallantoic membrane (CAM) of 12-day-old chick embryos. Methods for isolation and identification of individual virus species have recently been reviewed (Eposito and Massung, 1995; Meyer *et al.*, 1997, 1998).

Poxvirus Gene Products and Pathogenesis

There has always been interest in the 'virulence' (i.e. safety) of *Vaccinia virus*, particularly given its close relationship to *Smallpox virus*. Although some empirical studies showed that, for example, TK⁻ mutants were attenuated for some hosts, it was appar-

ent that virulence was a complex multifactorial system. Analysis of the genome has identified genes whose expression is not necessary for replication, and strains which do or do not express some of these genes have been compared *in vivo* and *in vitro*. The nucleotide and amino acid sequences and the observed or predicted properties of these gene products provide evidence for their demonstrated or predicted role in pathogenesis. Some examples are given in Table 15.2, and further details are provided elsewhere (Smith *et al.*, 1997). Gene products identified include some which help the virus to evade the immune system by binding components of, for example, complement (gene C3L), interferon (B8R) or interleukins (B16R), or which inhibit inflammation (B13/14R). Other products determine host range and control apoptosis (gene CHO) or promote cell proliferation (C11L). The febrile response to infection is mediated by interleukin 1 β and is inhibited by a virus-coded gene product (B16R) which binds this cytokine. The dissemination of naturally-released virions (EEV) is an important aspect of pathogenesis and genes have been identified (e.g. B5R) which coded for proteins necessary for the proper development of EEV and expression of virulence.

SMALLPOX

In 1980, the WHO General Assembly accepted the conclusion of an independent commission that smallpox had been eradicated; destruction of the remaining virus stocks, scheduled for 1999, has been delayed. However, the importance of smallpox should not be forgotten. It had a measurable impact on the development of civilization, was the first virus disease for which vaccination and chemoprophylaxis became available, and the first to be eradicated. It is mentioned here only to emphasize the importance of surveillance–containment rather than mass vaccination in the eradication campaign. Authoritative information on all aspects of smallpox is available in the comprehensive and eminently readable account by Fenner *et al.* (1988).

MONKEYPOX

Monkeypox virus was first isolated in 1958 from

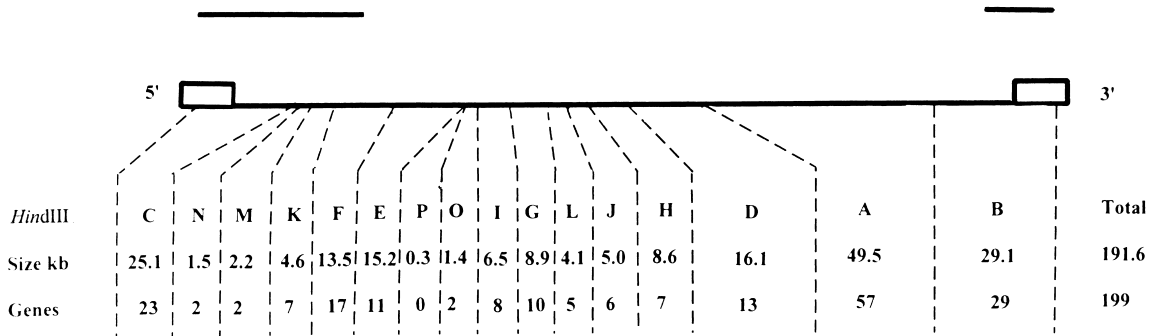

Figure 15.3 Representation of the genome of Copenhagen vaccinia showing *Hind*III restriction fragments labelled A–P according to decreasing size. Inverted terminal repeats (boxes) and two large non-essential regions (horizontal bars) are indicated. (Redrawn from Baxby (1998). Reproduced by permission of Edward Arnold (Publishers) Ltd)

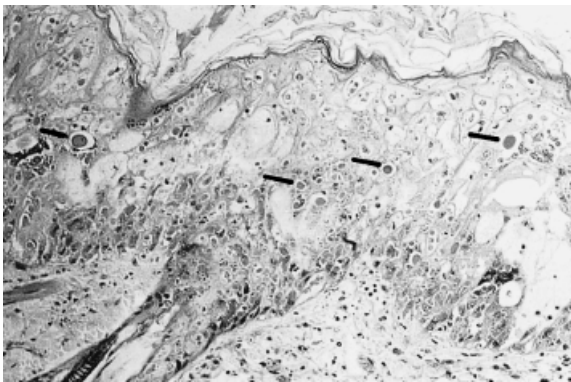

Figure 15.4 Section of cowpox-infected cat skin showing hypertrophy, hyperplasia, leucocyte infiltration and conspicuous intracytoplasmic A-type inclusions (some indicated). (Reproduced from Baxby *et al.* (1994) by permission of Blackwell Science Ltd)

captive Asiatic monkeys. Particular attention was focused on it from 1970 when smallpox surveillance activities in Africa revealed cases of human monkeypox, clinically indistinguishable from smallpox, particularly in Zaire (now Congo Republic). Sporadic outbreaks continue to occur and cause concern (Heyman *et al.*, 1998), but most information is available about cases that occurred prior to 1988.

Pathogenesis

The pathogenesis of human monkeypox is essentially the same as that of smallpox, i.e. an acute febrile exanthem with an incubation period of

about 12 days. During the incubation period virus is distributed initially to internal organs and then to the skin (Fenner *et al.*, 1988; Jezek and Fenner, 1988). The main differences are a greater degree of lymphadenopathy and a lower capacity for case-to-case spread. The major problems concern the source of infection and the mode of transmission.

Table 15.2 Examples of non-essential poxvirus gene products that contribute to 'virulence'

Gene ^a	Product ^b	Comment
C3L	C4b receptor	Binds C4b. Negative mutants attenuated
C11L	EGF	Promotes cell proliferation. Inactivation attenuates
[C22L]	TNF receptor	Binds TNF, contributes to virulence [Disrupted in CopVac]
B5R	EEV antigen	Essential for EEV production
B8R	INF- γ receptor	Bind If- γ . Blocks host defences
[B13/14R]	Serpin	Inhibits inflammation [Non-functional in CopVac]
B16R	IL-1 β	Binds IL-1 β . Inhibits febrile response
[CHO]	Host range	Host range gene in cowpox. Non-expression causes apoptosis in CHO cells

^a With reference to the genome of Copenhagen vaccinia [CopVac]. Initial letter denotes Hind III fragment, number and final letter indicate gene number within fragment and direction of transcription. CHO = Chinese hamster ovary. Bracketed entries = gene non-functional or not present in CopVac (see column 3).

^b C4b = complement component; EGF = epidermal growth factor; TNF = tumour necrosis factor; EEV = extracellular enveloped virus; INF = interferon; Serpin = serine protease inhibitor; IL = interleukin.



Figure 15.5 Human monkeypox on the 8th day of rash. Note the submaxillary and inguinal lymphadenopathy. (Reproduced from Fenner *et al.* (1988) by permission of WHO)

Clinical Features

In general the clinical features are those of a classical or modified case of smallpox. The most obvious difference is the pronounced lymphadenopathy which involves the submandibular, cervical and sublingual regions (Figure 15.5).

Most cases occur in unvaccinated children. In Zaire during 1981–1986 291 cases (86%) occurred in children < 10 years old and only 12 (4%) of these had vaccination scars. The illness lasts 2–4 weeks. Of 292 unvaccinated patients 22 (7.5%) had a mild illness with < 25 skin lesions and were not incapacitated; 55 (19%) had 25–99 lesions, were in-

capable of most physical activity and required nursing; 218 (75%) had > 100 lesions, were totally incapacitated and required intensive nursing. Complications occurred in about 40% of patients: the commonest were bacterial skin infections (16%) and respiratory (12%) and gastrointestinal (5%) disorders. The overall mortality was approximately 10%; however, all the deaths occurred in unvaccinated children, in which group mortality is around 15% (Jezek and Fenner, 1988; Jezek *et al.*, 1988).

Diagnosis

Human monkeypox has not been detected outside West Africa. Clinical diagnosis may present a problem because fewer physicians now have experience with smallpox, which human monkeypox closely resembles. Access to a virus diagnostic laboratory should permit detection of virus by electron microscopy and this provides a sensitive presumptive diagnosis. In some circumstances it may be important to distinguish between monkeypox and tanapox (see below). In the past it was essential to differentiate between *Monkeypox* and *Smallpox viruses*, which could be done by examination of pocks produced on the CAM at 39°C, a temperature which inhibits smallpox, or by using cell cultures (e.g. RK13) in which *Monkeypox virus* grows well and *Smallpox virus* poorly, if at all.

Methods are being developed to detect orthopoxvirus species-specific genome sequences which will permit recognition of individual viruses where necessary (Meyer *et al.*, 1997, 1998). At the same time detailed analysis of monkeypox DNA has detected minor differences among different strains which may be of value in epidemiological investigations (Douglas *et al.*, 1994). The close serological relationships among orthopoxviruses makes detection of monkeypox-specific antigens difficult but methods are available and being refined which are of value, particularly for epidemiological studies of monkeypox virus in its natural reservoirs (Khodakevich *et al.*, 1988).

Of human cases in the 1981–1986 Zaire survey, 74% were confirmed by detection of virus by electron microscopy and virus isolation, and in another 22% retrospectively by serology.

Epidemiology and Control

Management of individual cases will be supportive, with case-to-case spread reduced by isolation and, if available, the use of smallpox vaccine for contacts.

A Misnamed African Disease of Squirrels

Monkeypox virus was so named because it was first detected in captive Asiatic monkeys. However the virus has only been found naturally in Africa and evidence points to squirrels (*Funisciurus* spp., *Heliosciurus* spp.) as important reservoir hosts. Surveys in Zaire detected monkeypox-specific antibodies in 85 of 347 (25%) squirrels sampled but from none of 233 terrestrial rodents. Monkeypox-specific antibody has been detected in very few monkeys, which, like humans are probably only occasional hosts (Khodakevich *et al.*, 1988).

Control

Human cases occur in villages in the rain forests where a variety of animals are captured for food. Infection of children might be explained by their playing with carcasses. The results of the comprehensive surveys carried out in the 1980s indicated that those infected were principally unvaccinated children and that case-to-case spread was unusual. Control measures are based in interposing a buffer zone of cleared land between the arboreal reservoir and cultivated land, the development of animal husbandry as a source of meat, and on education in the handling of wildlife, with emphasis on any trapping done by those previously vaccinated; continued vaccination was not thought necessary (Khodakevich *et al.*, 1988).

Only occasional human cases were reported thereafter but there was a resurgence in 1996–1997 which has not yet been fully explained. Increased political unrest would lead to population displacement and breakdown of routine control measures, and the levels of vaccine-induced immunity will decline with time. A potentially serious finding which requires clarification is the observation that case-to-case transmission occurred more frequently during 1996–1997 than earlier (Heymann *et al.*, 1998). Comparison of the genomes of smallpox virus and monkeypox virus strains isolated up to 1986 suggested they have evolved separately

(Douglas and Dumbell, 1992) and the results of studies on strains isolated during 1996–1997 are awaited with interest.

Laboratory workers studying *Monkeypox virus* should be vaccinated with vaccinia and handle the virus in safety cabinets. However, the risk of infection other than by accidental inoculation is probably very low.

VACCINIA

Vaccination

Smallpox vaccination, although an efficient prophylactic against smallpox, was not without well-documented risks. These ranged from rare but severe complications, such as generalized vaccinia which occurred in about 200 per million primary vaccinees, to relatively mild but still troublesome satellite lesions or nondescript rashes which occurred in about 8% of vaccinees (Baxby, 1993). Routine use of vaccine, except perhaps for certain military personnel, is now discontinued. It is necessary for those working with *Monkeypox virus*, but policies about its use for those working with *Cowpox virus* vary (Baxby, 1993).

Buffalopox

Attention has been drawn to 'buffalopox' in buffaloes and their handlers, particularly in India. Some outbreaks have certainly been caused by typical strains of *Vaccinia virus*. However studies on isolates obtained after the cessation of routine vaccination suggest that cases continue to be caused by a virus different from vaccinia ((Dumbell and Richardson, 1993). These isolates, unlike vaccinia, do not produce pocks on the CAM above 39°C. Their DNA is sufficiently-similar to that of vaccinia virus to regard them as variants or subspecies of it (Dumbell and Richardson, 1993; Esposito *et al.*, 1995). However, at present it is not known whether buffaloes are the reservoir host or whether wildlife reservoirs are involved as in the case of cowpox (see below).

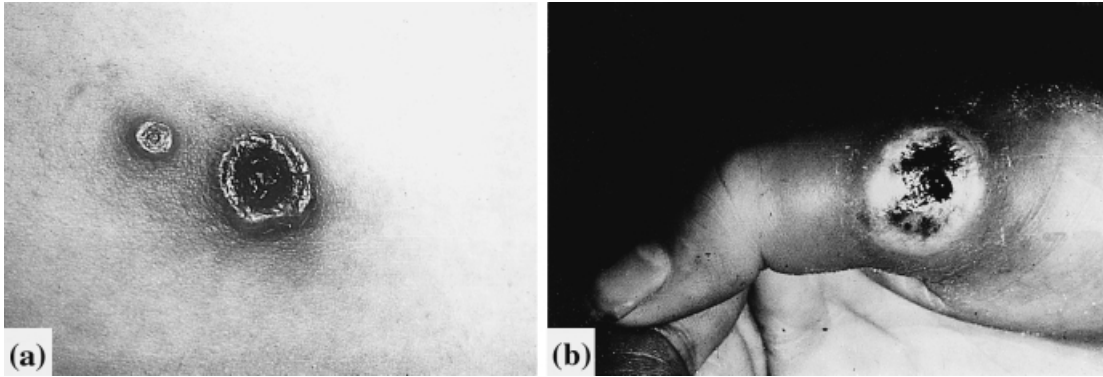

Figure 15.6 Human cowpox. (a) Primary and secondary lesions; the former at the early eschar stage, the latter at the early vesicular stage; (b) at the late vesicular–early pustular stage showing a haemorrhagic lesion with marked oedema and erythema. (a) Reproduced from Baxby *et al.* (1994) by permission of Blackwell Science Ltd. (b) From Baxby, D. (1982) The natural history of cowpox. *Bristol Medico-Chirurgical Journal*, **97**, 12; reproduced by permission of the Editor

Recombinant Poxvirus Vaccines

‘Foreign’ genes have been inserted into poxviruses, particularly vaccinia. The resultant recombinant strains retain their infectivity and, in general, the inserted genes are expressed properly. Thus, the use of such recombinants as vaccines has been advocated. Most work has been done on vaccinia as a vector, and vaccinia recombinant vaccines have been used to control wildlife rabies in Europe (Pastoret and Brochier, 1996). However, there is still concern about the use of vaccinia virus as a vector, despite the development of attenuated strains (Smith *et al.*, 1997). Other poxviruses are being considered as vaccine vectors; in particular the use of avian poxviruses as vectors for mammalian vaccines. These are of interest because avian poxviruses induce a good immune response to the foreign gene product without initiating productive infection in mammals (Limbach and Paoletti, 1996).

COWPOX

Cowpox is a relatively unimportant zoonosis, of interest principally because of recent re-evaluation of its epidemiology. Despite its name, *Cowpox virus* is not enzootic in cattle. The virus is maintained in a variety of European rodents, and the most commonly reported victim is the domestic cat, from which source human infections are acquired (Baxby and Bennett, 1997b).

Pathogenesis

Most information is available about cowpox in the domestic cat, an accidental host in which a relatively mild generalized disease occurs following primary infection via a bite or scratch (Bennett *et al.*, 1990).

Human infection, similarly acquired, usually remains localized and is characterized by a marked inflammatory and erythematous response (Baxby *et al.*, 1994). The bulk of the lesion is caused by hypertrophy and proliferation of the basal cell layer of the epidermis, together with massive inflammatory infiltration. Infection usually spreads into follicles and typical A-type inclusions are usually seen (Figure 15.4). By analogy with smallpox vaccination a transient viraemia might be expected.

Clinical Features

Most information is available from a detailed analysis of 54 human cases investigated during 1969–1993 (Baxby *et al.*, 1994). Lesions are generally restricted to the hands and face and most patients (72%) have only one lesion. Multiple lesions may be caused by multiple primary inoculations, autoinoculation, and very occasionally by lymphatic or viraemic spread. Occasionally a very severe infection, and death, may occur usually in immunosuppressed individuals.

The lesion passes through macular, papular, vesicular and pustular stages before forming a hard

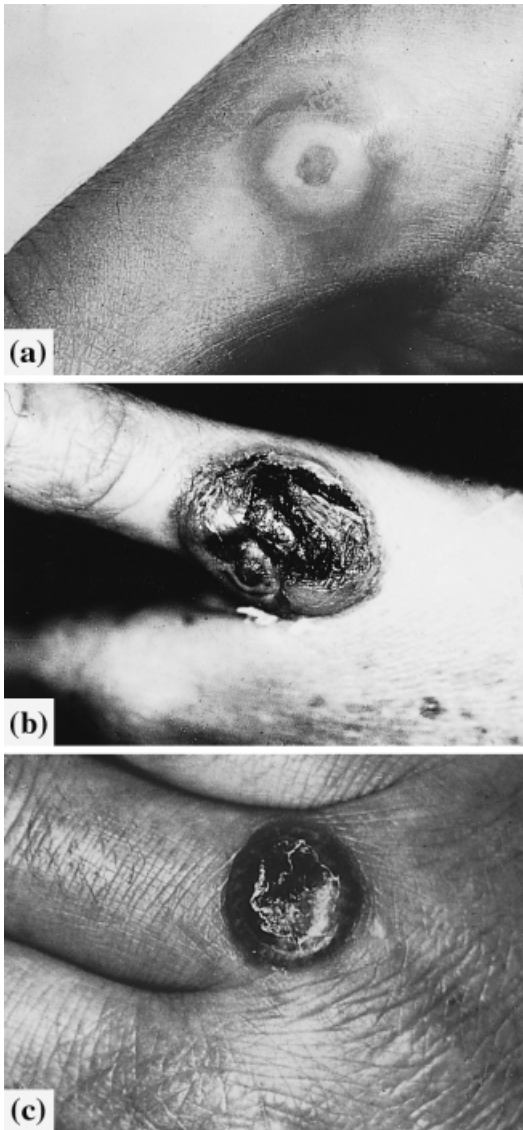

Figure 15.7 Parapoxvirus infection showing lesions in different patients. (a) At the 'target' stage; (b) an ulcerated granulomatous lesion which could be misdiagnosed as a malignancy; (c) crusting lesion. ((a) From Baxby, D. (1982) *The natural history of cowpox. Bristol Medico-Chirurgical Journal*, 97, 12; reproduced by permission of the Editor. (b) Kindly supplied by Dr M.S. Lewis-Jones. (c) Reproduced from Baxby, D. *et al.* (1994) by permission of Blackwell Science Ltd)

black crust (Figure 15.6a). The lesion is usually very painful and erythema and oedema are common at the late vesicular and pustular stages (Figure 15.6b). There is usually lymphadenitis, fever and general malaise, often referred to as 'flu-like'. These features

are usually severe in children, and absence from school or work is common; 16 of 54 patients (30%) were hospitalized. Most cases take 6–8 weeks to recover; in some cases it may take > 12 weeks. Scarring is usually permanent.

Diagnosis

Clinical

The main drawback to clinical diagnosis of cowpox is its rarity and the failure to appreciate important epidemiological information (see below). Cowpox, which is restricted geographically (Table 15.1), should be considered in anyone, including young children, presenting with a painful haemorrhagic lesion or black eschar; with or without erythema and oedema; accompanied by lymphadenopathy and a systemic 'flu-like' illness. This applies particularly to patients seen in July–October and/or who have had contact with cats (see below). Attempts to establish contact with cattle are usually counter-productive. Differential diagnoses include parapoxvirus (see below), herpes and anthrax. Colour illustrations of all these lesions are available (Baxby *et al.*, 1994), which, together with a properly taken history, should help clinical diagnosis. Unfortunately the rarity of human cowpox means that general practitioners or even consultants seldom have an opportunity to investigate a second case.

Laboratory

Electron microscopy of vesicle fluid or extracts of crusts is particularly valuable because it will differentiate between parapox, herpes and presumptive cowpox infections. Of 24 cases of cowpox where adequate material was available, electron microscopy was successful in 23.

If necessary, virus may be isolated on the CAM, where the production of intensely haemorrhagic pocks is diagnostic. Cytopathic effect occurs in many cell lines (Vero, MRC-5, RK13) and detection of A-type inclusions is diagnostic, as it would be if found in biopsy material. Not all strains of cowpox are identical and genome analysis may show differences of epidemiological value.

Epidemiology

As indicated above, cowpox is maintained in rodents; in Britain these are bank voles and woodmice (Crouch *et al.*, 1995; Baxby and Bennett, 1997b). The domestic cat is the most common source of human infection and this probably explains the occurrence of cases in children; 26% of 54 cases were in children < 12 years. Most feline and human cases occur between July and October, with only occasional cases between January and June. Human cases occur in which no source is traced, but despite detailed enquiries only three human cases in Britain since 1968 have been traced to a bovine source, and no case of bovine cowpox has been detected since 1976.

Cowpox virus has a wide host range, and an interesting finding has been the occurrence of cowpox in a variety of captive exotic species in European zoos. Victims have included cheetahs, lions, anteaters, rhinoceros, elephants and okapi, and infection has occasionally been transmitted to animal handlers (Pilaski and Rosen-Wolff, 1988; Baxby and Bennett, 1997b).

Control

Much evidence, albeit circumstantial, suggests that *Cowpox virus* is of low infectivity for humans (Baxby and Bennett, 1997b). Careful handling of infected cats prevents cat-to-human transmission and no case has occurred in a handler after diagnosis of the feline case. Person-to-person transmission has not been reported. Management is supportive, with antibiotics to control any bacterial superinfection. Serious infections could be treated with antivaccinia γ -globulin if available. Acyclovir has no activity against poxviruses. Corticosteroids are contraindicated: when used they have exacerbated infection and delayed recovery.

PARAPOXVIRUS

Parapoxvirus infections are widespread in sheep, goats and cattle. Human infections from these sources are a common occupational hazard for those in contact with infected animals.

Parapoxvirus infection in sheep and goats is

usually referred to as contagious pustular dermatitis or orf, and the corresponding human infection as orf. Parapoxvirus infection of cattle is usually referred to as paravaccinia, pseudocowpox or ring sores, and the human equivalent as paravaccinia, pseudocowpox or milker's nodes.

Pathogenesis

Infection occurs via cuts and scratches and usually remains localized. Lesions are produced by hypertrophy and proliferation of epidermal cells, often marked, and leucocyte infiltration. Histological examination shows many small multilocular vesicles within the dermis; true macrovesicles rarely occur (Johannesson *et al.*, 1975; Yirrell and Vestey, 1994). Lymphadenopathy, malaise and generalized lesions are relatively uncommon and the immune response is poor (Leavell *et al.*, 1968; Yirrell *et al.*, 1994).

Clinical Features

The progressive stages of human infection have been described in detail (Leavell *et al.*, 1968; Johannesson *et al.*, 1975; Yirrell and Vestey, 1994), and colour illustrations provided (Baxby *et al.*, 1994). Lesions start as erythematous papules and progress to a 'target' stage (Figure 15.7a). This, seen 1–2 weeks after infection, has a red centre surrounded by a white halo and an outer inflamed halo. This progresses to a nodular then papillomatous stage, which often has a 'weeping' surface. In some patients this may enlarge and persist for some weeks before resolving (Figure 15.7b), and may cause some concern (see Diagnosis, below). The lesion resolves via a crusting stage (Figure 15.7c), which may last some weeks (Johannesson *et al.*, 1975; Yirrell and Vestey, 1994). Occasionally very large granulomatous lesions occur which may need surgical removal (Pether *et al.*, 1986).

Most patients have only one lesion, but multiple primary lesions may occur. Systemic reaction is relatively uncommon and the lesion is often not particularly painful. Attention has been drawn to erythema multiforme as a common complication of orf but, because most ordinary cases go unreported, the actual incidence of erythema is probably low.

The immune response in natural human infection has been investigated (Yirrel *et al.*, 1994). There is a vigorous but short-lived cell-mediated response, and a relatively poor and short-lived humoral response. This is consistent with the occurrence of second attacks in 8–12% of individuals (Robinson and Peterson, 1983; Yirrel and Vestey, 1994).

Diagnosis

Clinical

The viruses which cause orf and paravaccinia are closely related (Esposito *et al.*, 1995; Mercer *et al.*, 1997), and in the UK human cases are reported as 'orf/paravaccinia', whatever the animal source (Baxby and Bennett, 1997a). Clinical diagnosis of uncomplicated cases in patients with a known animal contact should not cause difficulties. However, farmworkers, etc. recognize the infection and tend not to seek medical attention for routine cases. Consequently a disproportionately large number of reported cases have no known contact with infected animals. Of approximately 500 cases surveyed during 1978–1995, some 45% had no such contact. Clinical diagnosis of such cases, particularly if severe or prolonged, may cause difficulties. In particular, large weeping granulomatous or papillomatous lesions may be misdiagnosed as malignancies, resulting in one case in unnecessary amputation (Johanneson *et al.*, 1975).

Laboratory

Virions with the characteristic morphology of paravaccinaviruses are usually easily seen in lesion extracts, and this provides a rapid, certain diagnosis. The virus can be grown in cell culture but this is not attempted routinely.

Epidemiology

Human infection is an occupational hazard of farmworkers, abattoir workers, veterinary surgeons and students, etc. It is most common in the lambing and calving seasons, and more commonly reported in sheepworkers than cattlemen; this probably reflects differences in animal husbandry. Of 191 cases with a known source surveyed during 1978–1995,

84% had an ovine source and 16% were from cattle. During the same period 32 cases occurred in abattoir workers (Baxby and Bennett, 1997a).

Control

Most workers at risk get infected at some stage and reinfection is not uncommon. The impact of human infection in the farming and meat industries occasionally causes concern, and has led to industrial disputes (Johanneson *et al.*, 1975; Robinson and Peterson, 1983). Individuals should take care not to spread infection by autoinoculation or to contacts, including animals. The vaccine used to control orf in sheep is fully virulent and has caused human infection.

MOLLUSCUM CONTAGIOSUM

Although lesions resembling molluscum and containing poxvirions have been detected in, for example, horses, human molluscum contagiosum is regarded as a specifically human infection and there is no evidence of transmission between humans and other animals. Molluscum is a benign skin tumour which occurs worldwide. It has been the subject of a comprehensive recent review which, although not illustrated, is extensively referenced (Birthistle and Carrington, 1997).

Pathogenesis

After a variable, sometimes lengthy, incubation period, papules develop, formed by epidermal hypertrophy. This produces a nodule and also extends the dermis downwards, but the basement membrane usually remains intact. Characteristic inclusions (Henderson–Patterson bodies) are formed in the prickle cell layer and gradually enlarge as the cells age and migrate to the surface. These cells are replaced by hyperplasia of the basal cell layer. The inclusion is a well-defined sac packed with virions (Shelly and Burmeister, 1986). The lesion is circumscribed by a connective tissue capsule and the dermis, apart from distortion, remains essentially normal. Occasionally an inflammatory infiltration of the dermis may occur (Brown *et al.*, 1981).



Figure 15.8 Molluscum contagiosum lesions showing umbilication. (From a transparency kindly supplied by Dr J. Verbov)

Clinical Features

Infection is via trauma to the skin. The characteristic lesion begins as a small papule and, when mature, is a discrete, waxy, smooth, dome-shaped pearly or flesh-coloured nodule, often umbilicated (Figure 15.8). There are usually 1–20 lesions but occasionally there may be hundreds. They may become confluent along the line of a scratch and satellite lesions are occasionally seen.

In children, lesions occur mainly on the trunk and proximal extremities. In adults they tend to occur on the trunk, pubic area and thighs, but in all cases infection may be transmitted to other parts by autoinoculation (Brown *et al.*, 1981). Individual lesions last for about 2 months but the disease usually lasts 6–9 months (Steffan and Markman, 1989). More severe and prolonged infection tends to occur in individuals with impaired cell-mediated immunity, including human immunodeficiency virus (HIV) infection (Birthistle and Carrington, 1997).

Diagnosis

The appearance of lesions in normal cases is generally sufficiently characteristic to permit clinical diagnosis. Virions can usually be seen in large numbers if material expressed from the lesion is examined by electron microscopy. The lack of a marked inflammatory response and failure to isolate an agent in cell culture or CAM should eliminate other poxvirus infections.

Epidemiology

Restriction endonuclease analysis of molluscum virus DNA has detected three main subtypes. Their incidence varies from 80 to 90% for MCV-I to c. 1% for MCV-III but all subtypes cause similar lesions and infect the same anatomical sites (Scholz *et al.*, 1989; Porter *et al.*, 1992).

The virus occurs worldwide and tends to be more common in socially deprived areas. Traditional modes of transmission are associated with mild skin trauma such as contact sports and shared towels; however, there is increasing evidence that the disease is sexually transmitted and that genital lesions are more common (Birthistle and Carrington, 1997).

Control

Infection is benign and recovery usually spontaneous, but treatment may be sought for cosmetic reasons, particularly for facial or multiple lesions. Various treatments have been tried (Birthistle and Carrington, 1997). Chemical treatments include phenolics, silver nitrate, trichloroacetic and glacial acetic acid. Physical methods include curettage and cryotherapy. Mild trauma may induce a cure, which may be due to release of virus-infected cells accessible to the immune system.

Prevention in developed countries is based on attention to personal hygiene, and in developing countries to this and to general improvements in living conditions. Although relatively unimportant *per se*, the possibility that molluscum may act as a marker for more serious conditions has been raised (Oriel, 1987).

TANAPOX

Human infection with *Tanapox virus* was first recognized in the Lake Tana area of Kenya in 1957, and particular attention was paid to it during posteradication smallpox surveillance. An account of 264 laboratory-confirmed cases from Zaire (Congo Republic), with colour illustrations, is available (Jezek *et al.*, 1985), as is information on the virus itself (Knight *et al.*, 1989).

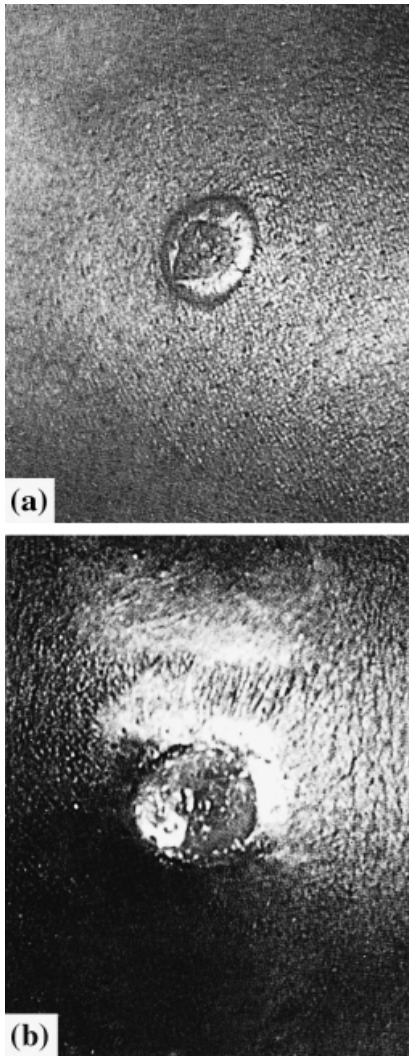

Figure 15.9 Human tanapox lesions. (a) After 10 days, showing oedema and umbilication; (b) after 26 days, showing ulcer formation. (Reproduced from Jezek *et al.* (1985) by permission of WHO)

Pathogenesis and Clinical Features

Infection is via the skin. The lesion is characterized by pronounced epidermal hyperplasia with little involvement of the dermis. There is a short prodromal illness with fever and malaise. The lesion starts as a macule and progresses to a raised nodule, which becomes umbilicated (Figure 15.9). The lesions are relatively large (> 10 mm) and usually break down to form ulcers (Figure 15.9b). There is

usually erythema and oedema and lymphadenopathy is common. The lesions generally disappear within 6 weeks. Most (78%) patients have only one lesion, and very few have more than two. They may occur on any exposed area but the head tends to be spared.

Diagnosis

In considering a diagnosis of tanapox the limited geographical distribution should be considered. The solid nodular/ulcerated lesions are larger and develop more slowly than those of monkeypox, but are smaller and develop more rapidly than those of tropical ulcers.

Virus can be detected by electron microscopy but this would not exclude morphologically similar viruses; serological tests on lesion extract would do this. Tanapox virus grows well in a number of cell lines (e.g. Vero, MRC-5, BSC-1) but not on CAM.

Epidemiology and Control

The virus has a simian reservoir and is restricted to Africa, principally Kenya and Zaire (Congo Republic). Human-to-human transmission does not occur naturally, and it is thought that transmission from monkeys occurs mainly due to overcrowding during flooding, unrest, etc. In general, measures for the prevention of monkeypox would be applicable to tanapox; however, the mild and sporadic nature of the infection probably means that specific measures are unnecessary.

DIAGNOSIS

When considering a diagnosis of poxvirus infection the restricted geographical distribution and potential animal source are important features to consider. In many cases the differential diagnosis is between a particular poxvirus infection and other infections, e.g. herpes, tropical ulcers, anthrax, bacterial abscess, etc., rather than between two different poxviruses.

Electron microscopy is important in rapid diagnosis and will confirm parapox infection or exclude pox infection altogether if herpes virus is seen. Fur-

ther information, if required, can be obtained by virus isolation in cell culture and/or CAM, often making use of efficiency of growth at elevated temperatures. Virus-specific antigens may be detected by a variety of techniques, and tests for virus-specific gene products by polymerase chain reaction (PCR) are also being used (Meyer *et al.*, 1997, 1998).

Poxviruses will remain infective at ambient temperatures, particularly if kept dry. If specimens cannot be tested 'on the spot', infectivity is retained during transport by first-class mail without the need for special transport medium. Vesicle fluid should be smeared on a slide and air-dried. On receipt the material can be reconstituted in buffer. Scapings from molluscum and parapox lesions can be treated similarly. The infectivity of virus in dried crusts is retained for long periods. Virus may be extracted from such material by freeze-thawing and ultrasonic treatment. However, if the differential diagnosis includes pathogens less resistant than poxviruses, greater care should be taken and appropriate-transport medium, etc. used.

REFERENCES

- Baxby, D. (1988) Poxvirus infections in domestic animals. In *Diseases in Laboratory and Captive Animals* (ed. G. Darai), pp 17–35. Nijhoff, Boston.
- Baxby, D. (1993) Indications for smallpox vaccination: policies still differ. *Vaccine*, **11**, 395–399.
- Baxby, D. (1998) Poxviruses. In *Topley and Wilson's Microbiology and Microbial Infections*, vol. 1 (eds L.H. Collier, A. Balows and M. Sussman), pp 367–383. Edward Arnold, London.
- Baxby, D. and Bennett, M. (1997a) Poxvirus zoonoses. *Journal of Medical Microbiology*, **46**, 17–20.
- Baxby, D. and Bennett, M. (1997b) Cowpox: a re-evaluation of the risks of human infection based on new epidemiological information. *Archives of Virology. Supplementum*, **13**, 1–12.
- Baxby, D., Bennett, M. and Getty, B. (1994) Human cowpox 1969–93; a review based on 54 cases. *British Journal of Dermatology*, **131**, 598–607.
- Bennett, M., Gaskell, C.J., Baxby, D. *et al.* (1990) Feline cowpox infection. *Journal of Small Animal Practice*, **31**, 167–173.
- Birthistle, K. and Carrington, D. (1997) Molluscum contagiosum virus. *Journal of Infection*, **34**, 21–28.
- Brown, S.T., Nalley, J.F. and Kraus, S.J. (1981) Molluscum contagiosum. *Sexually Transmitted Diseases*, **8**, 227–234.
- Crouch, A.C., Baxby, D., McCracken, C.M. *et al.* (1995) Serological evidence for the reservoir hosts of cowpox virus in British wildlife. *Epidemiology and Infection*, **115**, 185–191.
- Czerny, C.-P., Johann, S., Hölzle, L. *et al.* (1994) Epitope detection in the envelope of intracellular mature orthopox viruses and identification of encoding genes. *Virology*, **200**, 764–777.
- Douglas, N.J. and Dumbell, K.R. (1992) Independent evolution of monkeypox and variola viruses. *Journal of Virology*, **66**, 7565–7567.
- Douglas, N.J., Richardson, M. and Dumbell, K.R. (1994) Evidence for recent genetic variation in monkeypox viruses. *Journal of General Virology*, **75**, 1303–1309.
- Dumbell, K.R. and Richardson, M. (1993) Virological investigations of specimens from buffaloes affected by buffalopox in Maharashtra State, India, between 1985 and 1987. *Archives of Virology*, **128**, 257–267.
- Esposito, J.J. and Knight, J.C. (1985) Orthopoxvirus DNA: a comparison of restriction profiles and maps. *Virology*, **135**, 230–251.
- Esposito, J.J. and Massung, R.F. (1995) Poxvirus infections in humans. In *Manual of Clinical Microbiology*, 6th ed. (eds P.R. Murray, F. Tenover, E.J. Baron, *et al.*), pp 1131–1138. American Society for Microbiology, Washington DC.
- Esposito, J.J., Baxby, D., Black, D. *et al.* (1995) Poxviridae. In *Viral Taxonomy* (eds F.A. Murphy, C.M. Fauquet, D.H.L. Bishop *et al.*), pp 79–91. Springer-Verlag, New York.
- Fenner, F., Henderson, D.A., Arita, I. *et al.* (1988) *Smallpox and its Eradication*. World Health Organization, Geneva.
- Heymann, D.L., Szczeniowski, M. and Esteves, K. (1998) Re-emergence of monkeypox in Africa: a review of the past six years. *British Medical Bulletin*, **54**, 693–702.
- Jezek, Z. and Fenner, F. (1988) Human monkeypox. *Monographs in Virology*, vol. 17. Karger, Basel.
- Jezek, Z., Arita, I., Szczeniowski, M. *et al.* (1985) Human tanapox in Zaire: clinical and epidemiological observations on cases confirmed by laboratory studies. *Bulletin of the World Health Organization*, **63**, 1027–1035.
- Jezek, Z., Grab, B., Szczeniowski, M. *et al.* (1988) Human monkeypox: secondary attack rates. *Bulletin of the World Health Organization*, **66**, 465–470.
- Johannesson, J.V., Krogh, H.K., Solberg, I. *et al.* (1975) Human orf. *Journal of Cutaneous Pathology*, **2**, 265–283.
- Johnson, G.P., Goebel, S.J. and Paoletti, E. (1993) An update on the vaccinia virus genome. *Virology*, **196**, 381–401.
- Khodacevich, L., Jezek, Z. and Messinger, D. (1988) Monkeypox virus: ecology and public health significance. *Bulletin of the World Health Organization*, **66**, 747–752.
- Knight, J.C., Novembre, F.J., Brown, D.R. *et al.* (1989) Studies on tanapox virus. *Virology*, **172**, 116–124.
- Leavell, U.W., McNamara, M.J., Muelling, R. *et al.* (1968) Orf: report of 19 human cases with clinical and pathological observations. *Journal of the American Medical Association*, **204**, 657–664.
- Limbach, P. and Paoletti, E. (1996) Non replicating expression vectors: application in vaccine development and gene therapy. *Epidemiology and Infection*, **116**, 241–246.
- Mercer, A., Fleming, S., Robinson, A. *et al.* (1997) Molecular genetics analyses of parapoxviruses pathogenic for humans. *Archives of Virology. Supplementum*, **13**, 25–34.
- Meyer, H., Ropp, S.L. and Esposito, J.J. (1997) Gene for A-type inclusion body protein is useful for a polymerase chain reaction assay to differentiate orthopoxviruses. *Journal of Virological Methods*, **64**, 217–22.
- Meyer, H., Ropp, S.L. and Esposito, J.J. (1998) Poxviruses. In *Methods in Molecular Biology: Diagnostic Virology Protocols* (eds A. Warnes and J. Stephenson), pp 199–211. Humana Press, Totowa NJ.
- Moss, B. (1996) *Poxviridae: the viruses and their replication*. In

- Fundamental Virology* (eds B.N. Fields, D.M. Knipe, P.M. Howley *et al.*), 1163–1197. Lippincott-Raven, Philadelphia.
- Oriel, J.D. (1987) The increase in molluscum contagiosum. *British Medical Journal*, **294**, 74.
- Pastoret, P.P. and Brochier, B. (1996) The development and use of a vaccinia recombinant oral vaccine for the control of wildlife rabies. *Epidemiology and Infection*, **116**, 235–240.
- Pether, J.V.S., Guerrier, C.J.W., Jones, S.M. *et al.* (1986) Giant orf in a normal individual. *British Journal of Dermatology*, **115**, 497–499.
- Pilaski, J. and Rösen-Wolff, A. (1988) Poxvirus infection in zoo-kept mammals. In *Virus Diseases in Laboratory and Captive Animals* (ed. G. Darai), pp 84–100. Nijhoff, Boston.
- Porter, C.D., Blake, N.W., Cream, J.J. *et al.* (1992) Molluscum contagiosum virus. In *Molecular and Cell Biology of Sexually Transmitted Diseases* (eds D. Wright and L. Archard), pp 233–257. Chapman and Hall, London.
- Robinson, A.J. and Petersen, G.V. (1983) Orf virus infection of workers in the meat industry. *New Zealand Medical Journal*, **96**, 81–85.
- Scholtz, J., Rosen-Wolff, A., Bugert, J. *et al.* (1989) Epidemiology of molluscum contagiosum using genetic analysis of the viral DNA. *Journal of Medical Virology*, **27**, 87–90.
- Shelly, W.B. and Burmeister, V. (1986) Demonstration of a unique viral structure: the molluscum viral colony sac. *British Journal of Dermatology*, **115**, 557–562.
- Smith, G.L., Symons, J.A., Khanna, A. *et al.* (1997) Vaccinia virus immune evasion. *Immunological Reviews*, **159**, 137–154.
- Steffen, C. and Markman, J. (1989) Spontaneous disappearance of molluscum contagiosum. *Archives of Dermatology*, **116**, 923–924.
- Vanderplasschen, A. and Smith, G.L. (1997) A novel binding assay using confocal microscopy: demonstration that the intracellular vaccinia virions bind to different cellular receptors. *Journal of Virology*, **71**, 4032–4041.
- Vanderplasschen, A., Hollinshead, M. and Smith, G.L. (1997) Antibodies against vaccinia virus do not neutralize extracellular enveloped virus but prevent release from infected cells and comet formation. *Journal of General Virology*, **78**, 2041–2048.
- Yirrell, D.L. and Vestey, J.P. (1994) Human orf infections. *Journal of the European Academy of Dermatology and Venereology*, **3**, 451–459.
- Yirrell, D.L., Vestey, J.P. and Norval, M. (1994) Immune responses of patients to orf virus infection. *British Journal of Dermatology*, **130**, 438–443.

Alphaviruses

Nicola S. Brink

Royal Free and University College Medical School, London, UK

and

Graham Lloyd

Centre for Applied Microbiology and Research, Porton Down, UK

INTRODUCTION

In 1967 the World Health Organization (WHO, 1967) defined arboviruses as:

viruses which are maintained in nature principally, or to an important extent, through biological transmission between susceptible vertebrate hosts by haematophagous arthropods: they multiply and produce viraemia in the vertebrates, multiply in the tissues of arthropods, and are passed on to new vertebrates by the bites of arthropods after a period of extrinsic incubation.

The definition was therefore based on biological considerations. The arboviruses were initially divided into group A (later known as alphaviruses) and group B (later known as flaviviruses), but this was followed by the recognition of further antigenically related groups of arboviruses. Alphaviruses and flaviviruses were later included as two separate genera in the family *Togaviridae*. More recently, however, flaviviruses have been classified as a separate family, the *Flaviviridae*.

All medically important vector-borne togaviruses are members of the genus *Alphavirus*. Alphaviruses are transmitted to their vertebrate hosts by mosquitoes. Natural vertebrate hosts include birds and rodents. Infection in the vertebrate is usually inapparent, but can, under certain circumstances,

cause disease and death. Transmission may also occur to domestic animals and humans. Here again the spectrum of disease varies from a clinically inapparent infection to a severe disease and even death.

More recently attention has focused on the use of alphaviruses as expression vectors. It has been suggested that alphaviruses may be useful as vectors for recombinant vaccines where transient and high levels of protein expression are required. Studies have shown that recombinant alphavirus vaccines can induce both humoral and cellular immune responses with good protective effects (Tubulekas *et al.*, 1997). Further work in this field is clearly needed.

MORPHOLOGY

The alphaviruses are essentially spherical, 50–70 nm in diameter (Figure 16.1) and consist of three components: an outer glycoprotein shell, a lipid bilayer and an RNA-containing core or nucleocapsid (Peters and Dalrymple, 1990). The lipid bilayer is derived from the host-cell plasma membrane. The viral encoded glycoproteins, designated E1 and E2, form the outer surface of the virus and interact with cellular receptors and host derived antibodies. The glycoproteins are arranged in an icosahedral surface lattice (Harrison, 1986).

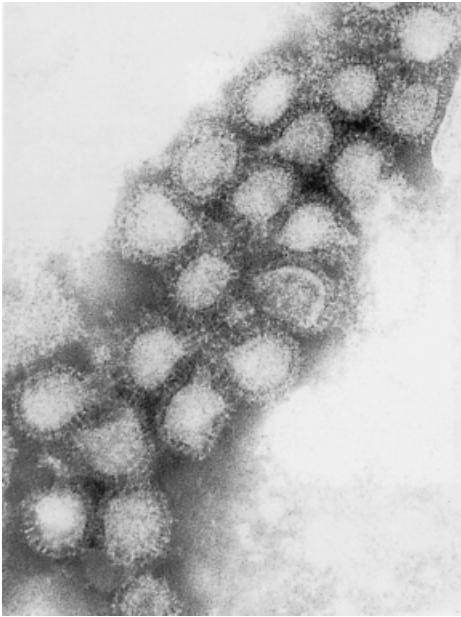

Figure 16.1 Electron micrograph of a preparation of Sindbis virus. (3% potassium phosphotungstate pH 7.0, Final magnification $\times 200\,000$). (Micrograph courtesy of Professor C.R. Madeley, The Royal Victoria Infirmary, Newcastle Upon Tyne, UK)

BIOCHEMICAL AND BIOPHYSICAL PROPERTIES

The nucleic acid of the alphaviruses consists of a single-stranded (ss) positive-sense RNA, almost 12 000 nucleotides in length, which is capped at the 5' end and polyadenylated at the 3' end (Figure 16.2). The naked genome is infectious (Strauss and Strauss, 1986). The sedimentation coefficient has been reported to be 42–49. The genome is divided into two regions. The 5' two-thirds of the viral genome codes for the non-structural proteins and the 3' third encodes the structural proteins (Strauss *et al.*, 1984). Both the structural and non-structural proteins are translated as polyprotein precursors. The non-structural polyprotein precursor is cleaved into four non-structural proteins, NSP1, NSP2, NSP3 and NSP4. These function as the replicase/transcriptase of the virus (Strauss and Strauss, 1986). The structural polyprotein precursor is cleaved to form three major polypeptides. The capsid protein C (30–40 kDa) and the envelope glycoproteins E1 and E2 (45–59 kDa) are found in ma-

ture alphavirus particles. In addition, a small glycoprotein termed E3 has been demonstrated in Semliki Forest virus (Garoff *et al.*, 1974). A further small 6K polypeptide is also encoded, but has not been demonstrated in any alphavirus particles.

REPLICATION

Viral attachment to a host cell occurs via the glycoprotein spikes on the viral surface. The envelope glycoproteins have receptors which are essential to initiate infection. Alphaviruses are able to infect both vertebrate and arthropod hosts and enter the host cell by endocytosis or direct fusion with the plasma membrane. After endocytosis the capsid is thought to be released by low-pH catalysed membrane fusion initiated by the E1 glycoprotein (Wang *et al.*, 1992). Once released, the positive-sense ssRNA probably serves as an mRNA. A virus encoded transcriptase transcribes the positive-sense RNA into minus-stranded RNA, which then forms a template for the synthesis of the positive-stranded progeny RNA. Nucleocapsids are assembled in the cytoplasm and maturation occurs by budding through host cell membranes.

ANTIGENIC AND GENOTYPIC PROPERTIES

The alphaviruses have a group-reactive nucleoprotein. Complex and type-specific reactivity is determined by the envelope glycoproteins. This antigenic comparison of alphaviruses has been conducted using haemagglutination-inhibition (HI) and complement fixation tests (CF) as well as cross-protection tests in mice and neutralization tests in cell culture (Calisher *et al.*, 1980). The E1 glycoprotein of Sindbis contains the antigen responsible for haemagglutination (Chanas *et al.*, 1982). It is assumed that this is also the case for other members of the genus *Alphavirus*. The E2 glycoprotein induces virus-specific neutralizing antibody. On the basis of this, alphaviruses have been divided into six antigenic complexes: Western equine encephalitis (WEE), Venezuelan equine encephalitis (VEE), Eastern equine encephalitis (EEE), Semliki Forest (SF), Middleburg and Ndumu viruses (Peters and Dalrymple, 1990). A further virus Barmah Forest virus has been shown to be biochemically typical of the genus, but is not related serologically to mem-

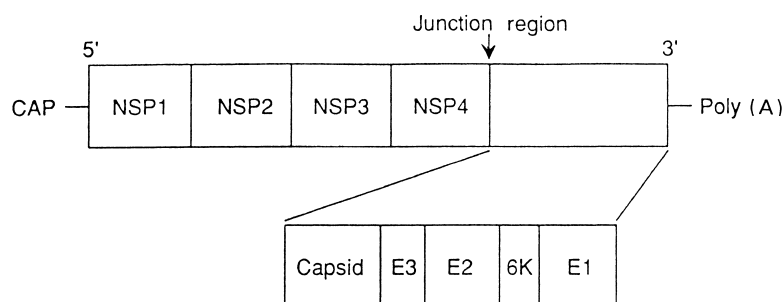

Figure 16.2 Organization of the alphavirus genome. The 5' two-thirds of the viral genome encode the non-structural proteins, NSP1, NSP2, NSP3 and NSP4. The 3' third encodes the structural proteins. The capsid and envelop glycoproteins (E1 and E2) are present in mature alphavirus particles. A third glycoprotein, E3, has been demonstrated in purified SFV. The 6K polypeptide is not known to be a structural protein

Table 16.1 Antigenic classification of alphaviruses and their global distribution

Antigenic complex	Species (virus)	Geographical distribution
Western equine encephalitis (WEE)	WEE	Americas
	Y 62-33	Asia
	Highlands J	North America
	Fort Morgan	North America
	Aura	South America
	Sindbis	Worldwide
Venezuelan equine encephalitis (VEE)	VEE	The Americas
Eastern equine encephalitis (EEE)	EEE	North & South America
	Semliki Forest	Africa & Asia
Semliki Forest	Chikungunya	Africa & Asia
	Getah	Asia & Australasia
	Mayaro	South America
	Middelburg	South, West and Central Africa
Nduma	Nduma	South, West and Central Africa
Barmah Forest	Barmah Forest	Australia

Adapted from Peters and Dalrymple (1990)

bers of the six antigenic complexes (Table 16.1). Each complex consists of either a single virus species having no known close relatives, for example EEE, VEE, Middleburg and Ndumu viruses, or several species, subtypes and varieties that are more closely related to each other than the other members of the genus, for example Semliki Forest virus and WEE virus. These variants can often only be distinguished by plaque reduction or kinetic HI tests. Kinetic HI tests have also been used to differentiate between geographical variants of EEE virus (Casals, 1964). Studies utilizing monoclonal antibodies have been able to define the alphavirus antigenic cross-reactivities more precisely and map the antigenic determinants.

A recent study sequenced one strain of each alphavirus species and this allowed for the classification of alphaviruses into six genotypes (as compared to seven antigenic complexes): Sindbis, Ndumu, VEE, WEE, Barmah Forest and Semliki Forest viruses. The authors included EEE and WEE in the same genotypic complex; this homol-

ogy is to be expected as WEE is thought to be a recombinant virus which derives its non-structural genes from an EEE virus ancestor (Pfeffer *et al.*, 1997).

SPECTRUM OF DISEASE CAUSED BY ALPHAVIRUSES

Alphaviruses cause a wide range of disease in animals and humans, ranging from a clinically inapparent infection to a severe disease that may result in death. The main target organs are muscle, brain, reticuloendothelial system and the joints. This group of viruses may be clinically divided into those that are associated with fever, rash and polyarthritides or those that are associated primarily with encephalitis (Table 16.2). *Middelburg* and *Ndumu* viruses are not known to cause disease in humans. Some alphaviruses are also responsible for disease in animals, particularly *Equidae*.

Table 16.2 Range of human illness caused by alphaviruses

Clinical features	Virus
Fever, rash	Sindbis, Ockelbo
Fever, rash, polyarthritits	Ross River, Barmah Forest
Fever, rash, myalgia, arthralgia	Chikungunya, O'nyong-nyong, Mayaro, Sindbis, Ockelbo Ross River, Barmah Forest, Igo Ora
Fever, encephalitis	Eastern equine encephalitis Western equine encephalitis Venezuelan equine encephalitis Everglades, Semliki Forest

DIAGNOSIS OF ALPHAVIRUS INFECTIONS

The clinical features in a patient living or having recently travelled to an appropriate geographical region provide an important diagnostic clue. However, differentiation from other viral infections may be difficult. For example, it is sometimes difficult to differentiate infection with *Ross River virus* from infections with rubella, parvovirus B19 or enterovirus infections. Laboratory confirmation of infection may therefore be required.

Laboratory diagnosis includes viral culture, the detection of a specific antibody response and, more recently, the use of molecular techniques to detect viral genome. In general, virus isolation is often only successful when acute-phase antibody-negative serum samples are used, particularly when the serum sample is taken in the first 48 hours of illness. Thereafter the amount of virus in serum drops rapidly and recovery becomes increasingly difficult. Virus identification is facilitated by the use of murine monoclonal alphaviruses-specific antibodies. Virus may be isolated by intracerebral inoculation of baby mice as well as in a variety of cell culture systems, including monkey kidney (Vero) and mosquito (C6/36) cell lines. More recently methods have been developed to diagnose alphavirus infections using genomic detection methods. As these are RNA viruses any polymerase chain reaction (PCR)-based assay must first transcribe the RNA into DNA. A reverse transcription-polymerase chain reaction (RT-PCR) has been developed for the genus-specific detection of alphaviruses. This utilizes degenerate primers localized within a conserved region of the non-structural protein 1 and is likely to be a sensitive and rapid alternative

to virus isolation in the diagnosis of an acute infection (Pfeffer *et al.*, 1997).

Detection of an appropriate specific antibody response is frequently used to diagnose alphavirus infections. Class-specific IgM assays have been developed to diagnose an acute or recent infection with a particular alphavirus. However, care must be taken in the interpretation of the result as cross-reactions may occur with other members of the same alphavirus antigenic complex (Table 16.1) (Calisher *et al.*, 1986). A serological diagnosis of a recent alphavirus infection may also be made by demonstrating a rise in specific antibodies when acute and convalescent serum samples are tested in parallel. This is usually done using HI, CF or neutralization tests.

MANAGEMENT AND PREVENTION

Management of alphavirus infections is usually supportive and directed at symptomatic relief, for example the symptomatic relief of joint symptoms with non-steroidal anti-inflammatory agents and aspirin. Prevention of alphavirus infections has focused on vector control and the protection of the individual against mosquito bites. A detailed knowledge of the vector and vertebrate host range is therefore essential to allow for a coordinated strategy to prevent and control alphavirus infections. Vaccines are also available against some of the individual alphaviruses infections (see below).

ALPHAVIRUSES ASSOCIATED WITH FEVERS AND POLYARTHRTITIS

Sindbis Virus

Sindbis virus is the prototype of the alphaviruses. It was originally isolated from *Culex* mosquitoes collected in the Egyptian village of Sindbis (Taylor *et al.*, 1955). In Sweden symptomatic disease resulting from infection with a Sindbis-like agent has been termed Ockelbo disease. A Sindbis-related virus has also been described as the cause of Pogosta disease in Finland and as Karelian fever in the Karelian region of the former USSR. *Babanki virus* is a Sindbis-like agent that occurs in West and Central Africa; the clinical significance of infection with this virus remains to be defined (Peters and Dalrymple, 1990).

Epidemiology and Host Range

Sindbis virus occurs in many parts of the world, including Europe, Asia, Africa and Australia. The virus is known to infect humans, domestic animals and birds, with birds forming the principal reservoir. Humans are not considered to be essential to the survival of the virus in nature. *Sindbis virus* is transmitted among birds by the *Culex* mosquitoes. Infection in birds does not appear to result in disease. Where humans and birds exist in close proximity, for example in the Nile Valley, transmission to humans may occur (Peters and Dalrymple, 1990). Studies from South Africa have shown that the virus is distributed widely throughout the country. Transmission to the avian population and probably to humans occurs annually. Extensive human disease only occurs, however, during years of abundant rainfall and flooding (McIntosh *et al.*, 1964; Jupp *et al.*, 1986). In Europe, disease caused by *Sindbis virus* occurs after excursions into forested areas by, for example, lumberjacks or berry pickers. Here the virus has been isolated from *Culiseta*, *Aedes* and *Culex* mosquitoes.

Clinical Features

Sindbis virus is among the least virulent of the alphaviruses. Serological surveys suggest that infection with *Sindbis virus* is relatively common, but clinically apparent disease is unusual. When symptomatic, the spectrum of disease in humans varies from a mild illness to one consisting of a rash and arthralgia. The illness is usually characterized by a sudden onset of the rash, but occasionally prodromal symptoms may be present. The rash is usually macular or papular but may become vesicular or haemorrhagic. Malaise, fatigue and headache are frequently present (McIntosh *et al.*, 1964; Jupp *et al.*, 1986). The initial joint involvement is usually migratory, followed by a gradual resolution of symptoms.

Ockelbo disease was first described in the central part of Sweden in the 1960s in clusters of patients with fever, arthralgia and a rash (Niklasson and Vene, 1996). Some patients with Ockelbo disease have reported joint symptoms persisting for more than a year and recurrent joint problems were documented in one third of a group of Swedish patients interviewed 2 or more years post-infection (Niklasson *et al.*, 1988). By contrast reports from South Africa have emphasized the joint involve-

ment less and have suggested that the involvement is of tendon and periarticular tissue, rather than a true arthritis (McIntosh *et al.*, 1964).

Pathogenesis

It is not clear whether the skin lesions are the result of a direct viral cytopathic effect or are immunopathological. Evidence to support the former hypothesis comes from Malherbe and Strickland-Cholmley (1963) who demonstrated the isolation of *Sindbis virus* from a vesicle in the absence of a serum viraemia. This was associated with a subsequent rise in specific antibody. Other workers have, however, failed to isolate *Sindbis virus* from skin lesions (McIntosh *et al.*, 1964). The pathogenesis of the joint complications, and whether they are articular or periarticular, is also unclear.

Diagnosis

Isolation of *Sindbis virus* from human sera has been reported, but this is frequently not successful, even using sera taken early on in the illness. This is because the viraemia associated with *Sindbis virus* infection is often of low level and transient. In addition, medical attention is frequently sought relatively late in the course of the illness. As mentioned above, *Sindbis virus* has also been isolated from a skin lesion. When inoculated into 3–5-day-old mice, either intracerebrally or intraperitoneally, *Sindbis virus* causes a fatal infection which is preceded by a short period of paralysis. The virus has also been isolated *in vitro* in fibroblastic cell lines. Antibodies appear 7–10 days after the onset of illness and may be detected by HI, CF and immunofluorescence (IF) (McIntosh *et al.*, 1964; Doherty *et al.*, 1969; Espmark and Niklasson, 1984). Although the detection of *Sindbis*-specific IgM may be of use in diagnosis an acute infection, this class of antibody may remain detectable 3–4 years after the initial infection. A positive IgM result must therefore be interpreted together with the available clinical information.

Ross River Virus

Infection with *Ross River virus* (RRV), also known as epidemic polyarthritis, is a major public health problem in Australia. It is the most common arboviral infection of humans in Australia. In the late

Table 16.3 Geographical distribution of the Semliki Forest virus complex

Species	Subtype	Geographical distribution
Semliki Forest Chikungunya	Semliki Forest	Africa
	Chikungunya	Tropical Africa, South & South-East Asia, Philippines
	Igbo Ora O'nyong-nyong	West & Central Africa East & West Africa, Zimbabwe
Mayaro	Mayaro	South America
	Una	South and Central America
Getah	Getah	Malaysia, Japan, Australia, Cambodia, South Pacific
	Ross River	Australia, South Pacific
	Bebaru	Malaysia
	Sagiyama	Japan, Okinawa

1970s and early 1980s RRV also became endemic in the Pacific Islands (Table 16.3). In recent years it has also been identified in travellers returning to Europe.

Epidemiology and Host Range

Until 1979 the distribution of RRV infections was thought to be limited to Australia, New Guinea and the Solomon Islands, all in the western half of the Pacific basin. In Australia both epidemic and sporadic transmission of RRV occurs. Epidemics are characteristically preceded by heavy rainfall and are located in river valleys and irrigated lands in coastal areas. However, other factors such as temperature, are important—a sudden period of cold can delay the build-up of the vector and so abort an epidemic (Hawkes *et al.*, 1985). The virus was first isolated from *Aedes vigilax*, which is accepted as being the major vector in the coastal regions of Australia. Other mosquito species, including *Aedes comptorhynchus* and *Culex annulirostris*, are also thought to be important vectors (Peters and Dalrymple, 1990). Besides humans, other possible vertebrate hosts include marsupials, domestic animals and rodents (Doherty, 1977).

In 1979 an explosive epidemic of RRV infection occurred in Fiji (Aaskov *et al.*, 1981). The virus spread to American Samoa and then to the Wallis and Futuna Islands and the Cook Islands. The mosquito vector in this region is unknown although the virus has been isolated from *Aedes polynesiensis*, a mosquito that is found in many parts of the Eastern Pacific (Rosen *et al.*, 1981). Evidence suggests

that humans are the most important vertebrate host in this region. A study from the Cook Islands showed that the incubation period could be as short as 3 days and the explosive nature of this epidemic led to speculation that mechanical transmission of RRV may occur. This theory has been supported by laboratory evidence of mechanical transmission of RRV from viraemic donors to uninfected recipient suckling mice. In addition, it has also been suggested that transovarial transmission in mosquitoes is a potential survival mechanism for this virus (Kay, 1982).

Clinical Features

Infection with RRV does not necessarily result in disease in humans and it has been estimated that 50 subclinical infections occur for each clinically recognized case. Adults are more likely to be symptomatic than children. The onset of clinical symptoms is characterized by joint pains (epidemic polyarthritides) accompanied by a rash and fever. In a recent postal survey of general practitioners in south Australia the complaint of 'pain in the joints' was the most important symptom for suspecting an infection with RRV, with joint effusion, rash and pyrexia being important signs (Stocks *et al.*, 1997). The rash may occur simultaneously with the joint pains or may follow 1–2 days later. Although the rash is usually macular, maculopapular or papular, vesiculation and petechiae have been described. The rash and joint pains are commonly accompanied by some degree of constitutional upset, including myalgia, headache, anorexia and nausea. The joint involvement is usually asymmetrical and migratory and most often affects the small joints of the hands and feet together with the knees. In addition, there may also be periarticular swelling and a tenosynovitis (Clarke *et al.*, 1973; Hawkes *et al.*, 1985). The arthralgia and arthritis tends to run a relapsing course but with an overall gradual improvement. The symptoms of epidemic polyarthritides may last for 30–40 weeks, with some patients having symptoms for more than a year. While joint pain, rash and fever are the most common clinical features, glomerulonephritis has also been reported in the acute phase of RRV disease (Fraser *et al.*, 1988). This case report describes a patient presenting with haematuria and proteinuria coincident with an acute RRV infection; the frequency of this complication has yet to be defined.

Pathogenesis

The pathogenesis of disease is not completely understood. While virus has been isolated from the blood, it has not been isolated from either the skin or joints. However, RRV antigen has been detected by immunofluorescence at both of these sites. Histological examination of the skin lesions shows a mononuclear cell infiltration (Fraser *et al.*, 1983). It has also been shown that RRV is capable of infecting human synovial cells (Cunningham and Fraser, 1985). Serum complement is normal and circulating immune complexes do not usually exceed normal levels. It has therefore been suggested that RRV plays a direct role at these sites of inflammation.

Diagnosis

Isolation of RRV is only successful using acute-phase antibody-negative serum samples. Both mosquitoes and mosquito cell lines have been used. The current method of choice for RRV isolation is the inoculation of the mosquito cell line, C6/36. As this virus does not display a cytopathic effect in C6/36 cells, viral antigen is detected using IF (Rosen *et al.*, 1981). RRV may also be isolated in Vero (E6) cells. More recently methods have been developed to detect RRV RNA using RT-PCR. This methodology has potential application to virus surveillance programmes in mosquito populations (Sellner *et al.*, 1994).

While virus may be isolated in an appropriate cell culture system, an acute infection is frequently confirmed serologically. This may be done using the classical serological methods and HI and neutralization. The development of HI antibodies differs in patients from Australia when compared to those from the Pacific Islands. In the Australian cases described most patients have detectable HI antibodies in the first week of illness (Clarke *et al.*, 1973). In contrast, HI antibodies appear to become detectable later in patients from the Pacific Islands, usually only after the first week of symptoms (Rosen *et al.*, 1981). The reason for this difference is not known. CF antibodies appear later and a seroconversion may be demonstrated using acute and convalescent serum samples. This is not, however, the method of choice as cross-reactivity has been observed with antibodies produced during other alphavirus infections. A more precise diagnosis can be made using neutralization tests (Kanamitsu *et al.*, 1979). More recently a variety of methods have been

used to detect RRV-specific IgM antibodies, including indirect IF and an IgM-capture ELISA. IgM antibody cross-reacts with *Mayaro*, *Chikungunya* and *Semliki Forest viruses* in patients with RRV infections (Table 16.3). However, ratios of homologous to heterologous IgM titres are usually high and so, although this cross-reaction somewhat limits the diagnostic usefulness of this test, it can provide a reasonably specific and rapid diagnosis in an epidemic situation (Calisher *et al.*, 1986). A further complicating factor is the persistence of the IgM response; it has been shown that the IgM reactivity may persist for 1–2 years after the acute infection (Carter *et al.*, 1985). The presence of RRV-specific IgA or low avidity IgG may help in the diagnosis of a recent infection (Carter *et al.*, 1987).

Vaccine

An inactivated RRV vaccine is currently being developed. Preliminary studies have shown that this candidate vaccine neutralized all strains of RRV tested, but to different degrees (Aaskov *et al.*, 1997). Further studies are awaited with interest as, while RRV does not usually cause a severe disease, it may result in considerable morbidity with an associated loss of productivity.

Barmah Forest Virus

This alphavirus has been recently reported to cause both clinical and subclinical infections in Australia. Clinical disease resulting from BFV infection was first reported in 1986. The first epidemic of human disease occurred in 1992 in the Northern Territory (Mackenzie *et al.*, 1994). To date, Australia is the only country in which this virus has been detected (Hills, 1996).

Barmah Forest virus (BFV) is the sole member of the seventh alphavirus serocomplex (Table 16.1). The nucleotide sequence of the BFV genome has recently been described and, from amino acid sequence comparisons with sequenced alphaviruses, BFV has been shown to be most closely related to RRV and *Semliki Forest virus* (Lee *et al.*, 1997). In recent years there has been an apparent increase in incidence of polyarthritis caused by BFV. This prompted a study on the molecular epidemiology of this alphavirus which showed a high degree of sequence homology between BFV isolates with no

evidence of geographical or temporal divergence (Poidinger *et al.*, 1997).

Epidemiology and Host Range

Barmah Forest virus has been isolated from the two most common vectors of RRV—*Culex annulirostris* and *Aedes vigilax*. Occupational and recreational exposure to these vectors is therefore an important risk factor for infection with this virus. A higher incidence of antibodies to BFV in RRV antibody-positive blood donors compared to RRV antibody-negative blood donors suggests a common ecology. Further information is required on the duration of viraemia in humans to determine whether other vertebrate hosts are of importance in viral maintenance.

Clinical Features

As mentioned above, both clinical and subclinical infections occur. The most common symptoms noted in a study from Queensland were arthritis/arthralgia, myalgia and fever, which were present in approximately 75% of patients. In addition, half the patients in this study had a rash (Phillips *et al.*, 1990). A more recent study from New South Wales reported lethargy (89%), joint pain (82%) and rash (68%) as the most common symptoms. In the latter study just over half of the patients reported an illness lasting for more than 6 months. These authors also reported a possible association between the presence of a rash and an improved prognosis (Beard *et al.*, 1997). In general, the symptoms are similar to those associated with RRV infection; laboratory confirmation is therefore necessary to achieve a precise diagnosis. The wider availability of serological testing for BFV infections has also enabled their more unusual features to be described. Recently the first case of glomerulonephritis after BFV infection was diagnosed. The authors suggest that BFV infection should be considered as a possible aetiological agent for glomerulonephritis (Katz *et al.*, 1997).

Diagnosis

Clinical differentiation from RRV infection in patients living in endemic areas is difficult. Laboratory confirmation is therefore necessary for a precise diagnosis to be made. BFV has been isolated from a patient in the mosquito cell line, C6/36. The

serological response to infection with this virus in humans remains to be defined precisely. However, in contrast to RRV infections, where the antibody response may be delayed for 7 days, a recent study demonstrated the presence of both HI and neutralizing antibody titres in two patients with BFV infection at the onset of symptoms (Phillips *et al.*, 1990). This could either be due to a different serological response to these two viruses or, alternatively, BFV-associated disease may have a less clearly defined onset than that caused by RRV infections.

Chikungunya Virus

This virus was first isolated from patients and mosquitoes in the Newala district of Tanzania in 1952–1953. The name is derived from a local term for the illness and means ‘that which bends up’, referring to the crippling arthralgia and arthritis associated with infection with this virus. *Chikungunya virus* is found in the savannahs and forests of tropical Africa as well as in many parts of Asia, including Thailand, Cambodia, Vietnam, Burma, Sri Lanka and India (Table 16.3). The chikungunya strains from Africa and Asia have been shown to be closely related, using a panel of monoclonal antibodies prepared against strains from Africa and Asia (Blackburn *et al.*, 1995).

Epidemiology and Host Range

The epidemiology of chikungunya virus infections differs in Africa and Asia. In Africa this virus is transmitted by *Aedes* mosquitoes. The most important vertebrate in the cycle of infection is the non-human primate, for example baboons and *Cercopithecus* monkeys. Bushbabies and certain species of bats may also be infected in nature, but their role in viral maintenance is likely to be of secondary importance. Humans may be infected in African villages and rural areas, particularly where *Aedes aegypti* is present in large numbers. In contrast to the situation in Africa, transmission in Asia is primarily from human to human by *Aedes aegypti*. It has been suggested that infection with this virus may be common in certain parts of Africa. For example, 47% of sera collected from 132 adults living in the Karamoja district of Uganda had detectable antibodies to *Chikungunya virus* by HI (Rodhain *et al.*, 1989).

Although the most important vector for chikungunya virus transmission to humans is the *Aedes* mosquito, transmission has also been described by *Mansonia africana*. The active replication of alphaviruses in the mosquito is essential for perpetuation in nature, but the explosive nature of the chikungunya epidemics has led to speculation that mechanical transmission of the virus may also occur from a viraemic host by an uninfected mosquito (Peters and Dalrymple, 1990).

Clinical Features

The incubation period varies but is usually 2–4 days. In adults there is an abrupt onset of fever, headache and severe joint pains without prodromal symptoms. The joint pains are the dominant complaint and affect mainly the small joints of the hands, wrist and feet. This may be associated with an erythematous flush over the face and upper chest in approximately 80% of patients. A maculopapular rash together with a generalized lymphadenopathy appears 3–4 days later. Although the arthralgia may resolve within a few weeks, pain, swelling and morning stiffness may continue for months and even years after infection. Petechiae and bleeding from the gums does occur, but there are no significant haemorrhagic manifestations.

In contrast to the clinical presentation in adults, a study from Bangkok concentrating on a paediatric outpatient department showed that the most frequent presenting symptom of chikungunya virus infection in children was vomiting, which was present in 35% of patients. In addition, 18% had abdominal pain or anorexia. None of the patients in this study were noted to have joint symptoms; arthritis and arthralgia therefore appear to be less prominent features in children. On clinical examination of this paediatric population the most frequent sign was a pharyngitis, which was present in 71% of patients, followed by facial flushing (24% of patients). None of these children had a rash. This study illustrates very clearly that the clinical presentation of chikungunya infections in adults and children differs (Halstead *et al.*, 1969).

Haemorrhagic forms of chikungunya virus infection have been described in India and southeast Asia, but these are seldom as severe as dengue haemorrhagic fever. In a hospital-based study in Bangkok about 8% of children with suspected haemorrhagic fever had chikungunya virus infection (Nimmannitya *et al.*, 1969).

Pathogenesis

Chikungunya virus may be isolated from the blood early in the course of disease. As the disappearance of the viraemia correlates with the appearance of HI and neutralizing antibodies, it would appear that recovery from infection correlates with the development of viral-specific antibody rather than cell-mediated immunity. This is further substantiated by the effect of serum antibody in mouse protection tests (Carey *et al.*, 1969). The haemostatic abnormality seen in both children and adult patients is possibly the result of an acquired platelet defect as it has been shown that the association of *Chikungunya virus* with human platelets *in vitro* promotes platelet clumping (Chernesky and Larke, 1977).

Diagnosis

The clinical features described above in a patient who has recently returned from, or is living in, sub-Saharan Africa or Asia enables a presumptive clinical diagnosis to be made. In addition, a minority of patients will have a leucopenia with a relative lymphocytosis. In most, however, the white cell count will be normal. The platelet count may be decreased, but this is usually not significant.

Chikungunya virus can be isolated by the intracerebral inoculation of suckling mice or by viral culture in either mosquito or mammalian cell culture systems (Peters and Dalrymple, 1990). Virus is best isolated from serum samples taken early on in the illness, particularly in the first 48 hours. Thereafter the amount of virus in serum drops rapidly and recovery becomes increasingly difficult. Both HI and neutralizing antibodies appear on day 5–7 of the illness. The appearance of these antibodies is associated with a decrease in viraemia (Carey *et al.*, 1969). HI antibodies rise rapidly and peak in the second week. In contrast, the CF antibody titres rise more slowly. A class-specific IgM assay to diagnose a recent or acute chikungunya virus infection has been described. However, cross-reaction occurs with other members of the same alphavirus antigenic complex, so the results obtained must be interpreted with caution (Table 16.1) (Calisher *et al.*, 1986). The use of a specific IgM assay may be especially relevant in an epidemic situation. This was illustrated in an outbreak in Yangon in Burma. Utilization of a simple indirect ELISA was helpful in achieving an acute-phase diagnosis and results showed a strong concordance with HI (90% agree-

ment), although ELISA was able to identify twice as many patients at initial hospital admission (Thein *et al.*, 1992). The differential diagnosis within the laboratory should include dengue, Sindbis and West Nile virus infections.

Vaccine

A formalin-inactivated chikungunya virus vaccine prepared in monkey kidney tissue culture has been described. Despite being apparently safe and immunogenic, its use has been limited to initial safety studies and laboratory workers (Harrison *et al.*, 1971). More recently a live-attenuated vaccine has been produced.

O'Nyong-Nyong Virus

O'nyong-nyong literally means 'weakening of the joints'. It was first described as an epidemic viral disease in East Africa (Haddow *et al.*, 1960). Antigenically *O'nyong-nyong virus* is a subtype of the species *Chikungunya* (Table 16.3).

Epidemiology and Host Range

The initial epidemic began in 1959 in northwestern Uganda and spread from there to Kenya, Tanzania, Mozambique, Malawi and Zaire. It involved some 2 million people. Within an infected area spread was rapid, with an extremely high attack rate. In an affected village a high proportion of the population, regardless of age or sex, were incapacitated. This disease was also apparently unknown to the tribes who were affected. The origin of *O'nyong-nyong virus* is not clear. It might have existed unrecognized prior to the initial epidemic described above, or, conversely, the epidemic may well have resulted from a mutant or recombinant virus. The vectors of this virus are *Anopheles funestus* and *Anopheles gambiae*. It is not known whether a non-human vertebrate host exists. After this initial epidemic very little further information on this virus was obtained until 1978 when it was isolated from *Anopheles funestus* mosquitoes in the Kano Plain in Kenya (Johnson *et al.*, 1981). The re-emergence of epidemic o'nyong-nyong fever in southwestern Uganda after an absence of 35 years has recently been described (Rwaguma *et al.*, 1997).

Clinical Features

The clinical features are similar to those of chikungunya virus infections, with a sudden onset of joint pains followed by the development of a rash.

Diagnosis

Virus may be isolated in one day old mice from serum samples taken during the acute stage of the infection. However, mouse passage or subinoculation into chick fibroblasts may be necessary. The mice demonstrate alopecia and runting. The virus may then be further identified using plaque inhibition, cross-neutralization assays or HI (Williams and Woodall, 1961.) Antibodies to *O'nyong-nyong virus* may be detected by CF, HI, ELISA, IF and neutralization assays. Interpretation may be difficult due to cross-reaction with *Chikungunya virus*. In general, however, the antibody titre to the homologous virus will be higher than that to the heterologous virus (Peters and Dalrymple, 1990).

Igbo Ora Virus

Igbo Ora virus is closely related to both *Chikungunya* and *O'nyong-nyong viruses*. Human disease associated with infection with this virus is characterized by fever, arthritis and the development of a rash ('the disease that breaks your wings'). The virus was isolated from human sera from patients in Africa (Nigeria, Central African Republic) in the latter part of the 1960s (Moore *et al.*, 1975) and was responsible for an epidemic that involved four villages in the Ivory Coast in 1984 (Peters and Dalrymple, 1990).

Mayaro Virus

Although infection with *Mayaro virus* was first recognized in Trinidad in 1954, it was an epidemic in Brazil in 1978 which permitted a detailed evaluation of human infections (LeDuc *et al.*, 1981; Pinheiro *et al.*, 1981).

Epidemiology and Host Range

During the extensive epidemic described by LeDuc and colleagues (1981), 20% of the entire population

of approximately 4000 persons in the rural village of Belterra in Brazil were infected. The numbers infected were higher amongst those who lived near a plantation forest. The epidemic began with the onset of the wet season and ended with the onset of the dry season. This correlated with the abundance of the mosquito vector, *Haemagogus janthinomys*. In addition to humans, marmosets and other primates are susceptible to infection (Hoch *et al.*, 1981). It has therefore been suggested that non-human primates play an important role in the maintenance of this virus, as experimental infection of marmosets with *Mayaro virus* showed that a significant viraemia develops. The role of other vertebrates, for example birds, remains to be defined.

Clinical Features

A detailed evaluation of the clinical features of infection with this virus in humans is available from studies done during the 1978 epidemic in Brazil. Fever, arthralgia and rash were the most frequently encountered clinical manifestations. Other symptoms included headache, myalgia and chills (Pinheiro *et al.*, 1981).

Diagnosis

Leucopenia, sometimes accompanied by a modest lymphocytosis, is a frequent finding. A mild thrombocytopenia may also be present. *Mayaro virus* may be isolated from acute phase serum samples in an *in vitro* cell culture system using Vero cells. The virus may then be identified using HI or plaque reduction neutralization tests. In addition, *Mayaro virus* is also pathogenic for infant mice on intracerebral inoculation. In the Belterra epidemic, virus was isolated from the serum in 97% (31/32) of the patients bled in the first 24 hours after the onset of symptoms. Thereafter viral recovery rates decreased to only 7% (1/15) on day 4. Serological evidence of a mayaro virus infection can be achieved by demonstrating a seroconversion using HI in paired serum samples taken from a patient during the acute and convalescent phase of the illness (Pinheiro *et al.*, 1981). In addition, the use of a mayaro virus-specific IgM assay has been described. Cross-reactivity of IgM antibody occurs with alphavirus infections by viruses belonging to the same antigenic complex (Table 16.1). However, the ratios of the homologous to heterologous IgM titres are high, allowing a reasonably specific and rapid diagnosis to be made.

The IgM assay is therefore a useful diagnostic tool in an epidemic situation (Calisher *et al.*, 1986).

ALPHAVIRUSES ASSOCIATED WITH ENCEPHALITIS

Eastern equine encephalitis (EEE), *Western equine encephalitis* (WEE) and *Venezuelan equine encephalitis* (VEE) viruses have all been associated with encephalitis in humans. The severity of disease associated with infection with this group of viruses differs: EEE virus is the most neurovirulent, while infection with VEE virus is associated with a febrile illness, with encephalitis occurring infrequently. EEE virus is found in the Americas, WEE virus in the western USA and Canada and VEE virus in Central America and South America.

Eastern Equine Encephalitis Virus

Eastern equine encephalitis virus is an important cause of human disease in the eastern states of the USA, but its distribution extends through Central America to Trinidad, Brazil, Guyana and as far south as Argentina. This virus is among the most virulent of the alphaviruses. It causes severe disease in humans, certain species of birds such as the pheasant, as well as horses, all of whom have high fatality rates after infection.

Epidemiology and Host range

The physical, biological and ecological factors associated with epizootic transmission are complex, but the abundance of EEE virus circulating in the enzootic cycle and the various characteristics of the epizootic vectors are important determinants of risk. In endemic areas birds are the most important vertebrate host and the natural cycle is between birds and the ornithophilic mosquito, *Culiseta melanura*. Birds vary in their susceptibility, with some, for example the pheasant, developing severe disease, while other avian species suffer no appreciable morbidity or mortality (Peters and Dalrymple, 1990). *Culiseta melanura* is thought to be the main endemic vector (Howard and Wallis, 1974). However, because of its ornithophilic nature this mosquito is unlikely to play a major role in the transmission of EEE virus to horses or humans. Other mosquitoes such as *Aedes* and *Coquillettidia* are thought to be important in the transmission to

these vertebrates. Both humans and horses are 'dead-end' hosts for EEE virus infections; infected birds are therefore necessary for the epidemic spread to these species. Disease in humans often follows an epizootic course in horses. Fewer than 10 cases of EEE are reported annually in the USA. Even during a major equine epizootic, EEE virus-associated disease in humans is rare. In addition to being limited to certain geographical regions, the prevailing climatic conditions, in the form of an unusually hot, wet summer, also play an important role, for this allows for an abundance of the vector *Culiseta melanura*. This, together with the presence of a susceptible bird population and an additional vector that can transmit virus from viraemic birds to susceptible horses and humans, are important predisposing factors for the occurrence of human and equine cases.

Clinical Features

EEE virus infections may produce a severe, often fatal encephalitis in humans. The ratio of inapparent to apparent infections is approximately 23:1 in adults and 8:1 in children under the age of 4 (Goldfield *et al.*, 1968). The encephalitis associated with EEE virus infection tends to be fulminant; a recent study, which reviewed all cases of EEE in the USA between 1988 and 1994, showed a mortality of 36%, with 35% of patients being left moderately or severely disabled. The remaining patients were left mildly disabled, with only one patient recovering fully. The most common clinical features were fever (83%), headache (75%), nausea and vomiting (61%) and malaise and weakness (58%). Most patients had a prodromal illness which lasted for a median of 5 days. However, the onset of neurological symptoms was associated with a rapid deterioration of the patient. Eighty-nine % (32 of 36 patients) were or became stuporous or comatose, with about one-quarter having seizures. Interestingly, abdominal pain was present in 22% of cases, with two patients presenting with acute abdominal pain in the prodromal period (Deresiewicz *et al.*, 1997). Although it has been suggested that an age of over 40 and a long prodromal course correlates with a good functional recovery (Przelomski *et al.*, 1988), others have found that these parameters do not significantly predict outcome (Deresiewicz *et al.*, 1997). Deresiewicz and colleagues did, however, demonstrate that high initial cerebrospinal fluid white cell counts and the development of severe hyponatraemia were poor

prognostic signs, possibly because both could be markers of intense cerebral inflammation (Deresiewicz *et al.*, 1997).

Pathogenesis and Pathology

Postmortem histopathological studies have demonstrated necrotic foci together with arteriolar and venular inflammation and perivascular cuffing. An inflammatory meningeal infiltrate may be present. Although the distribution of the focal lesions may vary, involvement of the basal ganglia and thalami appears to be prominent (Deresiewicz *et al.*, 1997). Viral particles have been visualized in the oligodendroglial cells by electron microscopy (Bastian *et al.*, 1975). The neurological damage is probably due to a combination of a direct viral cytopathic effect, inflammatory damage and a vasculitis (Peters and Dalrymple, 1990).

Diagnosis

A diagnostic clue may be obtained from the prevailing climatic conditions (a hot wet summer), together with associated illness in the horse and pheasant populations. However, the symptoms are non-specific and confirmation needs to be obtained serologically or by demonstration of virus in cerebrospinal fluid or both. Neuroradiological imaging may be helpful, with focal lesions visible in the basal ganglia, thalami and brainstem (Deresiewicz *et al.*, 1997).

As with all alphavirus infections, an acute serum sample should be taken as soon as possible after the onset of illness. EEE virus has been isolated from a laboratory worker on the second day of illness (Clarke, 1961). In this case four of 25 1-day-old mice died after intracerebral inoculation with a serum sample taken from this patient. Further identification was done serologically. In addition, virus has also been isolated from postmortem brain tissue taken from a fatal case of EEE. More recently an RT-PCR based assay has been developed to detect EEE virus RNA (Voskin *et al.*, 1993).

Serology is an important diagnostic tool. Paired serum samples may be tested in parallel using HI or neutralization tests. A class-specific IgM assay has also been described as a rapid and specific diagnostic tool. As EEE virus is the only species of virus belonging to the EEE complex (Table 16.1), cross-reaction with heterologous viruses belonging to the

Table 16.4 Geographical distribution of the western equine encephalitis virus complex

Species	Subtype	Geographic distribution
Western equine encephalitis (WEE)	WEE	North America, Mexico, Guyana, Brazil, Argentina
Y 62-33		Asia
Highlands J		Florida, Eastern USA
Fort Morgan		Western USA
Aura		Brazil, Argentina
Sindbis	Sindbis	Africa, Asia, Australasia, Europe
	Babanki	Western & Central Africa
	Ockelbo	Scandinavia, former USSR
	Kyzylagach	Azerbaijan SSR
	Whataroa	New Zealand

same antigenic complex does not pose a diagnostic problem (Calisher *et al.*, 1986).

Prevention and Control

Protection against mosquito bites and control of the vector is important. An effective equine vaccine is licensed in the USA and is recommended for livestock in areas where EEE virus transmission is known to occur. Specific control measures to prevent human disease include a formalin-inactivated vaccine. However, as human disease is rare, even during an equine epizootic, this is only available to those considered to be at risk of exposure. Prompt notification of suspected cases of arboviral encephalitis to the local public health authority is also essential.

Western Equine Encephalitis Virus

Western equine encephalitis virus causes more human infections than the EEE virus, but the illness is less severe and mortality seldom exceeds 10%. Its distribution covers the Pacific coast of the USA, but also includes the great plains of the USA and Canada and extends into Central America and the northern parts of South America. The WEE antigenic complex consists of six species (Table 16.4). It has been suggested that WEE virus arose through recombination between a EEE virus-like virus and a Sindbis-like virus (Hahn *et al.*, 1988).

Epidemiology and Host Range

WEE virus is transmitted in the western USA by the mosquito *Culex tarsalis*. Birds are the most import-

ant vertebrate host. Endemic transmission results in a few human cases. In addition, major equine epidemics may result in a significant number of human cases. As with other arboviruses, climatic factors exert a major influence on the epidemiology and distribution of WEE virus. In the eastern USA WEE virus is replaced by *Highlands J virus*, whose primary vector is *Culiseta melanura*, which is also the primary vector of EEE virus. The strictly ornithophilic nature of this vector explains the absence of significant disease outbreaks in the eastern USA. WEE virus and *Highlands J virus* are closely related both serologically and at a molecular level.

Clinical Features

Asymptomatic infection in adults is common, with an estimated case:infection ratio of approximately 1:1000. This decreases to approximately 1:60 in children and 1:1 in babies (Peters and Dalrymple, 1990). Most cases of encephalitis occur in children, frequently under the age of 4 years, in whom the onset is marked by convulsions. This may result in permanent neurological damage. Drowsiness, headache and mental confusion, sometimes leading to coma, may be seen in adults. *In utero* infection followed by an acute encephalitis has been documented (Shinefield and Townsend, 1953). Recovery from the acute illness may be slow and symptoms such as fatigability, irritability and headache may persist for up to 2 years (Earnest *et al.*, 1971).

Pathogenesis and Pathology

WEE virus is less neurovirulent than EEE virus both in humans and horses. Postmortem examination of the brain of fatal cases shows a perivascular

Table 16.5 Geographical distribution of the Venezuelan equine encephalitis virus complex

Species	Subtype	Variant	Geographical distribution
Venezuelan equine encephalitis (VEE)	I	1A-B, C, D, E, F	Americas
	II	Everglades	Florida, USA
	IIIA	Mucumbo	South America
	IIIB	Tonate	South America
		Bijou Bridge	North America
	IV	Pixuna	South America
	V	Cabassou	South America
	VI	AG80-663	Africa

mononuclear and polymorphonuclear infiltrate together with parenchymal necrosis.

Diagnosis

During the acute phase of the illness viral isolation may be attempted from blood, throat swabs or a cerebrospinal fluid samples using suckling mice, but this is frequently not successful. Virus may usually be isolated from brain biopsy material or postmortem brain tissue taken early on in the illness. However, serology, together with the appropriate clinical manifestations in a patient living in or who has recently travelled to an endemic area, forms the most important method of diagnosing of disease associated with infection with WEE virus. Classical serological techniques, for example HI, CF or neutralization can be used to demonstrate a rise in antibody titre between acute and convalescent serum samples. In addition, the detection of WEE virus-specific IgM can provide a rapid acute-phase diagnosis. However, cross-reaction may occur with other viruses within the complex (Table 16.1). Knowledge of the geographical distribution of the viruses within the complex allows interpretation of a positive IgM result together with the appropriate patient details (Calisher *et al.*, 1986).

Prevention and Control

Vector control is an important aspect of the control of all mosquito-borne encephalitides. Outbreaks in humans and horses are associated with unusually high densities of mosquitoes. There is therefore a correlation between *Culex tarsalis* density and human cases of WEE virus infection. Besides vector control, changing behaviour patterns, for example, air-conditioning houses and promoting in-door ac-

tivities may also protect from vector-borne diseases and are complementary to mosquito control programmes (Gahlinger *et al.*, 1986). An inactivated vaccine is available to those at risk.

Venezuelan Equine Encephalitis Virus

As the name suggests, *Venezuelan equine encephalitis virus* was first isolated in Venezuela, where it causes important epizootics in horses, but also infects humans. The geographical distribution includes Central and South America. VEE virus caused epidemics/epizootics among people and horses in Latin America from the 1920s to the 1970s. It reached the USA in 1971, but no further activity was reported until 1992–1993, when a small outbreak in Venezuela confirmed the re-emergence of VEE from its enzootic habitat to humans. This was followed by a major outbreak occurring in 1995, involving an estimated 75 000–100 000 people (Rico-Hesse *et al.*, 1995; Weaver *et al.*, 1996). A variant of the virus, known as *Everglades virus*, is endemic in Florida and another variant, *Mucambo virus*, is found in Brazil, Trinidad and Surinam (Table 16.5).

Epidemiology and Host Range

Both epizootic and enzootic strains of VEE virus occur. Serotypes IAB and IC are equine virulent, while ID, IE and II, III and IV are equine avirulent (Table 16.5) (Weaver *et al.*, 1996). The principal vertebrate host for enzootic transmission is the rodent, although birds and other species may play a less important role. Horses may be infected by several subtypes or variants of VEE (Table 16.5), but they do not play an important role in enzootic

transmission which occurs primarily between small mammals and the *Culex* mosquitoes of the subgenus *Melanoconion* (Cupp *et al.*, 1986). In contrast, during equine epizootics horses do play an important role in viral spread. It has been suggested that epizootic strains of VEE are maintained in other mammalian hosts and birds until the conditions are favourable for the development of an equine epizootic. A number of mosquito species have been implicated as likely vectors during epizootics. Human disease usually follows equine disease, but humans are not thought to be important in the maintenance of the epidemic due to low-titre viraemia.

The major outbreak of VEE that occurred in Venezuela and Columbia in 1995 was remarkably similar to an outbreak occurring in 1962–1964. Both outbreaks followed unusually heavy rains which led to an increase in the mosquito vector, and both occurred in the same geographic region. Phylogenetic analysis showed that isolates from the 1995 epidemic of VEE were closely related to the serotype IC viruses isolated during the 1962–1964 epidemic. As a similar virus was identified in mosquitoes in Venezuela in 1983, the authors raise the possibility of a serotype IC enzootic transmission cycle in northern Venezuela (Weaver *et al.*, 1996).

Clinical Features

In horses, enzootic strains of VEE virus usually produce a fever and mild leucopenia. In contrast to this, horses infected with epizootic strains exhibit high fevers, severe leucopenia and signs of encephalitis. Infections in humans result in a range of symptoms. These may be subclinical or result in clinical symptoms of varying severity. Symptoms and signs in patients seeking medical care include fever, chills, severe headache, myalgia, vomiting and diarrhoea. Most patients will have an acute and self-limiting febrile illness; however, convulsions, disorientation and drowsiness may also be present (Weaver *et al.*, 1996). The proportion of cases that develop neurological sequelae appears to vary from outbreak to outbreak. A review of the medical records of patients with convulsions in the 1995 epidemic showed that, although the age varied greatly (from 2 months to 48 years), most were children; however, only approximately 20% of these were under 3 years of age. Of interest is that about half of these patients had their first seizure between the 5th and 10th day after the onset of their illness and when their temperature had returned to normal (Weaver

et al., 1996). A further prospective study which included a total of 13 patients showed that six patients had a severe incapacitating febrile illness lasting 3–5 days, two others had a ‘flu-like’ illness, and the remaining five (38%) were asymptomatic (Martin *et al.*, 1972). The overall mortality is thought to be less than 1%. Fetal loss may occur in pregnant women with VEE.

Pathogenesis and Pathology

The disease caused by VEE virus in humans is relatively mild compared to that caused by either WEE or EEE viruses. In horses, as well as other species, there is a clear difference in the pathogenicity of the epizootic and the enzootic strains of VEE. Epizootic strains are generally more virulent, with infection in horses resulting in viral replication in the lymphoid tissue and bone marrow. This is associated with lymphoid necrosis and a lymphopenia and is accompanied by a high-titre viraemia. Spread to the central nervous system probably occurs in the bloodstream, resulting in a fatal encephalitis in horses, as well as rodents and some primates (Peters and Dalrymple, 1990).

Diagnosis

The diagnosis of VEE-associated disease should be suspected in patients presenting with a ‘flu-like’ illness in an appropriate geographical region when there is a concurrent equine epizootic. Material obtained from sick horses confirming an epizootic of VEE may therefore be an important indicator of human disease. Isolation of virus may be attempted from acute-phase serum and throat swabs as well as from brain tissue obtained from aborted and still-born fetuses (Weaver *et al.*, 1996). Culture of VEE virus has been achieved by inoculation into Vero or mosquito cells or suckling mice (Dietz *et al.*, 1979). Intracerebral inoculation of suckling mice may result in death within 72 hours. Isolates identified in cell culture may be characterized further using VEE serotype-specific polyclonal sera. Alternatively, genetic characterization may be done using RT-PCR with sequencing of the products generated from the E3 and E4 genes (Weaver *et al.*, 1996).

A number of serological assays (IFA, ELISA, HI) have been described. Acute and convalescent serum samples may be tested in parallel by HI. This may provide diagnostically useful information. More recently attention has been focused on the use of an

IgG ELISA based on an antigen prepared from the attenuated VEE vaccine strain of virus. In experimentally infected guinea-pigs, VEE-specific IgG could be detected at 6 days postinoculation, compared with 10 days for HI antibodies. However RRV, EEE and WEE virus-specific IgG exhibit a weak cross-reaction on the IgG ELISA, so results must be interpreted with caution. The appearance of IgG antibodies detectable by ELISA coincides with the development of antibodies detectable by plaque reduction neutralization assay (PRN). While less sensitive than the IgG ELISA, PRN is more specific and therefore eliminates some of the problems of cross-reaction discussed above. It may therefore be used as a confirmatory test. VEE-specific IgM antibody has been detected as early as 4 days postinoculation in experimentally infected guinea-pigs (at a time at which infectious virus was present in the serum). In summary, suspected cases of VEE virus infection may be investigated serologically using a VEE-specific IgM and IgG ELISA, together with the more specific PRN as a confirmatory test (Coates *et al.*, 1992).

Prevention and Control

Personal protection against mosquito bites together with vector control, as for other alphavirus infections, is important. Control of an equine epizootic by immunizing horses is also important in the prevention of subsequent human disease. Two types of vaccine are currently available for the prevention of VEE in humans and horses. The first is a live attenuated vaccine, TC-83, produced by serial passage of wild virus in guinea-pig fetal heart cell culture. While this vaccine has been proven to be efficacious and relatively safe, 25% of individuals immunized develop a clinical illness with a low-grade viraemia. A formalin-inactivated vaccine, C-84, which is derived from the TC-83 strain of virus, has been shown to be safe and provides effective protection in experimental animals injected with virulent VEE virus but only limited protection from aerosol challenge.

OTHER ALPHAVIRUSES

Semliki Forest virus (SFV) is found in sub-Saharan Africa and has been used as a model virus for research. Although the disease potential for this virus remains to be elucidated, asymptomatic serocon-

versions have been described. However, the clinical features of infection with SFV have not been well defined. One scientist working with SFV developed an encephalitis—SFV was isolated from both cerebrospinal fluid and postmortem brain tissue (Peters and Dalrymple, 1990). This highlights the necessity for caution when working with any infectious agents of unknown pathogenic potential.

Getah virus is closely related to RRV and has been linked to disease in horses (fever, rash and limb oedema). Although it has not been implicated in human disease, serological studies have demonstrated antibodies to *Getah virus* in sera taken from individuals from the Pacific Basin, Japan and Hainan Island in China (Johnson and Peters, 1996).

More recently, a newly recognised alphavirus has been isolated from mosquitoes from the Me Tri village in Vietnam; it appears to be most closely related to SFV and has been associated with central nervous system illnesses in children. It has been proposed that this virus is called 'Me Tri virus'. The contribution of this virus to human disease in southeast Asia remains to be defined (Ha *et al.*, 1995).

REFERENCES

- Aaskov, J.G., Mataika, J.U., Lawrence, G.W. *et al.* (1981) An epidemic of Ross River virus infection in Fiji, 1979. *American Journal of Tropical Medicine and Hygiene*, **30**, 1053–1059.
- Aaskov, J., Williams, L. and Yu, S. (1997) A candidate Ross River virus vaccine: preclinical evaluation. *Vaccine*, **15**, 1396–1404.
- Bastian, F.O., Wende, R.D., Singer, D.B. *et al.* (1975) Eastern equine encephalomyelitis. Histopathological and ultrastructural changes with isolation of the virus in a human case. *American Journal of Clinical Pathology*, **64**, 10–13.
- Beard, J.R., Trent, M., Sam, G.A. *et al.* (1997) Self-reported morbidity of Barmah Forest virus infection on the north coast of New South Wales. *Medical Journal of Australia*, **167**, 525–528.
- Blackburn, N.K., Besselaar, T.G. and Gibson, G. (1995) Antigenic relationship between chikungunya virus strains and o'nyong nyong virus using monoclonal antibodies. *Research in Virology*, **146**, 69–73.
- Calisher, C.H., Shope, R.E., Brandt, W. *et al.* (1980) Proposed antigenic classification of registered arboviruses. 1. Togaviridae, Alphavirus. *Intervirology*, **14**, 229–232.
- Calisher, C.H., El-Kafrawi, A.O., Mahmud, M.I. *et al.* (1986) Complex-specific immunoglobulin M antibody patterns in humans infected with alphaviruses. *Journal of Clinical Microbiology*, **23**, 155–159.
- Carey, D.E., Myers, R.M., DeRainitz, C. *et al.* (1969) The 1964 chikungunya epidemic in Vellore, South India, including observations on concurrent dengue. *Transactions of the Royal Society of Tropical Medicine and Hygiene*, **63**, 434–445.
- Carter, I.W., Smythe, L.D., Fraser, J.R. *et al.* (1985) Detection of

- Ross River virus immunoglobulin M antibodies by enzyme-linked immunosorbent assay using antibody class capture and comparison with other methods. *Pathology*, **17**, 503–508.
- Carter, I.W.J., Fraser, J.R.E. and Cloonan, M.J. (1987) Specific IgA response in Ross River virus infection. *Immunology and Cell Biology*, **65**, 511–513.
- Casals, J. (1964) Antigenic variants of eastern equine encephalitis virus. *Journal of Experimental Medicine*, **119**, 547–565.
- Chanas, A.C., Gould, E.A., Clegg, J.C.S. *et al.* (1982) Monoclonal antibodies to Sindbis virus glycoprotein E1 can neutralise, enhance infectivity and independently inhibit haemagglutination or haemolysis. *Journal of General Virology*, **58**, 37–46.
- Chernesky, M.A. and Larke, R.P.B. (1977) Contrasting effects of rabbit and human platelets on chikungunya virus infectivity. *Canadian Journal of Microbiology*, **23**, 1237–1244.
- Clarke, D.H. (1961) Two non-fatal human infections with the virus of Eastern equine encephalitis. *American Journal of Tropical Medicine and Hygiene*, **10**, 67–70.
- Clarke, J.A., Marshall, I.D. and Gard, G. (1973) Annually recurrent epidemic polyarthritis and Ross River virus activity in a coastal area of New South Wales. I. Occurrence of the disease. *American Journal of Tropical Medicine and Hygiene*, **22**, 543–550.
- Coates, D.M., Makh, S.R., Jones, N. *et al.* (1992) Assessment of assays for the serodiagnosis of Venezuelan equine encephalitis. *Journal of Infection*, **25**, 279–289.
- Cunningham, A.L. and Fraser, J.R.E. (1985) Ross River virus infection of human synovial cells *in vitro*. *Australian Journal of Experimental Biology and Medical Science*, **63**, 197–204.
- Cupp, E.W., Scherer, J.B., Bremner, R.J. *et al.* (1986) Entomological studies at an enzootic Venezuelan equine encephalitis virus focus in Guatemala, 1977–1980. *American Journal of Tropical Medicine and Hygiene*, **35**, 851–859.
- Deresiewicz, R.L., Thaler, S.J., Hsu, L. *et al.* (1997) Clinical and neuroradiographic manifestations of eastern equine encephalitis. *New England Journal of Medicine*, **336**, 1867–1874.
- Dietz, W.H., Peralta, P.H. and Johnson, K.M. (1979) Ten clinical cases of human infection with Venezuelan equine encephalomyelitis virus subtype 1-D. *American Journal of Tropical Medicine and Hygiene*, **28**, 329–334.
- Doherty, R.L. (1977) Arthropod-borne viruses in Australia, 1973–1976. *Australian Journal of Experimental Biology and Medical Science*, **55**, 103–130.
- Doherty, R.L., Bodey, A.S. and Carew, J.S. (1969) Sinbis infection in Australia. *Medical Journal of Australia*, **196**, 1016–1017.
- Earnest, M.P., Goolishian, H.A., Calverley, J.R. *et al.* (1971) Neurologic, intellectual and psychologic sequelae following western encephalitis. *Neurology*, **21**, 969–974.
- Espmark, A. and Niklasson, B. (1984) Ockelbo disease in Sweden: epidemiological, clinical and virological data from the 1982 outbreak. *American Journal of Tropical Medicine and Hygiene*, **33**, 1203–1211.
- Fraser, J.R.E., Ratnamohan, V.M., Dowling, J.P. *et al.* (1983) The exanthem of Ross River virus infection: histology, location of virus antigen and nature of inflammatory infiltrate. *Journal of Clinical Pathology*, **36**, 1256–1263.
- Fraser, J.R.E., Cunningham, A.L., Muller, H.K. *et al.* (1988) Glomerulonephritis in the acute phase of Ross River virus disease. *Clinical Nephrology*, **29**, 149–152.
- Gahlinger, P.M., Reeves, W.C. and Milby, M.M. (1986) Air conditioning and television as protective factors in arboviral encephalitis risk. *American Journal of Tropical Medicine and Hygiene*, **35**, 601–610.
- Garoff, H., Simons, H. and Renkonen, O. (1974) Isolation and characterisation of the membrane proteins of Semliki Forest virus. *Virology*, **61**, 493–504.
- Goldfield, M., Welsh, J.N. and Taylor, B.F. (1968) The 1959 outbreak of eastern encephalitis in New Jersey. 5. The inapparent infection:disease ratio. *American Journal of Epidemiology*, **87**, 32–38.
- Ha, D.Q., Calisher, C.H., Tien, P.H. *et al.* (1995) Isolation of a newly recognised alphavirus from mosquitoes in Vietnam and evidence for human infection and disease. *American Journal of Tropical Medicine and Hygiene*, **53**, 100–104.
- Haddow, A.J., Davies, C.W. and Walker, A.J. (1960) O'nyong-nyong fever: an epidemic virus disease in East Africa. 1. Introduction. *Transactions of the Royal Society of Tropical Medicine and Hygiene*, **54**, 517–522.
- Hahn, C.S., Lustig, S., Strauss, E.G. *et al.* (1988) Western equine encephalitis virus is a recombinant virus. *Proceedings of the National Academy of Sciences of the USA*, **85**, 5997–6001.
- Halstead, S.B., Nimmannitya, S. and Margiotta, M.R. (1969) Dengue and chikungunya virus infection in man in Thailand, 1962–1964. Observations on disease in outpatients. *American Journal of Tropical Medicine and Hygiene*, **18**, 972–983.
- Harrison, S.C. (1986) Alphavirus structure. In *The Togaviridae and Flaviviridae* (eds S. Schlesinger and M.J. Schlesinger), pp 21–34. Plenum Press, New York.
- Harrison, V.R., Eckles, K.H., Bartelloni, P.J. *et al.* (1971) Production and evaluation of a formalin-killed chikungunya vaccine. *Journal of Immunology*, **107**, 643–647.
- Hawkes, R.A., Broughton, C.R., Naim, H.M. *et al.* (1985) A major outbreak of epidemic polyarthritis in New South Wales during the summer of 1983–1984. *Medical Journal of Australia*, **143**, 330–333.
- Hills, S. (1996) Ross River virus and Barmah Forest virus infection. Commonly asked questions. *Australian Family Physician*, **25**, 1822–1824.
- Hoch, A.L., Peterson, N.E., Le Duc, J.W. *et al.* (1981) An outbreak of Mayaro virus disease in Belterra, Brazil. III Entomological and ecological studies. *American Journal of Tropical Medicine and Hygiene*, **30**, 689–698.
- Howard, J.J. and Wallis, R.C. (1974) Infection and transmission of eastern equine encephalitis virus with colonised *Culiseta melanura* (Coquillett). *American Journal of Tropical Medicine and Hygiene*, **23**, 522–525.
- Johnson, B.K., Gichogo, A., Gitau, G. *et al.* (1981) Recovery of O'nyong-nyong virus from *Anopheles funestus* in western Kenya. *Transactions of the Royal Society of Tropical Medicine and Hygiene*, **75**, 239–241.
- Johnson, R.E. and Peters, C.J. (1996) Alphaviruses. In *Fields Virology*, 3rd edn (eds B.N. Fields, D.M. Knipe, P.M. Howley *et al.*), pp 843–898. Lippincott-Raven, Philadelphia.
- Jupp, P.G., Blackburn, N.K., Thompson, D.L. *et al.* (1986) Sindbis and West Nile infections in the Witwatersrand-Pretoria region. *South African Medical Journal*, **70**, 218–220.
- Kanamitsu, M., Taniguchi, K., Urasawa, S. *et al.* (1979) Geographic distribution of arbovirus antibodies in indigenous human populations in the Indo-Australian archipelago. *American Journal of Tropical Medicine and Hygiene*, **28**, 351–363.
- Katz, I.A., Hale, G.E., Hudson, B.J. *et al.* (1997) Glomerulonephritis secondary to Barmah Forest virus infection. *Medical Journal of Australia*, **167**, 21–23.
- Kay, B.H. (1982) Three modes of transmission of Ross River Virus by *Aedes vigilax* (Skuse). *Australian Journal of Experi-*

- mental Biology and Medical Science, **60**, 339–344.
- LeDuc, J.W., Pinheiro, F.P. and Travassos da Rosa, A.P.A. (1981) An outbreak of Mayaro disease in Belterra, Brazil. II. Epidemiology. *American Journal of Tropical Medicine and Hygiene*, **30**, 682–688.
- Lee, E., Stocks, C., Lobigs, P. *et al.* (1997) Nucleotide sequence of the Barmah Forest virus genome. *Virology*, **227**, 509–514.
- McIntosh, B.M., McGillivray, G.M., Dickinson, D.B. *et al.* (1964) Illness caused by Sindbis and West Nile viruses in South Africa. *South African Medical Journal*, **38**, 291–294.
- Mackenzie, J.S., Lindsay, M.D., Coelen, R.J. *et al.* (1994) Arboviruses causing human disease in the Australasian zoogeographic region. *Archives of Virology*, **136**, 447–467.
- Malherbe, H. and Strickland-Cholmley, M. (1963) Sindbis virus infection in man. Report of a case with recovery of virus from skin lesions. *South African Medical Journal*, **36**, 547–552.
- Martin, D.H., Eddy, G.A., Sudia, W.D. *et al.* (1972) An epidemiologic study of Venezuelan equine encephalomyelitis in Costa Rica, 1970. *American Journal of Epidemiology*, **95**, 565–577.
- Moore, D.L., Causey, O.R., Carey, D.E. *et al.* (1975) Arthropod-borne viral infections of man in Nigeria, 1964–1970. *Annals of Tropical Medicine and Parasitology*, **69**, 49–64.
- Niklasson, B. and Vene, S. (1996) Vector-borne viral disease in Sweden: a short review. *Archives of Virology. Supplementum*, **11**, 49–55.
- Niklasson, B., Espmark, A. and Lundstrom, J. (1988) Occurrence of arthralgia and specific IgM antibodies three to four years after Ockelbo disease. *Journal of Infectious Diseases*, **157**, 832–835.
- Nimmannitya, S., Halstead, S.B., Cohen, S.N. *et al.* (1969) Dengue and chikungunya virus infection in man in Thailand 1962–1964. Observations on hospitalised patients with haemorrhagic fever. *American Journal of Tropical Medicine and Hygiene*, **18**, 954–971.
- Peters, C.J. and Dalrymple, J.M. (1990) Alphaviruses. In *Fields Virology*, 3rd edn (eds B.N. Fields, D.M. Knipe, P.M. Howley *et al.*), pp 713–759. Lippincott-Raven, Philadelphia.
- Pfeffer, M., Proebster, B., Kinney, R.M. *et al.* (1997) Genus-specific detection of alphaviruses by a semi-nested reverse transcription-polymerase chain reaction. *American Journal of Tropical Medicine and Hygiene*, **57**, 709–718.
- Phillips, D.A., Murray, J.R., Aaskov, J.G. *et al.* (1990) Clinical and subclinical Barmah Forest virus infection in Queensland. *Medical Journal of Australia*, **152**, 463–466.
- Pinheiro, F.P., Freitas, R.B., Travassos da Rosa, J.F. *et al.* (1981) An outbreak of Mayaro virus disease in Belterra, Brazil. I. Clinical and virological findings. *American Journal of Tropical Medicine and Hygiene*, **30**, 674–681.
- Poidinger, M., Roy, S., Hall, R.A. *et al.* (1997) Genetic stability among temporally and geographically diverse isolates of Barmah Forest virus. *American Journal of Tropical Medicine and Hygiene*, **57**, 230–234.
- Przelomski, M.M., O'Rourke, E., Grady, G.F. *et al.* (1988) Eastern equine encephalitis in Massachusetts: a report of 16 cases, 1970–1984. *Neurology*, **38**, 736–739.
- Rico-Hesse, R., Weaver, S.C., de Siger, J. *et al.* (1995) Emergence of a new epidemic/epizootic Venezuelan equine encephalitis virus in South America. *Proceedings of the National Academy of Sciences of the USA*, **92**, 5278–5281.
- Rodhain, F., Gonzalez, J.P., Mercier, E. *et al.* (1989) Arbovirus infections and viral haemorrhagic fevers in Uganda: a serological survey in Karamoja district, 1984. *Transactions of the Royal Society of Tropical Medicine and Hygiene*, **83**, 851–854.
- Rosen, L., Gubler, D.J. and Bennett, P.H. (1981) Epidemic polyarthritides (Ross River) virus infection in the Cook Islands. *American Journal of Tropical Medicine and Hygiene*, **30**, 1294–1302.
- Rwaguma, E.B., Lutwama, J.J., Sempala, S.D. *et al.* (1997) Emergence of epidemic O'nyong-nyong fever in south-western Uganda, after an absence of 35 years (letter). *Emerging Infectious Diseases*, **3**, 77.
- Sellner, L.N., Coelen, R.J. and Mackenzie, J.S. (1994) Sensitive detection of Ross River virus: a one tube nested RT-PCR. *Journal of Virological Methods*, **49**, 47–58.
- Shinefield, H.R. and Townsend, T.E. (1953) Transplacental transmission of Western equine encephalomyelitis. *Journal of Pediatrics*, **43**, 21–25.
- Stocks, N., Selden, S. and Cameron, S. (1997) Ross River virus infection. Diagnosis and treatment by general practitioners in South Australia. *Australian Family Physician*, **26**, 710–717.
- Strauss, E.G. and Strauss, J.H. (1986) Structure and replication of the alphavirus genome. In *The Togaviridae and Flaviviridae* (eds S. Schlesinger and M.J. Schlesinger), pp 35–90. Plenum Press, New York.
- Strauss, E.G., Rice, C.M. and Strauss, J.H. (1984) Complete nucleotide sequence of the genomic RNA of Sindbis virus. *Virology*, **133**, 92–110.
- Taylor, R.M., Hurlbut, H.S., Work, T.H. *et al.* (1955) Sindbis virus: a newly recognised arthropod-transmitted virus. *American Journal of Tropical Medicine and Hygiene*, **4**, 844–862.
- Thein, S., La-Linn, M., Aaskov, J. *et al.* (1992) Development of a simple indirect enzyme-linked immunosorbent assay for the detection of immunoglobulin M antibody in serum from patients following an outbreak of chikungunya virus infection in Yangon. *Transactions of the Royal Society of Tropical Medicine and Hygiene*, **86**, 438–442.
- Tubulekas, I., Berglund, P., Fleeton, M. *et al.* (1997) Alphavirus expression vectors and their use as recombinant vaccines: a minireview. *Gene*, **190**, 191–195.
- Voskin, M.H., McLaughlin, G.L., Day, J.F. *et al.* (1993) A rapid diagnostic assay for eastern equine encephalomyelitis viral RNA. *American Journal of Tropical Medicine and Hygiene*, **49**, 772–776.
- Wang, K.S., Kuhn, R.J., Strauss, E.G. *et al.* (1992) High-affinity laminin receptor is a receptor for Sindbis virus in mammalian cells. *Journal of Virology*, **66**, 4992–5001.
- Weaver, S.C., Salas, R., Rico-Hesse, R. *et al.* (1996) Re-emergence of epidemic Venezuelan equine encephalomyelitis in South America. VEE Study Group. *Lancet*, **348**, 436–440.
- WHO (1967) Arboviruses and human disease. *WHO Technical Report Series*. **369**.
- Williams, M.C. and Woodall, J.P. (1961) O'nyong-nyong fever: an epidemic virus disease in East Africa. II. Isolation and some properties of the virus. *Transactions of the Royal Society of Tropical Medicine and Hygiene*, **55**, 135–140.

Flaviviruses

Barry D. Schoub and Nigel K. Blackburn

University of Witwatersrand, Sandringham, South Africa

INTRODUCTION

The *Flaviviridae* are a family of viruses comprising over 70 members and are responsible for a major portion of disease and death in humans and animals. The family is subdivided into three genera: *Flavivirus*, *Pestivirus* and *Hepacivirus*.

Flavivirus

The genus *Flavivirus* was formerly termed group B arboviruses and prior to 1984 was placed together with the group A arboviruses, within the family *Togaviridae*. However, as knowledge of the flaviviruses increased, it became apparent that their features and properties such as their replication strategies, their structure and their biochemistry, were sufficiently distinctive that they would need to be placed in a separate family, the *Flaviviridae*, with the two additional genera of *Pestivirus* and *Hepatitis C virus* being added subsequently. More recently hepatitis G virus has been tentatively added to the *Flaviviridae* family although its taxonomic designation remains to be defined.

The majority of the genus *Flavivirus* are arboviruses which are transmitted between a vertebrate host and an invertebrate host (mosquitoes or ticks). Replication and amplification of virus occurs in both the vertebrate and invertebrate hosts. With some of the flaviviruses humans may be the major vertebrate host, for example dengue and urban yellow fever, and the virus is maintained by alternately

being transmitted from human to mosquito to human. In most of the flavivirus infections, the virus is maintained in nature by alternate infection of a variety of mammals or birds, or occasionally other vertebrate hosts, and their respective mosquito or tick vectors. Humans are infected as an accidental event when intruding into this natural ecosystem. In these situations they are dead-end hosts of no biological significance to the life cycle of the virus. The non-arboviruses, which are members of the genus *Flavivirus*, may be found in either arthropods or in vertebrates, but not in both, and are of little medical importance.

Whether flaviviruses have a narrow or wide host range, their distribution is dependent on the ecology of their specific vertebrate and invertebrate hosts. Some flaviviruses have very restricted geographic distributions, such as Kyasanur Forest disease found to date only in Karnataka (previously Mysore) State in India, Omsk haemorrhagic fever found in the Omsk district of western Siberia, or Rocio in the Santista lowlands and the Ribeira valley of Sao Paulo state in southeast Brazil. By contrast, flaviviruses such as West Nile are widely distributed through Africa, Asia and large parts of Europe. Japanese encephalitis is found in at least 16 countries in a wide belt stretching from eastern to southeastern to southern Asia, affecting a combined population in excess of two billion. Dengue virus has moved over the past 20 years from southeast Asia into the Pacific, the Americas, Africa and Australia, progressively establishing itself in local populations of the widespread human-biting mosquito *Aedes aegypti*.

The clinical manifestations of the majority of flavivirus infections are relatively non-specific. In endemic areas, the diagnosis of infection is often made on clinical suspicion, especially if the physician is alerted by epidemic activity in the region. Occasionally outbreaks of flavivirus infection may follow climatic events, for example, heavy rains after a period of drought, which result in the formation of numerous stagnant pools facilitating the breeding of mosquito vectors and also attracting bird life. Outbreaks may follow uncontrolled urbanization and the breakdown of vector control measures, as has occurred in recent yellow fever outbreaks in West Africa. In some situations human cases may follow an extensive zoonosis in the vertebrate host, especially where birds or livestock are involved. Surveillance and epidemiological monitoring which involve, amongst other things, the continual and sustained sampling of arthropod vectors and vertebrate hosts for arbovirus activity, is of critical importance in the prevention and management of outbreaks of flavivirus infections. Recently calls have been made for mobile units to be established and sent into the field to conduct clinical diagnosis and therapeutic research as well as for epidemiological surveillance in endemic areas.

The diagnosis of infection due to flaviviruses becomes particularly difficult in individuals who have travelled from an endemic area and present themselves for medical management many thousands of miles away from their source of infection. In the modern era of jet travel, a history of travel and a knowledge of the prevalent infections in different parts of the world are now an important component of infectious diseases medicine. In addition, travellers should be educated to alert their attending physician should they become ill on returning home.

Pestivirus

The second genus in the family *Flaviviridae*, *Pestivirus*, is also referred to as the mucosal disease virus group. The viruses of this genus are the causes of important veterinary diseases worldwide, such as bovine viral diarrhoea, border disease of sheep and hog cholera. They are not known to be spread by arthropod vectors, transmission taking place by direct contact and also via faeces, urine and nasal

secretions, as well as vertically. The pestiviruses are not able to infect humans.

Hepacivirus

The third, and newest genus of the family *Flaviviridae*, is *Hepacivirus*, which is described in detail in Chapter 3. The biochemical and biophysical characteristics of the virus have been determined and have been shown to be characteristic of the family *Flaviviridae*. *Hepatitis C virus* (HCV) is not an arbovirus and is not known to infect any non-human host in nature. Experimentally the only animal able to be infected is the chimpanzee. Infection is transmitted by blood transfusion, penetrating injuries with blood-contaminated needles and instruments, sexually, and from mother to child during birth. Since the implementation of widespread screening for *Hepatitis B virus* (HBV) in blood, HCV has become the major cause of post-transfusion hepatitis. Current screening programmes for hepatitis C have, in turn, significantly reduced the incidence of post-transfusion hepatitis due to this virus.

The most recent member of the family *Flaviviridae* is *Hepatitis G virus* (HGV). The virus was first detected in 1995 in laboratory tamarins experimentally inoculated with blood from a surgeon with clinical hepatitis. Three distinct agents were defined and called GBV-A, GBV-B and GBV-C although it appeared that only GBV-C was a human virus (GBV-A and GBV-B were probably tamarin agents). HGV was described at approximately the same time by a different laboratory but subsequent analysis of HGV and GBV-C has suggested that they are identical viruses. Both are, however, distinct from HCV, having only 29% amino acid homology with it. The pathological role, if any, of GBV-C or HGV has not yet been established. The virus is discussed more fully in Chapter 3.

PROPERTIES OF THE VIRUS

The type species of the genus *Flavivirus*, *Yellow fever virus*, has been the most extensively studied member of the family.

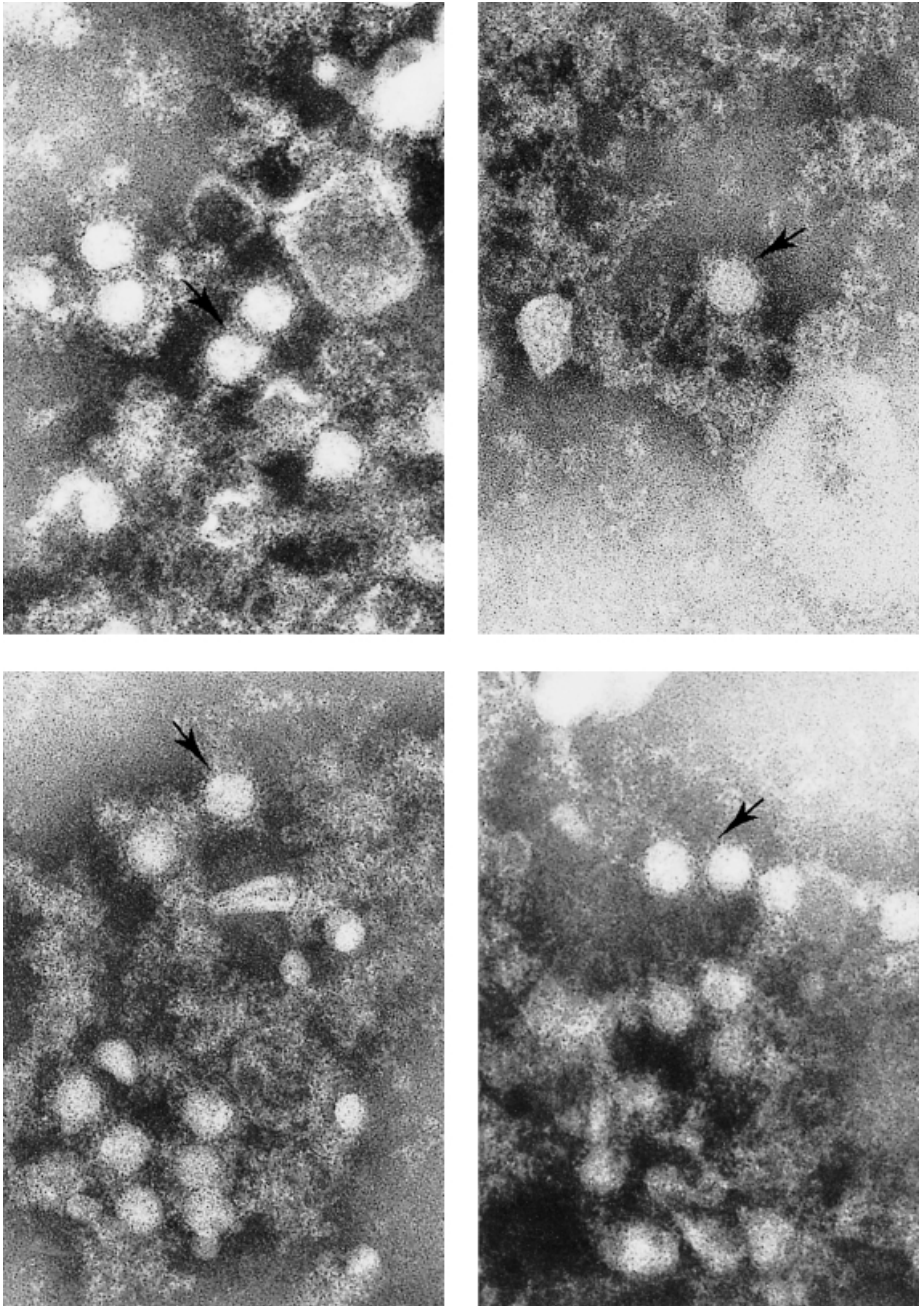

Figure 17.1 Electron micrograph of negatively stained spherical West Nile virus particles. The envelope is tightly applied to the nucleocapsid with peplomers clearly visible in many particles (arrows). ($\times 117000$.) (Professor G. Lecatsas, Department of Virology, Medunsa University, South Africa)

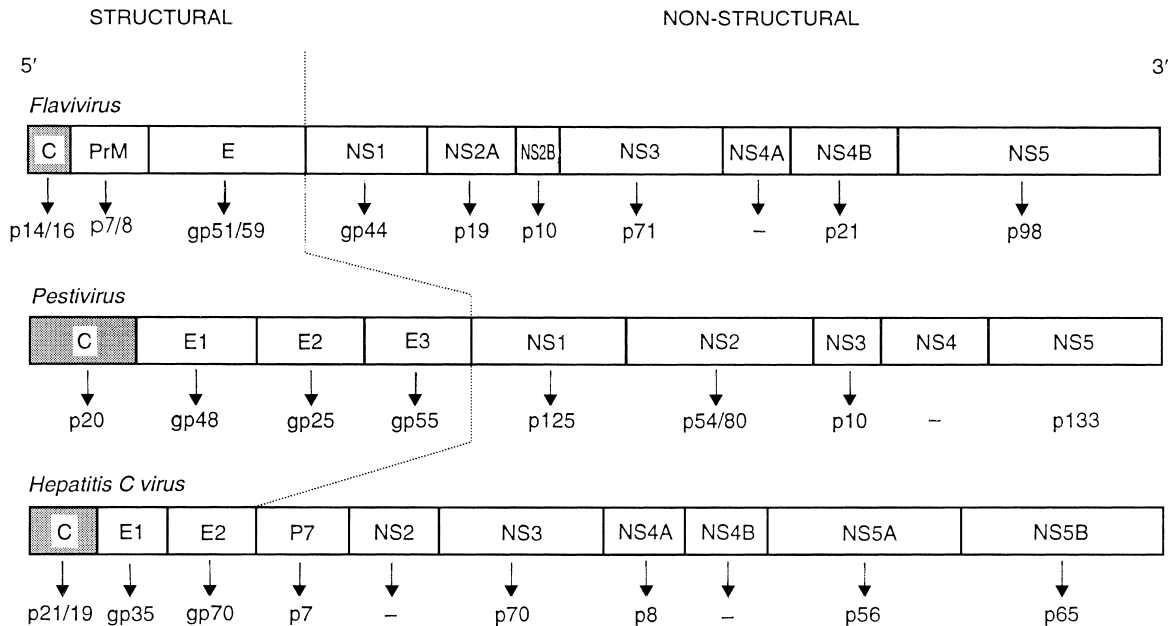

Figure 17.2 Organization of the genes of *Flavivirus*, *Pestivirus* (tentative) and *Hepatitis C virus* (tentative)

Morphology and Morphogenesis (Figure 17.1)

Virus particles are spherical with a diameter of some 40–50 nm. The envelope is tightly applied to a 25–30 nm spherical core and surface peplomers are often visible. Replication of virus takes place in the cytoplasm of the cell in association with the rough and smooth endoplasmic reticulum. Accumulation of viral particles are seen within lamellae and vesicles and replication is characteristically associated with the proliferation of intracellular membranes.

Hepatitis C particles produced in MT-2 (transformed T cell line) have been visualized by electron microscopy and appear as particles of 60–70 nm size with an envelope embedded in which are prominent glycoprotein spikes 6–8 nm in length.

Biophysical and Biochemical Properties

The S_{20W} of flaviviruses is 170–210, that of pestiviruses is 140 and that of hepaciviruses is ≥ 150 . The buoyant density of the flaviviruses in CsCl is

1.22–1.24 g ml⁻¹ and 1.15–1.20 g ml⁻¹ in sucrose; that of pestivirus is 1.12–1.13 g ml⁻¹ in sucrose and that of hepaciviruses is 1.09–1.11 g ml⁻¹ in sucrose.

Flaviviruses

The nucleic acid of flaviviruses consists of a single molecule of positive-sense single-stranded (ss) RNA. A single open reading frame (ORF) on the genomic RNA is translated directly into a poly-protein which is further processed into the three structural proteins. These are, in order from the N terminal, the internal RNA associated C protein and then the two envelope proteins, pre-M and E. The pre-M protein is a glycosylated precursor protein which is cleaved during or shortly after release from the cell into the non-glycosylated M membrane protein with no disulphide bridges (molecular weight 7–9 kDa). The E membrane protein is usually glycosylated, and is considerably larger, with a molecular weight of 51–59 kDa and possessing six disulphide bridges formed by 12 conserved cysteine residues. The core protein C is rich in arginine and lysine with a molecular weight of 14–16 kDa.

Following the translation of the three structural proteins, seven non-structural proteins are produced - the glycoproteins NS1, NS2A, NS2B, NS3, NS4A, NS4B and NS5. Two of these proteins, NS3 and NS5, are probably components of the RNA replicase. The gene order is thus 5' - C - pre-M - E - NS1 - NS2A - NS2B - NS3 - NS4A - NS4B - NS5 - 3' (Figure 17.2).

The lipid content of the flavivirus envelope, which comprises some 17% of the viral weight, is derived from the host cell membrane. The E and M proteins are inserted into the envelope. The glycoprotein E is rich in mannose and complex glycans.

Pestiviruses

Considerably less is known about the molecular biology of the genus *Pestivirus*. It does, however, follow the same general molecular features and replication strategies as in the case of *Flavivirus*. There is, similarly, a large ORF which directly translates a single polyprotein of approximately 4000 amino acids. The definition of the structural proteins of the virus has not, as yet, been established. Three viral glycoproteins are produced (molecular weight is 53–57, 44–48 and 23–31 kDa, respectively). These are probably envelope proteins and antibodies to the 55–57 glycoprotein neutralize virus infectivity. In addition, there is a core protein, which is probably the first polypeptide (from the amino terminal) of the polyprotein (molecular weight 20–31 kDa). The lipid composition of the virus has not been reported. The tentative gene order established by sequence specific antibody reactivities is 5' - p20 - gp48 - gp45 - gp55 - p125 - (p54/p80) - p10 - X (not yet identified) - p133 (p58/p75) - 3' (Figure 17.2).

Hepaciviruses

Studies of nucleotide sequences of cloned HCV have revealed a genome of somewhat smaller size (molecular weight 3.5×10^6) to the other genera of the *Flaviviridae* family. Comparative sequence studies have shown a close relationship with both pestiviruses and flaviviruses. The single ORF directly translates a polyprotein of between 3008 and 3037 amino acids depending on the genotype of the virus.

Flanking the ORF are long untranslated regions (UTRs) on the 5' and 3' ends of the genome. Cap-independent translation of the polyprotein is in-

itiated at the internal ribosomal entry site (IRES), as has been demonstrated with the pestiviruses and also in the picornaviruses. The polyprotein is then processed by both host and viral proteinases into at least 10 distinct viral proteins. The structural proteins occupy the amino-terminal third and the replicated enzymes the carboxy-terminal two-thirds. The structural proteins are comprised of the highly basic core protein (C) and two glycoproteins E1 and E2. The core protein is probably the capsid of the virus. Two main core proteins have been detected *in vivo* and *in vitro*, p21 the full length protein and p19 a secondary cleavage product. The heavily glycosylated E1 (gp35) and E2 (gp70) are the major structural proteins forming a complex which is predominantly non-covalently associated. E2 is the most variable region of the genome and antibodies directed against it have been demonstrated to mediate protection in chimpanzee studies. Multiple species of E2 are found, caused by variable extensions at its carboxy-terminus with a smaller protein, p7, which is situated adjacent to it on the genome. The NS2 protein appears next; its function is as yet unclear. The 70 kDa NS3 protein functions as a viral protease and is responsible for the proteolytic processing of the downstream remainder of the viral polyprotein (the structural protein portion of the polyprotein is cleaved by host enzymes). In addition, NS3 may also have NTPase and RNA helicase enzymatic functions and may also have a role in the pathogenesis of some diseases, for example it has been shown to transform cells *in vitro*. The small NS4A (8 kDa) protein serves a variety of functions such as anchorage of replication complexes and is a cofactor for the NS3 protease; the function of the NS4B is not yet known. The NS5A (p56) and NS5B (p65) proteins probably play a role in the replication cycle and, in addition, the highly phosphorylated NS5A may be a crucial determinant of the susceptibility of the virus to interferon.

Molecular studies of HCV isolates have revealed significant differences in genomic and polypeptide length and a considerable diversity of about 30% in nucleotide sequences, suggesting a quasispecies distribution of virus isolates. At least six genotypes and over 30 subtypes have been identified throughout the world. Genotypic identification is not only of significance for charting the molecular epidemiology of the virus but is also of clinical diagnostic value as certain genotypes appear to be virulent or may display different sensitivities to antiviral treat-

ment, especially interferon (Smith *et al.*, 1997).

each genus are antigenically related to each other, but there is little cross-reactivity between the three genera.

ANTIGENIC PROPERTIES

The antigenic properties of the genus *Flavivirus* are defined by serological tests such as the highly cross-reactive pH-dependent haemagglutination-inhibition (HI) test, the less cross-reactive complement fixation (CF) test and the much more specific neutralization (NT) or plaque reduction neutralization (PRNT) test. Other techniques mainly used for diagnostic serology are IgG and IgM detection by enzyme-linked immunoassay (ELISA) and immunofluorescent (IF) assays. The antigenic features of the virus are characterized by reactivity with antigenic domains and epitopes on the membrane E protein of the virus.

The genus *Flavivirus* is further subdivided into subgroups on the basis of cross-neutralization tests using a polyclonal hyperimmune mouse ascitic fluid prepared against each member virus. The members of each subgroup give significant cross-neutralization results against each other, whereas the 'unsigned' subgroup contains a miscellany of flaviviruses which will display only limited cross-reactivity with each other or with at least one other virus in any of the established subgroups. The antigenic classification of members of the genus *Flavivirus* of medical importance, together with their respective vectors, disease manifestations, geographic distribution, vaccine availability and frequency of reported cases, is given in Table 17.1. The flaviviruses which either cause no human disease, or have only rarely been reported in association with illness, will not be dealt with further. The genus *Pestivirus*, which does not cause human disease, will also not be discussed further. HCV and HGV are dealt with fully in Chapter 3.

The genus *Pestivirus* does not show haemagglutinating activity but cytopathic strains can be identified by NT or PRNT techniques. Many of the virus isolates belonging to this genus propagate in host species cells but do not cause cytopathic effect. These may be typed using IF techniques. Serosurveys or diagnostic serology can be carried out using ELISA tests or NT with a cytopathic strain as the indicator virus. Serological tests for HCV are confined to immunoassays, either enzyme-linked or radioimmunoassays. The member viruses within

YELLOW FEVER

The *Yellow fever virus* is the type species of the genus *Flavivirus* and also the source of its name (flavus is Latin for yellow). Yellow fever has been one of the classic diseases of antiquity, instilling dread and terror in the Americas, Europe and Africa from the seventeenth to the twentieth century. The disease has been romanticized in the classic works of Samuel Coleridge Taylor's *Rime of the Ancient Mariner* and the Wagnerian opera *The Flying Dutchman*. At the beginning of the twentieth century the disease almost put paid to the construction of the Panama Canal, and in West Africa yellow fever more than any other disease was responsible for the appellation of 'the white man's grave'. As late as 1988, an estimated 44 000 cases with 25 000 deaths were estimated to have occurred in Nigeria in the 3 years 1986–1988.

History

The disease entity of yellow fever was first described in 1667 in Barbados, and in the following two centuries devastating epidemics raged on the continents of America and Africa and also, to some extent, in Europe. The panic and chaos was matched by the extravagance of the speculations as to the cause. The confusion was further aggravated by the difficulty in distinguishing it from the other tropical plagues of malaria and dengue. In 1848, Nott proposed that yellow fever was transmitted by the bite of a mosquito, a suggestion supported by Beaupertuy in 1854 and Carlos Finlay in 1881. In 1900 the US Army Yellow Fever Commission, under Major Walter Reed, demonstrated in historical experiments on human volunteers that the infection was indeed transmitted by mosquitoes. The following year, Walter Reed demonstrated that yellow fever was due to a filterable agent, the first human disease shown to be due to a filterable agent. The discovery of the aetiological agent of yellow fever, however, had to wait a further 26 years when workers of the Rockefeller Foundation's West Africa Yellow Fever

Table 17.1 Antigenic classification of flaviviruses of medical importance and their clinical and epidemiological features in humans

Subgroup	Virus	Vector	Disease manifestations	Geographic distribution	Vaccine	Frequency of reported cases ^b	
Unassigned	Yellow fever	M	Fever, HF, jaundice, etc.	Tropical Africa and S. America	Yes	Numerous	
	Rocio	M	Encephalitis	S.E. Brazil	No	Uncommon	
	Bussuquara ^a	M	Fever, arthralgia	S. America	No	Rare	
	Ilheus ^a	M	Fever, encephalitis	S. America Trinidad	No	Rare	
	Sepik ^a	M	Fever	New Guinea	No	Rare	
	Spondweni ^a	M	Fever	Africa	No	Rare	
	Wesselsbron	M	Fever	Africa, Thailand	No	Uncommon	
	Zika ^a	M	Fever, rash	Africa, Malaysia	No	Rare	
	Dengue	Dengue types 1–4	M	Fever, rash, myalgia, HF	Asia, Pacific, Americas, Africa	No	Numerous
	Japanese encephalitis, mosquito-borne encephalitis	Japanese encephalitis	M	Encephalitis	East Asia	Yes	Numerous
St Louis encephalitis		M	Encephalitis	N. America, Jamaica, Haiti, S. America	No	Numerous	
West Nile		M	Fever, rash, encephalitis rare	Africa, Asia, Europe	No	Numerous	
Murray Valley encephalitis		M	Encephalitis	Australia, New Guinea	No	Uncommon	
Kokobera ^a		M	Arthritis	Australia	No	Rare	
Kunjjin ^a		M	Fever, encephalitis	Australia, Borneo, Indonesia, Malaysia	No	Rare	
Usutu ^a		M	Fever, rash	Africa	No	Rare	
Tick-borne encephalitis		TBE—European subtype (CEE)	T	Encephalitis	Central and western Europe	Yes	Numerous
		TBE—Far Eastern subtype (RSSE)	T	Encephalitis	Asiatic Russia	Developmental	Numerous
		Omsk HF	T	Fever, HF	Western Siberia	CEE?	Numerous
	Kyasanur forest disease	T	Fever encephalitis	Kanataka State, India	Yes	Uncommon	
	Powassan	T	Encephalitis	N. America	No	Uncommon	
	Louping ill ^a	T	Encephalitis	UK	No	Rare	
	Negishi ^a	?	Encephalitis	Japan, Russia	No	Rare	
	Kumlinge ^a	T	Encephalitis	Australasia	No	Rare	
	Rio Bravo	Rio Bravo ^a	?	Fever	USA, Mexico	No	Rare
		Dakar Bat ^a	?	Fever	Africa	No	Rare
Uganda S	Uganda S ^a	M		Africa ? Far East	No	Rare	
	Banzi ^a	M	Fever	Africa	No	Rare	

^a These viruses are of very little importance to clinical medicine and will not be discussed further.

^b Numerous = > 1000 cases reported, usually many thousands to millions; uncommon = 10–1000 cases reported; rare = < 10 cases reported. M = Mosquito; T = Tick; HF = Haemorrhagic fever; TBE = Tick-borne encephalitis; CEE = Central European encephalitis; RSSE = Russian spring–summer encephalitis.



Figure 17.3 Geographic distribution of *Yellow fever virus*

Commission demonstrated the transmission of infection from a Ghanaian patient called Asibi, to a rhesus monkey, and the subsequent passing between monkeys. The Asibi strain was later to be the parent strain of the 17D vaccine developed by Nobel laureate Max Theiler at the Rockefeller Foundation in New York in 1937. The 17D vaccine strain was developed by serial passage through mouse embryo culture to chick embryo culture and then through minced chick embryo devoid of nervous tissue. The final vaccine virus propagated through fertilized chicken eggs is remarkably attenuated yet immunogenic, and the vaccine has proved to be very safe and effective, probably producing lifelong immunity after a single injection.

Epidemiology

Yellow fever occurs today in the tropics on both sides of the Atlantic (Figure 17.3). The endemic zone in the Americas stretches between the latitudes of 10°N and 40°S and in Africa from 16°N to 10°S.

In the Americas, effective control of *Ae. aegypti* has resulted in the virtual disappearance of urban yellow fever from the western hemisphere. The last such epidemic of urban yellow fever occurred in Trinidad in 1954. However, jungle fever remains endemic in Bolivia, Brazil, Columbia, Ecuador, Peru, Panama, Venezuela and the Guianas. The annual incidence by notification is 100 cases, although this is probably a substantially underestimated number. Remarkably, the infection has not extended to the heavy concentrations of *Ae. aegypti* which have built up in urban centres.

In Africa, recent epidemics of yellow fever have been far more extensive than those in the Americas.

The features of jungle yellow fever differ in East and West Africa. In East Africa, endemic yellow fever activity is relatively quiet, with few notified cases. However, two vast epidemics took place in 1940 in the Nuba mountains of Sudan, causing 40 000 infections with over 15 000 clinical cases and 1 500 deaths. The second epidemic in 1960–1962, the largest epidemic of yellow fever ever recorded, took place in southwest Ethiopia, causing 30 000 deaths in 100 000 clinical cases in a rural population of some 1 million. In contrast to this, in West Africa frequent outbreaks have occurred, usually on a considerably smaller scale to the two East African epidemics, with the exception of the Nigerian epidemic of 1986–1988, when an estimated 44 000 cases and 25 000 deaths may have occurred (WHO, 1991). Over the last decade significant epidemics have been reported from several West African countries, both preceding the Nigerian epidemic, in the Ivory Coast (1982) and Burkina Faso (1983), as well as after it, in Mali (1987), Angola (1988), Cameroon (1990) and Niger (1990). Yellow fever has expanded into Gabon, Liberia and Kenya, countries which reported their first cases since 1950 between 1992 and 1995 (World Health Organization, 1996a).

The transmission cycles of yellow fever and the ecological interrelationships of its vectors and reservoir hosts are complex. Essentially three cycles of transmission are recognized:

1. The *enzootic forest cycle* represents the predominant maintenance of infection in its major vertebrate host, the monkey. In South America, *Alouatta*, *Cebus* and *Ateles* monkeys are the major primate reservoir hosts and they are infected by tree-hole breeding *Haemagogus* mosquitoes in the forest canopy. The monkey is, however, only a transient host because of the short-lived viraemia. The major amplification host is the mosquito, which remains infected for life and is also able to pass infection on transovarially. Occasionally a single or a few human cases may occur when humans ventures into the forests. The cycle in Africa is similar and involves *Cercopithecus* and *Colobus* monkeys and the *Ae. africanus* mosquito as the principal vector.
2. The *jungle yellow fever cycle* represents the most important epidemiological form of yellow fever with respect to human infection. Epizootic upsurges of yellow fever are frequent, both on the fringes of the rain forests as well as in the sur-

rounding riverine gallery forests. Human infection occurs when forest mosquitoes invade adjacent plantations, clearings and villages. Once infection has been introduced into the human host, human-to-human transmission sustains the epidemics, resulting in the dramatic outbreaks reported in recent years. In South America, *Haemagogus* mosquitoes and possibly other mosquito species may establish epidemics in humans. In East and Central Africa east of Cameroon, *Ae. simpsoni* will readily bite monkeys and humans. In the East African epidemics in Sudan and Ethiopia, the anthropophilic *Ae. Aegypti* was the most frequently responsible mosquito, as well as a number of 'wild' mosquitoes. In West Africa and Central Africa west of Cameroon, *Ae. simpsoni* does not bite humans and *Ae. furcifer* is the major vector. In the Nigerian epidemic the major vector was *Ae. africanus*.

3. The *urban yellow fever cycle* is maintained by *Ae. aegypti* and was the dominant form of yellow fever before extensive mosquito control eliminated the disease from South American towns. Periodic reinfestations with *Ae. aegypti* have been observed in many South American countries and have revived fears of a resurgence of urban yellow fever. In West Africa *Ae. aegypti*-transmitted yellow fever is still responsible for outbreaks in towns and rural villages.

Clinical Features

The clinical presentation of yellow fever follows the general pattern of arbovirus disease – a short incubation period of 3–6 days followed by an acute biphasic illness. It is the severity and extent of the second phase of the acute illness which has imparted to this infection its classical awesomeness.

The initial phase of illness is characterized by a viraemia which renders the patient infectious to biting mosquitoes and is also responsible for the acute constitutional symptoms. These symptoms last about 3 days and are generally those of a non-specific febrile illness: headache, malaise, nausea, lassitude and widespread muscle pain, especially in the back. The differential diagnosis is wide and includes malaria, other arbovirus infections including dengue, typhoid, rickettsial infections, influenza, enterovirus infections, acute HIV infection, etc.

With more intensive and careful physical examination of patients, signs and symptoms more suggestive of yellow fever may be revealed, such as flushing of the head and neck, conjunctival injection, strawberry tongue and a relative bradycardia. Probably the majority of clinically manifest yellow fever infections are aborted at this phase of the illness, accounting for the underestimating of the true numbers of cases by up to 500-fold (WHO, 1991).

In cases of severe yellow fever, the early acute illness is followed by a brief period of remission before the onset of the haemorrhagic, hepatic and renal disease. The latter is heralded by a return of fever, vomiting, abdominal pain, dehydration and prostration. The onset of the haemorrhagic diathesis is usually marked by coffee-ground haematemesis, the classical 'black vomit', and bleeding from puncture sites where injections or drip needles have been inserted. This is accompanied by jaundice, albuminuria and oliguria. Deepening jaundice, massive haematemesis or haemoptysis or intra-abdominal bleeding, progressive renal failure, hypotension and shock may occur, followed by stupor, coma and death by the 7th to 10th day. Occasionally the illness may run a rapid fulminant course with death within a few days of onset. Mortality has been estimated to be of the order of 20–50% of cases entering the second phase of illness, although case fatality rates of up to 83% have been reported (WHO, 1990). These figures probably represent a marked overestimate of the fatality rate in the more severe cases which are likely to come to the attention of the health authorities. The differential diagnosis of severe yellow fever is usually that of the causes of viral haemorrhagic fever: Congo Crimean haemorrhagic fever, Rift Valley fever, meningococcal septicaemia, Marburg and Ebola, generalized herpes simplex as well as HBV infection, leptospirosis and toxic hepatitis. During the severe second phase of illness, virus is usually absent from the blood and antibodies are present, suggesting that autoimmunity may well play a major role in the pathogenesis of severe yellow fever.

Patients who survive generally recover completely, although a chronic phase of illness lasting weeks or sometimes even months may occur in some individuals. This is characterized by prolonged jaundice and disturbances of liver function, as well as prolonged renal failure. Occasionally sudden death may occur in the chronic phase as the result of myocardial damage or cardiac arrhythmias.

A number of host factors may affect the clinical expression and severity of yellow fever virus infection. Age has played a significant role in South American epidemics, the majority of infections occurring in young adults, especially between the ages of 20–25. Age distribution has not, however, been a significant characteristic of African epidemics. In some epidemics gender has played a significant role in the distribution of cases. For example, in the 1972–1973 Brazil epidemic there was a marked predominance (90%) of males affected, whereas in others there was only a slight male preponderance (e.g. 53% males in the 1986 Nigerian epidemic). More controversial has been the purported association of race and susceptibility to yellow fever, especially in the classical literature, which frequently made reference to the mildness of the disease in the indigenous inhabitants of the African jungle. There is, however, no evidence confirming any difference in susceptibility between races.

There are no known viral factors affecting either transmissibility or virulence. Although genomic heterogeneity has been demonstrated by fingerprinting and sequencing studies, and some antigenic heterogeneity has been observed between isolates, there has been no demonstrable clinical or epidemiological differences between American and African isolates.

Diagnosis

The development of reliable rapid tests for the urgent diagnosis of yellow fever has become a major public health priority in the management of the viral haemorrhagic fevers. The IgM antibody capture ELISA has become the test of choice for rapid serological diagnosis of yellow fever virus infection. Cross-reactions may occur but IgM antibody levels will normally be higher against yellow fever. Immunofluorescence tests using infected cells spotted on to microscope slides and then acetone fixed can be used for detecting IgG and IgM in patients' sera. In the IF test, however, the rheumatoid factor may be a much greater problem than in the IgM antibody capture ELISA and pretreatment to remove IgG prior to IgM testing is necessary. The classical techniques such as HI, CF and NT still have a place in yellow fever surveillance and diagnosis but a fourfold or greater rise in titre would have to be

demonstrated before a definitive diagnosis could be made. Specific diagnosis still may be difficult, particularly if the patient has had previous experience of flavivirus infection. In these instances higher titres may appear against heterologous viruses, in keeping with the doctrine of original antigenic sin.

Isolation of virus may be performed in specialized reference laboratories, either by intracerebral or intraperitoneal inoculation of suckling mice or by the intrathoracic inoculation of male *Ae. aegypti* or *Toxorhynchites* mosquitoes. These techniques are particularly sensitive and are essential for epidemiological monitoring and research, but unfortunately take up to 3 weeks to provide an answer. More rapid viral isolation techniques using mosquito cell lines such as the lines from *Ae. albopictus* (C6-36) and *Ae. pseudoscutellaris* (MOS 61), which are sensitive to infection, combined with the IF test using monoclonal antibodies may give a diagnosis within 3–4 days. It is recommended that early antibody is dissociated from viral antigen using dithiothreitol prior to isolation attempts in mosquito cell cultures. An antigen capture ELISA technique has been developed which is slightly less sensitive than virus isolation but is able to produce a specific result with the use of monoclonal antibodies in less than 24 hours.

Liver biopsy is contraindicated in acute yellow fever. However, liver tissue from postmortem examinations may provide useful histopathological information. The classical liver pathology is that of a coagulative midzonal necrosis. The inclusion bodies which have been held to be pathognomonic of yellow fever are those in the cytoplasm due to eosinophilic degeneration (Councilman bodies) and intranuclear eosinophilic inclusion bodies (Torres bodies). Many of these features are, however, also found in fatal cases of viral haemorrhagic fever due to other viruses, and the histopathology is now no longer regarded as being diagnostic of yellow fever.

Control

The worldwide control of yellow fever has been achieved by immunization and by effective vector control, which have largely eliminated the urban yellow fever cycle due to *Ae. aegypti*. However, in recent times, poverty, war and competing health priorities have led to a reduction in immunization

and surveillance efforts, resulting in a resurgence of disease, especially in the endemic zone of Africa. In addition, reinfestation of towns and villages adjacent to forests with *Ae. aegypti*, aggravated by the massive uncontrolled urbanization and population migrations to the towns of developing countries, also exacerbated particularly by the severe drought, has renewed the spectre of urban yellow fever in Africa.

It is over 50 years since the development of the first yellow fever vaccine by Theiler, and the original method for the production of chick embryo-passaged 17D vaccine has undergone little modification over the years. The French neurotropic vaccine developed by passage in mouse brain is now no longer used because of the prohibitive danger of encephalitic complications. The vaccine is a live attenuated purified product produced by growing vaccine virus in chick embryos and is supplied as a lyophilized preparation, which should be stored frozen or at least kept at temperatures of not more than 5°C. After reconstitution it should be used immediately and any remnants discarded within an hour. A single dose of 0.5 ml given subcutaneously provides excellent, long-lasting immunity to 99% of vaccinees. Although international health regulations demand booster doses every 10 years, neutralizing antibodies have been shown to persist for over 30 years and immunity is probably lifelong.

Side-effects to immunization occur in less than 5% of recipients and are generally mild, low-grade fever, myalgia and headache. Occasionally hypersensitivity reactions have been reported, especially in individuals allergic to egg protein. The most serious side reaction, encephalitis, has been reported in 18 cases out of more than 35 million doses of vaccine which have been administered to date. Only two cases have occurred in children over the age of 7 months, although the only fatality was in a 3-year-old child. Regarding the latter case, it was recently postulated that a change identified in amino acid position 303 of the isolate P-16065 as compared to the parent vaccine virus 17D-204 USA may have affected the virulence of the vaccine virus (Jennings *et al.*, 1994).

The contraindications to immunization are those determined by age, pregnancy, history of egg allergy and immunosuppression (Centers for Disease Control, 1990). The vaccine should not be given to children under the age of 9 months unless travel to an endemic area cannot be avoided, but should, at

any rate, never be given to infants less than 4 months of age. The effect of immunization in pregnancy has not been determined, however, being a live attenuated vaccine, it should not routinely be given to pregnant women, but if travel to an area with ongoing yellow fever cannot be avoided, the danger of infection would far outweigh the theoretical risk to a pregnant mother and her fetus. The vaccine should also be avoided in persons with a history of egg allergy or in immunosuppressed individuals, for example, due to HIV infection, malignancy or individuals on immunosuppressive treatment. However, as in the case of pregnancy, the relative risks of travel to an endemic area versus the slight or even theoretical risk of the vaccine would need to be evaluated on an individual basis.

Immunization policies with regard to yellow fever immunization involve three aspects of the control of infection:-

1. *International travellers* going to yellow fever endemic areas require prophylactic immunization as a condition of entry to these countries, or exiting from endemic countries. There were two reports in 1996–1997 of travellers to the Amazon region of Brazil who died from yellow fever after returning to their respective countries. Neither had been vaccinated.
2. *Within endemic zones*, two kinds of immunization policy have been practised. These are the so-called ‘fire-fighting’ policy, where there is a response to an outbreak, or alternately proactive routine immunization to prevent outbreaks occurring. ‘Fire-fighting’ mass immunization is usually put into operation in the early phases of an outbreak or in advance of an imminent epidemic, if effective surveillance is able to predict it. Although this strategy may be cheaper than routine immunization, it can often only be implemented after a considerable number of individuals have already been infected, and the protective effect will be further delayed by another 7 days while antibodies develop. A far more effective way of controlling yellow fever is proactive, routine and sustained administration of vaccine. In Africa, 33 countries have been identified by the World Health Organization as endemic high-risk regions where yellow fever vaccine should be incorporated into the Expanded Programme on Immunization (EPI) schedule. However, only one of these countries,

Gambia, has exceeded the target vaccine coverage of 80% (87% in 1994). In other countries coverage has ranged from 1% in Nigeria to 55% in Mauritania (World Health Organization, 1996b). Yellow fever vaccine should preferably be given together with measles vaccine at 9 months of age and can be administered simultaneously with measles vaccine with no reduction in efficacy of either vaccine. It can also be given simultaneously with other viral vaccines and also BCG, with no increase in reactivity or decrease in efficacy. (However, yellow fever and cholera vaccines should preferably be separated by an interval of 3 weeks.)

The current worldwide production of yellow fever vaccine is estimated to be of the order of 15 million doses per annum. There are concerted efforts to improve on techniques for the production of yellow fever vaccine, for example by the use of tissue culture techniques and also the development of recombinant technology with reference to yellow fever immunization (Shiu *et al.*, 1991).

Vector control strategies, such as aerial spraying, domiciliary spraying and the enforcement of public health regulations to reduce collections of stagnant water and other breeding sites, have had successes in the past in eliminating *Ae. aegypti* and controlling urban yellow fever. Present-day socioeconomic difficulties have, however, hampered recent efforts to again control the reinfestation of villages and towns in Africa. Control of vectors responsible for the jungle yellow fever cycle is impractical.

There still remain many gaps in our knowledge of the epidemiology of the infection and the permanent control of the disease will probably need not only resources to implement what is already known but also the elucidation of the remaining enigmas regarding the infection.

OTHER MEMBERS OF THE 'UNASSIGNED' SUBGROUP OF FLAVIVIRUSES

Rocio

Rocio virus is an arboviral cause of encephalitis localized to the Ribeira valley and Santista lowlands in the southern coastal region of Sao Paulo state in southeastern Brazil. The virus was first

isolated in 1975 from the brain of a fatal case of encephalitis diagnosed during an unusual epidemic of encephalitis which lasted from 1975 to 1976. No further cases have occurred since 1980, although two children from the Ribeira valley tested positive for IgM antibodies in 1989. A total of 821 cases were diagnosed between 1975 and 1978, twice as many in males and usually between 15 and 30 years of age. Workers in contact with the forests and rivers were at highest risk. The virus has been isolated from pools of mosquitoes such as *Psorophora ferox* and also from wild birds. The transmission cycle of the virus has, however, not been established.

Clinical and epidemiological features of the disease in 821 cases between 1975 and 1978 have been reviewed (Iversson, 1980). The disease commences with non-specific signs of pyrexia, headache and vomiting. This may then be followed by disturbances of consciousness and signs of encephalitis, including localizing signs. Death may follow a prolonged coma or there may be a sudden fulminant course. Serious neurological sequelae occur in some 20% of clinical cases and the overall case fatality is found to be 10%. The IgM capture ELISA has been used to diagnose Rocio virus infection in children and is preferable to the HI test for identifying recent infection.

Wesselsbron

Wesselsbron virus was first isolated from a lamb in the village of Wesselsbron in South Africa in 1955. Virus has been isolated from 23 cases of infection, 11 of them resulting from laboratory infection or infection of laboratory field workers. The vertebrate host is chiefly livestock, especially sheep, and isolations have been made throughout sub-Saharan Africa, especially South Africa. It has also been isolated from pools of wild-caught *Aedes* mosquitoes such as *Ae. (Neo) lineatopennis*. The major vector in sheep is *Ae. caballus-juppi*. Human are infected by mosquito bite or by direct contact in handling carcasses or tissues of animals that have died of the disease.

Human infection is characterized by a sudden onset of pyrexia, severe headache and retro-orbital pain associated with photophobia, and hyperaesthesia of the skin with an evanescent skin rash is frequently present. Muscle and joint pains are also

commonly seen. In severe cases signs of encephalitis such as blurred vision and some mental impairment may occur. Patients recover after a few days to a week and no permanent sequelae have been reported.

Diagnosis of infection may be achieved by isolation of the virus from blood or serological tests. The HI test is only useful in individuals with no previous flavivirus infection history because of the extensive cross-reaction between Wesselsbron and other flaviviruses. The capture IgM assay is the best choice for diagnosis of recent Wesselsbron infection.

DENGUE

Dengue is, at present, the most important arboviral cause of death and disease in humans (Gubler and Costa-Valez, 1991). The infection has spread widely from southeast Asia to the Americas, the Pacific and Africa, now involving several million people annually (Figure 17.4). In all major tropical areas of the world the incidence of dengue fever (DF) and dengue haemorrhagic fever (DHF)/dengue shock syndrome (DSS) has increased dramatically over the past few years, with an ever-increasing frequency and extent of epidemics and a greater severity of cases. The spectre of the introduction of infection to *Ae. aegypti* populations in non-endemic countries is of great international concern.

History

Outbreaks of illnesses clinically resembling DF have been recorded since 1779 and 1780 in Java (Indonesia), in Cairo and in Philadelphia. Similar epidemics of dengue-like illnesses occurred at 10–30 year intervals throughout tropical and subtropical regions of the world. Although the precise aetiology could not be established and infections such as chikungunya are clinically and epidemiologically very similar, the majority of these epidemics were probably dengue. The spread of the disease has been markedly accelerated by the advent of widespread air travel over the last three decades. Dengue fever was generally regarded as a relatively benign illness, affecting predominantly colonial expatriates living in tropical countries and, although respon-



Figure 17.4 Geographic distribution of *Dengue virus*

sible for severe and often incapacitating muscle pain, it was seldom lethal. However, the gravity of the dengue pandemic was really confirmed by the recognition in the 1950s of the severe complications of infection—namely DHF/DSS affecting mainly children in the endemic areas. Epidemics of DHF/DSS ravaged southeast Asia and in the following 30 years was responsible for over 700 000 children being hospitalized and over 20 000 fatalities (Halstead, 1984).

In the western hemisphere, the first major epidemic of DHF/DSS struck Cuba in 1981 and was responsible for 24 000 cases of DHF and 10 000 of DSS (Gubler and Costa-Valez, 1991). (Sporadic cases of suspected DHF had been reported from Central America since 1968.) Only the energetic response of the Cuban health authorities, with intensive education and mass hospitalization, kept the mortality down to just 158. Following on this epidemic, confirmed or suspected cases of DHF have been reported in the Americas almost every year, with the most severe outbreaks of DF occurring in Peru in 1990 involving over 76 000 cases (Centers for Disease Control, 1991a). Dengue returned to Cuba in 1997. A summary of the present status of dengue worldwide is that there are 2.5 billion persons at risk, more than 20 million cases per year and 30 000 deaths. Imported cases of dengue in travellers returning to temperate countries are reported in the United States annually and DHF was reported in two cases in the UK in 1991 (Jacobs *et al.*, 1991).

Virus Properties and Host Range

The dengue viruses form a subgroup of the genus

Flavivirus and, although extensive cross-reactivity is seen with serological tests such as HI, which cannot reliably distinguish dengue from many other flaviviruses, neutralization tests are able to define dengue virus as a distinct antigenic subgroup. There are four serotypes of dengue based on neutralization tests. However, with all serological tests there is extensive cross-reactivity between the four serotypes, although they are distinguishable with the highly specific plaque reduction neutralization test. Following natural infection, protective immunity is homotypic. Dengue serotypes 1, 3 and 4 show a closer antigenic and genetic relationship to each other than dengue 2. However, within each of the serotypes, considerable heterogeneity and strain variation is demonstrable on nucleic acid sequence analysis and DNA/RNA hybridization studies, as well as by antigen signature analysis using monoclonal antibodies. The importance of these strain variations with respect to the epidemiology and virulence of the virus remains to be determined. Molecular analysis of isolates from the South Pacific suggested that the recent epidemics (1988–1989) were due to a new genotype rather than a previously circulating strain.

The only vertebrate hosts of *Dengue virus* in nature are humans and several species of Asian and African subhuman primates. Other vertebrates can be experimentally infected only with difficulty, including baby mice which usually require several blind passages of patient material to obtain an isolate. The vertebrate hosts of dengue are members of the genus *Aedes*, especially the subgenus *stegomyia*. The most important mosquito hosts as far as human infection is concerned are *Ae. aegypti*, *Ae. albopictus* and *Ae. polynesiensis*. Other *Aedes* species, including *Ae. africanus*, *Ae. leuteocephalus* and the *Ae. furcifer* group, are involved in the maintenance of the forest cycle of dengue in Africa, whereas in Asia the mosquitoes concerned belong to the *Ae. niveus* complex.

Epidemiology

Dengue displays many epidemiological similarities to yellow fever and chikungunya viruses and there is considerable overlap in the ecologies of these three virus infections. Essentially there are three transmission cycles of dengue: a forest cycle in pri-

mates and involving forest species of *Aedes*; a rural or semirural cycle in humans with the peridomestic *Aedes* species being the vectors; and an urban cycle in humans involving domesticated *Aedes* species. By far the most important of these three for both endemic and epidemic human dengue is the urban cycle. It is, in fact, doubtful whether the forest cycle plays any significant direct role in human dengue.

The two major mosquito vectors of urban dengue are *Ae. aegypti* and *Ae. albopictus*. Although *Ae. albopictus* is considered more sensitive to oral infection with dengue viruses, *Ae. aegypti* is a more important vector for human disease and is especially responsible for explosive epidemics. The anthropophilic *Ae. aegypti* usually preferentially feeds on humans and occasionally also on domestic animals, while the purely domestic *Ae. albopictus* randomly feeds on humans, domestic animals and feral animals and birds. To establish infection, *Ae. aegypti* would need to feed on individuals with high levels of viraemia and this may select for viral strains of higher virulence which are more likely to produce the severe epidemics associated with *Ae. aegypti*. In addition, the biting habits of *Ae. aegypti*, which characteristically takes interrupted blood meals and will thus feed on a number of individuals before becoming engorged, enhances its ability to spread the virus. It is thus not unusual for a single mosquito to spread infection amongst several individuals at a single feeding. In both mosquitoes, biting activities are maximal soon after daybreak and in late afternoon, and are related to human activities and movements. Outbreaks associated with both vectors are climatically influenced by heavy rainfall and high temperature.

The recent upsurge of dengue in existing endemic zones and the spread to new areas has been attributed to modern phenomena of human and social behaviour. Infestations of *Ae. aegypti* in tropical towns and villages, which were controlled by extensive spraying and other vector control measures in the 1950s and 1960s, have now resurged due to uncontrolled urbanization and the mass migration of rural populations into informal housing settlements and squatter camps on the peripheries of cities and towns. These population movements have been accentuated by famine, poverty and war. Stagnant water pools and lack of reticulated water supplies have provided ample opportunities for mosquito breeding, coupled with the breakdown of vector control in many tropical countries. Over-

crowding and grossly inadequate housing, which is so characteristic of the sprawling slums of the tropical world, greatly facilitate the spread of vector-borne diseases and are especially conducive to dengue transmission resulting from the interrupted feeding habits of *Ae. aegypti*. The spread of infection has also been enhanced by the modern era of jet travel, which facilitates the transportation of infected individuals to non-infected areas, creating the threat of the introduction of infection if infestations of *Ae. aegypti* are sufficiently high. Modern air travel has also been responsible for increasing the number of imported cases of dengue into countries where physicians are, in the main, ignorant of the infection, resulting in perplexing diagnostic difficulties until a history of travel to endemic zones is elicited. More recently, the influence of international trade in the spread of dengue has been observed. Motor vehicle tyres and casings from southeast Asia, containing remnant pools of water where infected *Ae. albopictus* mosquito larvae have been found, have been shipped to various non-endemic areas of the world, posing a serious threat of introducing both the virus as well as its vector.

Clinical Features

The majority of infections with *Dengue virus*, based on the extent of population seropositivity, are asymptomatic. Clinical manifestations of dengue occur in two forms: classical DF and DHF/DSS. Classical DF is an acute disease characterized by a sudden onset of fever, severe headache which is typically frontal in distribution, together with retro-orbital pain, nausea and vomiting. Severe muscle and bone pain and arthralgia are characteristic of dengue and usually more pronounced in the back, which has led to it being termed 'break bone fever' by Dr Benjamin Rush in 1778. He also aptly described the associated severe depression as 'break heart fever'. There is frequently a diffuse, discrete maculopapular rash which usually heralds the recovery phase of the illness. In spite of the severity of symptoms which may be incapacitating, the disease is temporary and full recovery takes place.

The grave complication of DHF/DSS is governed by two factors: prior infection and age. Thus, DHF and DSS occur in approximately 0.18% and 0.007%, respectively, of cases of primary DF com-

pared with 2.0% and 1.1%, respectively, of DF due to secondary infection (Halstead, 1981). It is also rare in individuals over the age of 15 years. DHF/DSS resembles yellow fever in its biphasic presentation. The first phase is not unlike uncomplicated DF. This is followed by a brief remission of symptoms when the fever subsides to normal or close to normal. There is then a sudden deterioration in the patient's condition, marked by profound prostration, hypotension, circulatory collapse and manifestations of bleeding and shock. Bleeding is commonly seen as petechiae in the skin and mucous membranes, especially in the oral cavity, ecchymoses, bleeding at injection and skin puncture sites, gastrointestinal bleeding and haemorrhagic pneumonia.

The cause of the haemorrhagic diathesis in DHF is complex. There is evidence of vascular injury with increased permeability and extravasation of fluid from the vascular into the interstitial fluid compartment, producing hypotension and DSS. Bleeding due to vascular damage is suggested by the presence of petechiae and a positive tourniquet test. There is, in addition, a marked thrombocytopenia, although it is not yet clear what the relative contributions are of impaired platelet formation due to direct suppression of megakaryocyte production in the bone marrow or excess destruction due to endothelial damage. Evidence exists for both. Thirdly, there is haematological evidence of a consumptive coagulopathy with a moderate increase in fibrin degradation products which, however, rarely reaches the stage of disseminated intravascular coagulation.

The definition of DHF is controversial. The WHO criteria for DHF are an acute onset of fever, haemorrhagic manifestations which include at least a positive tourniquet test, a thrombocytopenia of $100\,000\text{ ml}^{-1}$ or less and a haemoconcentration with a haematocrit increase of 20% or more. Manifestations of haemorrhagic fever, however, do differ from country to country and amendments to the criteria have been proposed to include, amongst others, references to the age of the patient (less than 16 years) (Halstead, 1989). The severity of DHF/DSS has also been graded by the WHO from I to IV (Anonymous, 1980):

Grade I Fever with non-specific, constitutional symptoms and the only haemorrhagic manifestations being a positive tourni-

- quet test.
- Grade II* As for grade I, but with specific haemorrhagic manifestations.
- Grade III* Signs of circulatory failure or hypotension.
- Grade IV* Profound shock with pulse and blood pressure undetectable.

Pathogenesis of DHF/DSS

The pathogenesis of DHF/DSS has been intensively studied for a number of decades. Nevertheless, the pathways to the development of severe dengue have not, as yet, been definitively established. Essentially there are two hypotheses involving immunological or virological mechanisms.

The immunological theory of DHF/DSS is based on the phenomenon of antibody-mediated enhancement of infection. Investigations of antibody-mediated enhancement in dengue have been the hallmark studies of this phenomenon, which have since been shown to be important facets in the pathogenesis of a number of viral diseases, from rabies to HIV (Kurane *et al.*, 1991). The major cell infected by *Dengue virus in vivo* is the monocyte/macrophage cell (even though a number of cell lines from a variety of tissues may be infected *in vitro*). Three elements partake in the process of antibody mediated enhancement: antibody, virus and the receptor for the Fc portion of IgG.

Evidence for the involvement of pre-existing antibodies comes from epidemiological observations that DHF/DSS is much more common in individuals with pre-existing antibodies. These pre-existing antibodies may be derived from passively acquired maternal antibodies in infants less than 1 year of age, or from previous infection in children over 1 year of age. This was particularly evident in the Cuban epidemic of 1981 when DHF/DSS due to type 2 virus was usually observed in individuals infected some 4 years previously with type 1 virus. Experimental work by Halstead and colleagues demonstrated enhancement of infection in experimental dengue in monkeys using human serum as well as sera from hyperimmunized animals. It was later demonstrated that only IgG antibody and not IgM, which has potent neutralizing activity, was able to produce enhancement. Using monoclonal antibodies, enhancing epitopes on the E and pre-M

proteins of dengue virus could be demonstrated, some of which could also be neutralizing and others not (Kurane *et al.*, 1991).

The receptor on the monocyte/macrophage cells which form the third component of the enhancing complex is thought to be the FcRI molecule which binds the Fc portion of IgG with great avidity, and also, but probably to a lesser extent, the FcRII molecule. The effect of the attachment of the virus-antibody complex to the FcR receptor is both to enhance the binding of virus to its target cell and also to induce a signal to the cell facilitating internalization of the complex. There remain, however, many unanswered questions with the antibody-mediated enhancement hypothesis. Firstly, DHF/DSS may well occur in the absence of pre-existing antibodies, even though it is far more common for them to be there. It is also not clear whether binding of virus to its specific receptor is essential for infectivity. The mechanism by which enhanced infection of cells produces the components of a DHF/DSS syndrome is not known.

The alternative hypothesis of Rosen and colleagues (Rosen, 1986) holds that the severe complications of DHF/DSS are the direct results of properties of the virus, that is, the consequence of infection with unusually virulent strains of dengue circulating in a particular area and giving rise to outbreaks of DHF/DSS. However, as mentioned above, although nucleic acid sequencing techniques and antigen signature analysis have demonstrated strain variations within serotypes, no consistent relationship between strain variation and either virulence or heightened infectivity has been reliably demonstrated. There has also been no consistent association with serotype and DHF/DSS. Earlier observations both in Thailand, as well as in the 1981 Cuban epidemic, suggested that dengue type 2 may be more frequently associated with DHF/DSS. Subsequent observations have now shown that all four serotypes may be responsible (Table 17.2).

Neither of these two hypotheses is able to elucidate why the development of DHF/DSS is so dependent on age or why DHF/DSS is more likely to follow when dengue infection occurs in some areas but not in others.

Diagnosis

The clinical diagnosis of dengue, both the uncom-

Table 17.2 Dengue virus serotypes in relation to major outbreaks of Dengue fever and DHF

Year	Location	Number of			Dengue serotypes
		Cases	DHF/DSS cases	Deaths	
1981	Cuba	> 200 000	3400	158	2
1988–1989	French Polynesia	20 200	N.S.	–	1
1989	New Caledonia	18 000	N.S.	–	1, 3, 4
1989–1990	Venezuela	> 6 000	3108	73	1, 2, 4
1991	Brazil	97 000	N.S.	N.S.	1, 2
1992	Colombia	59 357	N.S.	N.S.	1, 2, 4
1994	Nicaragua	20 469	1247	± 6	3
1995	Venezuela	32 280	5380	40	1, 2, 4
1995	Brazil	124 887	105	2	1, 2
1995	Honduras	27 000	35	5	1, 2, 3, 4
1996	Brazil	175 751	2	N.S.	1, 2
1996	Mexico	20 685	N.S.	N.S.	1, 2, 3, 4
1997	Thailand	77 155	N.S.	178	N.S.

DHF = dengue haemorrhagic fever; DSS = dengue shock syndrome; N.S. = data not supplied.

plicated DF form as well as DHF/DSS, is often unreliable. Dengue fever may clinically resemble a variety of acute febrile illnesses, although the severe muscle and bone pain is suggestive of dengue. Similarly DHF may resemble other causes of haemorrhagic fever, although thrombocytopenia with haemoconcentration and signs of a moderate consumptive coagulopathy is suggestive of dengue.

The most widely used serological test is the HI test, detecting antibodies as early as 4 days post onset. A specific diagnosis of dengue can be made early in primary infections, but cross-reactions with other flaviviruses occur in late primary or secondary infections. The IgM antibody capture ELISA (MAC ELISA) is being used to an increasing extent during outbreaks of dengue, and there are now rapid assays available for detection of dengue IgG and IgM, although cross-reaction may occur with the IgG assay. The IgM antibodies may persist for over 3 months, so the test is also useful for retrospective studies, but this persistence may cause diagnostic problems in areas where dengue is endemic. Immunofluorescent assays have been used successfully to detect dengue IgG and IgM antibodies. The CF test is more specific than the HI test, but the antibodies detected by this assay appear later and disappear earlier. The NT and PRNT tests are the most specific and sensitive but are difficult to perform and thus tend to be used only for specific purposes.

Virus isolation, the only definitive way of being able to type isolates, is difficult, and if mice are used

a number of blind passages are usually required. Intracerebral inoculation of adult or larval *Toxorhynchites* species is a sensitive and rapid method for the isolation of *Dengue virus*, giving results in 2–3 days. Intrathoracic inoculation of mosquitoes is easier and just as sensitive but head squashes cannot be made or tested for specific dengue antigen for at least 7 days postinoculation. The most commonly used system of virus isolation is the inoculation of mosquito cell lines from *Ae. albopictus* (C6-36), *Ae. pseudoscutellaris* (AP-61) and *Toxorhynchites ambionensis* (TRA-248), which are almost as sensitive as mosquito inoculation, which allows specific results to be obtained within 2–3 days using fluorescent-labelled monoclonal antibodies.

Control

There is, at present, no licensed dengue vaccine. Current strategy is to develop a vaccine against all four serotypes. Successful trials of monovalent vaccines have been reported, but, as yet, not for experimental tetravalent vaccines. Because of the lack of availability of a vaccine, control of dengue depends on: (1) surveillance to obtain early warning of epidemics or preferably to be able to predict impending epidemics; and (2) effective vector control.

Epidemiological surveillance may be of two types. Firstly, proactive surveillance in interepidemic periods in endemic areas or in countries

which are not yet infected but are vulnerable to the introduction of new infections because of high infestations of *Ae. aegypti*. Secondly, reactive surveillance, where monitoring is instituted once suspected or confirmed cases of dengue have already occurred. This form of surveillance is very insensitive, as numerous cases may occur which are not suspected to be dengue, before authorities are alerted to the outbreak. In the Comoros islands, dengue type 1 was diagnosed in 62 out of 116 clinical cases in 1993. However, an investigation to determine the prevalence of dengue infection in those over 5 years old, using a dengue IgM assay, estimated that at least 60 000 recent cases had occurred at that time.

A number of instruments of surveillance may be used for proactive monitoring. Disease surveillance requires intensive educational efforts, especially at peripheral primary healthcare level, to alert healthcare workers to the possibility of dengue. It is, however, very difficult to sustain interest, especially if no cases materialize. Viral and serological surveillance involves the active recruitment of specimens, as, for example, carried out in Puerto Rico, where blood samples are collected by collaborating physicians on a regular basis and sent for analysis (Gubler and Costa-Valez, 1991). Interest and cooperation are also difficult to sustain. The use of blood samples sent to laboratories for testing for acute febrile illnesses or 'viral syndromes' may be an easier way of recruiting specimens for serological testing. Surveillance may also utilize the routine investigation of all viral haemorrhagic fever cases, which should include tests for dengue. Vector surveillance may be of benefit to demonstrate low infestations (house index of $< 1\%$) or to look out for the introduction of exotic mosquito species, for example, *Ae. albopictus*.

Vector control aims at the elimination of the main mosquito vector, *Ae. aegypti*. While this is technically feasible with both adulticide campaigns using ultralow-volume spraying with malathion and larvicide treatment of stagnant water, the costs are high and the effects are temporary. In many tropical countries where *Ae. aegypti* eradication had been achieved, reinfestations have taken place to levels equalling, or even exceeding, those in pre-control times. However, long-term community-based programmes need to be implemented in endemic countries. In non-endemic countries there should be vigilant monitoring for the possible importation of dengue, for example, through motor



Figure 17.5 Geographic distribution of *Japanese encephalitis virus*

car tyres, or travellers or migrants from endemic areas.

JAPANESE ENCEPHALITIS

Japanese encephalitis (JE) virus is the major arboviral cause of encephalitis worldwide. First described as a clinical entity in Japan in 1870, it is now thought to be responsible for about 50 000 cases annually, half of whom are left with permanent neurological or psychological handicap, and in a further quarter of whom it is rapidly lethal. Infection has been demonstrated in 16 countries in southeast Asia, stretching to India in the west and to southern Russia in the north—a population of over 2 billion people (Figure 17.5).

Viral Features and Host Range

JE virus shows some cross-reactivity with *St Louis encephalitis virus*, *West Nile virus* and *Murray Valley encephalitis virus*, and together they form the mosquito-borne encephalitis complex. The virus is antigenically relatively homogeneous and recovery from infection results in solid protection. Nucleic acid analysis, however, has revealed some significant heterogeneity. Using primer extension sequencing, isolates of JE virus could be separated into three distinct genotypic groups, each group found in separate geographic divisions (Chen *et al.*, 1990). The epidemiological significance of this remains to be established.

The vertebrate hosts of JE virus are humans and

their domestic animals and birds; no wild animals and birds are known to be infected to any significant extent. The major mosquito vector of the virus is *Culex tritaeniorhynchus*, although a number of other species of *Culex*, *Mansonia*, *Aedes* and *Anopheles* genera have yielded isolates of JE virus.

Epidemiology

Nestling birds, particularly of the heron family, play an important epidemiological role in the dissemination of JE virus, with a second cycle involving domestic animals, particularly the pig. In seroprevalence studies high NT antibodies were found in several other animal species, e.g. cattle, horses, dogs, monkeys and bats. As with the wild bird population, the high turnover of the domestic pig population, resulting in a continuous supply of susceptible animals, is a contributing factor to the pig being a major amplifying host for JE virus. JE rarely causes disease in domestic animals, although fatal encephalitis in horses and abortions in sows have been recorded. Studies on birds have implicated other species whose main habitat is the rice paddies, as vertebrate hosts of JE virus; these water birds include water hens and bitterns. In India ardeid birds such as cattle egrets are implicated.

JE virus has been isolated from many species of mosquito but the principal vector in many areas is *C. tritaeniorhynchus*. Other mosquitoes, mainly the *Culex* species, are considered to be important in specific regions, e.g. *C. gelidus* in southeast Asia, for the transmission of JE virus.

Humans are dead-end hosts and play little role in the amplification of the virus. JE is thus predominantly a rural problem, with disease closely related to rainfall and irrigation.

Clinical and Pathological Features

Infection with JE virus is considerably more widespread than the incidence of encephalitis would indicate. Infection may present non-specifically as a mild febrile illness or as an aseptic meningitis or, rarely, as a variety of inflammatory manifestations in the viscera. The typical disease manifestations of acute meningoencephalitis have been widely estimated to occur at between 1 in 20 (Rodrigues,

1984) to 1 in 600–800 persons infected (Halstead, 1981).

The major target cells for JE virus are the T lymphocyte and the peripheral blood mononuclear cells. In fatal cases of encephalitis, viral antigen is also demonstrable in the neurons. Factors determining the neuroinvasiveness of JE virus involve both viral and host factors. Nucleotide sequencing of non-neurovirulent mutants of JE virus have demonstrated single base changes in the coding region for E protein (Cecilia and Gould, 1991). Age is an important host factor determining neurovirulence, encephalitis being more common and more severe in the young as well as in elderly individuals. Experimental work in rats has shown a relationship between neurotropism and neuronal maturity, in that the virus selectively infects immature neurons (Ogata *et al.*, 1991). The reason for greater neuroinvasiveness in the elderly is unknown, but is consistent with the features of the related *St Louis encephalitis virus* and *West Nile virus*, which similarly display greater neuroinvasiveness in the elderly.

The typical case of JE commences after an incubation period of 1–2 weeks, with fever and headache, followed rapidly by depression of the level of consciousness, progressing from stupor to coma. Localizing cranial nerve and other neurological signs occur in about 30% of cases and in children generalized seizures are common. A quarter of cases of clinical encephalitis will recover with no permanent sequelae and a quarter will die rapidly. The remaining half will recover with varying degrees of permanent neuropsychiatric sequelae. In addition, especially in children, the virus may persist in lymphocytes and reactivate to give recurrent disease after recovery (Sharma *et al.*, 1991).

Grave prognostic signs include a short prodromal period, deep coma, decerebrate posture, breathing abnormalities and the ability to isolate virus from the cerebrospinal fluid (CSF). Recently a reduction of serum iron levels has been demonstrated in patients due to the sequestering of iron in the spleen, and a direct relationship between low serum iron and prognosis has been shown (Bharadwaj *et al.*, 1991).

The pathology of the brain in fatal cases has revealed microfoci of necrosis scattered throughout the central nervous system, but especially involving the thalamus, the basal ganglia and the deep cerebral nuclei.

Diagnosis

Routine diagnosis is usually carried out by serology using HI, IF, CF or ELISA techniques. Test results should, however, be treated with caution because of extensive cross-reactivity with other flaviviruses and because up to a quarter of patients fail to demonstrate a serological rise in titre due to their late presentation to medical attention. A preferable serological test is the IgM antibody capture ELISA on serum or CSF. The detection of specific IgM antibodies in CSF is diagnostic of acute JE.

Virus isolation from blood is rarely successful during the acute illness because the viraemic phase is probably over by the time central nervous system symptoms appear. Virus isolation from the CSF is usually also unsuccessful and, if positive, indicates a poor prognosis, as mentioned above. A variety of isolation techniques are very sensitive to JE virus, including intracerebral inoculation of suckling mice, intrathoracic inoculation of live mosquitoes, and the use of common mammalian cell lines such as Vero and LLC-MK2 and mosquito cell lines, especially those of *Ae. albopictus* and *Ae. pseudocutellaris*.

Control

The major component of the control of JE is widespread immunization of both humans and domestic animals, especially pigs. A number of human vaccines have been developed. A formalin-inactivated lyophilized vaccine of mouse brain origin, derived from the Nakayima–NIH strain of JE virus, is prepared by Biken, Japan, and widely used in Japan and Korea and also by travellers to endemic areas. In China, a BHK prepared inactivated vaccine is used. Both vaccines are highly immunogenic and protection rates of over 90% are achieved. Experimental live attenuated vaccines are being developed and Chinese workers have successfully attenuated the SA14 strain by 100 passages in BHK cell culture (Stephenson, 1988). Recombinant DNA technology also holds promise for the future development of safe, effective JE vaccines (Konishi *et al.*, 1991). Similarly, a number of veterinary vaccines have been used in pigs and horses. Vaccination thus holds the potential to eliminate JE. Reports of allergic reactions to the Biken vaccine (Ruff *et al.*, 1991)

have resulted in a cautionary warning being issued against routine administration of JE vaccine to travellers, except to those who are likely to be at high risk in endemic areas, particularly rural areas, for a month or longer during the season of vector activity (Nothdurft *et al.*, 1996).

Because humans are only incidental hosts, interruption of transmission of the virus would be independent of the extent of immunity in human populations and eradication of infection would need to aim for the elimination of virus circulating in the vertebrate reservoir of domestic animals. At present economic realities preclude anything approaching a sufficiently widespread programme of immunization in domesticated pigs.

Vector control is difficult because of community resistance to mosquito control programmes which need to include, and may significantly tamper with, subsistence agriculture of rural populations. Thus, methods which have been attempted include short-term drainage of rice fields and attempts to introduce more drought-resistant rice in order to reduce potential mosquito breeding sites. Ultralow-volume insecticide spraying has had limited success, with increasing insecticide resistance, especially in *C. tritaeniorhynchus*. Measures to prevent biting by mosquitoes, such as the use of insect repellants, mosquito netting, etc., should be encouraged. Most biting activity is concentrated at nightfall.

ST LOUIS ENCEPHALITIS

St Louis encephalitis (SLE) *virus* is the major cause of epidemic viral encephalitis in the USA. Although the distribution of the virus ranges from southern Canada to Argentina, and a few sporadic cases have been reported in South and Central America, virtually all human disease has occurred in the USA (Figure 17.6).

Viral Features and Host Range

SLE is antigenically closely related to the other members of the JE subgroup of flavivirus. In addition, cross-immunity to other flaviviruses has also been demonstrated, including *Dengue virus* type 2. Antigenic heterogeneity has been shown with monoclonal antibodies, although there is no evidence



Figure 17.6 Geographic distribution of *St. Louis encephalitis virus*

that this has any epidemiological implications. By means of T1 restriction mapping, a number of genotypes of SLE have been defined and have been used as epidemiological markers.

The major vertebrate hosts of SLE are birds, especially domesticated sparrows (*Passer domesticus*), which act as the main amplifying host (Centers for Disease Control, 1991b). In addition, small mammals such as racoons, opossums and rodents are also infected, as well as a variety of domestic animals. However, other than birds, there is no evidence that animals play any role as maintenance or amplifying hosts.

Invertebrate vectors of SLE are various species of *Culex* mosquitoes, depending on location. In the rural west it is *C. tarsalis*, in the northern and southern regions of the central United States it is mainly *C. pipiens* and *C. quinquefasciatus*, and in Florida *C. nigripalpus*.

Epidemiology

In all parts of the United States the transmission cycle of SLE involves birds and mosquitoes. Hu-

mans and probably domestic animals are incidental and dead-end hosts. Epidemiological characteristics, however, differ in the three regions described above. Thus, in the central USA where *C. pipiens* and *C. quinquefasciatus* are the major vectors, epidemic outbreaks result from the build-up of virus in domesticated house sparrows and mosquito larvae breeding in discarded containers and open house foundations characteristic of older housing construction. Regular outbreaks have occurred at approximately 10 year intervals until 1977, followed by irregular, unpredictable outbreaks observed in large urban localities. In the western United States, SLE occurs as low-grade endemic activity transmitted by *C. tarsalis* and associated with agricultural irrigation, although there are exceptions, such as the large focal outbreak in Los Angeles in 1984, which was probably due to *C. pipiens* acting as an accessory vector.

Clinical Features

The majority (over 90%) of infections with SLE virus are asymptomatic. In clinically apparent cases, the disease is characterized by an abrupt onset of a febrile illness accompanied by constitutional symptoms of malaise, nausea, vomiting and headache. Occasionally there may be a more slow insidious onset. Central nervous system involvement may be in the form of aseptic meningitis or focal encephalitis. Encephalitis signs may be manifest as neck stiffness, dizziness, ataxia, mental confusion and disorientation. Cranial nerve palsies may occur in about 20% of cases, but the absence of focal findings or seizures may be useful differential features to distinguish SLE from cases of focal encephalitis such as herpes simplex. In more severe cases there may be midbrain involvement and progressively severe coma. Overall case fatality is approximately 7% of symptomatic cases, although in outbreaks it may reach 20%. The likelihood of encephalitis, and also its severity, is directly related to age, with case fatalities in the elderly during outbreaks reaching 30% (Monath, 1980).

Diagnosis

For rapid serological diagnosis of SLE infection the

IgM antibody capture ELISA is the method of choice, using either serum or CSF. Cross-reactions may occur if other flaviviruses are active in the area, but this is not a major factor in North America. The IF test on SLE-infected cells is a useful alternative to the IgM ELISA for testing sera and the HI test may be used for surveys or diagnosis if acute and convalescent sera are available. In regions where flavivirus activity is confined mainly to one virus, the HI test would be a useful screening test, followed by the SLE IgM antibody capture ELISA test to determine recent SLE infection.

Control

Although Sabin developed an inactivated mouse-brain vaccine during the second world war, no licensed vaccine is presently available because of the low priority accorded the infection. Similarly, specific vector control programmes directed at SLE are either impractical or thought not to be of sufficient urgency. Secondary measures to protect against mosquito bites, such as insect repellent and screening, may be of some benefit during reported outbreaks.

WEST NILE VIRUS

West Nile (WN) virus infection is one of the most ubiquitous of human arbovirus infections, being found throughout Africa, in Asia and in parts of Europe (Figure 17.7). The virus was first isolated in the West Nile province of Uganda in 1937.

Viral Features and Host Range

WN virus is related by neutralization tests to the other members of the JE subgroup of flaviviruses, particularly *Kunjin virus*, which is believed to have evolved from, or is a variant of WN virus.

The major vertebrate hosts of WN virus are birds, although in addition the virus is able to infect a variety of domesticated and wild animals as well as humans and subhuman primates. The maintenance vectors of WN virus consist of a variety of mosquitoes, especially of the genus *Culex*.

On the basis of antigenic studies of isolated vi-



Figure 17.7 Geographic distribution of *West Nile virus*

uses, WN virus can be broadly classified into two groups: strains arising from the Middle East, Africa and Europe, the so-called Palearctic group, and an Indian group. Recent monoclonal studies have shown South African isolates to be distinct from either group and that the antigenic classification may be somewhat more complex (Besselaar and Blackburn, 1988).

Epidemiology

The transmission cycle of WN virus consists mainly of wild birds as the vertebrate host and ornithophilic *Culex* mosquitoes as the maintenance vector. The major *Culex* mosquito vector in Africa and the Middle East is *C. univittatus*, in southeast Asia *C. tritaeniorhynchus*, and in France *C. modestus*.

Major epidemics of WN disease have been reported in Israel during the 1950s, in France in 1962 and the largest epidemic ever recorded took place in South Africa in 1974, which involved tens of thousands of individuals. Epidemics have characteristically occurred in relatively localized areas, for example, close to Tel Aviv in the Israeli epidemic, in the Rhone delta in France and the semidesert Karoo region and in and around major cities of the highveld of South Africa. The distribution of WN virus in South Africa is predominantly in the inland plateau region where it shares the same geographical distribution and ecology as *Sindbis virus*, which also produces a disease which is usually clinically

indistinguishable from WN infection.

Outbreaks of WN virus, as with many other arboviruses, have been governed by climatic conditions such as heavy rainfall, particularly in early summer, and high summer temperatures. During outbreaks high attack rates in humans have been observed, for example, in some of the worst affected towns in South Africa, 50–80% of the human population were infected due to the high rate of feeding by *C. univittatus*. This mosquito is probably also responsible for sporadic cases in interepidemic periods. Because viraemia is low in humans, epidemic activity is directly due to infection of mosquitoes from viraemic birds, and human outbreaks are merely the spill-over of extensive epizootic activity in birds—an important factor which facilitates epidemiological surveillance. Furthermore, no human-to-human transmission occurs and, as in the case of JE, human population immunity has no bearing on the suppression of epidemic activity itself and susceptible individuals would remain vulnerable irrespective of the proportion of immune individuals in the population.

Clinical Features

In the majority of cases WN infection presents as a mild febrile illness. The onset of disease is characteristically sudden following a short incubation period of 3–5 days. Fever is usually the first sign, followed by headache, nausea and vomiting. Ocular pain is frequently reported, as is pharyngitis. Muscle pain occurs diffusely and there may be arthralgia.

During the first few days after onset, a discrete maculopapular rash usually appears, with each of the rash elements demarcated by a sharp halo. The rash usually first appears on the trunk and then spreads to the face and extremities, and may persist for a week. Unlike measles, there is no desquamation.

Convalescence is rapid in children but may be somewhat more prolonged in adults and characterized by weakness and malaise. The illness not infrequently recrudesces during the convalescent period.

Although WN virus is classified virologically within the JE group of mosquito-borne encephalitis, involvement of the central nervous system is very rare. Initially, meningoencephalitis was thought to occur exclusively in the elderly. More

recently, however, a growing number of cases in children have been reported from various parts of the world.

Rarely cases of visceral involvement including severe hepatitis, occasionally with a haemorrhagic presentation, have been reported.

Diagnosis

The HI, CF or NT tests can be used for serological diagnosis of WN infection. The HI test, which detects antibodies within a few days after onset, is probably the method of choice. Cross-reactivity is not a problem in patients with no previous exposure to flavivirus infection or vaccination. An IgM antibody capture ELISA is increasingly used as a diagnostic test for WN virus infection, normally in conjunction with the HI, which is used as a screening test.

Virus isolation may be readily achieved from blood from infected individuals, despite lower levels of viraemia. Suckling mice are particularly sensitive to intracerebral inoculation, and cell culture of mammalian origin as well as insect cell lines are commonly used for virus isolation.

Control

With the relatively low impact of WN virus on human health, there has been no great impetus for the development of a vaccine. During outbreaks, vector control by insecticide spraying may be applied. Epidemiological surveillance makes use of sentinel animals, such as hamsters, goats, guinea-pigs or pigeons, to detect early warning signs of impending outbreaks.

MURRAY VALLEY ENCEPHALITIS

Murray Valley encephalitis (MVE) is a relatively uncommon cause of human disease—less than 1000 cases have been reported—all of them confined to Australia and New Guinea.

The disease was first recognized during two epidemics of a virulent encephalitis in Queensland and in the Murray Valley in 1917 and 1918. A number of epidemics were subsequently described until 1925,

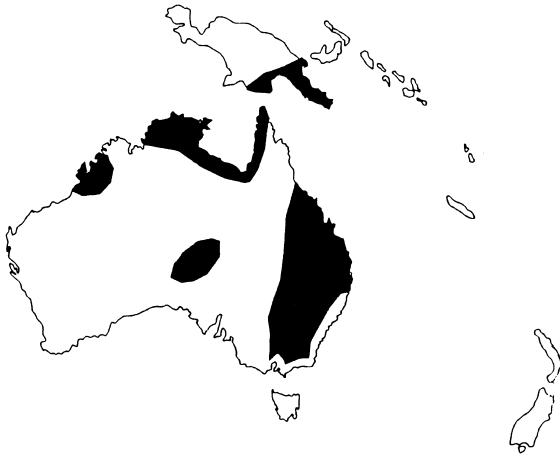

Figure 17.8 Geographic distribution of *Murray Valley encephalitis virus*

followed by an inexplicable gap until the 1950s. The last substantial epidemic took place in 1974 and since then only some individual sporadic cases have occurred.

The infection is found in a patchy distribution from New Guinea through Darwin to the northern parts of Western Australia and down the east coast as far south as Brisbane, and in the basin of the Murray Darling River (Figure 17.8).

Viral Features and Host Range

The virus displays a close relationship with *Kunjin virus* and also JE virus. Two distinct strains can be demonstrated, a New Guinea and an Australian variant. Individual isolations within the two groups are, however, remarkably conserved.

Epidemiology

The major maintenance vector is *C. annulirostris* and a number of vertebrate hosts, chiefly wild birds, are involved in the transmission cycle. Domestic animals are infected, but they probably do not play any significant role as amplifying hosts. Outbreaks have characteristically occurred in the summer months.

Clinical Features

As with most other arboviruses, the vast majority of infections are asymptomatic—only about 1 in 800–1000 infections being clinically manifest (Anderson, 1954). Once clinical disease occurs, however, high case fatality rates, from 18 to 42%, have characterized the various outbreaks. The clinical features in symptomatic patients are a sudden onset of high fever (up to 40.6°C), nausea, vomiting and severe frontal headache. Signs of encephalitis vary from mild neurological involvement with disturbances of consciousness and neck stiffness to rapid onset of coma with respiratory failure. Patients with severe neurological involvement and coma, who were kept alive on life-support systems, and subsequently survived, all have had remaining permanent and severe sequelae.

Diagnosis

Serology is generally carried out by HI or ELISA tests. The virus may also be isolated by intracerebral inoculation of suckling mice or on cell culture.

TICK-BORNE ENCEPHALITIS

The tick-borne encephalitides are a closely related subgroup of viruses within the genus *Flavivirus*. Although serological tests such as HI and CF give considerable cross-reactivity with members of the flavivirus group, the tick-borne encephalitis (TBE) subgroup of flavivirus are far more closely antigenically related to each other. In contrast to many of their mosquito-borne arbovirus counterparts, the tick-borne encephalitis subgroup is found almost exclusively (with some exceptions such as louping ill in the UK and Powassan in North America) in Asia and eastern and central Europe. Within the subgroup is the entity of TBE, which consists of two subtypes: TBE—Central European subtype or *Central European encephalitis (CEE) virus*; and TBE—Far Eastern subtype or *Russian spring–summer encephalitis (RSSE) virus*. Others within the subgroup of the TBE are *Omsk haemorrhagic fever virus*, *Kyasanur Forest disease virus* and *Powassan virus*, which will be considered separately.

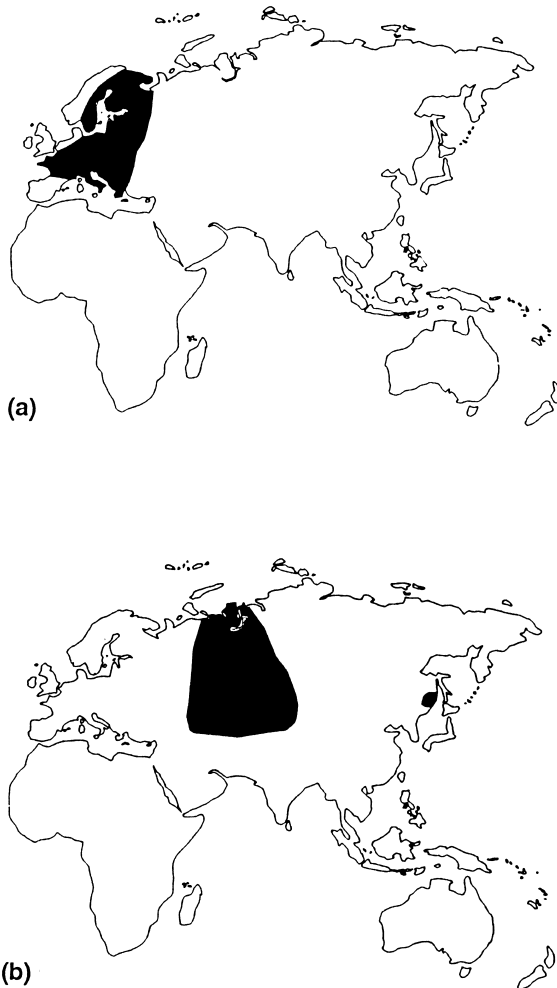

Figure 17.9 Geographic distribution of (a) *Central European encephalitis virus* and (b) *Russian spring-summer encephalitis virus*

Viral Features

CEE and RSSE viruses are particularly closely related to each other and are distinguishable only by monoclonal antibodies or specialized techniques such as antibody absorption tests. However, monoclonal antibody studies of CEE, especially those directed against glycoprotein domains, demonstrate a degree of antigenic complexity. Also, studies of different isolates of RSSE from different geographical locations have shown a heterogeneity of biological characteristics such as mouse

pathogenicity and plaque size. The two viruses display clearly distinguishable biological differences from each other. The distribution of the two infections closely follows that of their arthropod vectors, *Ixodes ricinus* in the case of CEE and *Ixodes persulcatus* in the case of RSSE. The geographical distribution of CEE stretches from Russia in the east through Finland and Sweden in the north, through Germany to France in the west and down to Italy, Greece and Yugoslavia in the south, encompassing the central European countries in between (Figure 17.9). RSSE is found predominantly in the taiga (the coniferous forest belt on the edge of the steppes and the tundra region of Siberia) and in western Siberia. Their pathogenic potentials are also different, CEE causing a very much milder disease in experimentally infected sheep and monkeys as compared to RSSE, and this is reflected also in the clinical expression of their respective infections in humans. Domestic animals, such as sheep, goats and cows, infected with CEE excrete virus in their milk. The virus is also relatively stable to low pH and, experimentally, animals can rarely be infected by oral inoculation. In humans, milk-borne transmission of CEE through ingestion of goat, sheep or cow's milk, or dairy products made from them, such as cheese, is an important route of acquisition of infection.

Epidemiology

Both CEE and RSSE are endemic diseases with an increased seasonal incidence in the summer months related to climatic conditions of temperature and humidity which affect tick activity. Infections occur predominantly in rural populations, especially farmers and forest workers. In addition, some 10–20% of CEE infections are transmitted through the ingestion of goat, sheep and cow's milk and dairy products. Seroprevalence studies of RSSE virus have shown population prevalences of up to 50% in inhabitants of the taiga. Seroprevalence to CEE depends on rural residence, occupation and age. Thus, in various studies in central Europe, seroprevalence figures of 11–20% have been found in hunters, 5% in farmers and 1% in children (Gresikova *et al.*, 1973).

Clinical Features

Disease due to CEE is relatively mild, with a low fatality of less than 5%. The incubation period is 1–2 weeks followed by symptoms and signs of a non-specific febrile illness, headache, nausea, vomiting and lassitude, and occasionally some signs of neurological disorders may appear, especially related to visual disturbances: blurring of vision and diplopia. This initial viraemic phase of the illness usually lasts some 4–6 days and is followed by a brief remission period. The majority of individuals infected probably only experience a monophasic illness which is rarely diagnosed specifically.

The second phase of the biphasic illness commences after a brief remission period and is heralded in by a recrudescence of fever and signs of meningitis. The most important signs of encephalitis are extrapyramidal and cerebellar syndromes which may often persist for months after recovery. Localizing neurological signs such as cranial nerve involvement occur uncommonly and are usually mild. The mortality in various outbreaks which have been studied has varied from 1 to 5%.

A more severe degree of encephalitis is usually seen with RSSE virus. The incubation period is similar but is usually followed by sudden onset of fever and constitutional symptoms and, in the second phase of illness, a more intense meningitis. In some individuals an aseptic meningitis picture may be the sole clinical manifestation of disease. In others, encephalitic signs and symptoms such as disturbed consciousness may lead to stupor, coma and death. A characteristic feature is lower motor neuron paralysis, which may resemble poliomyelitis but usually predominantly affects the upper limbs, spreading to the neck, and which may be followed by bulbar paralysis and death. The reported case fatality rates have varied from 8 to 54%. In addition, residual paresis and atrophy of muscles of the upper limbs and neck may persist for long periods. Post recovery epileptiform seizures may reflect permanent neural damage.

Diagnosis

The IgM antibody capture ELISA on serum or CSF is the serological test of choice for diagnosis of TBE virus infection. The HI test is useful but a

significant rise in antibody level must be demonstrated before a diagnosis can be made. Virus can be isolated from blood or CSF but specimens must be taken early after onset of symptoms. The virus may also be readily isolated from postmortem tissues such as brain and also infected tick pools. The virus is readily isolated by intracerebral inoculation of suckling mice or cell cultures such as Vero or chick embryo.

Control

Vaccines have been developed against both CEE and RSSE viruses. In the case of CEE a number of candidate vaccines have undergone trials. The most commonly used human vaccine, FSME-Immun, has been administered extensively in central Europe with very few mild allergic-type side-effects (Stephenson, 1988). The seed virus was derived from an Austrian tick isolate cloned in chick embryo cells and the vaccine has proved to be highly effective. A non-pathogenic related virus isolated from a bank vole, the *Skalica virus*, is being investigated as a possible candidate for a live attenuated vaccine.

The development of vaccines for RSSE has been less successful. The original RSSE vaccine, developed by Silber soon after the recognition of the infection in 1937, consisted of an inactivated suspension of infected mouse brain. However, the presence of contaminating myelin posed an unacceptable risk of encephalitogenic side-effects and its use in humans was discontinued. Several attempts at developing a tissue culture-grown vaccine strain have not yielded a successful human vaccine. As with CEE, a surrogate non-pathogenic virus is being investigated as a possible live attenuated vaccine strain—the Langat TP21 virus isolated in Malaya.

OMSK HAEMORRHAGIC FEVER

Viral Features and Host Range

Omsk haemorrhagic fever (OHF) is closely related to TBE and cannot be differentiated using polyclonal hyperimmune sera. They are differentiated on gel precipitation using cross-absorbed monospecific sera. The infection is conveyed by ixodid ticks, *Dermacentor reticulatus* and *Dermacentor*

marginatus. A number of animal species are susceptible and the virus has been isolated from wild rodents. However, the most important vertebrate host is the muskrat (*Ondatra zibethica*), which is highly susceptible to infection, the virus usually producing a rapidly fatal haemorrhagic disease. The virus is excreted in the urine and faeces of sick animals, and horizontal infection as well as arthropod infection is thought to play a role in transmission. The majority of human infections (60%) have occurred in hunters of muskrats, with transmission occurring as a result of direct contact during the skinning of animals. A further 28% of infections occur in adult family contacts of hunters.

Epidemiology

Infection has been limited to the Omsk region in the forest-steppe landscape of western Siberia adjacent to TBE endemic zones (Figure 17.10). The majority of cases were recorded between 1945 and 1949. Between 1945 and 1958, a total of 1488 cases were recorded, with no typically transmitted cases occurring since then. Occasional laboratory acquired infections have been reported (Jelinkova-Skalova *et al.*, 1974).

Clinical Features

Clinically the disease presents with a sudden onset of fever, headache and myalgia. There is a recrudescence of fever followed by haemorrhagic manifestations, especially epistaxis but also gastrointestinal bleeding and bleeding at other sites. Bronchopneumonia is a frequent complication and occasionally meningitis may occur, with long-term complications such as psychomotor retardation and depression.

Diagnosis and Control

Infection may be diagnosed by isolation of virus from patients' blood and intracerebral inoculation into suckling mice. Serological testing by ELISA, CF and NT is also available. Control measures to prevent infection involve the avoidance of ticks and care in handling muskrat carcasses in endemic areas,



Figure 17.10 Geographic distribution of *Omsk haemorrhagic fever virus*

as well as laboratory safety measures. Because of extensive cross-reactivity, CEE vaccine would probably impart good protection.

KYASANUR FOREST DISEASE

Viral Features and Host Range

The first isolation of *Kyasanur Forest disease (KFD) virus* was made in 1957 from a dead monkey found near the Kyasanur State forest in Karnataka (formerly Mysore) State in India. A few months previously a lethal epizootic amongst monkeys had been reported in the adjacent forested areas, with human cases termed by the villagers as 'monkey disease'. So far all human cases have been limited to Karnataka State—on an average about 500 per year—in addition to a number of laboratory acquired infections both in India as well as in the USA. There is no evidence of the disease having existing prior to 1957.

Epidemiology

In addition to monkeys, a number of rodents are known to be infected, such as rats, as well as shrews, bats and other animals. The main tick vector is

Haemaphysalis spinigera. Infection occurs predominantly in poor villagers working in forests.

Clinical Features

The disease is characterized by a sudden onset of fever after an incubation period of 3–8 days. The fever may rise rapidly to 40°C, associated with headache and severe myalgia reminiscent of dengue fever. Muscle pain is also predominantly found in the back and neck regions. A regular finding in patients in the acute stage is papulovesicular lesions on the soft palate. There is usually a cervical and axillary lymphadenopathy but occasionally this is generalized. Earlier reports of the disease laid great emphasis on the haemorrhagic manifestations, which occur as early as the third day of illness. These consist of bleeding from the nose, gums and gastrointestinal tract. Associated with this there is a marked thrombocytopenia and neutropenia, but no evidence of bone marrow suppression or capillary damage. The cause of the haemorrhagic diathesis has more recently been thought to be autoimmune in nature (Pavri, 1989). Many of these earlier cases were reported in poor villagers who were often infected with bacteria and parasites, and the associated raised interferon levels and IgE antibodies may also have contributed to the original clinical picture. Later studies of the diseases, including those of laboratory acquired infections, have rather put emphasis on neurological complications such as severe headache, neck stiffness, coarse tremors, abnormal reflexes and mental disturbances. Mortality in KFD is approximately 5–10%.

Diagnosis and Control

The virus can be readily isolated from patients' blood using mice or cell culture, and antibodies can be detected by HI, CF, NT or ELISA tests. Vector control programmes have been carried out in the forest, especially spraying in the vicinity of dead monkeys when these are encountered. A formalin-inactivated vaccine has been prepared in India and immunization programmes in villages in the affected areas have been carried out.

POWASSAN VIRUS

Viral Features and Host Range

Powassan virus (POW) is named after the town of Powassan in northern Ontario where the first human virus isolate was made from a fatal encephalitis case in a 5-year-old boy. The disease is rare, fewer than 50 cases having been reported worldwide. Case reports have come from Canada and the United States as well as Russia.

Epidemiology

A number of arthropod vectors have yielded isolates of the virus. In North America the major vector has been *Ixodes cookei*, with *Dermacentor andersoni*, *Ixodes marxi* and *Ixodes spinipalpus*, and in Russia *Haemaphysalis neumanni*, *Ixodes persulcatus* and *Dermacentor silvarum*, occasionally being infected. In addition, infected mosquito species, *Ae. togoi* and *Anopheles hryanus* have also been reported. Vertebrates infected with POW have occurred mainly in mammals, but also birds, amphibians and reptiles.

Clinical Features

Clinical cases of POW have presented with encephalitis, meningoencephalitis and aseptic meningitis. In some cases focal encephalitic signs have occurred and in one case from Russia the patient died following bulbar paralysis. In a series of 19 cases in North America, two deaths occurred in the acute illness phase.

REFERENCES

- Anderson, S.G. (1954) Murray Valley encephalitis and Australian disease. *Journal of Hygiene*, **52**, 447.
- Anonymous (1980) *Guide for Diagnosis, Treatment and Control of Dengue Haemorrhagic Fever*, 2nd ed. Technical Advisory Committee on DHF for the Southeast Asian and Western Pacific Regions, World Health Organization, Geneva.
- Besselaar, T.G. and Blackburn, N.K. (1988). Antigenic analysis of West Nile virus strains using monoclonal antibodies. *Archives of Virology*, **99**, 75–88.
- Bharadwaj, M., Prakash, V., Mathur, A. *et al.* (1991) Prognostic significance of serum iron levels in cases of Japanese encephali-

- tis. *Postgraduate Medical Journal*, **67**, 247–249.
- Cecilia, D. and Gould, E.A. (1991) Nucleotide changes responsible for loss of neuroinvasive-ness in Japanese encephalitis virus neutralization-resistant mutants. *Virology*, **181**, 70–77.
- Centers for Disease Control (1990). Yellow fever vaccine. Recommendations of the Immunization Practices Advisory Committee (ACIP). *Morbidity and Mortality Weekly Report*, **39**, 1–6.
- Centers for Disease Control (1991a). Dengue epidemic—Peru, 1990. *Morbidity and Mortality Weekly Report*, **40**, 145–147.
- Centers for Disease Control (1991b). St Louis encephalitis outbreak—Arkansas, 1991. *Morbidity and Mortality Weekly Report*, **40**, 605–607.
- Chen, W.R., Tesh, R.B. and Rico-Hesse, R. (1990) Genetic variation of Japanese encephalitis virus in nature. *Journal of General Virology*, **71**, 2915–2922.
- Gresikova, M., Thiel, W., Batikova, M. *et al.* (1973) Haemagglutination-inhibition antibodies against arboviruses in human sera from different regions in Steiermark (Austria). *Zentralblatt für Bakteriologie, Parasitenkunde, Infektionskrankheiten und Hygiene; Erste Abteilung: Originale*, **224**, 298.
- Gubler, D.J. and Costa-Valez, A. (1991). A program for prevention and control of epidemic dengue and dengue hemorrhagic fever in Puerto Rico and the US Virgin Islands. *Bulletin of PAHO*, **25**, 237–247.
- Halstead, S.B. (1981) Arboviruses of the Pacific and South-East Asia. In *Textbook of Paediatric Infectious Diseases* (eds R.D. Feigin and J.D. Cherry), p. 1132. W.B. Saunders, Philadelphia.
- Halstead, S.B. (1984) Selective primary health care: strategies for control of disease in the developing world. XI. Dengue. *Reviews of Infectious Diseases*, **6**, 251.
- Halstead, S.B. (1989) Antibody, macrophages, dengue virus infection, shock, and hemorrhage: a pathogenic cascade. *Reviews of Infectious Diseases*, **11** (suppl. 4), S830–S839.
- Iversson, L.B. (1980) Aspects of the encephalitis epidemic caused by arbovirus in the Ribeira Valley, Sao Paulo, Brazil, during 1975–1978. *Revista de Saude Publica*, **14**, 9–35.
- Jacobs, M.G., Brook, M.G., Weir, W.R.C. *et al.* (1991) Dengue haemorrhagic fever: a risk of returning home. *BMJ*, **302**, 828–829.
- Jelinkova-Skalova, E., Tesarova, J., Buresova, V. *et al.* (1974) Laboratory infection with virus of Omsk haemorrhagic fever with neurological and psychiatric symptomatology. *Ceskoslovenska Epidemiologie, Mikrobiologie, Immunologie (PRAHA)*, **23**, 290–293.
- Jennings, A.D., Gibson, C.A., Miller, B.R. *et al.* (1994) Analysis of a yellow fever virus isolated from a fatal case of vaccine-associated human encephalitis. *Journal of Infectious Diseases*, **169**, 512–518.
- Konishi, E., Pincus, S., Fonseca, B.A.L. *et al.* (1991) Comparison of protective immunity elicited by recombinant vaccinia viruses that synthesize E or NS1 of Japanese encephalitis virus. *Virology*, **185**, 401–410.
- Kurane, I., Mady, B.J. and Ennis, F.A. (1991) Antibody-dependent enhancement of dengue virus infection. *Reviews in Medical Virology*, **1**, 211–221.
- Monath, T.P. (ed.) (1980) *Epidemiology in St Louis Encephalitis*, chap. 6. American Public Health Association, Washington DC.
- Nothdurft, H.D., Jelinek, T., Marschang, A. *et al.* (1996) Adverse reactions to Japanese encephalitis vaccine in travellers. *Journal of Infection*, **32**, 119–122.
- Ogata, A., Nagashima, K., Hall, W.W. *et al.* (1991) Japanese encephalitis virus neurotropism is dependent on the degree of neuronal maturity. *Journal of Virology*, **65**, 880–886.
- Pavri, K. (1989) Clinical, clinicopathologic and hematologic features of Kyasanur forest disease. *Reviews of Infectious Diseases*, **11**, S854–S859.
- Rodrigues, R.M. (1984) *Epidemiology of Japanese encephalitis in India*. In *National Conference on Japanese Encephalitis, 1982*. Indian Council of Medical Research Publication.
- Rosen, L. (1986) The pathogenesis of dengue haemorrhagic fever. *South African Medical Journal* (suppl.), 40–42.
- Ruff, T.A., Eisen, D. and Fuller, A. (1991) Adverse reactions to Japanese encephalitis vaccine. *Lancet*, **338**, 881–882.
- Sharma, S., Mathur, A., Prakash, V. *et al.* (1991) Japanese encephalitis virus latency in peripheral blood lymphocytes and recurrence of infection in children. *Clinical and Experimental Immunology*, **85**, 85–89.
- Shiu, S.Y.W., Morikawa, S., Buckley, A. *et al.* (1991) 17D yellow fever vaccine virus envelope protein expressed by recombinant baculovirus is antigenically indistinguishable from authentic viral protein. *Journal of General Virology*, **72**, 1451–1454.
- Smith, D.B., Pathirana, S., Davidson, F. *et al.* (1997) *Journal of General Virology*, **78**, 321–328.
- Stephenson, J.R. (1988) Flavivirus vaccines. *Vaccine*, **6**, 471–482.
- World Health Organization (1990) Yellow fever in 1988. *Weekly Epidemiological Record*, **65**, 213–220.
- World Health Organization (1991) Yellow fever—epidemic in Cameroon, 1990. *Weekly Epidemiological Record*, **66**, 76–77.
- World Health Organization (1996a) Inclusion of yellow fever vaccine in the EPI. *Weekly Epidemiological Record*, **71**, 181–185.
- World Health Organization (1996b) Yellow fever in 1994 and 1995. *Weekly Epidemiological Record*, **71**, 313–318.

Bunyaviridae

Robert Swanepoel

University of Witwatersrand, Sandringham, South Africa

INTRODUCTION

At present the family *Bunyaviridae* comprises approximately 300 animal viruses assigned to four genera: *Bunyavirus* (named after *Bunyamwera virus*), *Phlebovirus* (named after phlebotomus/sandfly fever), *Nairovirus* (named after Nairobi sheep disease) and *Hantavirus* (named after *Hantaan virus*). A further 44 inadequately characterized animal viruses are considered possible members of the family and there is a genus of plant viruses (Karabatsos, 1985; Calisher and Karabatsos, 1989; Peters and LeDuc, 1991; Calisher, 1991; Murphy *et al.*, 1995). Most of the animal viruses were discovered in the course of surveys on haematophagous arthropods or wild vertebrates, and the fact that new members of the family are constantly being encountered has been interpreted to indicate that many remain to be discovered (Peters and LeDuc, 1991). Some of the viruses are important pathogens of humans or livestock, but the majority have no known medical or veterinary significance. Sometimes a pathogenic role is discovered for a virus years after its initial isolation. Although most members of the family are thought to be arthropod-borne (i.e. arboviruses), transmission by vectors has been demonstrated conclusively in comparatively few instances. Members of the rodent-associated *Hantavirus* genus are not considered to be arthropod-borne.

The origins of the family can be traced to the initial detection of close antigenic relationships within certain groups of viruses, including one containing *Bunyamwera virus* (Casals, 1957; 1961;

Casals and Whitman, 1960; 1961). Subsequently the demonstration of weak serological cross-reactions between the groups resulted in the viruses being included in a Bunyamwera supergroup (Anonymous, 1967). The family *Bunyaviridae*, containing a single genus *Bunyavirus*, was erected when members of the supergroup and certain ungrouped viruses were found to have similar morphology (Murphy *et al.*, 1973; Porterfield *et al.*, 1974; Fenner, 1976), and later *Phlebovirus*, *Uukuvirus*, *Nairovirus* and *Hantavirus* genera were added to the family as morphological and biochemical affinities between the viruses became evident (Bishop *et al.*, 1980; Matthews, 1981; Schmaljohn *et al.*, 1985). Most recently, the uukuviruses were reduced to a serogroup within the *Phlebovirus* genus since they were found to share coding and replication strategies with the phleboviruses (Simons *et al.*, 1990; Calisher, 1991). Within genera members are still classified on the basis of antigenic affinities and they are arranged in serogroups, antigenic complexes, viruses (or serotypes), subtypes and varieties, in order of increasing relatedness, i.e. members of a genus may only exhibit distant antigenic relationship to each other, whereas differences between varieties of a virus are consistent but minimal. However, the concept of classification of viruses by serotype has had to be revised with respect to agents which fail to grow in laboratory culture systems, with greater emphasis being placed on the definition of genotypes through nucleotide sequencing of the genome. This applies particularly to recently discovered hantaviruses (Monroe *et al.*, 1999).

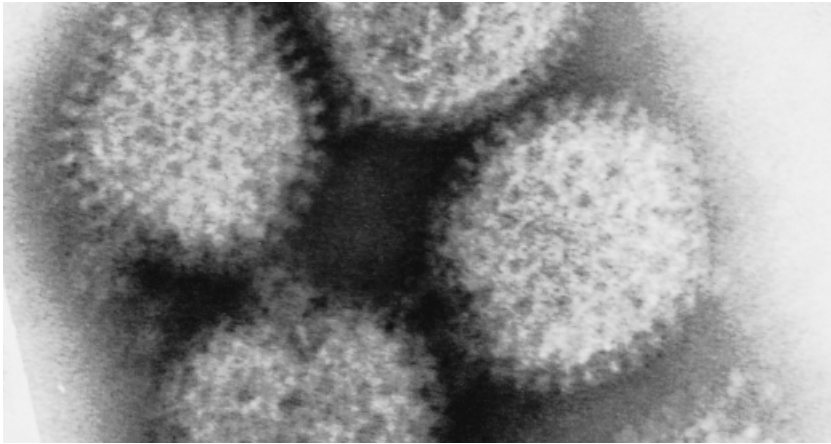

Figure 18.1 Negatively stained Rift Valley Fever virus particles from a patient's serum. Note the surface spikes around the equator of these virions, the diameter of which is 90–100 nm. ($\times 300\,000$)

Table 18.1 Major biochemical properties of members of the *Bunyaviridae*. Information derived from sources cited in the text

Viruses	Molecular weights of major structural proteins ($\times 10^3$)			Molecular weights of RNA species ($\times 10^6$)		
	G1	G2	N	L	M	S
Bunyaviruses	108–120	29–41	19–26	2.7–3.1	1.8–2.3	0.3–0.5
Sandfly fever group	55–70	50–60	20–30	2.6–2.8	1.8–2.2	0.7–0.8
Uukuniemi group	70–75	65–70	20–25	2.0–2.5	1.0–1.3	0.4–0.7
Nairoviruses	72–84	30–40	48–54	4.1–4.9	1.5–2.3	0.6–0.7
Hantaviruses	64–76	52–58	48–54	2.2–2.9	1.2–2.9	0.6–0.75

THE VIRUS

Structure

The viruses of the family are spherical, 80–120 nm in diameter, and have a host cell-derived bilipid-layer envelope through which virus-coded glycoprotein spikes or peplomers project (Figure 18.1). The virions contain three major structural proteins: two envelope glycoproteins, G1 and G2, and a nucleocapsid protein N, plus minor quantities of a large or L protein ($145\text{--}259 \times 10^3$ Da) believed to be the viral transcriptase, an RNA-dependent RNA polymerase (Table 18.1) (Bishop, 1990; Schmaljohn and Patterson, 1990; Peters and LeDuc, 1991; Calisher, 1991). (*Hazara virus* of the genus *Nairovirus* is believed to have three glycoproteins.) Members of the family have a three-segmented, single-stranded RNA genome and each of the segments, L (large), M

(medium) and S (small), is contained in a separate nucleocapsid within the virion. The sizes of the structural proteins and RNA segments vary with genus (Table 18.1). The genomic RNA is in the negative-sense (complementary to mRNA), but the S segment of the Phlebovirus genome consists of ambisense RNA, i.e. has bi-directional coding, a property which is shared only with the RNA of viruses of the family *Arenaviridae*. The first 8–13 nucleotide bases at the 3' ends of the RNA segments tend to have a sequence which is conserved within the viruses of each genus, with a complementary (palindromic) consensus sequence occurring at the 5' end; and the ends of the segments are non-covalently linked so that the RNA occurs in a loosely bound circular configuration within the nucleocapsids. The segmented nature of the genome suggests that the potential exists for reassortment to occur in coinfections, and it is thought that this mechanism may have contributed to the evolution

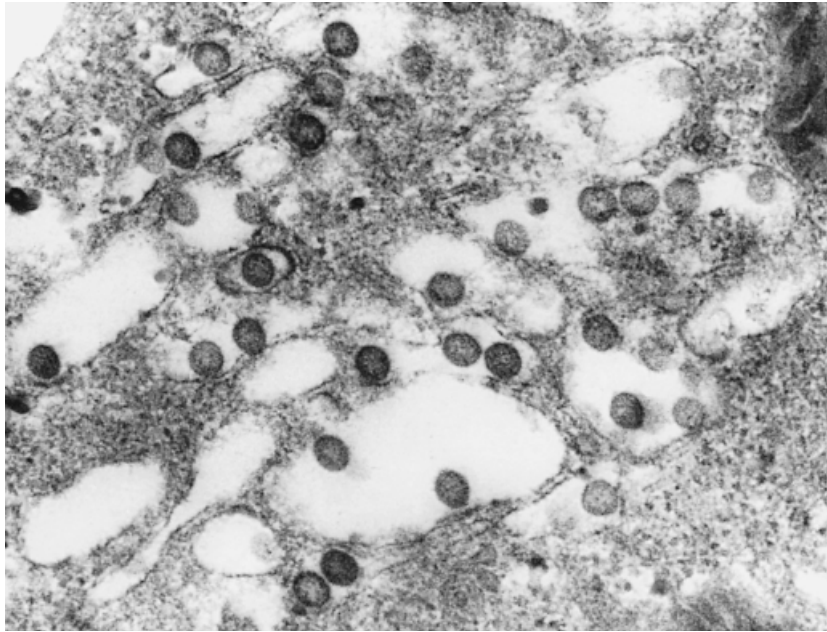

Figure 18.2 Rift Valley fever viruses maturing within host cell vacuoles ($\times 37\,500$)

of diversity in the family, but experimental evidence indicates that there are genetic restraints and that reassortment occurs with facility only between closely related members of bunyavirus serogroups or different strains of an individual phlebovirus (Peters and LeDuc, 1991).

The L RNA segment of the genome codes for the viral transcriptase, and the M segment for the G proteins, as well as a non-structural protein NS_m in the *Bunyavirus* and *Phlebovirus* genera. The S segment RNA codes for the N protein, as well as a non-structural protein NS_s in the bunyaviruses and phleboviruses. Non-structural proteins have not as yet been demonstrated in the nairoviruses or hantaviruses. The viral glycoproteins are responsible for recognition of receptor sites on susceptible cells, manifestation of viral haemagglutinating ability and for inducing protective immune response in the host. The N protein induces production of and reacts with complement-fixing antibody.

Biological Characteristics

Viruses which attach to receptors on susceptible cells are internalized by endocytosis, and replication occurs in the cytoplasm. Virions mature pri-

marily by budding through endoplasmic reticulum into cytoplasmic vesicles which are presumed to fuse with the plasma membrane to release virus, but it appears that virus can also bud directly from the plasma membrane (Figure 18.2) (Anderson and Smith, 1987). Most of the viruses have been isolated and propagated by intracerebral inoculation of suckling mice, but the hantaviruses produce chronic and inapparent infection of laboratory rodents. Members of the family can be grown in a variety of cell cultures (Vero cells have been used most commonly), but some of the viruses are non-cytolytic so that their presence has to be demonstrated by immunofluorescence or similar means. Hantaviruses are difficult to grow *in vitro*, and several of the more recently discovered members of the genus have not yet been adapted successfully to cell cultures (Monroe *et al.*, 1999).

An abridged classification of the family, showing selected members known to cause infection of humans and livestock in relation to their vectors and distribution, is presented in Tables 18.2–18.6 (Karabatsos, 1985; Calisher and Karabatsos, 1989; Peters and LeDuc, 1991; Calisher, 1991). In addition, high prevalences of antibody to many other viruses have been found in particular human populations, but conclusive evidence of infection or disease association is lacking: antigenic cross-

Table 18.2 Abridged classification of the genus *Bunyavirus* showing members known to cause infection of humans and domestic animals. Information derived from sources cited in the text

Serogroup ANTIGENIC COMPLEX Virus (Synonym) Subtype Variety	Putative vectors vectors	Human infection		Livestock	Distribution
		Natural	Laboratory		
Bunyamwera	Mosquitoes	+	+		Africa
BUNYAMWERA (21)^a					
<i>Bunyamwera</i>					
<i>Batai (Calovo)</i>	Mosquitoes	+			Europe, Asia
<i>Cache Valley</i>	Mosquitoes	+		+	N. America
<i>Maguari</i>	Mosquitoes	+		?	S. America
<i>Fort Sherman</i>	Mosquitoes?	+			C. America
<i>Germiston</i>	Mosquitoes		+		Africa
<i>Ilesha</i>	Mosquitoes	+			Africa
<i>Shokwe</i>	Mosquitoes	+			Africa
<i>Tensaw</i>	Mosquitoes	+			N. America
WYEOMYIA (8)					
<i>Wyeomyia</i>	Mosquitoes	+			C. and S. America
Three other complexes (3)					
Anopheles A					
TACAIUMA (6)					
<i>Tacaiuma</i>	Mosquitoes	+			S. America
One other complex (6)					
Anopheles B: one complex (2)					
Bakau: one complex (5)					
Bwamba					
BWAMBA (2)					
<i>Bwamba</i>	Mosquitoes	+			Africa
<i>Pongola</i>	Mosquitoes	+			Africa
Group C					
CARAPARU (5)					
<i>Caraparu</i>	Mosquitoes	+	+		C. and S. America
<i>Ossa</i>	Mosquitoes	+	+		C. America
<i>Apeu</i>	Mosquitoes	+	+		S. America
MADRID (1)					
<i>Madrid</i>	Mosquitoes	+			C. America
MARITUBA (6)					
<i>Marituba</i>	Mosquitoes	+	+		S. America
<i>Murutucu</i>	Mosquitoes	+	+		S. America
<i>Restan</i>	Mosquitoes	+			S. America
<i>Nepuyo</i>	Mosquitoes	+			C. and S. America
ORIBOCA (2)					
<i>Oriboca</i>	Mosquitoes	+	+		S. America
<i>Itaqui</i>	Mosquitoes	+			S. America
California					
CALIFORNIA ENCEPHALITIS (6)					
<i>California encephalitis</i>	Mosquitoes	+			N. America
<i>Inkoo</i>	Mosquitoes	+			Europe
<i>La Crosse</i>	Mosquitoes	+	+	+	N. America
<i>Snowshoe hare</i>	Mosquitoes	+			N. America
<i>Tahyna (Lumbo)</i>	Mosquitoes	+			Europe, Asia, Africa
MELAO (7)					
<i>Jamestown Canyon</i>	Mosquitoes	+			N. America
<i>Keystone</i>	Mosquitoes		+		N. America

Table 18.2 (cont.)

Serogroup ANTIGENIC COMPLEX Virus (Synonym) Subtype Variety	Putative vectors vectors	Human infection		Livestock	Distribution
		Natural	Laboratory		
		GUAROA (1) <i>Guaroa</i>	Mosquitoes		
One other complex (1) Capim: five complexes (10) Gamboa: two complexes (8) Guama					
GUAMA (4) <i>Guama</i>	Mosquitoes	+			C. and S. America
CATU (1) <i>Catu</i>	Mosquitoes	+	+		S. America
Three other complexes (7) Koongol: one complex (2) Minatitlan: one complex (2) Nyando					
NYANDO (2) <i>Nyando</i>	Mosquitoes	+			Africa
Olifantsvlei: two complexes (5) Patois: two complexes (7) Simbu					
AKABANE (2) <i>Akabane</i>	Ceratopogonids			+	Asia, Africa, Australasia
MANZANILLA (12) <i>Oropouche</i>	Ceratopogonids	+	+		S. America
<i>Tinaroo</i>	<i>Ceratopogonids</i>			+	<i>Australasia</i>
SHUNI (3) <i>Shuni</i>	Ceratopogonids	+		+	Africa
<i>Aino</i>	Ceratopogonids			+	Asia, Australasia
Four other complexes (8) Tete: one complex (6) Turlock: two complexes (5) Ungrouped (4)					

^aFigures in parentheses indicate the total numbers of recognized members of the relevant taxon.

reactivity between viruses can complicate the interpretation of survey findings or render it difficult to arrive at a serological diagnosis in individual cases of disease.

There is a broad tendency for antigenic grouping to correlate with geographic distribution and with the type of vector involved in transmission (Tables 18.2-18.4). Although a greater variety of arthropod-borne members occurs in tropical and subtropical countries of Latin America and Africa, many viruses, including several important pathogens, occur in temperate countries and the distribution of the family extends to the Arctic region. Moreover, there are many instances on record of residents of temperate countries which lack indigenous disease, acquiring infection during travels abroad. Most of the

viruses appear to be transmitted by culicine mosquitoes including aedines, but some are transmitted by anopheline mosquitoes. Simbu serogroup viruses are associated particularly with ceratopogonid midges (*Culicoides* spp.), while the sandfly fever serogroup of phleboviruses (apart from Rift Valley fever and a few other mosquito-borne viruses), are associated with phlebotomids (sandflies). The Tete serogroup of bunyaviruses, Uukuniemi serogroup of phleboviruses and the nairoviruses are associated with ixodid and argasid ticks. Some viruses have been isolated from more than one type of vector.

Transmission

It is characteristic of arthropod-borne viruses that they produce viraemia in at least one species of vertebrate to allow the infection to be acquired by biological vectors which take blood meals. During a so-called extrinsic incubation period, commonly lasting 1–2 weeks in dipterid vectors (mosquitoes, midges and sandflies), the virus replicates in the vector and spreads to produce infection of the salivary glands, thereby permitting transmission to occur to a second vertebrate host. Virus is thus maintained by circulation between the vector and a vertebrate host. The maintenance cycle may be cryptic, involving wild vertebrates which develop inapparent infection, with incidental spread of infection to susceptible domestic animals or humans which impinge on the cycle. It has been postulated that through selection pressure brought about by long association with the virus, natural maintenance hosts often develop transient viraemic infection without displaying susceptibility to the pathogenic effects of the virus concerned. Small mammals and birds which occur in large numbers, breed prolifically to ensure a constant supply of non-immune individuals, and are subject to periodic population explosions, constitute ideal maintenance hosts for arboviruses. Species susceptible to disease may themselves serve to amplify circulation of virus through infecting vectors, but humans serve this purpose for members of the *Bunyaviridae* in few instances only (Oropouche, sandfly fever), and are usually 'dead-end' hosts. Domestic animals which develop disease or undergo inapparent infection may serve as link hosts between the natural cycle and humans, which in turn gain infection from contact with infected tissues of livestock or products such as milk, or from vectors infected by feeding on livestock (Rift Valley fever, Crimean-Congo haemorrhagic fever (CCHF)).

Since the biting activity of arthropod vectors, and hence the infection of vertebrates, is seasonal, the fate of arthropod-borne viruses during winters or dry seasons of inactivity has long constituted a central enigma in the epidemiology of arbovirus diseases. Many plausible mechanisms for overwintering or hibernation of arboviruses have been described, including persistent infection of vertebrates, migration of infected birds or mammals, hibernation of infected adult vectors, and continu-

ous vector activity in tropical locations (Reeves, 1974). Transovarial transmission of infection in arthropod vectors, however, theoretically constitutes an ideal mechanism for ensuring the perpetuation of the viruses, and comparatively early in the history of the investigation of arbovirus diseases convincing evidence was produced to indicate that the phenomenon occurs in phlebotomids and ixodid ticks (Tesh, 1984). The evidence for mosquito-borne viruses long remained in doubt, but in recent years many investigators have demonstrated transovarial transmission of bunyaviruses, particularly members of the California encephalitis serogroup, as well as *Rift Valley fever virus* and members of the *Togaviridae* and *Flaviviridae* families in mosquitoes (Tesh, 1984; Linthicum *et al.*, 1985; Peters and LeDuc, 1991; Swanepoel, 1994). Even in the absence of transovarial transmission of infection, the overwintering of viruses transmitted by ixodid ticks can be explained by the long intervals which occur between the feeding of successive instars of the vectors.

In general, viruses transmitted by dipterid flies (mosquitoes, midges and sandflies) may cause sporadic infections but are capable of causing explosive epidemics at irregular intervals of years when climatic conditions are particularly favourable for the breeding of vectors, or human manipulation of the environment results in large scale juxtaposition of susceptible persons or livestock and vectors. Viruses transmitted by ixodid ticks tend to cause sporadic disease in locations where there is occupational or recreational exposure of humans to ticks, but human intervention can precipitate the occurrence of larger outbreaks of disease.

Clinical syndromes associated with members of the *Bunyaviridae* range from inapparent infections known from routine monitoring of laboratory workers, through moderate to severe influenza-like illness with or without a maculopapular rash and characterized by fever (often biphasic), headache, myalgia, arthralgia and malaise, to encephalitis or haemorrhagic disease with necrotic hepatitis, while the hantaviruses of Asia and Europe are associated with a group of diseases known collectively as haemorrhagic fever with renal syndrome (HFRS), and recently discovered hantaviruses of the Americas are associated with an acutely fatal respiratory disease known as hantavirus pulmonary syndrome (HPS). The information presented below on the epidemiology and disease associations of individual viruses is derived from a few collated sources, except

where indicated otherwise (Karabatsos, 1985; Calisher and Karabatsos, 1989; Porterfield, 1990; Gonzalez-Scarano and Nathanson, 1990; Peters and LeDuc, 1991; McKee *et al.*, 1991).

LABORATORY DIAGNOSIS

The appropriate specimens and laboratory methods required for confirming diagnoses of the more important diseases are indicated in the relevant sections dealing with the individual infections below. Procedures developed and applied over decades for the isolation and identification of arthropod-borne members of the family, or for demonstrating immune responses, remain valid (Shope and Sather, 1979). However, there are residual problems concerning the sensitivity, specificity and rapidity with which certain infections can be diagnosed, and these are being solved through increasing utilization of newer serological and molecular biological techniques. Isolation and identification of virus remains the definitive way of making a diagnosis, and this is especially true for what is perceived as a novel or as an undifferentiated febrile illness: it is easier to arrive at a serological diagnosis in diseases which are recognizable from their clinical presentation or from the circumstances under which patients become infected, such as Oropouche fever, sandfly fever, CCHF, Rift Valley fever, or HFRS. Sporadic undifferentiated febrile illnesses, in contrast, have usually been identified in the course of surveys, and the diagnosis of individual cases requires clinical acumen and recourse to the services of a specialized laboratory able to screen for a range of viruses known or considered likely to occur in the area where the infection was acquired.

Virus Detection and Identification

Most members of the family were discovered through intracerebral inoculation of suckling mice, and this method is still widely used for isolating the viruses. A few of the viruses are also pathogenic for weaned mice or hamsters, some even by peripheral route, and this constitutes a useful screening method for preliminary identification of isolates, e.g. *Rift Valley fever virus*. Some viruses which are non-pathogenic for laboratory rodents, such as the

hantaviruses (not known to be arthropod-borne), can nevertheless be isolated in rodents through demonstrating the presence of viral antigens in tissues. Many cytopathic, as well as non-cytopathic viruses such as CCHF, can be isolated in mammalian cell cultures and detected by immunofluorescence. The method has the advantage that it is usually rapid, and therefore clinically useful, but it is not invariably more sensitive than the use of suckling mice for isolating viruses which are present in low concentrations in pathological specimens. Certain viruses which are non-pathogenic for laboratory mice, such as some of the neotropical phleboviruses, were only discovered because they proved to be cytopathic in mammalian cell cultures. Although it has not been proven for members of the *Bunyaviridae*, some arboviruses can be isolated most successfully by inoculation of mosquito cell cultures, which do not manifest cytopathic effect, or live mosquitoes, and in these instances the isolation of virus has to be demonstrated by immunological means.

In some diseases, such as Rift Valley fever or CCHF, rapid diagnoses can sometimes be achieved without culturing virus, by demonstrating the presence of viral antigens directly in infected blood or other tissues by enzyme-linked immunoassay, immunofluorescence or a variety of other immunological methods. This approach was used in the discovery hantaviruses in rodent tissues. In certain diseases, such as La Crosse encephalitis, it appears that virus is seldom present in blood or other tissues in infective concentrations at the time that the disease is recognized, while other viruses, such as the hantaviruses, appear to be present but are extremely difficult to isolate and adapt to laboratory host systems. An alternative is to detect viral nucleic acids in tissue extracts or histological sections by hybridization with specific radio-labelled nucleic acid probes. A more sensitive technique is to use reverse transcription and the polymerase chain reaction to detect viral nucleic acids, and this has been used with notable success on blood and other tissues of human patients and rodents infected with hantaviruses. A further advantage of the technique is that it may be possible to select consensus sequence primers which are specific for either individual viruses, groups of viruses or all potential members of a genus (Puthavathana *et al.*, 1992; Arthur *et al.*, 1992; Nichol *et al.*, 1993; Xiao *et al.*, 1994; Monroe *et al.*, 1999).

Isolates are generally identified by serological

means, and by definition viruses react most specifically with antisera in neutralization tests, but these are technically difficult to perform with some viruses, or may not yield results sufficiently rapidly to be clinically useful. Antisera tend to be more cross-reactive in the other serological tests commonly used for the investigation of the *Bunyaviridae*, namely, complement-fixation, haemagglutination-inhibition, immunofluorescence and enzyme-linked immunoassay, and this is particularly true within serogroups of the genus *Bunyavirus*. The problem can be overcome, and the process accelerated, by using monoclonal antibodies to achieve simultaneous detection and identification of isolates, as in immunofluorescence tests on cell cultures. In instances where potentially new viruses, or viruses associated with undifferentiated illnesses, have to be identified, cross-reactivity can be useful. Unidentified isolates may have to be tested against antisera to all of the known viruses of the region involved, or even ultimately against antisera to hundreds of viruses which occur elsewhere in the world, and the process is facilitated by preliminary screening of the isolates with pools of antisera, or antisera which have deliberately been rendered cross-reactive by immunizing laboratory animals sequentially with several viruses. Morphological or partial biochemical characterization of isolates, by performance of electronmicroscopic examination or tests for sensitivity to ether and bile salts, for instance, may also facilitate the process of identifying a virus.

In instances where viral nucleic acids have been detected, these can be identified by hybridization under stringent conditions with labelled probes which are specific for individual viruses, or by demonstrating specific endonuclease restriction enzyme digestion patterns with the products of a polymerase chain reaction. However, it is becoming more common to perform nucleotide sequencing on the products of polymerase chain reactions to obtain more exact information on the phylogenetic relationships of the etiological agents concerned (Monroe *et al.*, 1999).

Serology

Serological diagnosis of infections is beset with the same problems of cross-reactivity which apply to antigenic identification of isolates, and the difficul-

ties are compounded where patients have previously been infected with an antigenically related virus: antibody response tends to be broadly cross-reactive within serogroups following sequential infections. Neutralizing antibody, which reacts most specifically for individual viruses, usually becomes demonstrable by day seven to 10 of illness (earlier in Rift Valley fever) and after an initial postconvalescent decline in titre, tends to remain demonstrable for life, but the response is usually weak and difficult to demonstrate following nairovirus infections. Complement-fixing antibody becomes demonstrable in the second or third week of illness, declines after several months, and tends to be group-specific with bunyaviruses and nairoviruses, but more specific among phleboviruses. Antibody demonstrable by haemagglutination-inhibition, indirect immunofluorescence or enzyme-linked immunoassay becomes detectable at about the same time as neutralizing antibody, and after a postconvalescent decline in titre, remains demonstrable for at least a period of several years, and varies in specificity in different groups of viruses. Demonstration of IgM antibody activity in indirect immunofluorescence tests or enzyme-linked immunoassays is most useful for establishing a rapid diagnosis. Antibody titres tend to be highest against the homologous infecting virus, so that problems of cross-reactivity can sometimes be overcome by screening patients' sera with a range of antigens prepared from all members of the virus serogroup known to occur in the area concerned, as is done with members of the California encephalitis serogroup. An alternative is the preparation of purified antigens which contain virus proteins or peptides which react specifically with serotype antibody, and this includes preparation of antigens by recombinant DNA technology (Feldmann *et al.*, 1993). The same effect may be obtained by selective capture of viral proteins with monoclonal coating antibody in enzyme-linked immunoassays.

GENUS *BUNYAVIRUS*

Serogroup Bunyamwera

Bunyamwera, Ilesha, Germiston and Shokwe viruses

Bunyamwera virus is widely distributed in Africa

and has been isolated from aedines and other culicine mosquitoes, and/or human blood in Uganda, South Africa, Kenya, Nigeria, Central African Republic, Cameroon and Senegal. Antibody has been found in humans and/or domestic animals, rodents, bats and subhuman primates in the same countries as well as in Mozambique, Tanzania, Angola, Congo, Egypt and Tunisia. However, some of the antibody reactions recorded in surveys may have been due to infection with related viruses. Despite the widespread occurrence of antibody, human disease has seldom been recognized and the few cases which have been described include several laboratory infections. Clinical findings included fever, maculopapular rash, arthralgia, neck stiffness, vertigo and temporary loss of visual acuity. Severe encephalitis occurred in experimental infection of a tumour patient. Infection was confirmed in patients by isolation of virus from blood or demonstration of an immune response. It seems likely that disease may be more common than at present realized.

Ilesha virus has been isolated from the blood of febrile humans in Nigeria, Uganda, Cameroon, and the Central African Republic, and from anopheline mosquitoes in the latter country. In addition there is serological evidence that the virus occurs in Senegal and Ghana. Few cases of disease have been reported, and these consisted of undifferentiated febrile illness with a rash. *Shokwe virus* has been isolated from mosquitoes, mainly aedines but also from other culicines in South Africa, Senegal, Ivory Coast and Kenya, and from rodents and the blood of a febrile human in Ivory Coast. Little is known of the pathogenic potential of the virus. *Germiston virus* has been isolated in South Africa, Zimbabwe, Mozambique, Kenya and Uganda from *Culex rubinotus*, a mosquito which selectively feeds on rodents, and from myomorph rodents (rats and mice) in Uganda. Antibody has been found in the sera of humans and/or cattle and rodents in South Africa, Botswana, Namibia and Angola. Two laboratory infections have been reported; one with undifferentiated febrile illness with rash, and the other with signs of mild encephalitis. Virus was isolated from the blood of the patients.

Batai virus

Calovo virus, first isolated from anopheline mosquitoes in 1960 in what was then Czechoslovakia, is believed to be closely related or identical to *Batai*

virus, which had previously been isolated from culicine mosquitoes in Malaysia in 1955. Furthermore, the name Olyka was provisionally used for *Batai virus* isolated from mosquitoes in the Ukraine, and Chittoor virus isolated from anophelines in India is also considered to be closely related or identical to *Batai virus*. Altogether, the cluster of viruses has been isolated from anopheline and culicine mosquitoes in Malaysia, Thailand, Cambodia, India, Yugoslavia, Austria and the former USSR and Czechoslovakia. Antibody has been found in the same countries, as well as in Sri Lanka, Roumania, Hungary, Germany, Portugal and Finland in the sera of humans and/or birds, rodents, domestic ruminants and deer. The findings in seroprevalence studies suggest that human infection is seldom accompanied by overt disease, but febrile illness with malaise, myalgia, anorexia, and sometimes abdominal pain, tonsillitis, cough and dyspnoea (associated with lung infiltration), has been reported from Czechoslovakia and Malaysia on the basis of serological diagnoses.

Cache Valley, Maguari, Fort Sherman, Tensaw and Wyeomyia viruses

Cache Valley virus has been isolated from culicine and anopheline mosquitoes from widely separated locations in the USA and from Jamaica, and antibody has been found in the sera of humans and/or horses, sheep, cattle, wild rodents, raccoons, deer and monkeys in the USA, Canada, Trinidad and Guyana. Despite the occurrence of high antibody prevalence rates, human disease has not been reported. Recently, however, the results of serological studies and pathogenicity trials, and the isolation of virus from a sentinel sheep, incriminated *Cache Valley virus* as the causative agent of an outbreak of congenital abnormalities (hydranencephaly-arthrogryposis syndrome) among sheep in Texas (Chung *et al.*, 1990a; 1990b). *Maguari*, a subtype of *Cache Valley virus*, has been isolated from mosquitoes, mainly aedines, in Brazil, Argentina, French Guiana, Colombia and Trinidad, and from horse blood in Guyana and Colombia. Antibody has been found in the same countries as well as in Peru, Surinam and Venezuela in the sera of humans and/or horses, cattle, sheep, water buffalo and birds. Human disease has not been reported, but the virus is suspected of causing disease in horses. *Fort Sherman*, yet another subtype of *Cache Valley virus*, was

isolated from the blood of a patient with fever, malaise, myalgia and sore throat in Panama, but no further information on the virus is available. *Tensaw virus* has been isolated from several species of anophelines in south-eastern USA, where antibody has been found in humans, dogs, cattle and raccoons. A single case of encephalitis was reported in 1973. *Wyeomyia virus* has been isolated from a range of culicine mosquitoes in Colombia, Panama, French Guiana and Trinidad, and antibody has been found in human sera in Panama and Trinidad. The virus has been isolated once from the blood of a patient with febrile illness in Panama.

Serogroup Anopheles A

Tacaiuma virus

Tacaiuma virus was isolated from the blood of a sentinel monkey and from forest mosquitoes in the Amazon region of Brazil, as well as from mosquitoes in Argentina. Antibody has been found in humans in Brazil and French Guiana, and in horses, rodents, bats and birds in Brazil. The virus has been isolated once from the blood of a patient with febrile illness in Brazil.

Serogroup Bwamba

Bwamba and Pongola viruses

Bwamba virus was originally isolated from blood samples from nine road workers with febrile illness in Uganda, and subsequently from eight febrile patients in Nigeria, three in the Central African Republic and one in Kenya, and from anopheline mosquitoes in Uganda, Nigeria and Senegal. Antibody was found in human sera in Uganda, Tanzania, Mozambique, South Africa, Botswana, Angola, Congo, Nigeria and Guinea; generally with very high prevalence, up to 97% in some populations, and including both children and adults. Antibody was also found in donkeys and a bird in South Africa. *Bwamba virus* appears to be an important pathogen and the eight isolations in the Nigerian series represented 5% of all arbovirus isolations from febrile patients over a 7 year period, while 18 diagnoses (virological and serological) made in similar patients in the Central African Republic

represented 25% of arbovirus infections diagnosed over a 13 year period. The patients suffered prostrating illness with fever, headache, conjunctivitis, rash, epigastric pain and myalgia, and many had meningeal signs.

There have been numerous isolations of *Pongola virus* from mosquitoes, mainly aedines and other culicines, in South Africa, Mozambique, Kenya, Uganda, Ethiopia, Central African Republic and Ivory Coast. There has been one isolation of the virus from a febrile patient with headache and myalgia in Uganda (Kalunda *et al.*, 1985). Neutralizing antibody has been found in humans in South Africa, Mozambique, Botswana, Namibia and Angola, and in cattle, sheep, goats and donkeys in South Africa, but interpretation of the findings is complicated by the fact that there is unidirectional cross-neutralization of *Pongola virus* by antibody to its close relative, *Bwamba virus*. Moreover, the fact that most human isolates have reacted as Bwamba serotype while most mosquito isolates have reacted as Pongola serotype merits further investigation, particularly in view of a report that passage of a Bwamba isolate in mosquitoes led to selection of virus reacting as Pongola serotype (Johnson *et al.*, 1978).

Serogroup C

Apeu, Caraparu, Ossa, Madrid, Marituba, Murutucu, Restan, Nepuyo, Itaquí and Oriboca viruses

Apart from one virus which occurs in Florida, USA, all of the known members of serogroup C occur in Central and South America and tend to be associated with tropical forests. The viruses named above have all been isolated from the blood of febrile humans, and variously from sentinel monkeys, rodents, occasional marsupials and fruit bats, and from a range of culicine mosquitoes in Brazil, Surinam, French Guiana, Guatamala, Honduras, Trinidad, Panama or Mexico. Serological evidence suggests that some of these viruses may also occur in Venezuela, Colombia and Peru. Pairs of the viruses which are closely related antigenically may circulate in the same geographic location yet occupy separate ecologic niches. For instance, one virus circulates in arboreal monkeys and mosquitoes which feed in the canopy layer, while a

closely related virus circulates in rodents and mosquitoes which feed at the level of the forest floor. Other pairs of closely related viruses coexist in the same habitat simply by utilizing different vectors. Sporadic infections occur in persons who enter forests. No large outbreaks of disease have been reported, but disease is observed when susceptible outsiders such as military personnel enter endemic regions. Laboratory infections are relatively common. Disease, which lasts for up to a week and runs a benign course, is characterized by fever, rigors, headache, photophobia, conjunctivitis, tachycardia, myalgia, arthralgia, prostration, leucopenia and occasionally pain in the right upper quadrant of the abdomen and jaundice.

Serogroup California

California encephalitis, La Crosse, Snowshoe hare, Jamestown Canyon and Keystone viruses

California encephalitis virus, which is distributed across the western USA and into Canada, was isolated from mosquitoes in the early 1940s and shortly thereafter serological evidence was produced to indicate that it causes encephalitis. However, from the mid 1960s onwards it became clear that most cases of what are loosely termed 'California encephalitis' are in fact due to infection with the *La Crosse* subtype of virus, and that this agent is responsible for the majority of the approximately 100 cases of arbovirus encephalitis diagnosed in the USA annually, except in years when there are epidemics of St Louis encephalitis (a flavivirus).

Most cases of disease due to *La Crosse virus* are recorded in the mid-west states of Wisconsin, Iowa, Indiana, Minnesota and Ohio, but the virus is widely distributed and the infection is probably underdiagnosed elsewhere in the USA. The principal vector is *Aedes triseriatus*, a tree-hole breeding mosquito, and accordingly the virus tends to be focally distributed in woodlands, but also occurs in suburban situations where water that collects in discarded containers such as motor vehicle tyres, affords mosquito breeding sites. The virus is passed transovarially in the vector and overwinters in mosquito eggs; infection is amplified in the succeeding spring and summer in small mammals such as chipmunks and squirrels. The vector is a diurnal feeder

and the infection is seen most commonly in forest workers, and children who enter woodlands for recreational purposes, but also occurs focally in rural and suburban residents. Males are more commonly infected than females, among both children and adults. Seroprevalence surveys and prospective studies indicate that most infections are inapparent or benign. Probably less than 1% of infected adults develop encephalitis, but the incidence may be up to four times greater in young children.

After an incubation period of 3–7 days there is sudden onset of fever, headache, lethargy, nausea and vomiting, pharyngitis and sometimes respiratory illness. There is seldom a cutaneous rash. In mild cases of overt disease there may be transient meningismus and disorientation, and recovery within 1 week. In severe disease there may be greater disturbance of consciousness, aphasia, tremors, chorea, positive Babinski signs and other abnormal reflexes, and hemiparesis in about 20% of patients. Seizures may occur from the second day of illness onwards: in about half of severely ill patients there may be generalized, life-threatening convulsions, and in a further 25% there are focal convulsions associated with frontal or parietal brain lesions. Approximately one third of severely ill patients become comatose. There may be marked leucocytosis, and examination of cerebrospinal fluid reveals elevated mononuclear and polymorphonuclear cell counts, but protein and glucose levels tend to remain normal. Electroencephalograms show generalized slow-wave activity or localized changes and sometimes epileptiform discharges. Treatment is symptomatic and includes monitoring and control of intracranial pressure, and vigorous anti-convulsant therapy as indicated. Less than 1% of patients with severe disease succumb and most are discharged from hospital after about two weeks of illness, but may remain irritable and emotionally labile for a few weeks. There are seldom residua, but patients who suffer seizures in the acute illness may have recurrent convulsions over a period of 1 or more years, and lasting hemiparesis occurs in about 1% of patients. Virus has not been isolated from throat swabs, blood, stools or cerebrospinal fluid, and only with difficulty from brain specimens. Histopathological lesions are not pathognomonic and include cerebral oedema, perivascular cuffing and focal gliosis in grey matter. A variety of methods are used for making a serological diagnosis, but demon-

stration of IgM antibody activity by means of enzyme-linked immunoassay holds greatest promise as a rapid diagnostic technique. There is no vaccine.

Snowshoe hare is a mosquito-borne subtype of *California encephalitis virus* with a distribution extending from north-western USA, across most of Canada to Alaska. The natural host appears to be the snowshoe hare, *Lepus americanus*, and serological evidence suggests that the virus is occasionally associated with encephalitis in children and adults. *Jamestown Canyon* is a mosquito-borne virus which occurs widely in the USA, and high prevalence rates of antibody are found in white-tailed deer, and in humans where there are high concentrations of the deer. Serological evidence of an association with encephalitis in humans has been found from the early 1980s onwards (Grimstad *et al.*, 1986). Since antigens and tests commonly used for the serodiagnosis of 'California encephalitis' fail to allow response to *Jamestown Canyon virus* to be distinguished from response to other members of the serogroup, it is felt that the infection has probably been missed or underdiagnosed as a cause of encephalitis in the past, both in the mid-west states and elsewhere where the deer occurs. In contrast to *La Crosse virus*, *Jamestown Canyon* appears to cause encephalitis more frequently in adults than in children, and nervous disease is often preceded by respiratory illness. *Keystone virus* is associated with swamp-breeding aedines and cotton rats and rabbits in south-eastern USA, and has been known to cause inapparent accidental infection in the laboratory.

Tahyna and Inkoo viruses

Tahyna virus is widely distributed in countries of central Europe, including Yugoslavia, Germany and Italy, with antibody prevalence rates being particularly high in the Rhone Valley of France, the Danube basin in Austria, and in the southern Moravia region of the former Czechoslovakia, where up to 95% of adults may be immune in some communities. Viruses described as being *Tahyna*-like have been isolated in the former USSR, while *Lumbo virus*, which was isolated from saltwater-breeding mosquitoes on the coast of Mozambique, is considered to be indistinguishable from *Tahyna virus*. Antibody to *Tahyna virus* has also been found in southern China and Sri Lanka. It is not yet clear whether a single virus occurs throughout this range

or whether, as seems more likely, a cluster of closely related viruses, subtypes or varieties is involved.

The epidemiology of the disease has been studied most intensively in Moravia where seasonal flooding of level woodlands provides extensive breeding sites for mosquitoes. The virus is transmitted transovarially in *Aedes vexans* which overwinters as eggs, and in *Culiseta annulata* which overwinters as larvae. Amplification of infection in spring occurs in small mammals such as hedgehogs, hares and rabbits, as well as in domestic animals such as horses. Hedgehogs may themselves serve as reservoir hosts for overwintering of virus in instances where they undergo chronic infection during hibernation, with viraemia which persists for a few days after awakening. Once infection of vertebrates occurs in summer other species of mosquito also become infected and serve as vectors for transmission of the virus.

Seroprevalence surveys indicate that infection is much more common than overt disease in rural residents of Moravia. Nevertheless, the infection accounts for up to 20% of patients hospitalized with febrile illness in the region, including both adults and children. Patients may present with undifferentiated febrile illness with leucocytosis, but pharyngitis, cough, and chest pain and infiltration (demonstrable by X-ray imaging) may predominate, or gastrointestinal symptoms such as nausea, vomiting and abdominal pain may be dominant. Aseptic meningitis occurs in a minority of patients but fatal disease is unknown. Virus can be isolated from blood early in the illness, but the infection is usually diagnosed by demonstration of an antibody response. There is no vaccine.

Inkoo virus was isolated from aedine mosquitoes in Finland. Distribution of the virus extends to the Lapland region in the north of the country, and antibody occurs in the sera of humans, cattle, deer and hares. Antibody prevalence rates of up to 25% have been recorded in humans, and a few cases of febrile illness have been confirmed serologically.

Guaroa virus

Guaroa virus has been isolated from twelve febrile patients in Colombia and the Amazon region of Brazil, and from anopheline mosquitoes in Panama and Colombia. Antibody has been found in human sera in Colombia, Brazil, Argentina and Peru. Disease ascribed to infection with the virus was characterized by fever, headache, myalgia, arthralgia,

prostration and leucopenia. Virus was isolated from the blood of the patients, and from a liver biopsy in one instance.

Serogroup Guama

Guama and Catu viruses

Catu virus has been isolated from sentinel monkeys in Brazil, febrile humans and forest rodents in Brazil and Trinidad, and from culicine and anopheline mosquitoes in the same two countries plus French Guiana. *Guama virus* has been isolated from febrile humans and sentinel monkeys in Brazil, and from rodents and/or culicine mosquitoes in Brazil, Trinidad, Surinam, French Guiana and Panama. The two viruses cause isolated cases of benign disease characterized by fever, headache, myalgia and leucopenia, in persons who enter tropical forests. *Catu* has also been associated with laboratory infection.

Serogroup Nyando

Nyando virus

Nyando virus has been isolated from anopheline and aedine mosquitoes in Kenya, Central African Republic and Senegal. Antibody has been found in human sera in Kenya and Uganda, and the virus was isolated from the blood of a single human patient with biphasic fever, myalgia and vomiting in the Central African Republic.

Serogroup Simbu

Oropouche virus

Oropouche virus was originally isolated from the blood of a febrile patient in Trinidad, but large epidemics involving thousands of people have occurred exclusively in northern Brazil over the past 20 years. In addition to humans, the virus has been isolated from a sloth, a few species of culicine mosquitoes and the midge *Culicoides paraensis*. Antibody has been found in the sera of humans and/or monkeys and birds in Brazil, Trinidad and Colombia. Virus is thought to be maintained in nature by circulation in forest primates, sloths or birds and an

unidentified vector, and is introduced into urban settings by infected travellers or by extension from the sylvatic cycle. Humans serve as amplifier hosts in the urban cycle, and the vector is the *Culicoides* midge which breeds in decaying waste from tropical agricultural products. Epidemics occur when there are large concentrations of vectors and susceptible humans. Aerosol infection is suspected to have occurred in laboratory workers. The incubation period is 4–8 days, and there is sudden onset of fever, chills, headache, myalgia, arthralgia and prostration. There may be a rash, and occasionally signs of meningitis or encephalitis, but there are no deaths or sequelae. Viraemia lasts from 2 to 5 days, as does illness, but myalgia persists for a further 3–5 days, and strenuous exertion in early convalescence can precipitate a relapse of symptoms.

Akabane, Aino, Tinaroo and Shuni viruses

Most members of the Simbu serogroup do not occur in the Americas, but are widely distributed in Africa, Asia and Australasia. Of these latter viruses, only *Shuni* has been marginally implicated in causing human disease, but a few have been incriminated as causative agents in large outbreaks of abortion, stillbirth and congenital defects (hydranencephaly–arthrogryposis syndrome) in domestic ruminants, particularly sheep and cattle, and the suspicion exists that most members of the serogroup have the potential for producing this type of disease. *Akabane* has been incriminated in outbreaks of the disease in Japan, Australia and Israel, *Aino* in Japan and Australia, *Tinaroo* in Australia, and *Peaton virus* has been shown to be teratogenic in experimental infections in Australia. The viruses are transmitted by species of *Culicoides* midges which mostly breed in dung, independently of available surface water, but which are favoured by the humid conditions created by heavy rainfall. The natural hosts of the viruses are unknown, but antibodies have been found in wild herbivores. Infection is usually inapparent in domestic ruminants. However, if infection occurs in pregnant animals at critical stages of gestation, there may be embryonal or foetal death, or arrestation of brain development (hydranencephaly), and the consequent lack of trophic effect of nervous stimulation on skeletal muscles of the foetus results in postural defects of the limbs, with joints locked in flexion (arthrogryposis). Once the stage of organogenesis in gesta-

tion is passed, foetuses are less susceptible to the harmful effects of infection (the timing varies with length of gestation in different species).

Shuni virus has been isolated from cattle, sheep, midges and once from the blood of a febrile human in Nigeria, and from cattle and mosquitoes in South Africa. It was also isolated from the brain of a horse with histopathological lesions of meningoencephalitis, which was submitted for laboratory examination for suspected rabies in Zimbabwe (Foggin and Swanepoel, 1977).

GENUS PHLEBOVIRUS

Serogroup Sandfly fever

Sandfly fever Naples, Sandfly fever Sicilian and Toscana viruses

Sandfly fever (also known as phlebotomus fever or pappataci fever from the vector, *Phlebotomus papatasi*) has been known for at least two centuries as a febrile illness encountered by armies invading the Mediterranean basin. It was demonstrated shortly after the turn of the century that the disease was caused by a virus transmitted by sandflies, but it was only during the second world war that it was shown that there are in fact two distinct viruses and that there is no cross-immunity. Between them, the two viruses are known to occur in Morocco, Tunisia, Egypt, Sudan, Somalia, Italy, Greece, Yugoslavia, Turkey, the former USSR, Israel, Saudi Arabia, Iraq, Iran, Pakistan, India and Bangladesh, and are probably present in many intervening countries. Throughout this range *Phlebotomus papatasi* is the vector, and it breeds in moist soil in dark niches such as in rubble, drains, cracks in soil and in animal burrows, equally successfully in large cities as in remote rural locations. The viruses are transmitted transovarially in the vector, which overwinters in the larval stage, and adult flies emerge to assume biting activity in summer. High infection rates have been recorded in newly emerged sandflies and it is not known whether amplification in vertebrates is essential to ensure perpetuation of the viruses, but humans develop sufficiently intense viraemia to serve as source for the infection of the vector. No wild vertebrate hosts of the viruses are known, but antibody has been found in gerbils (whose burrows are utilized by the vector). Sandflies are nocturnal

feeders, but will feed in dark rooms where they rest during daylight hours. Human infection rates recorded in outbreaks range from 3–75%, but the attack rate varies focally and is influenced by background immunity in the human population. Large epidemics have often occurred in association with socioeconomic upheavals, wars or natural disasters such as earthquakes which create ideal breeding conditions for sandflies and/or lead to widespread exposure of susceptible humans to sandflies.

Experimental evidence suggests that most sandfly fever infections are symptomatic. Typically, there is sudden onset of fever of 2–4 days duration, severe headache, sore eyes and photophobia, myalgia, arthralgia, anorexia and malaise. Occasionally there may be sore throat, nausea and vomiting, abdominal pain and diarrhoea, epistaxis and dizziness. Patients may have injected conjunctivae and a flushed appearance, but there is seldom a rash, and meningeal signs are rare. The disease may be milder in children. Treatment is symptomatic. Recovery is complete and no deaths have been recorded. There appears to be lifelong immunity to the homologous virus. The diagnosis can be confirmed by isolation of virus from blood taken in acute illness, or demonstration of IgM antibody activity, or rising antibody titres in convalescence. Prevention of infection includes the use of insect repellants, but the treatment of walls (sandfly resting sites) with residual insecticides is highly effective.

Toscana virus was first isolated in 1971 in Tuscany, Italy, from *Phlebotomus perniciosus*, a sandfly which breeds in forest litter. Antibody was found to be common in the sera of rural and suburban residents of the region, and an association was established between the occurrence of aseptic meningitis and serological evidence of infection with *Toscana virus*. Since then several cases of meningitis due to the infection have been encountered regularly each year in summer months in the endemic region, and these can sometimes be diagnosed by isolation of virus from cerebrospinal fluid in acute illness, but usually by demonstrating IgM antibody activity or rising antibody titres in sera taken during convalescence. The virus is transmitted transovarially in the vector, *P. perniciosus*, and no vertebrate maintenance host has been identified, but antibody has been found in rodent sera, and the virus has been isolated from an insectivorous bat. The vector is widely distributed in Europe and the virus has been isolated from cerebrospinal fluid from a meningitis

Table 18.3 Abridged classification of the genus *Phlebovirus* showing members known to cause infection of humans and domestic animals. Information derived from sources cited in the text

Serogroup ANTIGENIC COMPLEX Virus (Synonym)	Putative vectors	Human infection:			Livestock disease	Distribution
		Natural	Laboratory			
Sandfly fever						
SANDFLY FEVER NAPLES (4) ^a						
<i>Sandfly fever Naples</i>	Phlebotomids	+				Europe, Africa, Asia
<i>Toscana</i>	Phlebotomids	+				Europe
CANDIRU (6)						
<i>Alenquer</i>	Phlebotomids?	+				S. America
<i>Candiru</i>	Phlebotomids?	+				S. America
PUNTA TORO (2)						
<i>Punta Toro</i>	Phlebotomids	+				C. America
RIFT VALLEY FEVER (3)						
<i>Rift Valley fever (Zinga)</i>	Mosquitoes	+	+	+		Africa
Four other complexes (8)						
Unassigned to complex (22)						
<i>Sandfly fever Sicilian</i>	Phlebotomids	+				Europe, Africa, Asia
<i>Chagres</i>	Phlebotomids	+				C. America
Uukuniemi						
UUKUNIEMI (13)						
<i>Uukuniemi</i>	Ixodids	+				Europe
<i>Zaliv Terpinia</i>	Ixodids	+				Asia

^aFigures in parentheses indicate the total numbers of members of the relevant taxon.

patient in Portugal, so the disease may occur more widely than at present recognized.

Alenquer, Candiru, Punta Toro and Chagres viruses

Alenquer and *Candiru* viruses were isolated from the blood of febrile patients in the Amazon region of Brazil, but otherwise little is known of their biology, and it is surmised that they are transmitted by phlebotomid flies. *Punta Toro* and *Chagres* viruses were isolated from febrile patients and from phlebotomids (*Lutzomyia* spp.) in Panama. These two viruses are known to be transmitted transovarially in phlebotomids, and antibodies to them have been found in primates, sloths, porcupines and other rodents. Disease thus far associated with all four viruses fits the description of classical sandfly fever, with the difference that epidemics are unknown and only isolated cases have been seen in persons who entered tropical forests for occupational or recreational purposes.

Rift Valley fever virus

The literature on Rift Valley fever has been reviewed extensively (Henning, 1956; Weiss, 1957; Easterday, 1965; Peters and Meegan, 1981; Shimshony and Barzilai, 1983; Meegan and Bailey, 1989; Swanepoel and Coetzer, 1994). It is an acute disease of domestic ruminants in mainland Africa and Madagascar, caused by a mosquito-borne virus and characterized by necrotic hepatitis and a haemorrhagic state, but infections are frequently inapparent or mild. Large outbreaks of the disease in sheep, cattle and goats are distinguished by heavy mortality among newborn animals and abortion in pregnant animals. Humans become infected from contact with tissues of infected animals or from mosquito bite, and usually develop mild to moderately severe febrile illness, but severe complications occur in a small proportion of patients.

The disease was first recognized in the Rift Valley in Kenya at the turn of the century, but the causative agent was not isolated until 1930. Since then large outbreaks of the disease have been recorded in Kenya, South Africa, Namibia, Mozambique, Zim-

babwe, Zambia, Sudan, Egypt, Mauritania and Senegal, while lesser outbreaks, periodic isolations of virus or serological evidence of infection have been recorded in Angola, Botswana, Burkina Faso, Cameroon, Central African Republic, Chad, Gabon, Guinea, Madagascar, Malawi, Mali, Nigeria, Somalia, Tanzania, Uganda and Zaire. Epidemics may be extremely severe and, for example, it is estimated that 500 000 ewes aborted and a further 100 000 sheep died in the first outbreak of the disease to be recognized in South Africa in 1950–51.

Prior to the 1970s, epidemics were seen only in eastern and southern Africa, where they tend to occur at irregular intervals of 5–15 years or longer when above average rainfall favours the breeding of the mosquito vectors. Meteorological conditions conducive to the occurrence of epidemics usually prevail over large tracts of Africa, so there has been some tendency for outbreaks in adjacent territories such as Zimbabwe and Mozambique, Kenya and Tanzania, or South Africa and Namibia to coincide. The fate of the virus during interepidemic periods was unknown for decades, but on the basis of observations made in Uganda, Kenya and South Africa, it was widely accepted that the virus was endemic in indigenous forests which extend in broken fashion from East Africa to the coastal regions of South Africa. The virus was thought to circulate in *Eretmapodites* spp. mosquitoes and unknown vertebrates in the forests, and to spread in seasons of exceptionally heavy rainfall to livestock-rearing areas where the vectors were believed to be flood-water-breeding aedine mosquitoes of the subgenera *Aedimorphus* and *Neomelaniconion*, which attach their eggs to vegetation at the edge of stagnant surface water. In contrast to other culicine mosquitoes, it is obligatory that the eggs of aedines be subjected to a period of drying as the water recedes before they will hatch on being wetted again when next the area floods. Thus, the aedine mosquitoes overwinter as eggs which can survive for long periods in dried mud, possibly for several seasons if the area remains dry.

On the inland plateau of South Africa, where sheep rearing predominates, surface water gathers after heavy rains in undrained shallow depressions (pans) and farm dams which afford ideal breeding environments for aedines. On the watershed plateau of Zimbabwe, where cattle farming predominates, aedines breed in vleis—low-lying grassy areas

which constitute drainage channels for surrounding high ground, and which are flooded by seepage after heavy rains. Vleis correspond to what are termed dambos in the livestock rearing areas of central and eastern Africa. Sustained monitoring in Zimbabwe revealed that a low level of virus transmission to livestock occurred each year in the same areas where epidemics occurred. The generation of epidemics, therefore, was associated with the simultaneous intensification of virus activity over vast livestock rearing areas where it was already present, rather than lateral spread from cryptic endemic foci. Comparison of the distributions of canopy forests and vleis in Zimbabwe, plotted from satellite images and aerial photographs, with the distribution determined for endemic Rift Valley fever, revealed remarkable overlap between the endemic areas and areas where vleis were common.

A major advance in the understanding of the epidemiology of the disease was made when the virus was isolated from unfed *Aedes mcintoshi* mosquitoes (= *Aedes lineatopennis* sensu lato) hatched in dambos on a ranch in Kenya during interepidemic periods in 1982 and 1984, confirming that the virus is endemic in livestock rearing areas and indicating that it appears to be maintained by transovarial transmission in aedines. The available evidence suggests that in Zimbabwe, as in Kenya, *Aedes mcintoshi* is the most important maintenance vector of the virus while *Aedes dentatus* is probably also a maintenance vector; the same two species and possibly *Aedes unidentatus* and *Aedes juppi* are maintenance vectors on the inland plateau of South Africa. Heavy rainfall and the humid conditions which prevail during epidemics favour the breeding of other biting insects besides aedine mosquitoes. Following extensive flooding of aedine breeding sites, significant numbers of livestock become infected and circulate high levels of virus in their blood during the acute stage of infection. Other culicines and anopheline mosquitoes then become infected and serve as epidemic vectors, particularly *Culex theileri* in southern Africa, and biting flies such as midges, phlebotomids, stomoxids and simuliids serve as mechanical transmitters of infection. Although contagion has been demonstrated on occasion under artificial conditions, non-vectorial transmission is not considered to be important in livestock, as opposed to humans. Epidemics generally become evident in late summer after there has been an initial increase in vector populations and in

circulation of virus, and terminate in late autumn when the onset of cold weather depresses vector activity, or when most animals are immune following natural infection, or after there has been successful intervention with vaccine.

Antibody surveys and laboratory studies have failed to prove that the virus is maintained in transmission cycles in rodents, birds, monkeys, baboons or other wild vertebrates, although it is felt that wild ruminants could play a role similar to their domestic counterparts in areas where they predominate. It is also believed that the possibility of endemicity of the virus in forests cannot be dismissed entirely, and merits further investigation.

It was recognized from the time of the original investigations in Kenya that febrile illness in humans accompanied outbreaks of disease in livestock, and that some patients experienced transient loss of visual acuity, but the occurrence of serious ocular sequelae was first reported in the 1950–1951 epidemic in South Africa. Human deaths following natural infection were first recorded in South Africa during the epidemic of 1974–1976 when seven patients are known to have died of encephalitis and haemorrhagic fever associated with necrotic hepatitis. Subsequently deaths were also observed in Zimbabwe.

Outbreaks of Rift Valley fever were reported in the Sudan in 1973 and 1976. In 1977 and 1978 a major epidemic occurred along the Nile delta and valley in Egypt, causing an unprecedented number of human infections and deaths, as well as numerous deaths and abortions in sheep and cattle and some losses in goats, water buffaloes and camels. Estimates of the number of human cases of disease range from 18 000 to more than 200 000 with at least 598 deaths occurring from encephalitis and/or haemorrhagic fever. A severe epidemic occurred in 1987 in the Senegal river basin of southern Mauritania and northern Senegal. In Mauritania alone an estimated 224 human patients died of the disease, and there was a high rate of abortion in sheep and goats.

The outbreaks of Rift Valley fever which occurred in North and West Africa differed in many respects from the pattern of disease which had hitherto been observed in sub-saharan Africa; in particular they occurred independently of rainfall in arid countries, apparently in association with vectors which breed in large rivers and dams. The presence of the virus in the Sudan and certain west

African countries had long been known from antibody studies, and there had been periodic isolations of the virus in West Africa, where it was sometimes reported as *Zinga virus*, which is now known to be identical to *Rift Valley fever virus*. Various theories were advanced to account for the first known appearance of the virus in Egypt in 1977, including the carriage of infected mosquitoes from the Sudan at high altitude by prevailing winds associated with the inter-tropical convergence zone. The introduction of the virus through the transportation of infected sheep and cattle on the Nile or overland from northern Sudan to markets in southern Egypt was considered to have been the strongest possibility, and the movement of slaughter animals by sea could account for the evidence of infection detected in the northern and eastern coastal areas of Egypt. Although transportation on some routes would take a long time in relation to the course of the infection, *Rift Valley fever virus* has been shown to persist for prolonged periods in various organs of sheep, particularly the spleen, for up to 21 days after infection. The same could be true for goats and cattle, or even the camels brought in by overland caravan routes. It is believed that humans slaughtering or handling the tissues of such animals could have become infected and served as the amplifying hosts for the infection of mosquitoes since the main vector in the Egyptian epidemic, *Culex pipiens*, is known to be peridomestic and anthropophilic. In at least one instance there were indications that human infections centred on a location where introduced camels were slaughtered.

The occurrence of the epidemic in Egypt raised the spectre that Rift Valley fever could be introduced to the mainland of Eurasia, and the possibility was underscored by the fact that the virus is apparently capable of utilizing a wide range of mosquitoes as vectors. Extensive preventive vaccination of livestock was undertaken at the time in the Sinai peninsula and Israel. However, only isolated outbreaks of Rift Valley fever were recorded in Egypt in 1979 and 1980, and thereafter the country remained free of the disease for twelve years until ocular complications of the infection in humans, and abortions in cattle and water buffalo, were noted in the Aswan Governate in May 1993. On this occasion there was not the same tendency for an explosive outbreak of the disease to occur as in 1977–1978, but by October 1993 infections of humans and livestock, including sheep, had been recognized across

the length of the country in Sharqiya, Giza and El Faiyum Governates, and further infections were observed in 1994 (Anonymous, 1993; 1994; Arthur *et al.*, 1993; Botros *et al.*, 1997).

Fears have also been expressed in the past that the virus could be transported to Saudi Arabia with animals exported from Africa for ritual slaughter on the annual Islamic pilgrimage to Mecca. In West Africa, *Rift Valley fever virus* remains active in the vicinity of the Manantali and Diama dams on the Senegal river where the disease occurred in 1987, and with the human and livestock populations being migratory, there is poor herd immunity.

From late October 1997 to February 1998, a large outbreak of Rift Valley fever occurred in northeastern Kenya and adjoining southern Somalia, following the occurrence of heavy rains and extensive flooding in what is essentially an arid area where people had been receiving food relief owing to the extreme drought conditions that had prevailed in the preceding 2 years (Anonymous, 1998). There were heavy losses of livestock and an estimated 500 human deaths, but many of the deaths could have been due to the appearance of malaria in an area not normally affected by this disease. Nevertheless, communications were severely hampered and starving people resorted to the slaughter and consumption of sick animals on a large scale. It was subsequently established that extensive outbreaks of Rift Valley fever had also occurred elsewhere in Kenya and northern Tanzania following heavy rains in the region, and a few human deaths in southern Kenya were also ascribed to the disease.

In contrast to the main vector in the Egyptian epidemic of 1977–1978, the principal mosquito vectors of *Rift Valley fever virus* in sub-Saharan Africa tend to be zoophilic and sylvatic, with the result that humans become infected mainly from contact with animal tissues, although there are instances where no such history can be obtained and it must be assumed that infection has resulted from mosquito bite. Occasional infections diagnosed in tourists from abroad who visited countries in Africa are also thought to have resulted from mosquito bite. Generally, persons who become infected are involved in the livestock industry, such as farmers who assist in dystocia of livestock, farm labourers who salvage carcasses for human consumption, veterinarians and their assistants, and abattoir workers. There are numerous reports of humans

becoming infected while investigating the disease in the field or laboratory, and the first known human fatality was recorded in 1934 in a laboratory worker, but since the infection was complicated by thrombophlebitis and the patient died from pulmonary embolism, the potential lethality of the virus for man was overlooked until fatal infections were recognized during the 1974–1976 epidemic in South Africa. The results of surveys following epidemics in southern Africa indicated that 9–15% of farm residents became infected, with a slight preponderance of adult males, although it appeared that housewives also gained infection from handling fresh meat.

No outbreaks of the disease have been recognized in urban consumer populations and it is surmised that the fall in pH associated with the maturation of meat in abattoirs is deleterious to the virus. Moreover, highest infection rates were found in workers in the by-products sections of abattoirs in Zimbabwe and the implication is that the carcasses of infected animals which reach abattoirs are generally recognized as being diseased and are condemned as unfit for human consumption, and are then sterilized in the process of preparing carcase meal which is used as fertilizer.

Human infection presumably results from contact of virus with abraded skin, wounds or mucous membranes, but aerosol and intranasal infection have been demonstrated experimentally and circumstantial evidence suggests that aerosols have been involved in some human infections in the laboratory, and in the field during the Egyptian epidemic. Many infections in Egypt are thought to have resulted from the slaughter of infected animals outside of abattoirs, and the fact that the mosquito vector was anthropophilic is thought to explain the high incidence of infection which occurred in people of all ages and diverse occupations. Low concentrations of virus have been found in milk and body fluids such as saliva and nasal discharges of sheep and cattle, and it appears that there may have been a connection between human infection and consumption of raw milk in Mauritania. In view of the intense viraemia which occurs in humans and the fact that virus has been isolated from throat washings, it is curious that there are no records of person to person transmission of infection.

Despite the sudden and dramatic change perceived in the nature of the human disease in the mid-1970s, it was deduced from the 598 reported

deaths and 200 000 estimated cases of disease that Rift Valley fever had a case fatality rate of less than 1% in Egypt where a high prevalence of schistosomiasis may have predisposed the population to severe liver disease. The fatality rate may even have been lower in relation to total infections, since an antibody prevalence rate of 30% was detected and the human population estimated at one to three million in the areas affected by the epidemic. On the other hand, remarkably high estimates of 5 and 14% were made for case fatality rates in two separate populations in the 1987 epidemic in Mauritania, on the basis of the proportion of IgM antibody-positive persons who actually reported illness considered to be compatible with Rift Valley fever, but it can be deduced that the fatality rates in terms of total IgM antibody-positive persons are much closer to the corresponding fatality rate in Egypt.

The majority of Rift Valley fever infections in humans are inapparent or associated with moderate to severe, non-fatal, febrile illness. After an incubation period of 2–6 days, the onset of the benign illness is usually very sudden and the disease is characterized by rigor, fever that persists for several days and is often biphasic, headache with retro-orbital pain and photophobia, weakness, and muscle and joint pains. Sometimes there is nausea and vomiting, abdominal pain, vertigo, epistaxis and a petechial rash. Defervescence and symptomatic improvement occur in four to seven days in benign disease and recovery is often complete in two weeks, but in a minority of patients the disease is complicated by the development of ocular lesions at the time of the initial illness or up to four weeks later. Estimates for the incidence of ocular complications range from less than 1% to 20% of human infections, and possibly the differences stem from failure to record mild cases in populations where illiterate persons are less likely to report minor disturbances of vision. The ocular disease usually presents as a loss of acuity of central vision, sometimes with development of scotomas. The essential lesion appears to be focal retinal ischaemia, generally in the macular or paramacular area, associated with thrombotic occlusion of arterioles and capillaries, and is characterized by retinal oedema and loss of transparency caused by dense white exudate and haemorrhages. Sometimes there is severe haemorrhage and detachment of the retina. The lesions and the loss of visual acuity generally resolve over a period of months with variable resid-

ual scarring of the retina, but in instances of severe haemorrhage and detachment of the retina there may be permanent uni- or bilateral blindness.

Probably less than 1% of human patients develop the haemorrhagic and/or encephalitic forms of the disease. Underlying liver disease may predispose to the haemorrhagic form of the illness. The haemorrhagic syndrome starts with sudden onset of febrile illness similar to the benign disease, but within 2–4 days there may be development of a petechial rash, purpura, ecchymoses and extensive subcutaneous haemorrhages, bleeding from needle puncture sites, epistaxis, haematemesis, diarrhoea and melaena, sore and inflamed throat, gingival bleeding, epigastric pain, hepatomegaly or hepatosplenomegaly, tenderness of the right upper quadrant of the abdomen and deep jaundice. This is followed by pneumonitis, anaemia, shock with racing pulse and low blood pressure, hepatorenal failure, coma and cardiorespiratory arrest. Factors contributing to fatal outcome in the hepatic form of the disease include anaemia, shock and hepatorenal failure, with the kidney lesions possibly being as important as shock in producing anuria. A proportion of the less severely affected patients may make a protracted recovery without sequelae.

Encephalitis may occur in combination with the haemorrhagic syndrome. Otherwise, signs of encephalitis in humans may supervene during the acute illness, or up to 4 weeks later and include severe headache, vertigo, confusion, disorientation, amnesia, meningismus, hallucinations, hypersalivation, grinding of teeth, choreiform movements, convulsions, hemiparesis, lethargy, decerebrate posturing, locked-in syndrome, coma and death. A proportion of patients may recover completely, but others may be left with sequelae, such as hemiparesis.

Abortion is the usual, if not invariable, outcome to infection of pregnant ruminants, but an attempt to relate the occurrence of abortion in humans to evidence of Rift Valley fever infection in Egypt produced inconclusive results.

By analogy with the course of events believed to follow natural infection with other arthropod-borne viruses, it can be surmised that the pathogenesis of the disease may involve some replication of virus at the site of inoculation, conveyance of infection by lymphatic drainage to regional lymph nodes where there is further replication with spillover of virus into the circulation to produce primary vir-

aemia, which in turn leads to systemic infection, and that intense viraemia then results from release of virus following replication in major target organs. Wild *Rift Valley fever virus*, which has not been subjected to serial passaging in laboratory host systems, is described as being hepato-, visceros- or pantropic, and immunofluorescence studies in laboratory animals indicate that replication occurs in littoral macrophages of lymph nodes, most areas of the spleen except T-dependent peri-arteriolar sheaths, foci of adrenocortical cells, virtually all cells of the liver, most renal glomeruli and some tubules, lung tissue and scattered small vessel walls, as well as in necrotic foci in the brains of individuals which develop the encephalitic form of the disease. These sites correspond to the lymphoid necrosis in lymph nodes and spleen, hepatic necrosis and adrenal, lung and glomerular lesions seen in humans and livestock, and the brain lesions in humans (encephalitis has not been described in natural disease of ruminants). Titration of infectivity in organ homogenates indicates that the liver and spleen are the major sites of virus replication. Cell damage is ascribed directly to the lytic effects of the virus, but the inflammatory response seen in human brain tissue suggests that there may also be an immunopathological element to the pathogenesis of encephalitis. The same may be true for ocular lesions. Recovery is mediated by non-specific and specific host responses, and the clearance of viraemia correlates with the appearance of neutralizing antibody. No significant antigenic differences have been detected between isolates of the virus, although differences in pathogenicity for laboratory rodents have been demonstrated, and immunity appears to be lifelong.

The haemostatic derangement which occurs in Rift Valley fever has been investigated in detail only in rhesus monkeys, and the mechanisms involved remain speculative. Impairment of coagulation occurs even in benign infection of monkeys, and moderate thrombocytopenia has been observed in benign infection in sheep, but haemostatic derangement is most severe in the fatal hepatic syndrome. It is postulated that the critical lesions are vasculitis and hepatic necrosis. Destruction of the antithrombotic properties of endothelial cells is thought to trigger intravascular coagulation, and the widespread necrosis of hepatocytes and other affected cells to result in the release of procoagulants into the circulation. Severe liver damage presumably

limits or abolishes production of coagulation proteins and reduces clearance of activated coagulation factors, thereby further promoting the occurrence of disseminated intravascular coagulopathy, which in turn augments tissue injury by impairing blood flow. Vasculitis and haemostatic failure result in purpura and widespread haemorrhages.

The scant information available on clinical pathology findings in humans are compatible with observations made in haematological and coagulation studies on monkeys, except that leucocytosis and anaemia may be more marked in severe human disease. In most species there is an initial leucopenia followed by leucocytosis, and the same may be true for humans. Monkeys may have prolonged activated partial thromboplastin times and prothrombin times even in benign infection, and in severe liver disease there may be depletion of coagulation factors II, V, VII, IX, X and XII, thrombocytopenia and platelet dysfunction, increased schistocyte counts and depletion of fibrinogen together with raised fibrin degradation product levels. Raised serum aspartate aminotransferase and alanine aminotransferase levels have been recorded even in benign disease in humans.

Treatment is essentially symptomatic, and supportive therapy in the haemorrhagic disease includes replacement of blood and coagulation factors. Results obtained in animal models suggest that the administration of immune plasma from recovered patients may be beneficial. The antiviral drug ribavirin inhibits virus replication in cell cultures and laboratory animals, and it has been suggested that it could be used even in benign disease in order to obviate the potentially serious complications which may occur in humans.

Specimens to be submitted for laboratory confirmation of the diagnosis include blood from live patients, and tissue samples, particularly liver, but also spleen, kidney, lymph nodes and heart blood of deceased patients. Tissue samples should be submitted in duplicate in a viral transport medium, and in 10% buffered-formalin for histopathological examination.

Viral antigen can frequently be detected rapidly in tissues and/or blood by a variety of immunological methods, including immunodiffusion, complement-fixation, immunofluorescence and enzyme-linked immunoassay. Viraemia lasts for up to a week. The virus is cytopathic and can be isolated readily in almost all cell cultures commonly used in

diagnostic laboratories, and identified rapidly by immunofluorescence. Virus can also be isolated in suckling or weaned mice, or hamsters, inoculated intracerebrally or intraperitoneally, and antigen can be identified in harvested brain or liver by the immunological methods mentioned above. Definitive identification of isolates is achieved by performing neutralization tests with reference antiserum.

Histopathological lesions, particularly those in the liver, are considered to be pathognomonic, and are essentially similar in humans and domestic ruminants. The severity of the lesions varies from primary foci of coagulative necrosis, consisting of clusters of hepatocytes with acidophilic cytoplasm and pyknotic nuclei, multifocally scattered throughout the parenchyma, to massive liver destruction in which the primary foci comprising dense aggregates of cytoplasmic and nuclear debris, some fibrin and a few neutrophils and macrophages, can be discerned against a background of parenchyma reduced by nuclear pyknosis, karyorrhexis and cytolysis to scattered fragments of cytoplasm and chromatin, with only narrow rims of degenerated hepatocytes remaining reasonably intact close to portal triads. Intensely acidophilic cytoplasmic bodies which resemble the Councilman bodies of yellow fever are common, and rod-shaped or oval eosinophilic intranuclear inclusions may be seen in intact nuclei. Icterus may be evident.

Antibody to *Rift Valley fever virus* can be demonstrated in complement-fixation, enzyme-linked immunoassay, indirect immunofluorescence, haemagglutination-inhibition, or neutralization tests. Diagnosis of recent infection is confirmed by demonstrating seroconversion or a fourfold or greater rise in titre of antibody in paired serum samples, or by demonstrating IgM antibody activity in an enzyme-linked immunoassay.

Benign Rift Valley fever in humans must be distinguished from other zoonotic diseases such as brucellosis and Q fever, while the fulminant hepatic disease must be distinguished from the so-called formidable viral haemorrhagic fevers of Africa: Lassa fever, Crimean-Congo haemorrhagic fever, Marburg disease and Ebola fever. The occurrence of HFRS associated with hantavirus infections, is also a theoretical possibility in Africa.

An inactivated and a live attenuated vaccine are available for immunization of livestock, but it is usually difficult to persuade farmers to vaccinate livestock during long interepidemic periods. The

attenuated vaccine confers lifelong immunity in sheep, but is abortigenic and teratogenic in a small proportion of pregnant ewes. The attenuated vaccine is poorly immunogenic in cattle and they are immunized annually with the inactivated vaccine. A formalin-inactivated cell culture vaccine produced in the USA is used on an experimental basis to immunize persons such as laboratory and field workers who are regularly exposed to Rift Valley fever infection.

Serogroup Uukuniemi

Uukuniemi virus

Uukuniemi virus was originally isolated in Finland in 1960 from *Ixodes ricinus* ticks, which parasitize livestock but also bite humans. The virus has subsequently been isolated from ticks, birds and field mice in Finland, Norway, Poland, Lithuania, and the former USSR and Czechoslovakia. Antibody to the virus has been found in human sera in Finland, Hungary and former Czechoslovakia, but no evidence has been presented to indicate that infection is associated with disease. The remaining members of the serogroup have been isolated from ticks associated with passerine or sea birds, and have no known medical or veterinary significance.

GENUS *NAIROVIRUS*

Serogroup Crimean-Congo haemorrhagic fever

Crimean-Congo haemorrhagic fever virus

The literature on CCHF is the subject of several comprehensive reviews (Chumakov, 1974; Hoogstraal, 1979; 1981; Watts *et al.*, 1989). A disease given the name Crimean haemorrhagic fever was first observed on the Crimean peninsula in 1944, and it was demonstrated through the inoculation of human subjects that the disease was caused by a tick-transmitted virus, but the virus itself was only isolated in laboratory hosts, namely mice, in 1967. In 1969, it was shown that the agent of Crimean haemorrhagic fever was identical to a virus named Congo which had been isolated in 1956 from the

Table 18.4 Abridged classification of the genus *Nairovirus* showing members known to cause infection of humans and domestic animals. Information derived from sources cited in the text

Serogroup COMPLEX Virus (Synonym)	Putative vectors	Human infection		Livestock disease	Distribution
		Natural	Laboratory		
Crimean-Congo haemorrhagic fever					
CRIMEAN-CONGO HAEMORRHAGIC FEVER (3) ^a					
<i>Crimean-Congo haemorrhagic fever</i>	Ixodids	+	+		E. Europe, Africa, Asia
Dera Ghazi Khan: one complex (6)					
Hughes: one complex (10)					
Nairobi sheep disease					
NAIROBI SHEEP DISEASE (2)					
<i>Nairobi sheep disease (Ganjam)</i>	Ixodids	+	+	+	Africa, Asia
<i>Dugbe</i>	Ixodids	+	+		Africa
Qalyub: one complex (3)					
Sakhalin: one complex (7)					
Thiafora: one complex (2)					

^aFigures in parentheses indicate the total numbers of members of the relevant taxon.

blood of a febrile child in Stanleyville (now Kisan-gani) in what was then the Belgian Congo (now Zaire), and since that time the two names have been used in combination.

The distribution of CCHF virus extends over eastern Europe, Asia and Africa: the presence of the virus or antibody to it has been demonstrated in the former USSR, Bulgaria, Greece, Turkey, Hungary, Yugoslavia, France, Portugal, Kuwait, Dubai, Sharjah, Iraq, Iran, Afghanistan, Pakistan, India, China, Egypt, Ethiopia, Mauritania, Senegal, Burkina Faso, Benin, Nigeria, Central African Republic, Zaire, Kenya, Uganda, Tanzania, Zimbabwe, Namibia, South Africa and Madagascar. However, the evidence for France and Portugal is based on limited observations and needs to be confirmed.

In many instances virus or antibody was discovered in deliberate surveys, but in some countries of eastern Europe and Asia the presence of CCHF first became evident in nosocomial outbreaks of disease, or in epidemics which arose in circumstances where humans were exposed to ticks and livestock on a large scale, such as in major land reclamation or resettlement schemes in Bulgaria and parts of the former USSR. In recent years the occurrence of the disease has been sporadic in Eurasia, with most cases being recorded in Bulgaria and Yugoslavia. Prior to 1981, a total of 15 cases of the disease had been reported in Africa, eight of them laboratory infections, and only one patient had de-

veloped haemorrhagic manifestations and died. Since then sporadic cases of haemorrhagic disease and deaths have been diagnosed regularly each year in southern Africa, probably as a result of increased awareness among clinicians, and severe disease has also been recorded elsewhere in Africa.

The virus has been isolated from at least 29 species of ticks, but for most species there is no definitive evidence that they are capable of serving as vectors, and in some instances the virus recovered from engorged ticks may merely have been present in the bloodmeal imbibed from a viraemic host. Members of three genera of ixodid ticks, *Hyalomma*, *Dermacentor* and *Rhipicephalus*, have been shown to be capable of transmitting infection transstadially and transovarially, but *Hyalommas* are considered to be the principal vectors, and the known distribution of CCHF virus coincides with the world distribution of members of this genus of ticks. Moreover, the prevalence of antibody to CCHF virus detected in the sera of wild vertebrates in southern Africa was highest in large herbivores known to be the preferred hosts of adult *Hyalomma* ticks, and in small mammals such as hares which are the preferred hosts of immature *Hyalommas*. Mammals of intermediate size, and passerine and water birds, generally lacked evidence of infection, but antibody was found in ostriches which are known to be parasitized by adult *Hyalommas*. Virus or antibody has also been demonstrated elsewhere

in the sera of small mammals of Eurasia and Africa, such as little susliks, hedgehogs, hares and certain myomorph rodents, and in some instances it has been shown that these hosts develop viraemia of sufficient intensity to infect ticks.

High prevalences of antibody occur in domestic ruminants in areas infested by *Hyalomma* and the virus causes inapparent infection or mild fever in cattle, sheep and goats, with viraemia of sufficient intensity to infect ticks. It is doubtful whether trans-ovarial transmission occurs with sufficient frequency in ticks to ensure indefinite perpetuation of the virus in the absence of amplification of infection in vertebrate hosts, and in particular, it is believed that the infection of small vertebrates constitutes an important amplifying mechanism which facilitates transstadial transmission of virus by adult ticks to large vertebrates.

Young ruminants generally acquire natural infection early in life and are viraemic for about a week. Humans become infected when they come into contact with the viraemic blood of young animals in the course of performing procedures such as castrations, vaccinations, inserting ear tags or slaughtering the animals. Animals which are raised under tick-free conditions and moved to infested locations later in life may acquire tick-borne diseases of livestock at the same time that they become infected with CCHF virus, and consequently humans become infected from contact with viraemic blood in the course of treating sick animals or butchering those that die. The available evidence suggests that the infection in humans is acquired through contact of viraemic blood with broken skin, and this accords with the fact that nosocomial infection in medical personnel usually results from accidental pricks with needles contaminated with the blood of patients, or similar mishaps. Common source outbreaks involving more than one case of the disease can occur when several people are exposed to infected tissues. Infection appears to be limited to those who have contact with fresh blood or other tissues, probably because infectivity is destroyed by the fall in pH which occurs in tissues after death, and there has been no indication that CCHF virus constitutes a public health hazard in meat processed and matured according to normal health regulations. Many human infections result directly from tick bite, and it has been observed that people can also become infected from merely squashing ticks between the fingers. Some patients are unable to recall

contact with blood or other tissues of livestock, or having been bitten by ticks, but live in or have visited a rural environment where such exposure to infection is possible. Town dwellers sometimes acquire infection from contact with animal tissues or tick bite while on hunting or hiking trips.

The majority of patients tend to be adult males engaged in the livestock industry, such as farmers, herdsmen, slaughtermen and veterinarians. Seroprevalence studies indicate that infection of humans is uncommon despite the widespread evidence of infection in livestock, and this may be explained by the facts that viraemia in livestock is short-lived, and of low intensity compared to that in other zoonotic diseases such as Rift Valley fever, and that humans are not the preferred hosts of *Hyalomma* ticks. The low prevalences of antibody generally found in populations at risk, and the paucity of evidence of inapparent infection encountered among the cohorts of cases of the disease, suggests that infection is frequently symptomatic.

Incubation periods are generally short, ranging from one to three days (maximum nine) following infection by tick bite, and are usually 5 or 6 days (maximum 13) in persons exposed to infected blood or other tissues of livestock or human patients. Onset of the disease is usually very sudden. Patients develop fever, rigors, chills, severe headache, dizziness, neck pain and stiffness, sore eyes, photophobia, myalgia and malaise, with intense backache or leg pains. Nausea, sore throat and vomiting commonly occur early in the illness and patients may experience non-localized abdominal pain and diarrhoea at this stage. Fever is often intermittent and patients may undergo sharp changes of mood over the next 2 days, with feelings of confusion and aggression. By the second to fourth day of illness patients may exhibit lassitude, depression and somnolence, and have a flushed appearance with injected conjunctivae or chemosis. By this time, tenderness may be localized in the right upper quadrant of the abdomen, and hepatomegaly may be discernible. Tachycardia is common and patients may be slightly hypotensive. There may be lymphadenopathy, and enanthem and petechiae of the throat, tonsils and buccal mucosa.

A petechial rash appears on the trunk and limbs on day 3–6 of illness, and this may be followed rapidly by the appearance of large bruises and ecchymoses, especially in the anticubital fossae, upper arms, axillae and groin. Epistaxis, haematemesis,

haematuria, melaena, gingival bleeding and bleeding from the vagina or other orifices may commence on day 4–5 of illness, or even earlier. Sometimes a haemorrhagic tendency is evident only from the oozing of blood from injection or venepuncture sites. There may be internal bleeding, including retroperitoneal and intracranial haemorrhage. Severely ill patients may enter a state of hepatorenal and pulmonary failure from about day 5 onwards and progressively become drowsy, stuporous and comatose. Jaundice may become apparent during the second week of illness. The mortality rate is approximately 30% and deaths generally occur on day 5–14 of illness. Patients who recover usually begin to improve on day 9 or 10 of illness, but asthenia, conjunctivitis, slight confusion and amnesia may continue for a month or longer.

Changes in clinical pathology values recorded during the first few days of illness include leucocytosis or leucopenia, and elevated aspartate transaminase, alanine transaminase, gamma-glutamyl transferase, lactic dehydrogenase, alkaline phosphatase and creatine kinase levels, while bilirubin, creatinine and urea levels increase and serum protein levels decline during the second week. Thrombocytopenia, elevation of prothrombin ratio, activated partial thromboplastin time, thrombin time and fibrin degradation products, and depression of fibrinogen and haemoglobin values are also evident during the first few days of illness, indicating that the occurrence of disseminated intravascular coagulopathy is probably an early and central event in the pathogenesis of the disease. Changes are more severe in fatal than in non-fatal infections, and the occurrence of certain markedly abnormal clinical pathology values during the first 5 days of illness are predictive of fatal outcome (Swanepoel *et al.*, 1987; 1989).

It is surmised that peripherally introduced CCHF virus undergoes some replication at the site of inoculation, and that haematogenous and lymph-borne spread of infection occurs to organs such as the liver which are major sites of replication. Although it has not been shown conclusively that there is infection of endothelium, capillary fragility is a feature of the disease and there is evidence of formation of circulating immune complexes with complement activation, and this would contribute to damage of the capillary bed and the genesis of renal and pulmonary failure. Endothelial damage would account for the occurrence of a rash and

would contribute to haemostatic failure through stimulating platelet aggregation and degranulation, with consequent activation of the intrinsic coagulation cascade. It is clear from the results of therapeutic administration of platelets to patients that they are consumed, and evidence of depression of thrombopoiesis in bone marrow has been reported. Widespread tissue damage in organs such as the liver would result in further release of procoagulants such as tumour necrosis factor into the bloodstream, and impairment of the circulation through the occurrence of a disseminated intravascular coagulopathy would contribute to further tissue damage. Damage to the liver would also impair synthesis of coagulation factors to replace those which are consumed.

Lesions in the liver vary from disseminated foci of coagulative necrosis, mainly mid-zonal in distribution, to massive necrosis involving over 75% of hepatocytes, and a variable degree of haemorrhage, with little or no inflammatory cell response. Lesions in other organs include congestion, haemorrhage and focal necrosis in the central nervous system, kidneys and adrenals, and general depletion of lymphoid tissues. Fibrin deposits may be seen in small blood vessels in parenchymatous organs including the liver, and thrombus formation and infarction may contribute to the pathogenesis of the necrotic lesions in these organs.

Where possible, patients are treated by specially trained staff in institutions equipped for handling formidable viral haemorrhagic fevers, and barrier-nursing techniques are used for the protection of medical personnel. Therapy appropriate for disseminated intravascular coagulopathy, such as the use of heparin, may be contemplated early in the course of the disease by clinicians well versed in the treatment of haemostatic failure, but the procedure is considered to be risky, and generally only patients who acquire nosocomial infection come to medical attention at a sufficiently early stage. Standard treatment consists of replacement of red blood cells, platelets, other coagulation factors, protein (albumin) and intravenous feeding as indicated by clinical pathology findings. Immune plasma from recovered patients has been used in therapy, but there is no firm evidence from controlled trials of the value of the treatment, and there has been a lack of a uniform product with proven virus-neutralizing activity. Ribavirin has been found to inhibit virus replication in cell cultures, and in suckling mice,

and preliminary results of a trial in human patients are promising.

On account of the propensity of the virus to cause laboratory infections, and the severity of the human disease, investigation of CCHF is generally undertaken in maximum security laboratories in countries which have biosafety regulations. Specimens to be submitted for laboratory confirmation of the diagnosis include blood from live patients and, in order to avoid performing full autopsies, heart blood and liver samples taken with a biopsy needle from deceased patients. Virus can be isolated from blood and organ suspensions in a wide variety of primary and line cell cultures, including Vero, CER and BHK-21 cells, and identified by immunofluorescence. Isolation and identification can be achieved in 1–5 days, but cell cultures lack sensitivity and usually only detect high concentrations of virus present in the blood of severely ill patients during the first 5 days or so of illness. Intracerebral inoculation of suckling mice is more sensitive and can be used to demonstrate low concentrations of virus present in blood up to 13 days after the onset of illness. Virus antigen can sometimes be demonstrated in the blood of severely ill patients with intense viraemia, or in liver suspensions, by enzyme-linked immunoassay.

Antibodies, both IgG and IgM, become demonstrable by indirect immunofluorescence from about day 7 of illness (slightly earlier by enzyme-linked immunoassay), and are present in the sera of all survivors of the disease by day nine at the latest. The IgM antibody activity declines to undetectable levels by the fourth month after infection, and IgG titres may begin to decline gradually at this stage, but remain demonstrable for at least 5 years. Recent or current infection is confirmed by demonstrating seroconversion, or a fourfold or greater increase in antibody titre in paired serum samples, or IgM antibody activity in a single sample. Patients who succumb rarely develop a demonstrable antibody response and the diagnosis is confirmed by isolation of virus from serum, or from liver specimens. Observation of necrotic lesions compatible with CCHF infection in sections of liver, provides presumptive evidence in support of the diagnosis.

The disease must be distinguished from the other so-called formidable viral haemorrhagic fevers: Lassa fever, Marburg disease, Ebola fever and HFRS (hantavirus infections), other febrile illnesses such as Rift Valley fever, Q fever and brucellosis

which can be acquired from contact with animal tissues, as well as tick-borne typhus (*Rickettsia conorii* infection commonly known as tickbite fever), but many other conditions including bacterial septicaemias may resemble CCHF.

The control of CCHF through the application of acaricides to livestock is impractical, particularly under the extensive farming conditions which prevail in the arid areas where *Hyalomma* ticks are most prevalent. Pyrethroid preparations are available which can be used to kill ticks which come into contact with human clothing. Veterinarians, slaughtermen and others involved with livestock should be aware of the disease and take practical steps, such as the wearing of gloves, to limit or avoid exposure of naked skin to fresh blood and other tissues of animals. Inactivated mouse brain vaccine for the prevention of human infection has been used on a limited scale in eastern Europe and the former USSR. Development of a safe and effective modern vaccine is inhibited by the limited potential demand for such a vaccine.

Serogroup Nairobi sheep disease

Nairobi sheep disease virus

Nairobi sheep disease virus was first isolated from sheep blood in Kenya in 1910 and is known to be associated with disease of small ruminants, specifically sheep and goats, in a narrow band straddling the equator from Kenya in the east to Congo in the west. Antibody, but not disease, has also been found to the north of Kenya in Ethiopia and Somalia, and southwards along the east of the continent to Mozambique and Botswana. The virus can be transmitted transstadially by a range of ixodid ticks, including *Amblyomma variegatum*, but the endemic vector appears to be *Rhipicephalus appendiculatus*, in which transovarial transmission occurs. The disease in sheep and goats is characterized by fever, haemorrhagic gastroenteritis, and abortion in pregnant animals. High mortality occurs when susceptible sheep or goats are introduced into an endemic area, but within such areas young animals appear to undergo benign infection as maternal immunity wanes, and there is a high prevalence of immunity in adult animals. Attenuated live and killed vaccines for sheep and goats are available in East Africa. Small antelope are susceptible to the

disease, and rodents develop viraemic infection, but seroprevalence studies have failed to identify wild maintenance hosts of the virus. Larger ruminants such as cattle and buffalo, are not susceptible to the disease. The virus has been isolated from human blood in association with febrile illness with arthralgia and malaise in Uganda, and laboratory infection has been recorded. Antibody prevalence rates of up to 20% have been found in humans in endemic areas.

Ganjam virus, first isolated from ixodid ticks in India in 1954, is considered to be either closely related or identical to *Nairobi sheep disease virus*. It has been isolated from the blood of sheep and humans with febrile illness in India, where it is associated with ticks of the genus *Haemaphysalis*. There is speculation that the virus may have been translocated from India to Africa with ectoparasites on sheep and goats, which have been traded along sea routes for centuries.

Dugbe virus

There have been approximately 600 isolations of *Dugbe virus* from ixodid ticks, mainly *Amblyomma variegatum*, in Nigeria, Central African Republic and Ethiopia. The virus has also been isolated frequently from cattle blood in surveys, and from a giant rat (*Cricetomys gambianus*), aedine mosquitoes and *Culicoides* midges in Nigeria, and there is serological evidence of the occurrence of the virus in Senegal and Uganda. There have been seven isolations of the virus from the blood of persons with benign febrile illness in Nigeria and Central African Republic (including a laboratory infection). One patient had mild meningitis and virus was isolated from cerebrospinal fluid. Surprisingly, serosurveys have not revealed widespread human infection.

GENUS HANTAVIRUS

Hantaan, Dobrava, Seoul, Puumala, Sin Nombre and related viruses

Hantaviruses are associated with a range of nephrotic diseases in Asia and Europe known variously as haemorrhagic nephrosonephritis, Korean haemorrhagic fever, Songo fever, epidemic haemorrhagic fever and nephropathia epidemica, but use of the

generic term haemorrhagic fever with renal syndrome (HFRS) is advocated, while the term hantavirus pulmonary syndrome (HPS) is preferred for respiratory disease associated with hantaviruses in the Americas.

The existence of a febrile disease with haemorrhagic and renal manifestations has been recognized in Eurasia at least since the early years of the twentieth century and, in fact, descriptions of similar disease can be traced back to antiquity. A disease known by various names, including haemorrhagic nephrosonephritis, and which caused outbreaks among civilians and soldiers, was investigated independently in the far eastern region of the former USSR and in Manchuria prior to the second world war, and by the early 1940s it was established that the condition could be transmitted to human volunteers by inoculation of filtrates of patients' blood or urine, or tissue extracts from *Apodemus* field mice (it had been observed that the incidence of disease was greatest at the end of summer when the mice were most numerous). At the same time a febrile syndrome with abdominal pain, backache and renal manifestations was recognized in Scandinavia and numerous cases of this disease, later named nephropathia epidemica (NE), were observed in soldiers during the second world war.

Thousands of cases of a disease named Korean haemorrhagic fever were observed in soldiers and civilians during the Korean war of the early 1950s, and the disease continued to be seen after the war. In 1976 it was found that convalescent sera from patients in Korea could be used to demonstrate the presence of an antigen by immunofluorescence in the tissues of *Apodemus agrarius* field-mice caught near the Hantaan river. The antigen was shown to be associated with a virus which could be subcultured in field mice. The virus, named *Hantaan*, was successfully grown in cell cultures in 1981, and shortly thereafter characterized as a member of the family *Bunyaviridae* and placed in a new genus *Hantavirus*. The virus is widely distributed as the causative agent of HFRS in Asia, particularly in the eastern portion of the former USSR, China and Korea. Virus associated with a severe form of HFRS in the Balkans (Albania, Greece, former Yugoslavia and Bulgaria) has been found to be distinct from *Hantaan*, and has recently been designated as *Dobrava virus*. It is associated with the yellow-necked field mouse, *Apodemus flavicollis*, as well as with *Apodemus agrarius*, and evidence is

emerging to suggest that it may be more widely distributed in Europe than previously realized.

In 1980 the presence of the causative agent of nephropathia epidemica was demonstrated by immunofluorescence in the tissues of *Clethrionomys glareolus* voles in Finland, and subsequently the agent, named *Puumala virus*, was grown in cell cultures and shown to be related to *Hantaan virus*. Although evidence obtained in former Yugoslavia, Germany, Belgium, France and Britain suggests that *Puumala virus* occurs widely in Europe, it is most prevalent at northerly latitudes, extending into the Arctic circle in Scandinavia and the adjoining western portion of the former USSR, where highest concentrations of the bank vole occur.

Seoul virus was isolated in 1980 in Korea from the tissues of peridomestic rats, *Rattus norvegicus* and *Rattus rattus*, in association with human disease which occurred in urban as opposed to rural environments. It has been incriminated as the cause of human disease in Japan, China and Korea, but has been isolated from rats in Egypt, the USA and elsewhere, and probably has a worldwide distribution. Isolation of the virus from rats led to speculation that hantaviruses in general may have been disseminated worldwide with ship-borne rodents. However, the distribution patterns of most hantaviruses within the interiors of continents, and the evolution of particular host relationships, constitute evidence against recent spread of the viruses.

The findings in Asia and Europe prompted interest elsewhere, and as a result *Prospect Hill virus* was isolated from *Microtus pennsylvanicus* voles in the USA, but no disease associations have been described for this virus.

In May 1993, an outbreak of an acute respiratory disease in adults, with a high fatality rate, was recognized in the Four Corners region of southwestern USA, where the borders of the states of Utah, Colorado, Arizona and New Mexico meet, but the initial occurrence of cases could be traced back to late 1992. Antibody cross-reactive with the antigens of known hantaviruses was found in the sera of patients, and by means of reverse transcription and the polymerase chain reaction with consensus sequence hantavirus primers, it was possible to demonstrate the presence of nucleic acid of a novel hantavirus in the tissues of patients. The nucleotide sequence of the entire genome of the virus was determined even before it could be isolated and grown in cell cultures. The outbreak was apparently

associated with a population explosion of the deer mouse, *Peromyscus maniculatus*, incriminated as the natural host of the virus. Sporadic cases of similar disease were recognized elsewhere in the USA, some retrospectively, and by the end of 1993 a total of 53 cases had been confirmed (Nichol *et al.*, 1993; Bremer, 1994; Duchin *et al.*, 1994). After objections were raised to various names proposed for the new virus, *Sin Nombre* (Spanish for 'without name') was adopted, and the disease was referred to as HPS.

Isolated cases and outbreaks of HPS were subsequently recognized beyond the distribution range of *Peromyscus maniculatus* in the USA, in Canada, and in several countries of South America. A succession of new hantaviruses was discovered in association with HPS, or in rodents tested speculatively in surveys. Several new viruses were also discovered in rodents in Europe and Asia, and unidentified viruses which had previously been isolated from bandicoots in Thailand and from suncid shrews in India were found to be hantaviruses. In general, the new viruses were discovered through the detection of cross-reactive antibody activity to hantavirus antigens, followed by the application of the polymerase chain reaction to detect viral nucleic acid, and genetic characterization. Adaptation to cell cultures followed the initial identification of the viruses, but *in vitro* culture has not yet been achieved in all instances. It is suspected that in addition to the hantaviruses currently known to be human pathogens, some of the remaining viruses may also prove to be associated with disease (Table 17.5) (Schmaljohn and Hjelle, 1997; Kanerva *et al.*, 1998; Monroe *et al.*, 1999).

Serological classification of hantaviruses has lagged behind genetic characterization, primarily because the lack of *in vitro* culture systems for some of the viruses has prevented the performance of definitive cross-neutralization tests, but the extant information on antigenic affinities is in agreement with the genetic clustering of the viruses, which in itself conforms with the phylogeny of the rodent hosts (Table 18.5) (Arthur *et al.*, 1992; Puthathana *et al.*, 1992; Chu *et al.*, 1994; 1995; Schmaljohn and Hjelle, 1997; Kanerva *et al.*, 1998; Monroe *et al.*, 1999). In brief, all hantaviruses are antigenically related, with greatest affinities existing within clusters designated Hantaan-like, Puumala-Prospect Hill-like, and Sin Nombre-like, while *Thottapalayam virus* from shrews in India is more distantly related to the others. Viruses of the Hantaan-

Table 18.5 Classification of members of the genus *Hantavirus*. Information derived from sources cited in the text

Vertebrate host: Order: Subfamily				
Virus genotype	Known/suspected host	Disease	Distribution	
Subtype/variety				
Rodentia: Murinae				
(Hantaan-like viruses)				
<i>Hantaan</i>	<i>Apodemus agrarius</i>	HFRS	Asia	
<i>Dobrava</i>	<i>Apodemus flavicollis</i>	HFRS	Europe	
	<i>Apodemus agrarius</i>			
<i>Seoul</i>	<i>Rattus norvegicus</i>	HFRS	Worldwide	
	<i>Rattus rattus</i>			
<i>Thailand</i>	<i>Bandicota indica</i>		Asia	
Rodentia: Arvicolinae				
(Puumala–Prospect Hill-like viruses)				
<i>Puumala</i>	<i>Clethrionomys glareolus</i>	HFRS (NE)	Europe	
<i>Tobetsu</i>	<i>Clethrionomys rufocanus</i>		Japan	
<i>Topografov</i>	<i>Lemmus sibiricus</i>		Siberia	
<i>Khabarovsk</i>	<i>Microtus fortis</i>		Siberia	
<i>Tula</i>	<i>Microtus arvalis</i>		Europe	
<i>Prospect Hill</i>	<i>Microtus pennsylvanicus</i>		N. America	
<i>Bloodland Lake</i>	<i>Microtus ochrogaster</i>		N. America	
<i>Prospect Hill-like</i>	<i>Microtus pennsylvanicus</i>		N. America	
	<i>Microtus montanus</i>			
	<i>Microtus ochrogaster</i>			
<i>Isla Vista</i>	<i>Microtus californicus</i>		W. USA, Mexico	
Rodentia: Sigmodontinae				
(Sin Nombre-like viruses)				
<i>Sin Nombre</i>	<i>Peromyscus maniculatus</i> (Grassland form)	HPS	W. and C. USA, Canada	
<i>Monongahela</i>	<i>Peromyscus maniculatus</i> (forest form)	HPS	E. USA, Canada	
<i>New York</i>	<i>Peromyscus leucopus</i> (eastern haplotype)	HPS	E. USA	
<i>Blue River</i>	<i>Peromyscus leucopus</i> (S.W./N.W. haplotypes)		C. USA	
<i>Bayou</i>	<i>Oryzomys palustris</i>	HPS	S.W. USA	
<i>Black Creek Canal</i>	<i>Sigmodon hispidus</i> (Eastern form)	HPS	S.E. USA	
<i>Muleshoe</i>	<i>Sigmodon hispidus</i> (Western form)		S. USA	
<i>Caño Delgadito</i>	<i>Sigmodon alstoni</i>		Venezuela	
<i>Andes</i>	<i>Oligoryzomys longicaudatus</i>	HPS	Argentina, Chile	
<i>Oran</i>	<i>Oligoryzomys longicaudatus</i>	HPS	N.W. Argentina	
<i>Lechiguanas</i>	<i>Oligoryzomys flavescens</i>	HPS	C. Argentina	
<i>Bermejo</i>	<i>Oligoryzomys chacoensis</i>		N.W. Argentina	
<i>Hu 39694^a</i>	Unknown	HPS	C. Argentina	
<i>Pergamino</i>	<i>Akadon azarae</i>		C. Argentina	
<i>Maciel</i>	<i>Bolomys obscurus</i>		C. Argentina	
<i>Laguna Negra</i>	<i>Calomys laucha</i>	HPS	Paraguay, Bolivia	
<i>Juquitiba</i>	Unknown	HPS	Brazil	
<i>Rio Mamore</i>	<i>Oligoryzomys microtis</i>		Bolivia, Peru	
<i>El Moro Canyon</i>	<i>Reithrodontomys megalotis</i>		W. USA, Mexico	
<i>Rio Segundo</i>	<i>Reithrodontomys mexicanus</i>		Costa Rica	
Insectivora: Crocidurinae				
<i>Thottapalayam</i>	<i>Suncus murinus</i>		India	

^aLocation where infection occurred is uncertain; virus will be named when the distribution and/or rodent is host known; HFRS = haemorrhagic fever with renal syndrome; HPS = hantavirus pulmonary syndrome.

like group are associated with rodent hosts of the subfamily *Murinae* and with HFRS; Puumala-Prospect Hill-like viruses are associated with the subfamily *Arvicolinae* (voles and lemmings) and with NE, and Sin Nombre-like viruses with the subfamily *Sigmodontinae* and with HPS (Table 18.5). Despite the fact that *Seoul virus* appears to be very widely distributed, incontrovertible evidence of disease associated with hantaviruses (detection of virus) has been obtained only for Asia, Europe and the Americas, while elsewhere there has only been inconclusive serological evidence of infection. However, *Seoul*, *Hantaan* and *Puumala* viruses have been encountered as contaminants of laboratory rodent colonies and are known to have caused infections in laboratory workers in the former USSR, Korea, Japan, Belgium, France and England. In one instance virus was inadvertently preserved for years in rat tissues kept in frozen storage. Hence, the potential exists for inadvertent dissemination of the viruses.

The distributions of the hantaviruses, insofar as they are known, tend to overlap, but conform to the distributions of the rodent hosts. Individual viruses have been isolated from more than one type of rodent, but each tends to have a particular association with a single species of rodent. The viruses appear to be apathogenic for their reservoir hosts. After the rodents become infected there is an initial viraemia followed by the persistence of infection, probably for life, in lungs, kidneys and possibly other organs, with chronic excretion of virus in urine, faeces and saliva, despite the occurrence of a demonstrable immune response. There does not appear to be intrauterine transfer of infection, and transmission between rodents is thought to occur by bite, aerosol or contamination of dust, food and other fomites with excreted virus. Gamasid mite parasites of rodents are suspected to be capable of transmitting infection, but transmission occurs in the laboratory in the absence of mites. Foci with very high infection rates are observed among rodents in nature.

Humans become infected by the same means as rodents, but airborne infection from dust contaminated with rodent urine and faeces appears to be the principal mechanism, and has been observed to occur even in persons who briefly visited infected colonies of laboratory rodents. Infection occurs in three main situations: rural or sylvatic infection with Hantaan-like, Puumala-like or Sin Nombre-

like viruses occurs in persons who have occupational, residential or recreational exposure to rodent-infested buildings or to the outdoors, urban infection with *Seoul virus* occurs indoors in association with rat infestations, while all of the viruses may cause infections associated with laboratory rodents. Rodents are subject to periodic population explosions and crashes, and the incidence of human infection with Hantaan-like, Puumala-like and Sin Nombre-like viruses increases in years when the rodents are most numerous. Person-to-person spread of hantavirus infection has been observed only in an outbreak of 20 cases of HPS caused by *Andes virus* in southern Argentina, but it could not be established whether transmission was associated with direct contact, droplets, aerosols or contaminated fomites (Wells *et al.*, 1997). In excess of 250 cases of HPS have been reported in the Americas, and up to 200 000 hospitalized cases of HFRS are recorded each year, with more than half occurring in China (Schmaljohn and Hjelle, 1997; Monroe *et al.*, 1999).

Four clinical forms of HFRS are recognized and these vary in order of increasing severity from nephropathia epidemica associated with Puumala virus infection, through mild or rat-borne HFRS associated with Seoul virus infection, to far eastern HFRS associated with Hantaan virus strains carried by *Apodemus agrarius* field mice, and so-called Balkan HFRS associated with Dobrava virus strains carried by *Apodemus flavicollis* and *Apodemus agrarius* mice.

Far eastern HFRS occurs in China, the eastern part of the former USSR and Korea, mainly in adult males with occupational exposure to the outdoors, such as farmers, forest workers and soldiers stationed in the field, and seldom occurs in persons under 10 years of age. Most cases are seen in autumn and early winter when crops are harvested and the rodents are most numerous, and subsequently when the agricultural products are stored in proximity to homesteads. The incidence of asymptomatic infection is unknown, but it was noted that American soldiers participating in an exercise in Korea who seroconverted, had all been ill, while in parts of Korea high antibody prevalence rates without corresponding levels of disease have been observed.

The classical form of far eastern HFRS described in Korea has well-marked phases, but these may overlap and be obscured in mild cases (Lee, 1982).

An incubation period of 2–3 weeks is followed by the abrupt onset of a febrile phase which lasts 3–7 days and is marked by high fever, chills, malaise, myalgia, anorexia, headache, dizziness, ocular pain, and abdominal and back pain, which is felt particularly in the renal area as a result of peritoneal and retroperitoneal oedema. Proteinuria is marked during this phase. Towards the end of the phase there is characteristic flushing of the face, neck and anterior chest, with the conjunctivae, palate and pharynx assuming an injected appearance, followed by the emergence of fine petechiae on the face, neck, soft palate and chest, together with conjunctival haemorrhages. Patients next enter a hypotensive phase which lasts hours to 2 days, and is marked by classical shock: tachycardia, narrowed blood pressure, cold and clammy skin, dulled senses and confusion. One-third of fatal cases enter irreversible shock at this stage. There is marked proteinuria, microscopic haematuria, raised haematocrit levels (haemoconcentration), leukaemoid reaction and thrombocytopenia. Capillary haemorrhages are prominent. The patients then enter an oliguric phase which lasts 3–7 days. Blood urea and creatinine levels increase, blood pressure begins to normalize, but hypertension may result from a hypervolaemic state. Bleeding tendencies increase markedly, and there may be epistaxis, conjunctival, cerebral and gastrointestinal haemorrhages and extensive purpura. There may be severe nausea and vomiting, lung oedema and symptoms referable to the central nervous system. Most deaths occur at this stage. A diuretic phase which follows may last days or weeks, and marks the start of clinical recovery. Diuresis of 3–6 litres per day is common, but is influenced by dehydration, electrolyte imbalance or secondary infections. Severely ill patients are at risk in this phase and may lapse into shock. A convalescent phase with progressive recovery of glomerular filtration rate, renal blood flow and urine-concentrating ability, may last 2–3 months. Mortality has been reduced from the 10–15% observed during the Korean war to 5%, with intensive supportive therapy and renal dialysis.

Balkan HFRS, associated with *Dobrava virus*, is also seen mainly in adult males, including woodcutters, shepherds and military personnel, but cases generally occur in spring and summer, possibly because there is not the same type of cereal crop farming as in the Far East, and the reservoir host is encountered in outdoor activities and at campsites

during the warmer months of the year. The disease is essentially similar to far eastern HFRS, but is more severe, with a higher proportion of patients requiring renal dialysis, and with a greater tendency for the development of disseminated intravascular coagulopathy and haemorrhages. Reported death rates range from 5 to 35%.

Natural outbreaks of mild or rat-borne HFRS, as opposed to outbreaks associated with laboratory rodent colonies, have been recorded in cities in Japan, China and Korea. The disease occurs in urban residents who have no contact with field rodents, and most cases are seen in spring and early summer. The disease is less severe and runs a shorter course than disease associated with Hantaan virus infections, and has less distinct clinical phases. There is also less tendency for haemorrhages and renal failure to occur, and frequently signs of liver involvement are dominant: abdominal pain, hepatomegaly and hepatic dysfunction. There are few deaths and mortality has been estimated at 1% or less.

Infection with Puumala-type virus occurs widely in Europe, but the disease, nephropathia epidemica, is recognized most frequently in Scandinavia and the neighbouring western region of the former USSR. The disease affects mainly adult males and infection appears to be associated principally with outdoor activities. Disease is seen most commonly in late autumn and early winter, but many cases occur in late summer following the traditional vacation season. Cases seen during the colder months are ascribed to the invasion of homes and barns by voles at the onset of winter. The incubation period is thought to be about 1 month, but a range of 3 days to 6 weeks has been reported. There is abrupt onset of fever, headache and malaise. By the third or fourth day of illness there is nausea, vomiting and abdominal and lumbar pain. At this stage there may be azotemia, oliguria and proteinuria, which peaks 1 week after the onset of illness and declines over the next 3–6 days. Patients are extremely ill during the oliguric phase, and may manifest somnolence, restlessness, confusion and meningismus. Transient myopia or blurred vision is regarded as pathognomonic. Facial flushing and maculopapular rash of the neck and trunk are seen occasionally, as are hepatomegaly, cervical lymphadenopathy, and haemorrhages such as epistaxis and gastrointestinal bleeding. Patients seldom require renal dialysis. The oliguria is followed by polyuria of 3–4 litres daily

for 7–10 days. At one stage it was thought that HFRS/NE and HPS were entirely distinct syndromes, but it is now recognized that there is some overlap, and in particular a proportion of NE patients may develop pulmonary infiltration similar to HPS, and some may even exhibit respiratory distress. Clinical improvement begins with the onset of polyuria, and 2 weeks after the onset of fever patients are subjectively well, but backache and lassitude may recur over weeks, and hyposthenuria may persist for months. Recovery is usually complete, and mortality is consistently less than 1%. The relatively high prevalence of antibody found in surveys suggests that inapparent infections may outnumber cases of overt disease by up to 20-fold.

It should be stressed that the hantaviruses overlap in distribution and in the severity of HFRS which they induce, and for instance, neither rural or urban domicile of patients, nor season of occurrence of disease, allow Hantaan and Seoul virus infections to be distinguished with certainty in Asia. Infections with Dobrava and Puumala type viruses in the Balkans may be equally difficult to distinguish.

Persons who develop HPS are often healthy young adults, but may be of any age and either sex, although the disease occurs infrequently in children. Infection is acquired in similar manner to HFRS from occupational, residential or recreational exposure to the outdoors or rodent infested buildings, and in many instances infected rodents have been found in the homes of victims. Incubation periods are similar to HFRS, generally falling into the range 2–3 weeks, but the disease is characterized by severe cardiopulmonary dysfunction rather than renal failure and haemorrhage, despite the facts that there is similar underlying capillary permeability and marked thrombocytopenia. Onset of the prodromal phase of the disease is marked by sudden development of fever, headache, severe myalgia and a cough which may be productive in some instances. Gastrointestinal manifestations in some patients include abdominal pain, nausea, vomiting and diarrhoea. After 3–6 days of illness there is progressive tachypnoea, tachycardia and hypotension, preceding the onset of acute respiratory distress with pulmonary oedema. Patients are generally hospitalized at this stage, but some may die before they can be admitted. In addition to tachypnoea, tachycardia and hypotension, on admission patients may be found to have proteinuria, leucocytosis with neu-

trophilia, plus increased myeloid precursors and atypical lymphocytes, haemoconcentration and thrombocytopenia, plus increased prothrombin and partial thromboplastin times, although there is no rash and seldom a tendency towards overt or internal bleeding. Within 2 days of being admitted to hospital most patients develop diffuse bilateral interstitial and alveolar pulmonary infiltration and pleural effusions demonstrable on radiographs, with hypoxaemia which has necessitated intubation, mechanical ventilation and oxygen supplementation in up to 88% of patients in some outbreaks. Renal insufficiency can occasionally follow prolonged hypoperfusion, but early renal insufficiency and increased serum creatine kinase levels (evidence of skeletal muscle inflammation) are not uncommon in infection with *Andes*, *Bayou* and *Black Creek Canal* viruses. Death generally occurs 6–8 days after the onset of illness, often within 48 hours of admission to hospital, but can range from 2 days after the observed onset of illness to more than 2 weeks. Fatality rates often exceed 40%, and incurable shock and myocardial dysfunction may contribute to the high mortality. Autopsies reveal non-cardiogenic pulmonary oedema and serous pleural effusions, with scant lymphoid infiltration of the lung tissue. Some survivors manifested transient diuresis, but otherwise they make an uneventful recovery without sequelae (Nichol *et al.*, 1993; Bremner, 1994; Duchin *et al.*, 1994; Schmaljohn and Hjelle, 1997; Kanerva *et al.*, 1998).

The underlying lesion in the pathogenesis of hantavirus syndromes appears to be vascular damage, and this is thought to be mediated by both viral invasion of endothelial cells, and immunopathological mechanisms. Capillaries and small blood vessels dilate and there is extravasation of plasma and cellular elements into tissues, and the pathological changes observed in multiple systems all appear to be referable to the vascular damage (Kanerva *et al.*, 1998).

Treatment of HFRS involves complex, phase-specific monitoring and support of homeostasis, including fluid and electrolyte balances. Trials of ribavirin for the treatment of the disease in China have been complicated by difficulties such as lack of uniformity of clinical status of patients at the time of protocol entry, but there are indications that use of the drug reduces mortality and leads to improvement of objective markers of patient well-being, and clinical pathology values. Epidemiological evidence

suggests that there is lifelong immunity to hantaviruses, at least to the homologous serotype. There has been research on recombinant vaccines, but these are likely to find application only in Asia where suitable populations at risk can be identified.

Investigation of hantavirus infections is usually undertaken in high security laboratories to minimize the exposure of staff to infection. Isolation and identification of hantaviruses is a notoriously difficult and time-consuming procedure, and is rarely successful on serum and urine specimens from patients. Demonstration of viral antigens in sera and urine is equally unsuccessful. Viral nucleic acids of hantaviruses can be detected in the tissues of human patients and experimentally and naturally infected rodents by means of reverse transcription and the polymerase chain reaction with appropriate primers (Arthur *et al.*, 1992; Grankvist *et al.*, 1992; Xiao *et al.*, 1992; Nichol *et al.*, 1993; Monroe *et al.*, 1999). Detection of IgM antibody by enzyme-linked immunoassay holds greatest promise as a rapid diagnostic technique. Antibody activity appears to be present in the sera of HFRS patients from the time of hospitalization, and titres increase rapidly over the next 2 weeks. Owing to the antigenic cross-reactivity between hantaviruses, it may be difficult to determine the serotype of the virus responsible for the infection from antibody tests, but this can sometimes be inferred by using a range of antigens in enzyme-linked immunoassays (Feldmann *et al.*, 1993), or by performing neutralization tests with the full range of serotypes: antibody titres tend to be highest against the homologous infecting serotype. In attempts to diagnose infection by an unknown hantavirus, particularly in locations where local viruses are unknown, it is advisable that antigens representative of all four antigenic types be included in the tests: Hantaan-like, Puumala-Prospect Hill-like and Sin Nombre-like viruses and *Thottapalyam virus*.

POSSIBLE MEMBERS OF THE FAMILY BUNYAVIRIDAE

Bhanja, *Kasokero*, *Bangui*, *Issyk-Kul*, *Tataguine* and *Wanowrie* viruses

Bhanja virus has been isolated from ixodid ticks of five genera—*Haemaphysalis*, *Amblyomma*, *Dermacentor*, *Boophilus* and *Hyalomma*—variously in In-

dia, the former USSR, Yugoslavia, Bulgaria, Slovakia, Somalia, Central African Republic, Nigeria and Senegal. It has been suggested that the wide distribution of the virus could have resulted from the carriage of immature ticks on migrating birds, although birds do not themselves appear to be susceptible to the virus. Isolations of the virus have also been made from a hedgehog, ground squirrel and blood samples from cattle and sheep in Nigeria. Antibody has been found in cattle, sheep and goats parasitized by the ticks, and in human sera in Slovakia, Yugoslavia, Italy and the Central African Republic. Mild febrile illness was observed in two human patients who acquired laboratory infection, and serological evidence of infection was obtained in a patient who suffered meningoencephalitis in Yugoslavia.

Kasokero virus was isolated from fruit bats in Uganda, and caused four laboratory infections marked by febrile illness, headache, myalgia, arthralgia, abdominal pain, diarrhoea, chest pain, cough, as well as hyperactive reflexes in one patient. *Bangui virus* was isolated from the blood of a patient with febrile illness, headache and rash in the Central African Republic, and antibody was found in the sera of local residents.

Issyk-Kul virus was isolated from several species of insectivorous bat and from argasid tick parasites of bats, birds and anopheline and aedine mosquitoes in the Central Asian Republics of the former USSR. It was demonstrated that aedine mosquitoes and argasid ticks are able to transmit the virus. Antibody was found in human sera and virus was isolated on at least 19 occasions from the blood of persons suffering from febrile illness with headache, dizziness, cough, nausea and vomiting. The cases included laboratory infections. *Keterah virus*, isolated from argasid tick parasites of bats and from bat blood in Malaysia, has been shown to be closely related or identical to *Issyk-Kul virus*. It is difficult to be certain whether the natural vectors of *Issyk-Kul/Keterah virus* are argasid ticks or mosquitoes.

Tataguine virus has been isolated from anopheline mosquitoes in Senegal, Nigeria, Cameroon and Central African Republic. It appears to be a potentially important pathogen: antibody has been found in human sera in Senegal and Nigeria, and there have been at least 31 isolations of the virus from the blood of febrile humans in Senegal, Nigeria, Central African Republic and Cameroon. The infections

Table 18.6 Abridged classification of possible members of the family *Bunyaviridae*. Information derived from sources cited in the text

Serogroup ANTIGENIC COMPLEX Virus	Putative vectors	Human infection		Distribution
		Natural	Laboratory	
Bhanja BHANJA (3) ^a <i>Bhanja</i>	Ixodids	+	+	Europe, Africa, Asia
Yogue YOGUE (2) <i>Kasokero</i>	Unknown		+	Africa
Six other serogroups (17) Ungrouped (22) <i>Bangui</i>	Unknown	+		Africa
<i>Issyk-Kul (Keterah)</i>	Mosquitoes?	+	+	Asia
<i>Tataguine</i>	Mosquitoes	+		Africa
<i>Wanowrie</i>	Ixodids	+		Africa, Asia

^aFigures in parentheses indicate the total numbers of recognized members of the relevant taxon.

were characterized by febrile illness with headache, rash and arthralgia.

Wanowrie virus has been isolated from *Hyalomma* ticks in India, Iran and Egypt. Little else is known about the virus except that it was isolated in Sri Lanka from the brain of a human patient who succumbed to febrile illness with abdominal pain, vomiting, haematemesis and passing of blood per rectum.

REFERENCES

- Anderson, G.W., Jr and Smith, J.F. (1987) Immunoelectron microscopy of Rift Valley fever viral morphogenesis in primary rat hepatocytes. *Virology*, **161**, 91–100.
- Anonymous (1967) *Arboviruses and Human Disease*. Technical Report Series No. 369. World Health Organization, Geneva.
- Anonymous (1993) Rift Valley fever. *Weekly Epidemiological Record*, **68**, 300–301.
- Anonymous (1994) Rift Valley fever. *Weekly Epidemiological Record*, **69**, 74–75.
- Anonymous (1998) An outbreak of Rift Valley fever, Eastern Africa, 1997–1998. *Weekly Epidemiological Record*, **73**, 105–109.
- Arthur, R.R., Lofts, R.S., Gomez, J. *et al.* (1992) Grouping of hantaviruses by small (S) genome segment polymerase chain reaction and amplification of viral RNA from wild-caught rodents. *American Journal of Tropical Medicine and Hygiene*, **47**, 210–224.
- Arthur, R.R., El-Sharkawy, M.S., Cope, S.E. *et al.* (1993) Recurrence of Rift Valley fever in Egypt. *Lancet*, **342**, 1149–1150.
- Bishop, D.H.L. (1990) Bunyaviridae and their replication. Part I: Bunyaviridae. In *Virology* 2nd edn (eds B.N. Fields and D.M. Knipe), pp 1155–1173. Raven Press, New York.
- Bishop, D.H.L., Calisher, C.H., Casals, J. *et al.* (1980) Bunyaviridae. *Intervirology*, **14**, 125–143.
- Botros, B.A., Swanepoel, R., Graham, R.R. *et al.* (1997) Genetic characterization of Rift Valley fever isolates from the 1997 and 1993–1994 outbreaks in Egypt. *Abstracts of the 46th Annual Meeting of the American Society of Tropical Medicine and Hygiene*, Colorado Springs Resort, Lake Buena Vista, Florida, December 7–11, 1997.
- Bremner, J.A.G. (1994) Hantavirus infections and outbreaks in 1993. *Communicable Disease Report*, **4**, R5–9.
- Calisher, C.H. (1991) Bunyaviridae. *Archives of Virology*, **121** (suppl 2), 273–283.
- Calisher, C.H. and Karabatsos, N. (1989) Arbovirus serogroups: definition and geographic distribution. In *The Arboviruses: Epidemiology and Ecology* vol. I (ed. T.P. Monath), pp 19–57. CRC Press, Boca Raton, Florida.
- Casals, J. (1957) The arthropod-borne group of animal viruses. *Transactions of the New York Academy of Sciences*, **19**, 219–235.
- Casals, J. (1961) Procedures for identification of arthropod-borne viruses. *Bulletin of the World Health Organisation*, **24**, 727–734.
- Casals, J. and Whitman, L. (1960) A new antigenic group of arthropod-borne viruses. The Bunyamwera group. *American Journal of Tropical Medicine and Hygiene*, **9**, 73–77.
- Casals, J. and Whitman, L. (1961) Group C. A new serological group of hitherto undescribed arthropod-borne viruses. Immunological studies. *American Journal of Tropical Medicine and Hygiene*, **10**, 250–258.
- Chu, Y.-K., Rossi, C., LeDuc, J. *et al.* (1994) Serological relationships among viruses in the *Hantavirus* genus, family *Bunyaviridae*. *Virology*, **198**, 196–204.
- Chu, Y.-K., Jennings, G., Schmaljohn, C. *et al.* (1995) Cross-neutralization of hantaviruses with immune sera from experimentally-infected animals and from hemorrhagic fever with renal syndrome and hantavirus pulmonary syndrome patients. *Journal of Infectious Diseases*, **172**, 1581–1584.
- Chumakov, M.P. (1974) [Contribution to 30 years of investiga-

- tion of Crimean haemorrhagic fever]. In *Medical Virology* (ed. Chumakov, M.P.) vol. 22, pp 5–18. *Trudy Inst. Polio. Virus. Entsef. Akad. Med. Nauk SSSR*. [In Russian. English translation: NAMRU3-T950].
- Chung, S.I., Livingston, C.W., Jr, Edwards, J.F. *et al.* (1990a) Evidence that Cache Valley virus induces congenital malformations in sheep. *Veterinary Microbiology*, **21**, 297–307.
- Chung, S.I., Livingston, C.W. Jr, Edwards, J.F., Gauer, B.B. and Collisson, E.W. (1990b) Congenital malformations in sheep resulting from in utero inoculation of Cache valley virus. *American Journal of Veterinary Research*, **51**, 1645–1648.
- Duchin, J.S., Koster, F.T., Peters, C.J. *et al.* (1994) Hantavirus pulmonary syndrome: a clinical description of 17 patients with a newly recognized disease. *New England Journal of Medicine*, **330**, 949–955.
- Easterday, B.C. (1965) Rift Valley fever. *Advances in Veterinary Science*, **10**, 65–127.
- Feldmann, H., Sanchez, A., Morzunov, S. *et al.* (1993) Utilization of autopsy RNA for the synthesis of the nucleocapsid antigen of a newly recognized virus associated with hantavirus pulmonary syndrome. *Virus Research*, **30**, 351–367.
- Fenner, F. (1976) Classification and nomenclature of viruses. Second Report of the International Committee on Taxonomy of Viruses. *Intervirology*, **7**, 1–116.
- Foggin, C.M. and Swanepoel, R. (1977) Unpublished observations. Veterinary Research Laboratory, Causeway, Harare, Zimbabwe.
- Gonzalez-Scarano, F. and Nathanson, N. (1990) Bunyaviruses. In *Virology* 2nd edn (eds B.N. Fields and D.M. Knipe), pp 1195–1228. Raven Press, New York.
- Grankvist, O., Juto, P., Settergren, B. *et al.* (1992) Detection of nephropathia epidemica virus RNA in patient samples using a nested primer-based polymerase chain reaction. *Journal of Infectious Diseases*, **165**, 934–937.
- Grimstad, P.R., Calisher, C.H., Harroff, R.N. and Wentworth, B.B. (1986) Jamestown Canyon virus (California serogroup) is the etiologic agent of widespread infection of Michigan humans. *American Journal of Tropical Medicine and Hygiene*, **35**, 376–386.
- Henning, M.W. (1956) (ed.) Rift Valley fever. In *Animal Diseases in South Africa* 3rd edn, pp 1105–1121. Central News Agency Ltd, Cape Town.
- Hoogstraal, H. (1979) The epidemiology of tick-borne Crimean-Congo haemorrhagic fever in Asia, Europe and Africa. *Journal of Medical Entomology*, **15**, 307–417.
- Hoogstraal, H. (1981) Changing patterns of tick-borne diseases in modern society. *Annual Review of Entomology*, **26**, 75–99.
- Johnson, B.K., Chanas, A.C., Squires, E.J. *et al.* (1978) The isolation of a Bwamba virus variant from man in western Kenya. *Journal of Medical Virology*, **2**, 15–20.
- Kalunda, M., Lwanga-Ssozi, C., Lule, M. and Mukuye, A. (1985) Isolation of Chikungunya and Pongola viruses from patients in Uganda. *Transactions of the Royal Society for Tropical Medicine and Hygiene*, **79**, 567.
- Kanerva, M., Mustonen, J. and Vaheri, A. (1998) Pathogenesis of Puumala and other hantavirus infections. *Reviews in Medical Virology*, **8**, 67–86.
- Karabatsos, N. (ed.) (1985) *International Catalogue of Arboviruses including Certain Other Viruses of Vertebrates* 3rd edn. American Society of Tropical Medicine and Hygiene, San Antonio.
- Lee, H.W. (1982) Korean haemorrhagic fever. *Progress in Medical Virology*, **28**, 96–113.
- Linthicum, K.J., Davies, F.G. and Kaairo, A. (1985) Rift Valley fever virus (family Bunyaviridae, genus *Phlebovirus*). Isolations from Diptera collected during an inter-epizootic period in Kenya. *Journal of Hygiene*, **95**, 197–209.
- McKee, K.T. Jnr, LeDuc, J.W. and Peters, C.J. (1991) Hantaviruses. In *Textbook of Human Virology* 2nd edn (ed. R.B. Belshe), pp 615–632. Mosby Year Book, St Louis.
- Matthews, R.E.F. (1981) The classification and nomenclature of viruses: summary of results of meetings of the International Committee on Taxonomy of Viruses in Strasbourg, August, 1981. *Intervirology*, **16**, 53–60.
- Meegan, J.M. and Bailey, C.L. (1989) Rift Valley fever. In *The Arboviruses: Epidemiology and Ecology* vol. IV (ed. T.P. Monath), pp 51–76. CRC Press, Boca Raton, Florida.
- Monroe, M.C., Morzunov, S.P., Johnson, A.M. *et al.* (1999) Genetic diversity and distribution of *Peromyscus*-borne hantaviruses in North America. *Emerging Infectious Diseases*, **5**, 75–86.
- Murphy, F.A., Harrison, A.K. and Whitfield, S.G. (1973) Bunyaviridae: morphological and morphogenetic similarities of bunyamwera serologic supergroup viruses and several other arthropod-borne viruses. *Intervirology*, **1**, 297–316.
- Murphy, F.A., Fauquet, C.M., Bishop, D.H.L. *et al.* (1995) Virus Taxonomy—Classification and Nomenclature of Viruses. Sixth Report of the International Committee on Taxonomy of Viruses. *Archives of Virology*, **140** (suppl. 10).
- Nichol, S.T., Spiropoulou, C.F., Morzunov, S. *et al.* (1993) Genetic identification of a hantavirus associated with an outbreak of acute respiratory illness. *Science*, **262**, 914–917.
- Peters, C.J. and LeDuc, J.W. (1991) Bunyaviridae: bunyaviruses, phleboviruses and related viruses. In *Textbook of Human Virology* 2nd edn (ed. R.B. Belshe), pp 571–614. Mosby Year Book, St Louis.
- Peters, C.J. and Meegan, J.M. (1981) Rift Valley fever. In *CRC Handbook Series in Zoonoses* Sect. B, vol. I (ed. G. Beran), pp 403–419. CRC Press, Boca Raton, Florida.
- Porterfield, J.S. (1990) Alphaviruses, Flaviviruses and Bunyaviridae. In *Principles and Practice of Clinical Virology* 2nd edn (eds A.J. Zuckerman, J.E. Banatvala and J.R. Pattison), pp 434–448. Wiley, Chichester.
- Porterfield, J.S., Casals, J., Chumakov, M.P. *et al.* (1974) Bunyaviruses and Bunyaviridae. *Intervirology*, **2**, 270–272.
- Puthavathana, P., Lee, H.W. and Yong Kang, C. (1992) Typing of hantaviruses from five continents by polymerase chain reaction. *Virus Research*, **26**, 1–14.
- Reeves, W.C. (1974) Overwintering of arboviruses. *Progress in Medical Virology*, **17**, 193–220.
- Schmaljohn, C. and Hjelle, B. (1997) Hantaviruses: a global disease problem. *Emerging Infectious Diseases*, **2**, 95–104.
- Schmaljohn, C.S. and Patterson, J.L. (1990) Bunyaviridae and their replication. Part II: Replication of Bunyaviridae. In *Virology* 2nd edn (eds B.N. Fields and D.M. Knipe), pp 1175–1194. Raven Press, New York.
- Schmaljohn, C.S. and Hasty, S.E., Dalrymple, J.M. and LeDuc, J.W. (1985) Antigenic and genetic properties place viruses linked to hemorrhagic fever with renal syndrome into a newly defined genus of Bunyaviridae. *Science*, **227**, 1041–1044.
- Shimshony, A. and Barzilai, R. (1983) Rift Valley fever. *Advances in Veterinary Science and Comparative Medicine*, **27**, 347–425.

- Shope, E. and Sather, G.E. (1979) Arboviruses. In *Diagnostic Procedures for Viral, Rickettsial and Chlamydial Infections* 5th edn (eds E.H. Lennette and N.J. Schmidt), pp 767–814. American Public Health Association, Washington, DC.
- Simons, J.F., Hellmann, U. and Petterson, R.F. (1990) Uukuniemi virus S RNA segment: ambisense coding strategy, packaging of complementary strands into virions, and homology to members of the genus Phlebovirus. *Journal of Virology*, **64**, 247–255.
- Swanepoel, R. (1994) Classification, epidemiology and control of arthropod-borne viruses. In *Infectious Diseases of Livestock with Special Reference to Southern Africa* (eds J.A.W. Coetzer, G.R. Thomson and R.C. Tustin), *in press*. Oxford University Press Southern Africa, Cape Town.
- Swanepoel, R. and Coetzer, J.A.W. (1994) Rift Valley fever. In *Infectious Diseases of Livestock with Special Reference to Southern Africa* (eds J.A.W. Coetzer, G.R. Thomson and R.C. Tustin), *in press*. Oxford University Press Southern Africa, Cape Town.
- Swanepoel, R., Shepherd, A.J., Leman, P.A. *et al.* (1987) Epidemiologic and clinical features of Crimean-Congo haemorrhagic fever in southern Africa. *American Journal of Tropical Medicine and Hygiene*, **36**, 120–132.
- Swanepoel, R., Gill, D.E., Shepherd, A.J. and Leman, P.A. (1989) The clinical pathology of Crimean-Congo hemorrhagic fever. *Reviews of Infectious Diseases*, **11**, S794–800.
- Tesh, R.B. (1984) Transovarial transmission of arboviruses in their invertebrate vectors. In *Current Topics in Vector Research* vol. II (ed. K.F. Harris), pp 57–76. Praeger Publishers, New York.
- Watts, D.M., Ksiazek, T.G., Linthicum, K.J. and Hoogstraal, H. (1989) Crimean-Congo haemorrhagic fever. In *The Arboviruses: Epidemiology and Ecology* vol. II (ed. T.P. Monath), pp 177–222. CRC Press, Boca Raton, Florida.
- Weiss, K.E. (1957) Rift Valley fever: a review. *Bulletin of Epizootic Diseases of Africa*, **5**, 431–458.
- Wells, R.M., Estani, S.S., Yadon, Z.E., Enria, D., Padula, P., Pini, N., Mills, J.N., Peters, C.J. and Segura, E.L. (1997) An unusual hantavirus outbreak in southern Argentina: person-to-person transmission? *Emerging Infectious Diseases*, **2**, 171–174.
- Xiao, S-Y., Chu, Y-K., Knauert, F.K. *et al.* (1992) Comparison of hantavirus isolates using a genus-reactive primer pair polymerase chain reaction. *Journal of General Virology*, **73**, 567–573.
- Xiao, S-Y., LeDuc, J.W., Chu, Y.K. *et al.* (1994) Phylogenetic analyses of virus isolates in the genus *Hantavirus*, family *Bunyaviridae*. *Virology*, **198**, 205–217.

Arenaviruses

Colin R. Howard

Royal Veterinary College, London, UK

INTRODUCTION

The arenaviruses are a group of enveloped, single-stranded RNA viruses, the study of which has been pursued for two quite separate reasons. First, *Lymphocytic choriomeningitis (LCM) virus* has been used as a model of persistent virus infections for over half a century; its study has contributed a number of cardinal concepts to our present understanding of interactions between viruses and the host immune system. Although LCM infections of humans are rare, this virus remains the prototype of the *Arenaviridae* and is a common infection of laboratory mice, rats and hamsters. Second, certain arenaviruses cause severe haemorrhagic diseases in humans, notably Lassa fever in Africa and Argentine haemorrhagic fever in South America. More recently, several new arenaviruses have been described from South America, two of which are associated with human infections. In common with LCM, the natural reservoir of these infections is a limited number of rodent species (Howard, 1986). Although the initial isolates from South America were at first erroneously designated as newly defined arboviruses, there is no evidence to implicate arthropod transmission for any arenavirus. However, similar methods of isolation and the necessity of trapping small animals have meant that the majority of arenaviruses have been isolated by workers in the arbovirus field. A good example of this is the recently identified *Guanarito virus* that emerged during investigation of a dengue virus outbreak in Venezuela (Salas *et al.*, 1991). With the current con-

cern about the so-called 'emerging viruses', the arenaviruses are a good illustration as to how environmental changes may result in an altered balance between human and natural animal hosts, leading to unexpected diseases which can severely challenge local and national public health resources.

There is an interesting spectrum of pathological processes associated with these viruses that give useful insights into other zoonotic infections. All the evidence so far available suggests that the morbidity of Lassa fever and South American haemorrhagic fevers due to arenavirus infection results from the direct cytopathic action of these agents. This is in sharp contrast to the immunopathological basis of 'classic' lymphocytic choriomeningitis disease seen in adult mice infected with LCM virus. For a general overview of the arenaviruses, see Salvato (Salvato, 1993) and *Field's Virology* (Peters *et al.*, 1996; Southern, 1996).

PROPERTIES OF THE VIRUS

Nomenclature and Natural History

The morphological, physicochemical and serological properties of the arenaviruses were first summarized by Pfau (Pfau, 1974). The members of the family are listed in Table 19.1. The various strains and isolates of LCM are now considered to be a genus within the family *Arenaviridae*. A close serological relationship exists between LCM, *Lassa*

Table 19.1 The arenaviruses: host and geographical distribution

Virus	Natural host	Human disease	Distribution
<i>Worldwide</i>			
Lymphocytic choriomeningitis	<i>Mus musculus</i> , <i>M. domesticus</i>	Aseptic meningitis	Europe, N. and S. America
<i>Old World</i>			
Lassa	<i>Mastomys natalensis</i>	Lassa fever	West Africa
Mopeia	<i>Mastomys natalensis</i>	Infection possible	Mozambique, Zimbabwe
Mobala	<i>Praomys jacksoni</i>	Infection possible	Central African Republic
Ippy	<i>Arvicanthus spp.</i>	?	Central African Republic
<i>New World</i>			
Machupo	<i>Calomys callosus</i>	Bolivian haemorrhagic fever	Bolivia
Junin	<i>Calomys musculimus</i> , <i>C. laucha</i> <i>Akadon azarae</i>	Argentinian haemorrhagic fever	Argentina
Sabia	?	Brazilian haemorrhagic fever	Brazil
Guanarito	<i>Sigmodon alstoni</i> , <i>Zygodontomys brevicuda</i>	Venezuelan haemorrhagic fever	Venezuela
Tacaribe Amapari	<i>Artibeus literatus (bat)</i> <i>Oryzomys gaedi</i> , <i>Neocomys guianae</i>	Infection possible	Trinidad
Pichinde	<i>Oryzomys albicularis</i>	Not recorded	Columbia
Tamiami	<i>Sigmodon hispidus</i>	Not recorded	Florida, USA
Latino	<i>Calomys callosus</i>	Not recorded	Bolivia
Flexal	<i>Neocomys spp.</i>	Not recorded	
Parana	<i>Oryzomys buccinatus</i>	Not recorded	
Oliveros	<i>Bolomys obscurus</i>	Not recorded	Argentina

virus and other arenaviruses from Africa. For this reason, they are loosely referred to as the 'Old World' arenaviruses, in contrast to those from the Americas, although now LCM can be found worldwide except in Australia (Howard and Simpson, 1980). The 'New World' arenaviruses show varying degrees of serological relationships with *Tacaribe virus*, first isolated in Trinidad. For this reason, viruses from the Americas are frequently regarded as members of the Tacaribe complex.

The *Arenaviridae* take their name from the sand-sprinkled appearance when viewed in the electron microscope (Latin *arena* = sand). With the exception of LCM, all are referred to by names that reflect the geographical area in which they were isolated (Figure 19.1). Various strain designations are also commonly used, in particular for LCM and arenaviruses isolated from humans. Multiple isolations of non-pathogenic viruses that infect New World rodents are made less frequently, with the

exception of *Pichinde virus* where a large number of field isolates from Colombia have been characterized.

Nearly all 17 members of the *Arenaviridae* so far described have rodents as their natural reservoir hosts. Although rodents are divided into over 30 families distributed worldwide, arenaviruses are predominantly found within two major families: *Muridae* (e.g. mice and rats) and *Cricetidae* (e.g. voles, lemmings, gerbils). The nature of the original reservoir for LCM virus remains obscure, but it appears to be mainly in species of the *Muridae* which evolved in the Old World and subsequently spread to most parts of the globe. Interestingly, there is a wide range of tropism and virulence among laboratory strains of LCM virus originally isolated from laboratory mouse colonies.

The natural reservoir of *Lassa virus* and the remaining Old World arenaviruses is the peridomestic rodent *Mastomys natalensis*. This is also a mem-

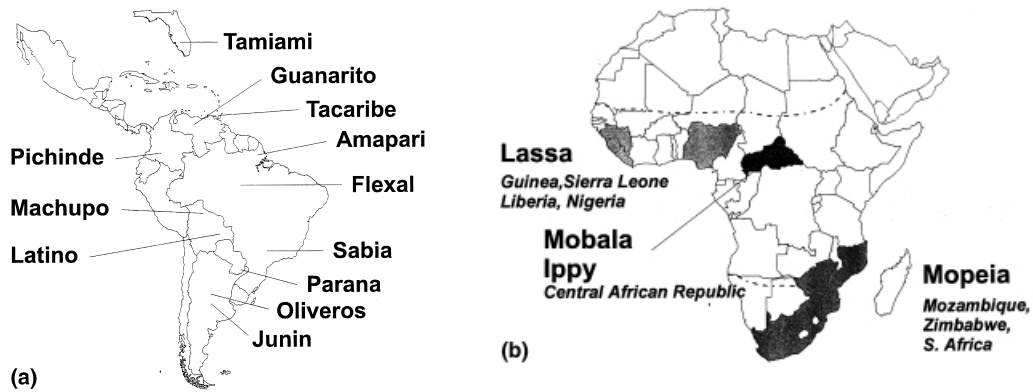

Figure 19.1 Geographical distribution of (a) Old and (b) New World arenaviruses

ber of the *Muridae* and, in common with the host of LCM, frequents human dwellings and food stores. In contrast, nearly all arenaviruses isolated from the South American continent are associated with cricetid rodents whose members frequent open grasslands and forest. The exception is *Tacaribe virus*, which was originally isolated from the fruit-bat, *Artibeus literatus*.

Ultrastructure of Arenaviruses and Infected Cells

Negative-staining electron microscopy of extracellular virus shows pleomorphic particles ranging in diameter from 80 to 150 nm (Figure 19.2). The virus envelope is formed from the plasma membrane of infected cells. A significant thickening of both bilayers of the membrane together with an increase in the width of the electron-translucent intermediate layer is characteristic of arenavirus development. Little is known about the internal structure of the arenavirus particle, although thin sections of mature and budding viruses clearly show the ordered, and often circular, arrangements of host ribosomes that are typical of this virus group and confer the 'sandy' appearance from which its name is derived. Distinct well-dispersed filaments 5–10 nm in diameter are released from detergent-treated virus. Two predominant size classes are present, with average lengths of 649 nm and 1300 nm, respectively; these lengths do not show a close relationship with the two virus-specific L and S RNA species. Each is circular and beaded in appearance. Convoluted

filamentous strands up to 15 nm in diameter can be seen in preparations of spontaneously disrupted Pichinde virus. These appear to represent globular condensations which arise from an association between neighbouring turns of the underlying helix. The basic configuration of the filaments shows a linear array of globular units up to 5 nm in diameter, probably representing single molecules of the viral polypeptide. These filaments progressively fold through a number of intermediate helical structures to produce the stable 15 nm diameter forms (Young, 1987).

Arenaviruses replicate in experimental animals in the absence of any gross pathological effect. However, cellular necrosis may accompany virus production, not unlike that seen in virus-infected cell cultures. The variable pathological changes associated with arenavirus infections are further complicated by the occasional appearance of particles in tissue sections that react strongly with fluorescein-conjugated antisera. Granular fluorescence with convalescent serum in the perinuclear region of acutely infected Vero cells is often seen. In addition, intracytoplasmic inclusion bodies are a prominent feature in virus-infected cells both *in vitro* and *in vivo*. These usually appear early in the replication cycle and consist largely of single ribosomes which later become condensed in an electron-dense matrix, sometimes together with fine filaments (Murphy and Whitfield, 1975).

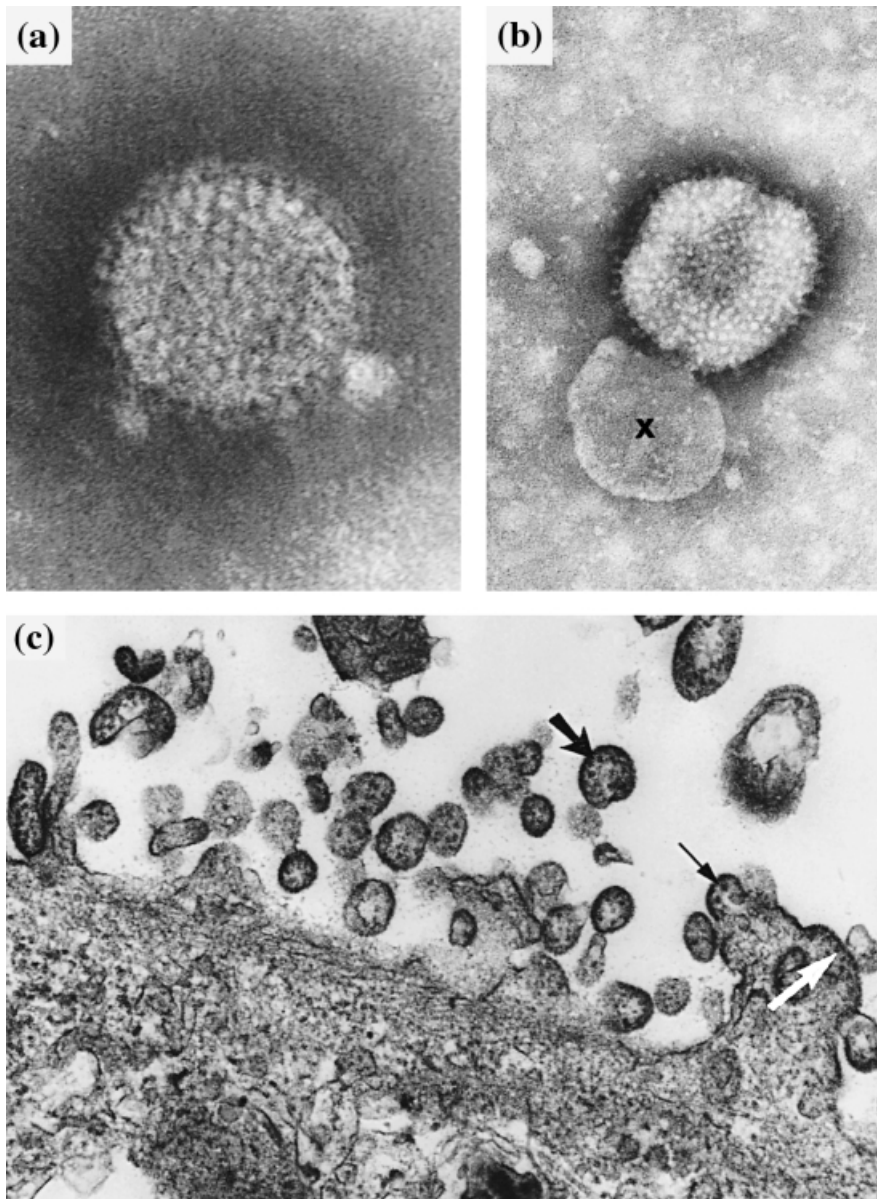

Figure 19.2 Electron microscopy of arenaviruses. (a) Negatively stained Lassa fever particle showing the whole surface covered in projections. Few particles are less than 100 nm, and many are twice this size. ($\times 300\,000$) (b) *Mopeia virus* from southern Africa. Here the negative stain has disrupted the particle, the contents of which (x) have been extruded. ($\times 150\,000$) (c) Lassa fever particles budding from an infected Vero cell. The thick arrow shows a mature particle, the thin arrow a maturing particle at the plasmalemma. Nucleocapsids and ribosomes line up immediately below the thickened membrane (white arrow). ($\times 39\,000$)

Chemical Composition

Proteins

All arenaviruses contain a major nucleocapsid associated protein of molecular weight 54–68 kDa with

two glycoproteins in the outer viral envelope. These envelope glycoproteins are not primary gene products but arise by proteolytic cleavage of a larger, 75 kDa glycoprotein precursor polypeptide (GPC). Maturation and release of virus do not seem to be markedly inhibited in the presence of tunicamycin,

an inhibitor of glycosylation; glycoprotein processing appears to be essential for infectivity, however.

The major glycoprotein species (GP2) in the molecular weight range of 34-42 kDa represents the C-terminal cleavage product of the GPC envelope glycoprotein precursor. A major antigenic site has been located between amino acids 390 and 405, and cross-reactive monoclonal antibodies bind to epitopes in this region. The corresponding N-terminal product of GPC cleavage (GP1) is probably highly glycosylated with at least four antigenic domains. Neutralizing monoclonal antibodies to LCM virus map to two of these regions and there is less sequence homology between the GP1 than between the GP2 molecules of different arenaviruses. Polyclonal neutralizing antibody appears to react predominantly with conformation-dependent structures within one of these domains. Until recently, a puzzling feature of arenavirus structure was finding a single glycoprotein in the envelopes of Tacaribe and Tamiami viruses. This is despite the close relationship known to exist between *Tacaribe* and *Junin viruses*, the latter possessing the more typical duplex of envelope glycoproteins, and sequence analysis predicting the existence of a GP1 glycoprotein. This issue has now been resolved, however, with the identification of a second, similarly sized glycoprotein in the outer envelope of Tacaribe virus.

The internal nucleocapsid-associated (N) protein accounts for much of the virus-specific protein present in purified virus and infected cells, and remains bound to the virus genome after solubilization of the virus with non-ionic detergents. Molecular cloning studies have shown a surprisingly high degree of homology between the N proteins of Old and New World arenaviruses. This would account for the serological cross-reactions seen using certain monoclonal antibodies raised against such epidemiologically distinct viruses and may indicate precise functional roles in virus replication for certain domains of the N polypeptide. Cleavage products of the N protein are a consistent feature of both virus and virus-infected cells. Cleavage is not noticeable in Vero cells; yields of arenaviruses are lower in these cells, perhaps due to reduced availability of N for packaging. A fragment of the N protein is often seen in the nucleus of these cells, although the exact function of this is not clear.

A minor component with a molecular weight in excess of 150 kDa is often observed in infected cells.

This L protein is coded by the larger RNA genome segment, as shown by the study of reassortant viruses. This large protein is considered to be the virus-specific RNA polymerase (Fuller-Pace and Southern, 1989). Amino acid sequences common to the viral polymerase are present along the open reading frame coding for the L protein, which suggests the conservation of certain functional domains. A small, 12 kDa viral polypeptide, the so-called Z protein, is considered to play a role in controlling the replication and expression of the genome owing to its zinc-binding properties.

Nucleic Acid

The genome of arenaviruses consists of two single-stranded RNA segments of different sizes, designated L and S. Analysis of RNA is complicated by the presence of ribosomal 18S and 28S RNA, although these cellular RNA species are not essential for virus replication; the level of radioactivity incorporated into the two viral RNA species is markedly reduced in the presence of low concentrations of actinomycin D. The total ribosomal RNA content may in turn be influenced by the varying proportions of infectious to non-infectious particles present in virus stocks. The role for these host RNA molecules in the establishment and maintenance of persistent infections is unresolved (see Replication, below).

Extracted virion RNA is not infectious and the detection of a viral RNA polymerase led to the belief that arenaviruses adopt a negative-strand coding strategy with respect to viral protein synthesis. Complete molecular sequence data confirm that each species is unique, with an established total protein coding capacity of between 250 and 300 kDa from the L strand and 125 and 150 kDa from the S RNA. Studies that exploit the high frequency of recombination typical of segmented viral genomes have permitted the assignment of the N and GPC genes to the S strand.

Genetic studies have shown that the S strand codes for the nucleoprotein (N) and the envelope glycoprotein precursor (GPC) in two main open reading frames located on RNA molecules of opposite polarity. The 3' half of the S RNA codes for the N protein by production of an mRNA with a viral-sense sequence specific for the GPC protein. Thus expression of the genome is by synthesis of sub-genomic RNA from full-length templates of oppo-

site polarities. This strategy of 'ambisense' coding for viral protein has so far been described only for the arenaviruses and some bunyaviruses. The reading frames for the two major gene products are separated by a hairpin structure of approximately 20 paired nucleotides. This intergenic region may act as a control mechanism for genome expression but there is as yet no experimental evidence to support this possibility.

The L RNA strand represents about 70% of the viral genome; reassortment studies with virulent and avirulent strains of LCM virus have shown that lethal disease in guinea-pigs is associated with the L RNA strand. The L protein is encoded by a large open reading frame covering 70% of the L RNA strand: it is expressed via mRNA complementary in sense to the viral genome.

Replication

Arenaviruses replicate in a wide variety of mammalian cells, although either BHK-21 cells or monkey kidney cell lines are used for biochemical studies (Howard, 1986). Most arenaviruses also grow well in mouse L cells but the simultaneous production of C-type retroviruses restricts the usefulness of such cells. Maximal virus adsorption to cell surfaces is at 2 hours at 37°C. At low multiplicities of infection (i.e. below 0.1) the latent period is approximately 6–8 hours, after which cell-associated virus increases exponentially. The titre of extracellular virus reaches a maximum 36–48 hours after infection. The passage history of any particular virus stock is probably one of the most critical factors which determines the kinetics of arenavirus replication.

Infected cells undergo only limited cytopathic changes in the cell lines commonly employed, with little or no change in the total level of host cell protein synthesis; virus yields vary in different susceptible cell types. Cultures of persistently infected cells are readily established, the morphology and growth kinetics of which are similar to those of uninfected cells.

Only limited information is available concerning the replication and expression of viral RNA within infected cells, although possible replication events can be predicted from the nucleotide sequences of L and S genome segments. The major feature of an

ambisense coding strategy is that it allows for independent expression and regulation of the N and GPC genes from the S RNA segment. The N protein is independently expressed late in acute infection and in persistently infected cells in the absence of low levels of glycoprotein production. This is explained by the production of subgenomic mRNA from a negative polarity, virus-sense template. A control mechanism must therefore exist which determines the fate of nascent RNA of negative polarity, destined either for encapsidation or as a template for N protein-specific mRNA. In contrast, the template for glycoprotein-specific mRNA is of complementary sense to viral RNA and as such would not be required for nascent virus production. The lack of glycoprotein late in the replicative cycle or in persistently infected cells would therefore imply selective transcriptional or translational control of this gene product.

Both viral RNA and its complementary strand contain hairpin sequences which may provide recognition points for termination of transcription by viral RNA polymerase. The nucleotide sequence in the hairpin region is of coding sense and may be transcribed, either as a discrete mRNA species or as a result of extended transcription of N or GPC messengers through this region. The postulated reading frames for viral gene products transcribed from LCM and Pichinde viral genomes would fit this hypothesis. In addition, a sequence for ribosomal 18S subunit binding is present on both mRNA molecules, although the significance of this is not clear.

DIAGNOSIS OF ARENAVIRUS INFECTIONS

The diagnosis of arenavirus infections may be made by demonstration of a fourfold rise in specific antibody titre, the presence of specific IgM antibodies, or isolation of the virus. Although arenaviruses can easily be grown in a variety of mammalian cell cultures, it must be remembered that clinical specimens from patients suspected of having a viral haemorrhagic fever should always be handled in biologically secure containment facilities. For this reason tests for antibody are more widely useful because inactivated viral antigens for serology can be prepared easily. For routine isolation, the E6 clone

of Vero cells is the cell line of choice, although all arenaviruses grow well in primate and rodent-derived fibroblast cell lines. However, a cytopathic effect (CPE) is often difficult to see, and inoculated cultures often require examination by immunofluorescence (IF) or enzyme-linked immunosorbent assay (ELISA) in order to detect the presence of viral antigens.

IF-based specific viral antibody tests are now the preferred method for the diagnosis of human arenavirus infections. In the case of Lassa fever, infected cell substrates are used that have been treated by ultraviolet (UV) light, acetone and cobalt irradiation to ensure safety. Drops of cell cultures dried on to glass slides can be prepared in a central laboratory and these preparations remain stable for many months. Most of the antigen detected within acetone-fixed infected cells represents cytoplasmic nucleocapsid protein. In the case of the New World arenaviruses, serological cross-reactions in the IF test (e.g. with sera from patients with Bolivian (Machupo) and Argentinian (Junin) haemorrhagic fevers) are found with fixed cultures. Substrates prepared from other members of the Tacaribe complex, which includes *Junin* and *Machupo* viruses, also react with sera taken from these patients during the acute phase and early convalescence. Greatest cross-reactivity is seen between the closely related Junin and Machupo antigens, closely followed by Tacaribe virus-infected cells. ELISA has been used as an alternative to IF for early and rapid diagnosis although its use is restricted by the small amounts of antigen available for coating the solid phase.

ANTIGENIC RELATIONSHIPS

Each member of the *Arenaviridae* is antigenically related to other members of the group, although the degree of cross-reactivity depends on the assay system used. The complement fixation (CF) test reveals the broadest relationship (Casals, 1975). A particularly strong relationship between *Tacaribe*, *Junin* and *Machupo* viruses can be readily demonstrated by CF, with more distant cross-reactivity being discernible between these viruses and other members of the Tacaribe complex, although *Pichinde* and *Tamiami* viruses are not so closely related to each other or to other New World arenaviruses (Casals *et al.*, 1975). With the CF test, LCM virus and *Lassa*

virus show some relationship to each other. All the available evidence suggests that the complement-fixing antigen is associated with the internal nucleoprotein.

Monoclonal antibodies are used to distinguish between virus strains because they can be prepared against epitopes which go unrecognized when polyclonal antisera are used. Buchmeier *et al.* (1981) summarized the patterns of reactivity with a panel of monoclonal antibodies directed against laboratory strains of the homologous LCM virus, and *Lassa* and *Mopeia* viruses. Antibodies directed against the smaller, GPC envelope glycoprotein cross-reacted by immunofluorescence with all substrates examined, whereas antibodies directed against the larger GP1 glycoprotein were either strain specific or reacted with a subset only of the strains examined, presumably by binding to previously unrecognized epitopes. The observation that certain of these broadly cross-reactive antibodies also reacted with *Pichinde virus* suggests that epitopes on surface envelope structures among Old World and New World arenaviruses are conserved. A similar comparison has also been undertaken with monoclonal antibodies to Lassa tested against the *Mopeia* and *Mobala* viruses from Africa. Again, various degrees of cross-reactivity were observed with reagents specific for the GP2 external glycoprotein. *Mobala virus* from the Central African Republic, however, appears to be distinct, as several cross-reactive monoclonal antibodies originally prepared against LCM virus failed to recognize *Mobala*-infected substrates. Clegg and Lloyd (1984) analysed an extensive range of different determinants common to all strains of both viruses on the internal nucleocapsid and on at least one of the two glycoproteins.

The plaque reduction neutralization test is highly specific for all members of the *Arenaviridae*; it is notable that the few examples of cross-reactivity were obtained with high-titre animal antisera raised against *Junin*, *Tacaribe* and *Machupo* viruses. However, the ease with which neutralizing antibodies can be quantified varies greatly. No cross-reactions have been observed between *Junin* and *Machupo* viruses in plaque reduction tests with human convalescent sera despite the close relationship demonstrable by CF. A similar marked specificity of neutralization has been demonstrated with LCM and Lassa sera, and another by this technique. The sensitivity of the neutralization test for LCM virus can

be increased by incorporating either complement or anti- γ -globulin into the test system. However, neutralizing antibodies to *Lassa virus* can be detected only with great difficulty.

CLINICAL AND PATHOLOGICAL ASPECTS

Immune Response

The classic example of virus-induced immunopathological disease is LCM virus infection of adult mice (Casals, 1975) in which intracerebral inoculation causes severe disease and death. In contrast, if mice are infected before or shortly after birth they develop a non-pathogenic lifelong carrier state. The newborn mouse is immunologically immature and the virus does stimulate an immune response; in these circumstances the virus causes no illness. The immunologically mature mouse mounts an immune response following LCM virus infection, and a fatal choriomeningitis results, but without evidence of neuronal damage (Lehmann-Grube, 1971). Immunosuppression, either by neonatal thymectomy or by use of antilymphocytic serum, protects adult mice against fatal LCM infection; the pathological damage thus appears to be cell mediated.

The immune responses are best understood in acute infection of mice. Intraperitoneal injection of adults gives rise to an asymptomatic acute infection of 2–3 weeks duration. Studies of such infections have resulted in a number of findings with implications beyond the field of arenavirus research. First, the description by Rowe (1954) of the immune-mediated pathology of acute LCM infection was the first demonstration that the pathogenicity of the viruses may not be solely related to their cytolytic effects. The observation that LCM virus infected cells were lysed by cytotoxic T cells led to the concept that recognition of a target cell requires the presence of both viral antigen and class I antigen of the host's major histocompatibility complex (Zinkernagel and Doherty, 1979). Secondly, the persistence of virus in mice infected shortly after birth has provided a model for both host and viral factors involved in the establishment and maintenance of chronic infection. The finding of virus antigen-antibody complexes in persistently infected animals shows that B cell tolerance is not involved. Finally,

activation of natural killer cell activity early in acute infection, which coincides with the production of interferon, has helped to increase our knowledge of innate immunity against virus infection.

The direct demonstration of virus replication in lymphocytes is of substantial importance for understanding arenavirus pathogenesis, as these cells provide a continued source of virus that enters the circulation and play a key role in the temporal and quantitative control of the immune response (Murphy and Whitfield, 1975). Viral antigen is present in the cells of the lymphatic system in mice persistently infected with LCM virus. Most of the virus in the blood of carrier mice is associated with approximately 2% of the total circulating lymphocyte population. Precursor or immature lymphocytes may support the replication *in vitro* of LCM virus when they are stimulated to proliferate by phytohaemagglutinin, in agreement with the general finding that arenaviruses grow best in actively dividing cells. Such clonal expansion may be triggered *in vivo* by viral antigen binding to appropriate lymphocyte receptors.

Arenaviruses can replicate in peritoneal and tissue macrophages. Virus can be recovered from mononuclear cells and macrophages of adult mice infected with LCM virus when these cells become activated as a result of the uptake of heterologous antigens. This does not occur in athymic mice, suggesting that infection of macrophages requires T cell activity.

Interferon

Interferon is induced early in acute LCM virus infection of mice, and its appearance correlates with the appearance of infectious virus in the blood. There have been few studies of the levels of α -interferon in acute arenavirus infection of humans. Elevated levels can be detected in the early stages of Argentinian haemorrhagic fever, and these coincide with the onset of fever and backache. Although there is no correlation between the titres of interferon and circulating virus, Levis and colleagues (Levis and Saavedra, 1984) have suggested that at least some of the clinical signs may be directly attributable to interferon, particularly the depression of platelet and lymphocyte numbers that result from Junin virus infection of leucocytes and macrophages. The role of natural killer cells in controlling arenavirus infection is not clear, although many are

found in the blood and spleen of LCM virus-infected mice as early as 1 day after infection. This response declines rapidly, however, until by the fourth day almost all the cytolytic immune activity is H-2 restricted.

Antibodies

Antibody against the nucleocapsid can be detected by CF and IF early in the acute phase of most arenavirus infections. Infectious virus-antibody complexes can be detected 4 days after LCM virus infection of mice but there is no evidence that B cell responses play a role in the pathology of the acute infection. Immunity to arenaviruses appears in general to be type specific; an infection with one member of the family does not necessarily confer protective humoral or cellular immunity against arenaviruses that can be distinguished by neutralization tests *in vitro*. However, cross-reactive antibodies may confer some degree of protection in some instances. For example, immunization of experimental animals with *Tacaribe virus* protects against subsequent challenge with the normally virulent *Junin virus*. These responses are clearly different from the anamnestic responses that may be induced as a result of antigenic similarities between nucleocapsid proteins of the two viruses concerned.

Cell-mediated Immunity

The role of cell-mediated immunity during acute LCM infection is manifested by a cytotoxic T cell response associated with the clearing of virus; for example, T cells cultured and cloned *in vitro* and injected intravenously reduce the amount of virus 100-fold in the spleens of acutely infected mice. Cytotoxic T cell responses are restricted by the need for activated T cells to recognize both viral antigen and host cell proteins encoded by the H-2 region, a concept developed in LCM-infected mice which has radically altered our concept of the mechanisms by which the infected host clears virus from infected tissues. The generation of specific cellular toxicity is related to the replication of the virus in target organs; inoculation with live virus appears necessary as a primary cytotoxic T cell response is not seen if the virus is inactivated. This has implications for the development of inactivated arenavirus vaccines should the stimulation of cellular immunity prove essential for protection. T cell clones from mice

infected with the Armstrong strain of LCM virus lyse a wide range of LCM virus strains. This finding demonstrates that cytotoxic responses to arenaviruses are haplotype restricted but show a broad cross-reactivity for conserved viral determinants. Some of these determinants have now been mapped to an immunodominant domain of GP2 between amino acids 278 and 286 (Whitton *et al.*, 1988). Such T cell clones can discriminate between cells infected with a given strain of virus containing only a single amino acid substitution in this region; this implies that mutations in this region of the genome may lead to selection of a virus variant with altered pathogenicity.

In contrast to LCM virus, the role of cell-mediated immunity in Lassa virus infection seems to play only a minor role. The human host is clearly restricted in its ability to clear the virus and prevent its replication in tissues, possibly because of impairment of cytotoxic T cell reactions. The poor neutralizing antibody response and the high degree of viraemia contrast sharply with those in patients with South American haemorrhagic fevers, in whom there is little viraemia and neutralizing antibodies develop rapidly during acute infection. The prospects of immunotherapy thus seem poor and greater emphasis is, therefore, placed on the use of antiviral agents.

Persistent Infection

Antibodies

Mice persistently infected with LCM virus produce antibodies to all the major structural proteins. This finding was contrary to the view previously held that viral persistence is established or maintained *in vivo* as a result of an absence of specific B cell responses to some or all viral antigens. As viral proteins continue to be produced in the tissues of such animals, circulating antigen-antibody complexes are formed which can be detected by binding Clq. It is worth noting that, despite the existence of antibody to all LCM virus structural polypeptides, sera from persistently infected mice are negative by CF tests; this was the original basis for the belief that carrier animals do not produce a humoral response to this virus. Antibody in the sera of such animals binds to the surface of virus-infected cells, but is unable to mediate complement-dependent

cytolysis, suggesting that viral antigens at the plasma membrane may be either masked, thereby preventing further immune reactions, or removed by antigenic modulation. This notion would imply that persistently infected mice are deficient in viral antibody of the complement fixing subclass of IgG, but this has not been proven.

Cell-mediated Immunity

Mice persistently infected with LCM virus should mount a normal T cell response to unrelated immunogens, indicating a state of tolerance only to specific antigens. However, it has been difficult to distinguish T cell suppression from an absence of virus-specific T cell clones. Here it is pertinent to mention that persistence of LCM virus in mice infected at birth or *in utero* was one of the important observations made by Burnet and Fenner to support the concept of tolerance to 'self' antigens. The time of infection is critical, as LCM infection induced 24 hours after birth results in a cytotoxic T cell response typical of acute disease. The failure of mice infected before this time to mount an adequate cytotoxic response is presumably related to maturation of T cell function; it appears to be virus specific because adult carrier mice challenged with other unrelated arenaviruses mount normal cytotoxic T cell responses. Thus the block appears to be either in recognition of infected cells, or in their expression of type-specific antigenic determinants. The relationship between the virus and the host immune response may be more complex than hitherto believed, however, as there is evidence for arenaviral RNA being transcribed into complementary DNA, presumably mediated by endogenous retroviral reverse transcriptase (Klenerman *et al.*, 1997). This would imply that long term persistence of viral gene sequences as retroviral elements results in continual low level expression of viral proteins. Thus immune responsiveness is maintained by the continued presentation of viral sequences as MHC-peptide complexes.

PATHOLOGY OF ARENAVIRUS INFECTIONS: GENERAL FEATURES

The mechanisms by which arenaviruses cause disease in humans are not fully understood. There is no

evidence that either immunopathological or allergic processes play any part in causing disease; it appears to be more likely that disease is caused by direct damage of cells by the virus. Postmortem studies on patients who died from Junin virus infection have shown generalized lymphadenopathy, endothelial swelling in the capillaries and arterioles of almost every organ, and depletion of lymphocytes in the spleen. The virus first replicates in lymphoid tissue, whence it invades the reticuloendothelial system and those cells concerned in the humoral and cellular immune responses; the host's defence mechanisms are thus impaired. Fatal illness is invariably associated with capillary damage leading to capillary fragility, haemorrhages (Figure 19.3) and irreversible shock (Johnson *et al.*, 1973). Disseminated intravascular coagulation is not a typical feature. Although Lassa fever is often regarded as being hepatotropic, the extent of hepatic damage is insufficient to account for the severity of the clinical disease, and serum transaminase values often remain within normal limits except in severe cases. Studies of Lassa virus-infected rhesus monkeys have shown that changes in vascular function may play a much greater role in pathogenesis, as a result either of viral replication in the vascular epithelium or secondary effects of virus activity in different organs. Platelet and epithelial cell functions fail immediately before death and are accompanied by a drop in the level of prostacyclin; these functions rapidly return to normal in animals surviving infection (Fisher-Hoch *et al.*, 1987). Impairment of the functions of vascular epithelium in the absence of histological changes appears to be a common feature of the final stages of viral haemorrhagic diseases in general and suggests that hypovolaemic shock may be amenable to treatment with prostacyclin.

The pathogenesis of Argentinian haemorrhagic fever has been studied in guinea-pigs infected with *Junin virus*, this being a suitable model of human disease. There is a pronounced thrombocytopenia and leucopenia characteristic of human infections, and animals die of severe haemorrhagic lesions. Bone marrow cells are destroyed, with release of proteases and acid and alkaline phosphatases into the blood; this leads to consumption of the C4 component of complement. These effects may lead in turn to progressive alterations in vascular permeability and platelet function (Rimoldi and de Bracco, 1980). The most extensive histopathologi-



Figure 19.3 Bleeding from the gum margin in a case of Argentinian haemorrhagic fever. (From Howard, 1986)

cal studies have been made on tissues from patients with Lassa fever (Walker and Murphy, 1987). However, there are many similarities in the pathological lesions found in humans following Junin and Machupo virus infections. Focal non-zonal necrosis in the liver has been described in all three conditions, with hyperplasia of Kupffer cells, erythrophagocytosis and acidophilic necrosis of hepatocytes. Councilman-like bodies can be observed together with cytoplasmic vacuulations and nuclear pyknosis or lysis. As with other organs, there is little evidence of cellular inflammation. Lesions in other organs have been described, including interstitial pneumonitis, tubular necrosis in the kidney, lymphocytic infiltration of the spleen and minimal inflammation of the central nervous system and myocardium (Walker and Murphy, 1987). The hepatic changes may be grouped into three categories: (1) mild to moderate infection with evidence of focal necrosis in less than 20% of hepatocytes; (2) hepatic regeneration but extensive damage probably centred on other organs; and (3) severe damage with multifocal necrosis involving up to 50% of hepatocytes. These changes are consistent with a direct cytolytic action of the virus; nevertheless, the simultaneous presence of Lassa virus and specific antibodies during the later stages of the acute disease suggests that antibody-dependent cellular immune reactions may also occur. Microscopic changes in the kidneys are minimal, although it is not clear whether the functional impairment is due to the deposition of antigen-antibody complexes.

Lymphocytic Choriomeningitis

Clinical and Pathological Features

Infection is often inapparent but may present as an influenza-like febrile illness, as aseptic meningitis or as severe meningoencephalomyelitis. The great majority of LCM infections are, however, benign. The incubation period is 6–13 days. In the influenza-like illness there is fever, malaise, muscular pains and bronchitis. An early leucopenia followed by lymphocytosis is a constant finding. Generally, the mean value of mononuclear cells is approximately 600 cells per mm^3 , although counts of up to 3000 per mm^3 have been recorded. A coryza, together with retro-orbital pain, anorexia and nausea, is common. During the acute phase a large number of mononuclear cells are present in the cerebrospinal fluid as part of a pleocytosis, although the absolute number varies with time after the onset of disease. As with all central nervous system disease, the cerebrospinal fluid is at increased pressure, with a slight rise in protein concentration, normal or slightly reduced sugar concentration, and a moderate number of cells, mainly lymphocytes (150–400 per mm^3). It has been noted that the majority of such patients have a history of influenza-like illness immediately prior to the onset of meningitis. The meningeal form is more common; the same symptoms may remain mild and be of short duration and patients recover within a few days, but there can be a more pronounced illness with severe prostration lasting 2 weeks or more. Chronic sequelae, including parotitis and orchitis, have been reported on occasion. Other symptoms include continuing headache, paralysis and personality changes. The few deaths reported have followed severe meningoencephalomyelitis. In this most severe form, patients may rapidly develop a bilateral papilloedema, confusion and paralysis of the extremities over a 1 week period. An erythematous rash followed by haemorrhage and death has also been reported. Virus can be isolated from blood, cerebrospinal fluid and, in fatal cases, from brain tissue. However, the preferred method of diagnosis is antibody detection by IF, although the test is not readily available in most clinical virology laboratories. Because of the possible diagnosis of related, more hazardous arenaviruses, samples should be referred to a national reference laboratory.

Epidemiology

Humans are usually infected through contact with rodents. In the past, many infections have been acquired in laboratories, where LCM may be a contaminant in laboratory colonies of mice and hamsters. In particular, virus is shed from the urine of persistently infected animals, resulting in contamination of skin and working surfaces. Hamsters kept as pet animals have also played a role in human infection. The mechanism of transmission of the virus to humans is not fully understood but is likely to involve dust contaminated by urine, the contamination of food and drink, or via skin abrasions.

Recently a variant of LCM virus has been isolated from captive New World primates. The histopathology in infected marmosets and tamarins is remarkably similar to that seen in Lassa virus infection in humans. It is suspected that these animals acquired the virus from infected *Mus musculus* rodents (Montali *et al.*, 1995).

Diagnosis of Bolivian and Argentinian Haemorrhagic fevers

Although the clinical features of Bolivian and Argentinian haemorrhagic fevers are similar, the laboratory diagnosis is approached in a somewhat different manner for these viruses. In the case of Junin, virus can be recovered consistently from the blood from the 3rd to the 8th day of illness; in contrast, direct recovery of *Machupo virus* from acutely ill patients is much more difficult. In both instances, serological methods are more useful.

CF antibodies may be detected sufficiently early in both cases, providing suitable paired sera are available. Although this technique has now largely been superseded by the use of more sensitive IF methods, the appearance of CF antibodies may still provide useful information as to the course of the infection and signal the onset of convalescence. Early use of IF techniques for the diagnosis of Argentinian haemorrhagic fever showed that specific antibodies could be detected by the indirect method approximately 30 days after onset of symptoms. Specific staining is generally seen as a bright, granular fluorescence evenly distributed over the cytoplasm of the fixed infected cell substrate. The titre of immunofluorescent antibodies increases from the

12th to the 20th day of illness and is a mixture of IgG and IgM antibodies.

Neutralizing antibodies to both *Machupo* and *Junin viruses* persist for many years at high titre, appearing simultaneously with CF antibodies. The sensitivity and specificity of neutralization tests for detecting immunity to *Junin virus* has proven to be of value in the detection retrospectively of subclinically infected individuals. The test may be carried out in Vero cell monolayers using the varying virus dilution-constant serum method. Antibody titres are then expressed as an index calculated by subtracting the logarithmic differences between the virus titre in control and experimental reactions. Inapparent infections have been shown in approximately 20% of laboratory workers handling known or presumptively positive specimens by this method.

Argentinian Haemorrhagic Fever (*Junin Virus*)

Clinical and Pathological Features

Argentinian haemorrhagic fever has been known since 1943 and *Junin virus*, the causative agent, was first isolated in 1958. The virus causes annual outbreaks of severe illness, with between 100 and 3500 cases, in an area of intensive agriculture known as the wet pampas in Argentina (Figure 19.4). Mortality in some outbreaks has ranged from 10 to 20%, although the overall mortality is generally 3–15%. After an incubation period of 7–16 days, the onset of illness is insidious, with chills, headache, malaise, myalgia, retro-orbital pain and nausea; these are followed by fever, conjunctival injection and suffusion, a pharyngeal enanthema and erythema and oedema of the face, neck and upper thorax. A few petechiae may be seen, mostly in the axilla. There is hypervascularity and occasional ulceration of the soft palate. Generalized lymphadenopathy is common. Tongue tremor is an early sign, and some patients present with pneumonitis. In the more severe cases the patient's condition becomes appreciably worse after a few days, with the development of hypotension, oliguria, haemorrhages from the nose and gums, haematemeses, haematuria and melaena. Oliguria may progress to anuria and pronounced neurological manifestations may develop. Laboratory findings have included leucopenia with a de-

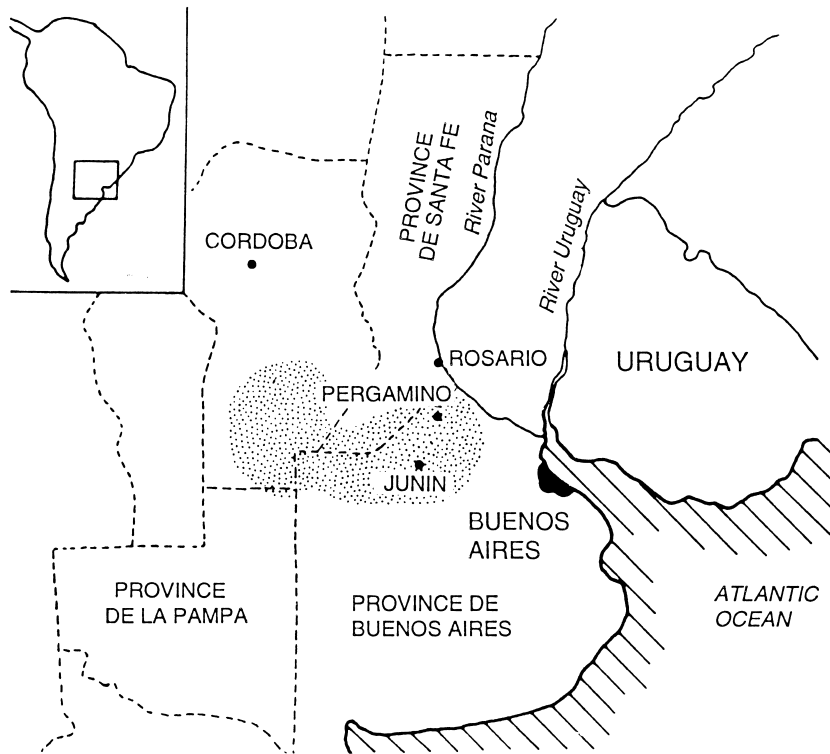

Figure 19.4 Approximate endemic zone of Argentinian haemorrhagic fever. (From Howard, 1986)

crease in the number of CD4+ cells, thrombocytopenia and urinary casts containing viral antigen. Patients recover when the fever falls, followed by diuresis and rapid improvement. Death may result from hypovolaemic shock. Subclinical infections also occur. Human-to-human transmission has not been observed.

Epidemiology

Argentinian haemorrhagic fever has a marked seasonal incidence, coinciding with the maize harvest between April and July, when rodent populations reach their peak. Agricultural workers, particularly those harvesting maize, are, not surprisingly, the most commonly affected. The main reservoir hosts of *Junin virus* are *Calomys* field voles that live and breed in burrows under the maize fields and in the surrounding grass banks (Figure 19.5). Other rodent species may also be infected. *Calomys* spp. have a persistent viraemia and viruria, and virus is also present in considerable quantities in the saliva. The mode of transmission of *Junin virus* to humans

has not been conclusively established. The virus may be carried in the air from dust contaminated by rodent excreta or may enter by ingestion of contaminated foodstuffs.

Therapy

In contrast to Lassa fever, antibodies play a major role in recovery from *Junin* infection. Controlled trials of immune plasma collected from patients at least 6 months into convalescence have shown a dramatic reduction in mortality if plasma is given within the first 8 days of illness (Maiztegui *et al.*, 1979). The efficacy of this therapy is directly related to the titre of neutralizing antibody in the plasma; as a result a dose of no less than 3000 'therapeutic units' per kg body weight has been recommended (Enria *et al.*, 1984). The late development of a neurological syndrome is seen in up to 10% of patients treated with immune plasma; it is often benign and self-limiting but points to the possible persistence of viral antigens on cells of the central nervous system well into convalescence. Treatment with immune



Figure 19.5 The habitat for the rodent *Calomys* sp. in the wet pampas of Argentina. (From Howard, 1986)

plasma also restores the response of peripheral blood lymphocytes to antigenic stimuli, suggesting that administration of plasma also results in the modulation of cellular immunity.

Prophylaxis

There have been attempts to produce a vaccine against Argentinian haemorrhagic fever. The XJCl₃ strain of virus grown in the brains of suckling mice is relatively non-pathogenic and was administered to 636 volunteers between 1968 and 1970. Over a period of 3 years, 70 cases of Junin virus infection occurred among the population but there were no cases amongst those immunized. However, the vaccine often induced a mild febrile reaction or a subclinical infection, and its use was discontinued despite the fact that over 90% of vaccinees maintained neutralizing antibody for up to 9 years. There have been renewed attempts during recent years to develop a new vaccine strain sufficiently attenuated for human use and meeting modern day requirements as to derivation, manufacture and potency. Several clones have been prepared from the original XJ isolate, one of which exhibits less neurovirulence than the XJCl₃ strain yet protected rhesus monkeys against challenge with wild type *Junin virus* (McKee *et al.*, 1993). This 'Candidate 1' vaccine has been tested in a double blind study in volunteers.

Bolivian Haemorrhagic Fever (*Machupo Virus*)

Clinical Features

Bolivian haemorrhagic fever was first recognized in 1959 in the Beni region in northeastern Bolivia. The disease continued in that region more or less annually for a number of years in the form of sharply localized epidemics. Its incidence has decreased considerably since the late 1970s and human infections are now rarely reported. The mortality in individual outbreaks varied from 5 to 30%. The most notable outbreak affected 700 people in the San Joaquin township between late 1962 and the middle of 1964. The mortality was 18%. It is worth noting that the discovery of a common morphology and serological cross-reaction between Machupo and LCM virus led to the concept of the arenavirus family.

The clinical disease is similar to Argentinian haemorrhagic fever. The incubation period ranges from 7 to 14 days and the onset is insidious. About one-third of patients show a tendency to bleed, with petechiae on the trunk and palate, and bleeding from the gastrointestinal tract, nose, gums and uterus. Almost half the patients develop a fine tremor of the tongue and hands, and some may have more pronounced neurological systems. The acute disease may last 2–3 weeks and convalescence may be protracted, generalized weakness being the most common complaint. Clinically inapparent infections are rare. *Machupo virus*, the responsible agent, is readily isolated from lymph nodes and spleen taken at necropsy. Isolation of the virus from acutely ill patients has, however, proved difficult, the best results being obtained from specimens taken 7–12 days after the onset of illness.

Epidemiology

The rodent reservoir of *Machupo virus* is the field vole *Calomys callosus*; over 60% of animals caught during the San Joaquin epidemic were found to be infected. The distribution of cases in the township was associated with certain houses and *Calomys callosus* was trapped in all households where cases occurred. Transmission to humans is probably by contamination of food and water or by infection through skin abrasions. During the years when Bolivian haemorrhagic fever was relatively

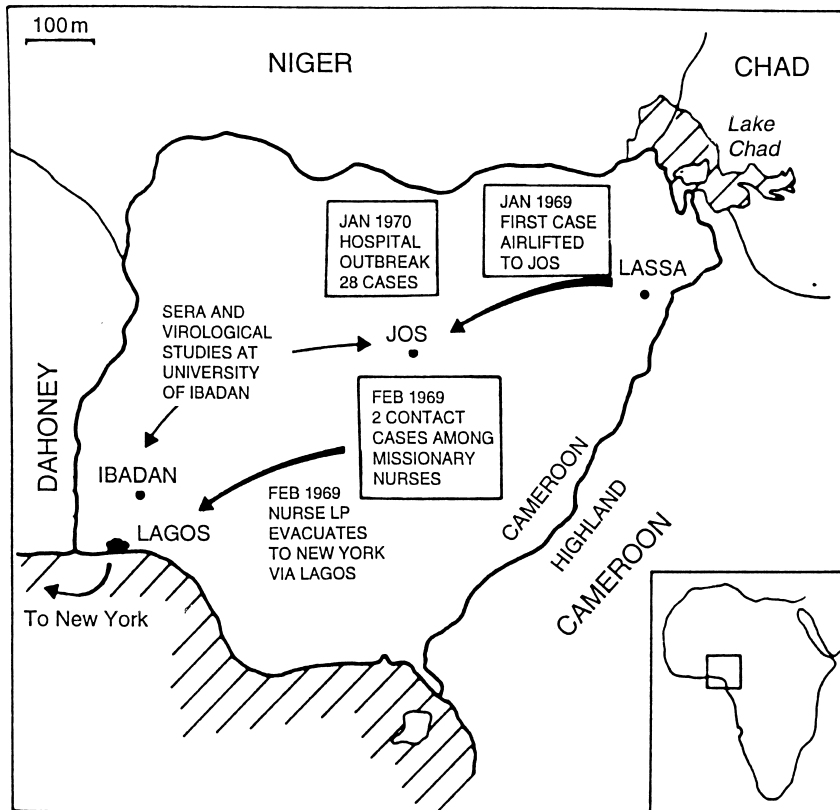

Figure 19.6 Map of Nigeria showing the localities of the 1969 and 1970 outbreaks of Lassa fever. (From Howard, 1986)

common, abnormally low rainfall, combined with an increase in the use of insecticide, led to a rapid decline in the numbers of cats, with the result that the population of Machupo virus-infected rodents increased dramatically, thus increasing the opportunity for human contact with contaminated soil and foodstuffs. The balance between cats and rodents has since been restored and this has led to a decrease in the number of reported cases over the past two decades.

Transmission from human to human is unusual but a small episode took place in 1971, well outside the endemic zone. The index case, infected in Beni, carried the infection to Cochabamba and, by direct transmission, caused five secondary cases, of which four were fatal.

Lassa Fever

History

Lassa fever made a dramatic appearance in Nigeria in 1969 as a lethal, highly transmissible disease. The first victim was an American nurse who was infected in a small mission station in the Lassa township in northeastern Nigeria, whence the virus and the disease derive their name (Figure 19.6). The origin of the infection was never determined, although it is thought to have been acquired through direct contact with an infected patient in Lassa. When the nurse's condition steadily deteriorated she was flown to the Evangel Hospital in Jos, where she died the following day. While she was in hospital she was cared for by two other American nurses, one of whom also became infected by direct contact, probably through skin abrasion. This nurse became un-

well after an 8 day incubation period and died after an illness lasting 11 days. The head nurse of the hospital, who has assisted at the postmortem examination of the first patient, fell ill 7 days after the death of the second patient, for whom she had cared and from whom she probably acquired the infection. This third case was evacuated to the USA by air in the first-class cabin of a commercial airliner with two attendants and screened from economy class passengers only by a curtain. After a severe illness under intensive care she slowly recovered. A virus, subsequently named Lassa, was isolated from her blood by workers at the Yale Arbovirus Unit. One of these virologists became ill but improved after an immune plasma transfusion donated by the third case. Five months after this infection, a laboratory technician in the Yale laboratories, who had not been working with *Lassa virus*, fell ill and died. The manner in which this infection was acquired has never been determined. This trail of events not unnaturally earned for *Lassa virus* a formidable notoriety, which was sharply enhanced by two more devastating hospital outbreaks—one in Nigeria, the other in Liberia.

The fourth outbreak was seen in Sierra Leone in October 1972. In sharp contrast to the previous outbreaks, this one was not confined to hospitals, although hospital staff were at considerable risk and several became infected. Most of the patients acquired their illness in the community and there were several intrafamilial transmissions. This led to a revision of the initial view—formed from experience of nosocomial infections—that Lassa fever has a high mortality.

Lassa fever has since continued to occur in west Africa, usually as sporadic cases (Monath, 1987). Between 1969 and 1978 there were 17 reported outbreaks affecting 386 patients, in whom the mortality was 27%. Eleven of the episodes were in hospitals, where the case fatality rate reached 44%; two were laboratory infections, two were community-acquired outbreaks, and two were prolonged community outbreaks. Eight patients were flown to Europe or North America. One of them was evacuated with full isolation precautions and the remainder, of whom five were infectious, travelled on scheduled commercial flights as fare-paying passengers. Fortunately, no contact cases resulted.

Clinical Features

Lassa virus causes a spectrum of disease ranging from subclinical to fulminating fatal infection. Recent studies in Sierra Leone show that most patients present with only a mild form of the disease that can be resolved by good primary healthcare. The incubation period ranges from 3 to 16 days and the illness usually begins insidiously. The disease is difficult to distinguish in the early stages from other systemic febrile illnesses, the most reliable clinical signs being a sore throat, myalgia, abdominal and lower back pains, accompanied by vomiting. In most cases the disease resolves. However, in a significant number of cases the symptoms suddenly worsen after the first week, with continuing high fever, severe prostration, chest and abdominal pains, conjunctival injection, diarrhoea, dysphagia and vomiting. Chest pain, located substernally and along the costal margins, is often associated with tenderness on pressure and is exacerbated by coughing and deep inspiration. One important physical finding is a distinct pharyngitis; yellow-white exudative spots may be seen on the tonsillar pillars, together with small vesicles and ulcers. The patient appears toxic, lethargic and dehydrated; the blood pressure is low and there is sometimes a bradycardia relative to the body temperature. There may be cervical lymphadenopathy, coated tongue, puffiness of the face and neck, and blurred vision. Occasionally a faint maculopapular rash may be seen during the 2nd week of illness on the face, neck, trunk and arms. In severe cases, haemorrhages also occur. Cough is a common symptom, and light-headedness, vertigo and tinnitus appear in a few patients. Deafness has also been noted in about 20% of patients and, although it may be reversible, is more often permanent. In approximately 25% of cases there is marked involvement of the central nervous system, manifested by disorientation, ataxia and seizures. Progression to severe haemorrhaging occurs in around a fifth of patients and it is in such patients that mortality exceeds 50%.

The fever generally lasts 7–17 days and is variable. Convalescence begins in the 2nd to 4th weeks, when the temperature returns to normal and the symptoms improve. Most patients complain of extreme fatigue for several weeks. Loss of hair and deafness are often observed, and there may be brief bouts of fever. Patients in whom the disease is fatal

not uncommonly have a high sustained fever. Acutely ill patients suddenly deteriorate between days 7 and 14, with a sudden drop in blood pressure, peripheral vasoconstriction, hypovolaemia and anuria; there may be pleural effusions and ascites. In addition, coma, stupor, tremors and myoclonic twitching may occur. Death is due to shock, anoxia, respiratory insufficiency and cardiac arrest.

Epidemiology

Lassa virus has been repeatedly isolated from the multimammate rat *Mastomys natalensis* in Sierra Leone and Nigeria. This rodent is a common domestic and peridomestic species, and large populations are widely distributed in Africa south of the Sahara. During the rainy season it may desert the open fields and seek shelter indoors. Some genetic variation has been shown in *Mastomys* populations inhabiting different ecological niches; however, there appears to be no difference in the prevalence of antibody and virus in at least two of the karyotypes found in west Africa. The animals are infected at birth or during the perinatal period. Like other arenaviruses, *Lassa virus* produces a persistent, tolerant infection in its rodent reservoir host with no ill effects and without any detectable immune response. The animals remain infectious during their lifetime, freely excreting the virus in urine and other body fluids. The correlation between the prevalence of antibody in a community and the degree of infestation by infected rodents, however, is poor.

Studies of the ratio of clinical illness to infections have recently confirmed that Lassa fever is endemic in several regions of west Africa. It has been estimated that only 1–2% of infections are fatal—substantially less than the figures of 30–50% originally associated with the early nosocomial outbreaks. However, there may still be up to 300 000 infections per year, with as many as 5000 deaths (McCormick *et al.*, 1986). The seroconversion rates among villagers in Sierra Leone vary from 4 to 22 per 100 susceptible individuals per year; up to 14% of febrile illness in such population groups is due to Lassa virus infection. There is a marked variation as to the severity of the disease according to different geographical regions. This may in part be due to genotypic variation of *Lassa virus*, or dose and route of infection, or a combination of these factors (Fisher-Hoch, 1993). There is a relatively high rate of asymptomatic and mild infection in endemic

areas. One reason for this may be the frequency of reinfections; although about 6% of the population lose antibody annually, rises in antibody titre are also often observed. It is not clear if reinfection results in clinical disease. A frequent finding of incomplete immunity after infection would have profound implications for the use of a vaccine.

There may be secondary spread from person to person in conditions of overcrowded housing and particularly in rural hospitals. There is a particularly high risk to staff and patients on maternity wards, as Lassa fever is a major cause of spontaneous abortion. Medical attendants or relatives who provide direct personal care are most likely to contract the infection; as noted above, accidental inoculation with a sharp instrument and contact with blood have caused infection in a few cases. Airborne spread may take place, as well as mechanical transmission. Although in Sierra Leone there has been no evidence of airborne spread in hospital outbreaks, one of the 1970 outbreaks in Nigeria is believed to have been caused by airborne transmission from a woman with severe pulmonary infection.

Lassa fever is a major cause of spontaneous abortion in West Africa. The virus is readily recovered from the blood and placenta of aborted fetuses. Women generally recover quickly after such abortions, showing a dramatic decline in viraemia, partially due to massive bleeding at the time of abortion (A. Demby, personal communication). Paediatric Lassa fever is known to occur more commonly in male children, for unknown reasons. Presenting as an acute febrile illness, the case fatality rate may approach 30% in children, with widespread oedema, abdominal distension and bleeding.

Diagnosis

The diagnosis of Lassa fever is confirmed by isolation of the virus or demonstration of a specific serological response. Infection in the early stages can be confused clinically with a number of other infectious diseases, particularly malignant malaria (Table 19.2) (Woodruff, 1978).

Lassa virus grows readily in Vero cell culture and virus can usually be isolated within 4 days. Virus can be cultured from serum, throat washings, pleural fluid and urine; it is excreted from the pharynx for up to 14 days after the onset of illness and in urine for up to 67 days after onset. Lassa infection can be

Table 19.2 Differential diagnosis of arenavirus fevers

Yellow fever
Malaria
Bacterial septicaemia
Enteric fevers (typhoid, paratyphoid)
Streptococcal pharyngitis
Typhus
Trypanosomiasis
Leptospirosis
Other viral haemorrhagic fevers

diagnosed early by detection of virus-specific antigens in conjunctival cells using indirect IF. The use of the reverse transcriptase–polymerase chain reaction (RT-PCR) method is possible, although these techniques are of limited practical use in endemic areas. It is important to note that virus isolation should be attempted only in laboratories equipped (level P4) to provide maximum containment to protect the investigator. Suspected cases should be reported immediately to local and national public health authorities.

The most sensitive serological test for the detection of Lassa antibodies is indirect IF; antibodies can be detected by this method in the second week of illness. Complement-fixing antibodies develop more slowly and are rarely detectable before the third week after onset. On occasion, complement-fixing antibodies failed to develop in patients from whom *Lassa virus* has been isolated. Neutralizing antibodies are difficult to measure *in vitro*, in sharp contrast to infections by the South American arenaviruses, for reasons that are unclear.

The two most reliable prognostic markers of fatal infections are the titres of circulating virus and of aspartate aminotransferase (AST). Patients in whom the titre of virus exceeds 10^4 TCID₅₀ ml⁻¹ and with AST levels above 150 iu have a poor prognosis, and fatality rates approach 80%. In contrast, patients with virus and enzyme levels below these values have a greater than 85% chance of survival (Johnson *et al.*, 1987). This demonstration of an association between the degree of viraemia and mortality is unique for virus infections and contrasts with the difficulty in predicting the outcome in patients with Argentinian and Bolivian haemorrhagic fevers. Although Lassa fever can be diagnosed accurately from the presence of IgM antibodies on admission, there is no correlation between the time of appearance, the titre of specific antibodies and clinical outcome. Lassa fever is particularly

severe in pregnant women. A study of 75 women in Sierra Leone showed that 11 of 14 deaths were the result of infection during the third trimester; a further 23 patients suffered abortion in the first and second trimesters.

Therapy

Although the passive administration of Lassa immune plasma may suppress viraemia and favourably alter the clinical outcome, it does not always do so, particularly if the patient has a high virus burden (McCormick *et al.*, 1986). Failure may be due to the difficulty in assessing accurately the titre of viral neutralizing antibodies in the plasma, the late and non-uniform nature of this response in convalescence, and antigenic variation. The widespread occurrence of human immunodeficiency virus (HIV) infections in West Africa precludes at present the use of immune plasma from convalescent individuals in this region. This is in marked contrast to the benefit of immune plasma in the treatment of Junin infections (Maiztegui *et al.*, 1979; Enria *et al.*, 1986). This may be due either to the high titre of neutralizing antibodies that develops soon after the acute phase or to the lesser importance of antibody in the resolution of Lassa fever.

Greater success has been achieved with antivirals. In one study of patients with a poor prognosis, treatment for 10 days with intravenous ribavirin (60–70 mg kg⁻¹ per day) within 6 days after the onset of fever showed a case fatality rate of 5% (McCormick *et al.*, 1986). In contrast, patients treated 7 or more days after the onset of fever had a case fatality rate of 26%. In the Sierra Leone study, viraemia of greater than $10^{3.6}$ TCID₅₀ ml⁻¹ on admission was associated with a case fatality rate of 76%. Patients with this risk factor who were treated with intravenous ribavirin within 6 days of the onset of fever had a case fatality rate of 9%, compared with 47% in those treated 7 days or more after the onset of illness. Oral ribavirin is less effective.

The introduction of vaccines against *Junin virus* has stimulated the expectation that a vaccine could also be developed for the prevention of Lassa virus infections. However, the perceived necessity for a strong cell-mediated response would dictate the development of an attenuated vaccine; this raises concerns, however, as to a possible reversion to virulence of any attenuated Lassa virus vaccine. Given these technological difficulties and the limited

numbers globally at risk of infection, it is unlikely that such a vaccine will be developed in the near future.

prevalence rates of up to 3% have been found among healthy individuals, and up to 10% of household contacts have anti-Guanarito virus antibodies.

EMERGING ARENAVIRUS INFECTIONS

Brazilian Haemorrhagic Fever (*Sabia Virus*)

This arenavirus was isolated in 1990 from human cases at autopsy (Lisieux *et al.*, 1994). The source of the infection was uncertain but is likely to have been acquired by exposure to infected rodents in an agricultural setting in an area immediately outside São Paulo. As a continuing reminder of the potential severity of these infections, a laboratory worker was critically ill after having been accidentally exposed to an aerosol containing *Sabia virus*. The virus was first isolated from a fatal case of haemorrhagic fever. A laboratory-acquired infection was characterized by a febrile illness accompanied by leucopenia and thrombocytopenia. There is little information regarding the epidemiology of this virus, although the extensive liver necrosis seen in the first case is a warning that this and other haemorrhagic fevers may on first examination be mistaken for yellow fever.

Venezuela Haemorrhagic Fever (*Guanarito Virus*)

Between May 1990 and March 1991 an outbreak occurred among residents of Guanarito municipality on the central plains of Venezuela. Originally mistaken as dengue fever, a total of 104 cases were recorded with a mortality rate of around 25%. The *Guanarito virus* was subsequently isolated from the spleens of such cases at autopsy. The principal rodent hosts of this virus have been identified (Table 19.1) (Tesh *et al.*, 1993, 1994).

The disease has a clinical profile similar to that of Argentinian haemorrhagic fever, with patients manifesting a thrombocytopenia, haemorrhaging and neurological signs. Pharyngitis has been observed and deafness reported in patients convalescent from the disease. Although initial reports suggest a high mortality for this infection, antibody

Oliveros Virus

This new agent has been isolated from a small rodent *Bolomys obscurus*, within the endemic region of Argentinian haemorrhagic fever (Bowen *et al.*, 1996). With a rodent host distinct from that of *Junin virus*, approximately 25% of captured *Bolomys obscurus* have been found to contain antibodies to this virus. At present, there are no indications that this virus causes significant numbers of human infections (Mills *et al.*, 1996).

SUMMARY

The increasing numbers of human infections due to arenaviruses is beginning to require a greater vigilance on the part of public health workers. An arenavirus aetiology for febrile illnesses in individuals residing in endemic areas should be considered, particularly those who are likely to have come into regular contact with rodents by virtue of their lifestyle or occupation.

Although there is little or no evidence for human arenavirus infection in North America, Europe and Asia, this situation may change once there is greater awareness of the potential for emerging infections, particularly in geographical areas where the last decades have seen clearance of woodland, forest and scrub in advance of extensive changes in agricultural practices. The only certainty is that the number of arenaviruses identified hitherto will increase as more becomes known regarding the natural history of these agents.

REFERENCES

- Bowen, M.D., Peters, C.J., Mills, J.N. *et al.* (1996) Oliveros virus: a novel arenavirus from Argentina. *Virology*, **217**, 362–366.
- Buchmeier, M.J., Lewick, H.A., Tomori, O. *et al.* (1981) Monoclonal antibodies to lymphocytic choriomeningitis virus and Pichinde viruses: generation, characterisation and cross-reactivity with other arenaviruses. *Virology*, **113**, 73–85.
- Casals, J. (1975) Arenaviruses. *Yale Journal of Biology and Medi-*

- cine, **48**, 115–140.
- Casals, J., Buckley, S.M. and Cedenoe, R. (1975) Antigenic properties of the arenaviruses. *Bulletin of the World Health Organization*, **52**, 421–427.
- Clegg, J.C.S. and Lloyd, G. (1984) The African arenaviruses Lassa and Mopeia: biological and immunochemical comparisons. In *Segmented Negative Strand Viruses* (eds R.W. Compans and D.H.L. Bishop), pp 341–347. Academic Press, Orlando.
- Enria, D.A., Briggiler, A.M., Fernandez, N.J. *et al.* (1984) Importance of dose of neutralising antibodies in treatment of Argentine haemorrhagic fever with immune plasma. *Lancet*, **ii**, 255–256.
- Enria, D.A., de Damilano, A.J. and Briggiler, A.M. (1986) Síndrome neurológico tardío en enfermos de fiebre hemorrágica Argentina tratados con plasma inmune. *Medicina (Buenos Aires)*, **45**, 615–617.
- Fisher-Hoch, S.P. (1993) Arenavirus pathophysiology. In *The Arenaviridae* (ed. M.S. Salvato), pp 299–323. Plenum Press, New York.
- Fisher-Hoch, S.P., Mitchell, S.W., Sasso, D.R. *et al.* (1987) Physiological and immunologic disturbances associated with shock in a primate model of Lassa fever. *Journal of Infectious Diseases*, **155**, 465–474.
- Fuller-Pace, F. and Southern, P. (1989) Detection of virus-specific RNA-dependent RNA polymerase activity in extracts from cells infected with lymphocytic choriomeningitis virus: *in vitro* synthesis of full-length viral RNA species. *Journal of Virology*, **63**, 1938–1944.
- Howard, C.R. (1986) Arenaviruses. In *Perspectives in Medical Virology*, vol. 2 (ed. A.J. Zuckerman). Elsevier, Amsterdam.
- Howard, C.R. and Simpson, D.H.L. (1980) The biology of arenaviruses. *Journal of General Virology*, **51**, 1–14.
- Johnson, K.M., Webb, P.A. and Justines, G. (1973) Biology of Tacaribe-complex virus. In *Lymphocytic Choriomeningitis Virus and Other Arenaviruses* (ed. F. Lehmann-Grube), pp 241–258. Springer-Verlag, Vienna.
- Johnson, K.M., McCormick, J.B., Webb, P.A. *et al.* (1987) Lassa fever in Sierra Leone: clinical virology of Lassa fever in hospitalized patients. *Journal of Infectious Diseases*, **155**, 456–463.
- Klenerman, P., Hengartner, H. and Zinkernagel, R.M. (1997) A non-retroviral RNA virus persists in DNA form. *Nature*, **390**, 298–301.
- Lehmann-Grube, F. (1971) Lymphocytic choriomeningitis virus. *Virology Monographs*, **10**, 1.
- Levis, S.C. and Saavedra, M.C. (1984) Endogenous interferon in Argentine haemorrhagic fever. *Journal of Infectious Diseases*, **149**, 428–433.
- Lisieux, T., Coimbra, M., Nassar, E.S. *et al.* (1994) New arenavirus isolated in Brazil. *Lancet*, **381**, 391–392.
- McCormick, J.B., King, I.J. and Webb, P.A. (1986) Lassa fever: effective therapy with ribavirin. *New England Journal of Medicine*, **314**, 20–26.
- McKee, K.T.J., Barrera Oro, J.G., Kuehne, A.I. *et al.* (1993) Safety and immunogenicity of a live attenuated Junin (Argentine hemorrhagic fever) vaccine in rhesus macaques. *American Journal of Tropical Medicine and Hygiene*, **48**, 403–411.
- Maiztegui, J.I., Fernandez, J.M. and de Damilano, A.J. (1979) Efficacy of immune plasma in treatment of Argentine haemorrhagic fever and association between infection and a late neurological syndrome. *Lancet*, **ii**, 1216–1217.
- Mills, J.N., Barrera Oro, J.G., Bressler, D.S. *et al.* (1996) Characterization of Oliveros virus, a new member of the Tacaribe complex (*Arenaviridae*, arenavirus). *American Journal of Tropical Medicine and Hygiene*, **54**, 399–404.
- Monath, T.P. (1987) Lassa fever: new issues raised by field studies in West Africa. *Journal of Infectious Diseases*, **155**, 433–436.
- Montali, R.J., Connolly, B.M., Armstrong, D.L. *et al.* (1995) Pathology and immunohistochemistry of callitrichid hepatitis, and emerging disease of captive New World primates caused by lymphocytic choriomeningitis virus. *American Journal of Pathology*, **147**, 1441–1449.
- Murphy, F.A. and Whitfield, S.G. (1975) Morphology and morphogenesis of arenaviruses. *Bulletin of the World Health Organization*, **52**, 409–419.
- Peters, C.J., Buchmeier, M.J., Rollin, P.E. *et al.* (1996) Arenaviruses. In *Field's Virology*, 3rd edn (eds B.N. Fields, D.M. Knipe, P.M. Howley *et al.*), pp 1521–1551. Lippincott-Raven, Philadelphia.
- Pfau, C.J. (1974) Biochemical and biophysical properties of the arenaviruses. *Progress in Medical Virology*, **18**, 64–80.
- Rimoldi, M.T. and de Bracco, M.M. (1980) *In vitro* inactivation of complement by a serum factor present in Junin virus-infected guinea pigs. *Immunology*, **39**, 159–164.
- Rowe, W.P. (1954) Studies on pathogenesis and immunity in lymphocytic choriomeningitis virus of the mouse. US Naval Medical Research Institute. Report NM 005.048.14.01. Department of Defense, Washington DC.
- Salas, R., Manzione, W., de Tesh, R.B. *et al.* (1991) Venezuelan haemorrhagic fever. *Lancet*, **338**, 1033–1036.
- Salvato, M.S. (1993) *The Arenaviridae*. Plenum Press, New York.
- Southern, P.J. (1996) *Arenaviridae: the viruses and their replication*. In *Fields Virology* (eds B.N. Fields, D.M. Knipe, P.M. Howley *et al.*) pp 1505–1519. Lippincott-Raven, Philadelphia.
- Tesh, R.B., Wilson, M.L., Salas, R. *et al.* (1993) Field studies of the epidemiology of Venezuelan hemorrhagic fever: implication of the cotton rat *Sigmodon alstoni* as the probable rodent reservoir. *American Journal of Tropical Medicine and Hygiene*, **49**, 227–235.
- Tesh, R.B., Jahrling, P.B., Salas, R. *et al.* (1994) Description of Guanarito virus (*Arenaviridae*, arenavirus), the aetiological agent of Venezuelan hemorrhagic fever. *American Journal of Tropical Medicine and Hygiene*, **50**, 452–459.
- Walker, D.H. and Murphy, F.A. (1987) Pathology and pathogenesis of arenavirus infections. *Current Topics in Microbiology and Immunology*, **133**, 89–113.
- Whitton, J.L., Gebhard, J.R., Lewicki, H. *et al.* (1988) Molecular definition of a major cytotoxic T-lymphocyte epitope in the glycoprotein of lymphocytic choriomeningitis virus. *Journal of Virology*, **62**, 687–695.
- Woodruff, A.W. (1978) In *Modern Topics in Infection* (ed. J.D. Willams), 240. Heinemann Medical, London.
- Young, P.R. (1987) *Arenaviridae*. In *Animal Virus Structures* (eds M.V. Nermut and A.C. Steven), pp 185–198. Elsevier, Amsterdam.
- Zinkernagel, R.M. and Doherty, P.C. (1979) MHC-restricted cytotoxic T-cells: studies on the biological role of polymorphic major transplantation antigens determining T-cell restriction-specificity, function and responsiveness. *Advances in Immunology*, **27**, 151–177.

Filoviruses

Colin R. Howard

Royal Veterinary College, London, UK

INTRODUCTION

There have been few pathogens that have invited as much media attention and scientific speculation as *Ebola* and *Marburg viruses*. Once thought to be rare outbreaks of severe human disease, events over the past 10 years have shown clearly that these agents are of potential public health importance worldwide. Although considered as zoonoses, it is not known with certainty which species act as natural reservoirs of these viruses, nor indeed whether or not there is an intermediate host. Much of our knowledge stems from epidemiological studies into human-to-human transmission, particularly in a nosocomial setting. Although the secrets of these viruses are beginning to yield to modern molecular biological techniques, the natural history of these viruses remains a mystery. What is clear, however, is that filoviruses can emerge almost anywhere without warning. Thus, clinical virologists need to be acquainted with diseases they cause and the fact that these viruses need to be excluded rapidly when undertaking the diagnosis of severe or moderate haemorrhagic disease.

PROPERTIES OF THE VIRUSES

Nomenclature and Classification

The filovirus group has at present only two members: the *Marburg* and *Ebola viruses*. Both are indigenous to Africa and cause severe haemorrhagic

disease in humans and non-human primates. Initial studies on these agents suggested a morphology similar to that of the rhabdoviruses, but both agents were later shown to possess features distinctive enough to warrant the proposal of a new virus family, the *Filoviridae*. The name refers to the long filamentous appearance of these viruses under the electron microscope (Latin: *filo* = filament or thread). Filoviruses share a similar genetic organization with the members of the families *Paramyxoviridae* and *Rhabdoviridae*. The three families have recently been grouped into a single taxonomic order, the *Mononegavirales*.

The names of filoviruses refer to the places where they were first recorded; in 1967 outbreaks of haemorrhagic fever occurred in three places in Europe, including Marburg, Germany, among handlers of tissue from imported African green monkeys. In 1976, two epidemics occurred simultaneously in southern Sudan and across the border in northern Zaire. Although these latter outbreaks are now known to have been due to viruses with somewhat different properties, both were referred to as Ebola viruses after a small river to the north of Yambuku, the village of origin of the patient in Zaire from whom the first isolate was obtained. There has since been evidence of filovirus infections in neighbouring regions and in other parts of Africa (Table 20.1). A new form of Ebola, named Reston after the locality in Virginia, USA where it was first located, has been associated with cynomolgus monkeys first caught in the Philippines. It is reasonable to assume that other filoviruses may exist in Africa and elsewhere

Table 20.1 Recorded outbreaks of filovirus infections

Virus	Year	Location	Cases	Mortality
<i>Marburg</i>	1967	West Germany	29	7 (24)
	1967	Yugoslavia	2	0
	1975	Southern Africa	3	1 (33)
	1980	Kenya	2	1 (50)
	1982	South Africa	1	0
<i>Ebola</i>	1987	Kenya	1	1
	1972	Caire	1 ^a	0
	1976	Sudan	360	150 (42)
	1976	Zaire	237	211 (89)
	1977	Zaire	2	2
	1979	Sudan	34	22 (65)
	1994	Gabon	44	29 (66)
	1995	Côte d'Ivoire	1	0
	1995	Zaire	315	244 (77)
	1995	Côte d'Ivoire	1	0
	1996	Gabon	37	21 (57)
	1996	Gabon	60	45 (75)
	<i>Ebola (Reston)</i>	1989	USA	4 ^b
1990		Philippines	12 ^b	0
1992		Italy	0 ^b	0

^aRetrospective diagnosis.

^bMonkeys.

Values in parentheses are percentages.

which may initially be mistaken from other causes of haemorrhagic fever. For general reviews of these viruses, see Gear (1988), Lloyd (1998) and Murphy and Peters (1998).

Morphology and Ultrastructure of Infected Cells

The virions of Ebola and Marburg are very similar in morphology. By electron microscopy, Marburg and Ebola particles are seen in a variety of forms; these are generally long filaments, sometimes with extensive branching, or as U-shaped, 6-shaped or circular structures (Ellis *et al.*, 1979). The particles vary greatly in length (up to 14 000 nm), but have a uniform diameter of 70 nm and an outer membrane covered with 15 nm projections spaced 10 nm apart (Figure 20.1). Although the lengths of Marburg and Ebola particles vary over a wide range, a recent study with rate-zonal, sucrose gradient-purified particles indicates that the unit length associated with peak infectivity for Marburg is 790 nm. Ebola virus is some 1.2 times longer at 970 nm.

Beneath the virion envelope lies a complex, 20 nm diameter nucleocapsid consisting of a hollow 10–

15 nm core surrounded by a helical, tubular capsid of approximately 50 nm; the latter bears cross-striations with a periodicity of about 5 nm. The latter structures within infected cells are presumed to be virion nucleocapsids because their diameters are the same as those of the tubular structures found in intracellular inclusions. These probably correspond to the nucleocapsid structures with a density of 1.32 g ml⁻¹ released from virions by detergent treatment.

Virions are constructed from preformed nucleocapsids synthesized in the cytoplasm and envelopes are added by budding through cellular membranes. Thus virus-infected cells contain prominent cytoplasmic inclusion bodies consisting of viral nucleoprotein material (Ellis *et al.*, 1978). These bodies are complex and distinct, consisting of a finely fibrillar or granular ground substance which condenses into either tubular structures or nucleocapsids. As infection proceeds, these increase in size and become highly structured, even at sites remote from the cell membranes. The budding of completed virions takes place at cell membranes, into which virion spikes have been inserted. At the time of maturation from the cell surface a series of individual nucleocapsids becomes enclosed within a single continuous envelope; each individual nucleocapsid is only about 700 nm long when produced in the infected cell. It appears that nucleocapsids, at the time of budding, may orientate relative to the cell membrane, in any plane from perpendicular to parallel, and may undergo the branching characteristic of these viruses. The final infective particle is believed to be the torus form, made by the flexing of individual core length fragments into a circle or torus.

Physicochemical Properties

The extraordinary length of filoviruses makes purification difficult; with an estimated molecular weight in excess of 500 × 10⁶, particles migrate in density gradients very slowly at a sedimentation coefficient of around 1400 S. Filoviruses have a buoyant density of 1.14 g ml⁻¹ in potassium tartrate gradients, which reflect the lipid-containing nature of the outer envelope. Lipid solvents destroy viral infectivity and release the inner nucleocapsid with a density of 1.34 g ml⁻¹. This ribonucleo-

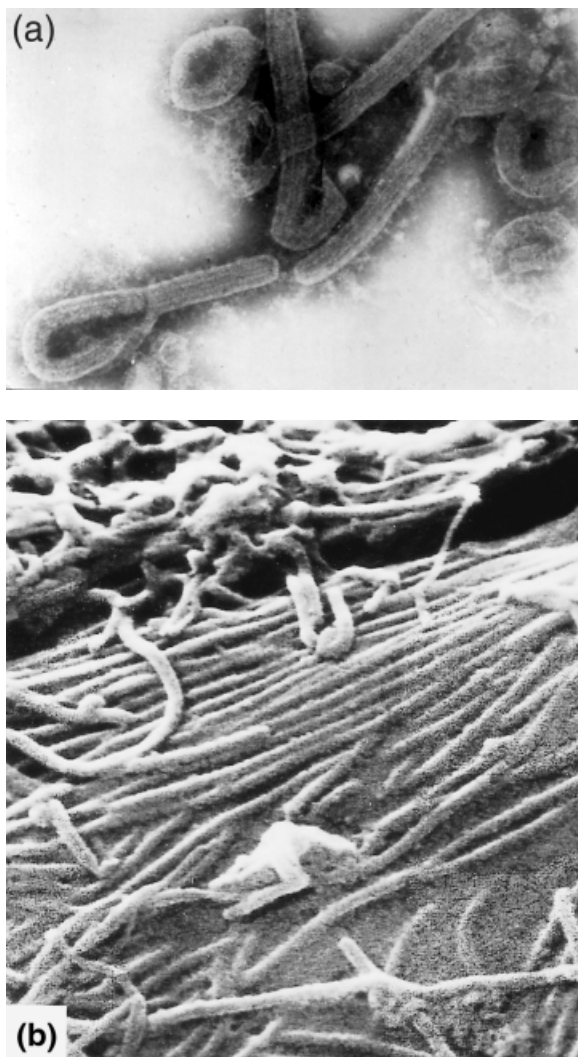

Figure 20.1 Negative-stain electron micrographs of (a) Marburg and (b) Ebola viruses. (Courtesy of Dr D.S. Ellis)

protein complex contains the genome, the major nucleocapsid structural protein (NP) and smaller quantities of other proteins which may be involved in expression and replication.

In the interest of safety in handling these viruses, a knowledge of virion susceptibility to inactivation is important. Infectivity is stable at room temperature but destroyed by heating at 60°C for 30 minutes. Heating for 60 minutes adds an extra margin of safety as there are slight differences in the inactivation rates of Ebola and Marburg viruses (Mitchell and McCormick, 1984); it still permits the assay of serum electrolytes, glucose and blood urea

Table 20.2 Filovirus gene products

Protein	Mol.wt ^a (kb)	Function
NP	78	Major nucleocapsid structural protein
VP35	31	Bound to nucleocapsid: RNA polymerase modulator
VP40	32	Matrix structural protein
GP	75 (170) ^b	Envelope glycoprotein
sGP (Ebola)	15	Secreted glycoprotein: modulates host immune response?
VP30	32	Minor nucleocapsid protein
VP24	29	Matrix or membrane-associated
L	267	RNA polymerase: transcriptional replication

^aEstimates from cloned genes of Marburg virus.

^bEstimates of glycosylated form resolved by SDS-PAGE.

in blood samples. The viruses are also inactivated by a variety of physical and chemical treatments, e.g. ultraviolet (UV) and gamma irradiation, 1% formalin and propiolactone. Dilution of blood samples into 3% acetic acid is sufficient to inactivate virus without affecting white blood cell counts (Mitchell and McCormick, 1984). Filoviruses are also inactivated by exposure to various phenolic disinfectants.

Nucleic Acid

These are the largest non-segmented negative-stranded RNA genomes discovered to date. The filoviruses contain a single molecule or RNA with a molecular weight of $c. 4.2 \times 10^6$ (19.1 kb). The genome is not infectious *per se* and does not contain significant lengths of poly(A) at its 3' end, features characteristic of those viral genomes unable to act as viral mRNA without prior RNA polymerase activity. The filoviruses are therefore considered to be negative-sense viruses with a strategy of replication and expression similar to that of the rhabdoviruses and paramyxoviruses.

Complete genome sequences are available for Marburg and Ebola viruses (accession numbers Z12132 and J04337, respectively). Both contain seven linearly-arranged genes organized in a similar manner to those of the rhabdoviruses and paramyxoviruses. The order of genes is (3')-NP-VP35-

VP40-GP-VP30-VP24-L-(5'). The function of these gene products is summarized in Table 20.2. A unique feature is the presence of short, overlapping regions between the transcription start sequences and the termination stop site of the upstream gene. There is conservation of base sequences at the 3' end of both Ebola and Marburg viruses.

Recent estimates of evolutionary divergence suggest that Marburg and Ebola viruses have a substitution rate of 3.6×10^{-5} per nucleotide per year, many hundreds of times slower than, for example, influenza A virus and retroviruses. Thus Marburg and Ebola diverged at least several thousand years ago (Suzuki and Gojobori, 1997).

Proteins

Both Ebola and Marburg viruses contain seven major polypeptides expressed monocistronically. In many respects the assignment of proteins to structural components closely resembles that of the rhabdoviruses, a finding that at first prompted attempts to classify both agents within the *Rhabdoviridae*. However, there are important differences, particularly in the sizes of the major virion polypeptides. Ebola virus consists of an internal nucleocapsid with one major polypeptide (NP) of molecular weight 78 000, the outer envelope with a single glycoprotein (GP) of molecular weight 170 000 and a further large protein (L) of molecular weight 267 000. Additionally, there are four other structural proteins, VP40, VP35, VP30 and VP24, so designated after their respective molecular weights (Elliott *et al.*, 1985). The VP40 protein is the most abundant, being a matrix protein similar to that of other enveloped, negative-strand RNA viruses. Detergent treatment of purified virions releases the viral nucleocapsid: the VP35 remains bound under low salt conditions, suggesting that this polypeptide may have a functional role similar to that of the paramyxovirus and rhabdovirus NS polypeptide.

The glycoproteins of Marburg and the three subtypes of Ebola differ markedly. Although the glycoprotein gene of Marburg is expressed as a single gene product, the Ebola genome codes for the two glycoproteins in two reading frames; the products are expressed through transcriptional editing and translational frameshifting (Feldman *et al.*,

1993). The Ebola virus structural glycoprotein (GP) forms the envelope peplomers; the second glycoprotein of molecular weight 15 000 (sGP) is made in considerable quantities and secreted in soluble form from the infected cell (Sanchez *et al.*, 1996).

Variation Among Isolates

Early evidence from biochemical analyses, serology and cross-protection studies in monkeys showed clearly the existence of at least two independent, genetically stable, strains of *Ebola virus*. Genome sequencing has shown that isolates obtained at different times, either within Sudan or Zaire, are of similar genotype but remain distinguishable from those taken from patients at the other locality. Two Zaire strains isolated a year apart were found to be genotypically identical and a similar analysis of five isolates from the Sudan over a 3 year period showed only a limited change. This finding illustrates that *Ebola virus* is genetically stable to the same degree as other members of the order *Mononegavirales*. This has been illustrated dramatically by the finding of high genetic homology between the 1976 Zaire strains with those causing the Kikwit outbreak 19 years later in eastern Zaire.

Phylogenetic analyses show a clear distinction between Marburg and Ebola viruses. However, the difference among Ebola isolates is often substantial, with sequence variability being as great as 47%. Interestingly, the monkey-associated Reston subtype shows a closer identity with the Sudan subtype than with the cluster of Ebola isolates from Zaire and Gabon (Sanchez *et al.*, 1996).

The differences between the two African Ebola virus strains from Sudan and Zaire are reflected in their antigenic properties. Sera from immune individuals contain substantially higher titres of antibodies against the homologous than against the heterologous virus; this reaction appears asymmetric, as sera from patients in Zaire react better with the Sudan virus than vice versa. Absorption of human antisera with heterologous virus enhances the specificity of these reactions; Richman *et al.* (1983) reported that absorption of antiserum to a Zaire strain with the Boniface isolate from Sudan reduced binding to the homologous antigen by over 40%, whereas binding to Boniface antigens was completely abolished. In the reverse experiment, how-

ever, binding to the Zaire virus (Mayinga strain) was reduced (by 68%) but not completely prevented.

Replication

Little is known regarding the intracellular events accompanying filovirus replication. Elliott *et al.* (1985) examined viral protein synthesis in Ebola-infected cells by means of immunoprecipitation, as host cell protein synthesis is not inhibited significantly by virus growth. Strains from the Sudan appeared to have a longer growth cycle than virus from Zaire. Both the nucleocapsid protein (NP) and the major envelope glycoprotein (GP) could be detected by 6 hours after infection. Viral mRNA was first detected at 7 hours, reached a peak by 18 hours and thereafter declined (Sanchez and Kiley, 1987). A total of six monocistronic mRNAs have been detected but so far no virion RNA has been found within infected cells.

Resolution of virus-specific polypeptides is helped by the addition of actinomycin D to reduce the level of host gene transcription. The most abundant protein, the membrane-associated protein VP40, appears at 12 hours, later than the appearance of VP35 at 8 hours, which implies a regulatory role for this minor virus component. The nucleocapsid NP and VP30 proteins are phosphorylated during the growth cycle, possibly as part of a mechanism that controls expression and replication of the genome in ribonucleoprotein complexes, but this is speculative.

Serology and Antigenic Relationships

Casals (1971), using the complement fixation (CF) test, determined that *Marburg virus* is not serologically related to a variety of arboviruses and rhabdoviruses. The use of indirect immunofluorescence, which is faster and more sensitive than the CF test, has confirmed this lack of a relationship with other virus families and also demonstrated that there is little or no antigenic crossreaction between Marburg and Ebola viruses. The lack of antigenic relatedness is also indicated by the fact that, in laboratory animals, immunity to Marburg virus does not protect against subsequent infection with Ebola.

Immunofluorescence remains the serological method of choice for the detection of filovirus antibodies, although low titre, non-specific results do occur when Ebola virus antibodies are sought. Samples of infected E6 cells, a variant derived from the Vero cell line, are acetone-fixed on to microscope slides and subjected to UV and gamma irradiation to ensure safety (Johnson *et al.*, 1981). An alternative approach is fixation with 3.5% buffered formaldehyde, but subsequent treatment with trypsin or pronase is required to restore full antigenicity (van der Groen *et al.*, 1983). In studies of the seroepidemiology of Ebola virus, fixed substrates of a Sudan strain (Boniface) and a reference Zaire strain (Mayinga) were used to avoid false-negative results due to possible strain variation. ELISA offers an alternative, more sensitive methods, given the availability of Ebola proteins expressed in a baculovirus system.

Specific diagnosis of infection with Marburg or Ebola viruses is generally achieved by demonstrating a rising titre of antibody or by virus isolation. Isolation is best achieved by inoculating blood specimens intraperitoneally into young guinea pigs or on to susceptible cell lines. In the guinea pig, high concentrations of virus are found in the blood during the febrile period, with extensive involvement of the liver, spleen and lymph nodes. Confirmation of infection is made by immunofluorescent staining of infected tissues. Virus cannot be isolated from the blood after the 8th day of illness, although tissue samples taken at autopsy after this time may contain virions. During early passage in cell culture, characteristic intracytoplasmic inclusions containing viral antigen appear in the absence of a visible cytopathic effect; the latter develops only after several passages. Demonstration of viral antigens by immunofluorescence in such infected cultures is therefore preferable.

There have been few studies of immune responses during acute filovirus infection. Teepe *et al.* (1983) described the appearance of antibodies to Ebola virus from day 6 of illness. A rapid rise in titre appeared to be related to recovery. In one person who contracted the infection in a laboratory, antibodies appeared by day 14; but in this patient, treatment with interferon and immune plasma may have altered the development of immunity. Less is known about the time course of immune responses to Marburg virus; limited data show that antibodies may be detected 7–14 days after onset of infection.

Antibodies persist at high titre for at least 1 year but it has not been possible to assess them for neutralization *in vitro*.

At present there are no widely available serological methods, although reagents for immunofluorescence may be obtained from certain laboratories, e.g. the Centers for Disease Control, Atlanta, USA.

CLINICAL AND PATHOLOGICAL ASPECTS

Epidemiology

Outbreaks of human filovirus infection invariably occur in or at the end of the tropical rainy season. All index cases have been in persons living close to tropical rain forests or in the marginal zone between forest and savannah.

Marburg virus

Marburg disease, erroneously referred to in the popular press as *vervet monkey* or *green monkey* disease, was first recognized in 1967, when it caused three simultaneous outbreaks in Europe: at Marburg, Frankfurt and Belgrade (Martini, 1971). There were 31 cases, of which 25 were primary infections; 7 of the primary cases died, but there were no deaths among the 6 secondary cases. A hitherto unknown virus was isolated. All the primary cases were laboratory staff who had come into direct contact with blood, organs or tissue cultures from one particular consignment of *vervet monkeys* imported from Uganda. Four secondary infections were hospital personnel who had come into close contact with patients' blood. The wife of a Yugoslav veterinary surgeon was infected through blood contact with her husband, and a further case was the wife of a patient who transmitted the disease during sexual intercourse 83 days after the onset of illness. *Marburg virus* was detected in his seminal fluid. There were no tertiary cases and the virus did not spread into the community.

The disease next appeared in South Africa in 1975 in a young Australian man who had been hitchhiking through central and southern Africa. He died shortly after admission to a Johannesburg hospital. His female travelling companion and a nurse who looked after him also contracted the

disease. Both women survived. Virological investigations confirmed that the virus isolated from these three cases was morphologically and antigenically identical with *Marburg virus*.

In 1980, *Marburg virus* reappeared, this time in Kenya. A 58-year-old man was admitted to a Nairobi hospital with an 8 day history of progressive fever, myalgia and backache. On admission he was in peripheral vascular failure and bleeding profusely from the gastrointestinal tract. He died within 6 hours of admission. Marburg virus particles were seen by electron microscopy in liver and kidney tissues removed at postmortem examination. Nine days later a doctor who had attended this patient and who had attempted resuscitation became ill with a similar syndrome. He survived, and Marburg infection was confirmed serologically.

Ebola virus

Between June and November 1976, outbreaks of severe and often fatal haemorrhagic fever occurred in the equatorial provinces of the Sudan and Zaire (Figure 20.2). (World Health Organization, 1978). In the Sudan there were 284 known cases, with a case fatality rate of 53%, and in Zaire 318 cases were recorded, with a case fatality rate of 88%. The viruses isolated from patients in both these outbreaks were found to be morphologically identical with Marburg virus but antigenically distinct.

In the two 1976 epidemics, the attack rate in infected communities varied from 3.5 to 15.2 per 1000 in the Sudan and from 8 per 1000 in the centre of the epidemic in Zaire to less than 1 per 1000 in neighbouring communities. These findings indicate that the virus is not as highly transmissible as was previously thought. Both in the Sudan and in Zaire there was serological evidence of small numbers of minor or even subclinical infections. The secondary attack rate was between 13 and 15% in both countries. The epidemics were readily controlled by isolating the patients and instituting strict barrier nursing with gowns, gloves and masks and treatment of patients' excreta with disinfectants such as formaldehyde and hypochlorite.

A second outbreak of Ebola haemorrhagic fever occurred in southern Sudan during August and September 1979, in the same area as the original 1976 outbreak. There were 34 reported cases, of which 22 were fatal. The clinical diagnosis was confirmed by virus isolation and serology.

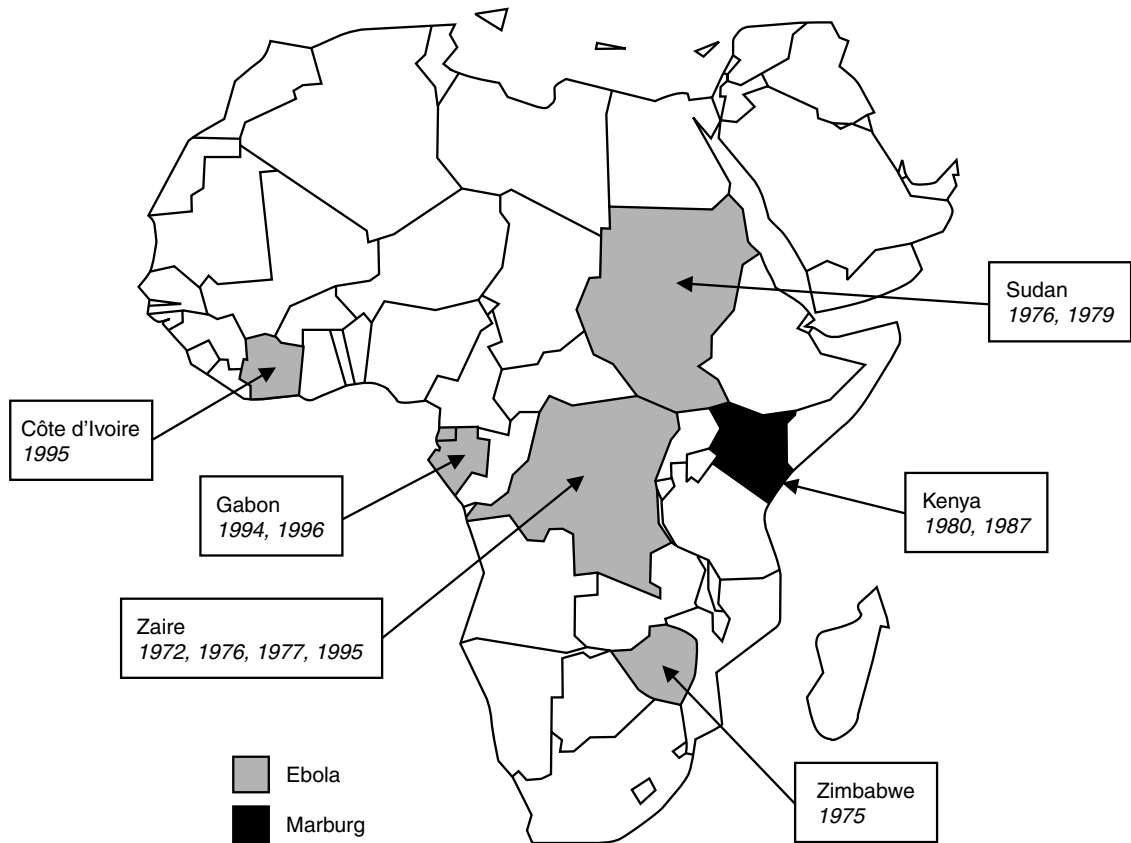

Figure 20.2 Distribution of filovirus outbreaks in Africa

The mechanism of transmission of infection in the outbreaks was mainly by direct contact with infected blood, close and prolonged contact with an infected patient, accidental inoculation or through the use of contaminated syringes and needles. There was no evidence to suggest respiratory spread in the community. All the major African outbreaks have been characterized by spread within hospitals.

A sporadic case was reported in 1977 in Zaire, 325 km west of the centre of the first outbreak (Heymann *et al.*, 1980). A 9-year-old girl was admitted to the Tandala Mission Hospital with a 3 day history of fever, abdominal pain and haematemesis; she died 1 day later. This case is interesting in that the virus was isolated by inoculation of blood into guinea pigs even after shipment to the USA under less than ideal conditions. The case also stimulated a retrospective study of Ebola virus activity in this locality. Another case was a 45-year-old male who had died some months previously after hospitalization with a clinical diagnosis of yellow fever. A

physician was also found to have been infected; he had a history of a febrile illness in 1972 following accidental injury while performing an autopsy on a patient who was also diagnosed as a case of yellow fever (Stansfield *et al.*, 1982). A 7% seroprevalence of Ebola virus antibodies was found among the local population.

In early 1995, a charcoal-maker from near Kikwit in eastern Zaire became the first recognized case of an outbreak that, over the ensuing 6 months, resulted in 315 cases, 77% of which were fatal. The index case transmitted the virus to at least 12 family members. One contact was hospitalized, which may have seeded the outbreak. Shortly afterwards, a resuscitation team became infected after treating a patient misdiagnosed as having typhoid. The outbreak was inflamed by further infection of unprotected health personnel and infected patients being returned into the community. The situation was brought under control by the application of barrier nursing techniques, disinfection and proper

disposal of the deceased. Once again, the failure of local health authorities to recognize the potential problem and to act swiftly led to a severe hospital-focused outbreak.

Ebola virus has also been found in West Africa within the last decade. A female ethnologist became infected when conducting a postmortem examination on a chimpanzee found dead in the Tai National Park, Côte d'Ivoire. This case was only diagnosed retrospectively after repatriation to Switzerland. Since 1994, three apparently independent outbreaks have occurred in Gabon. In July 1996, the largest of these accounted for over 40 deaths; one patient was treated in South Africa, where a fatal nosocomial infection occurred in a nurse.

Ebola virus infection is clearly endemic in northern Zaire. Between 4 and 10% of individuals in the Tandala area were found to be antibody-positive by immunofluorescence. Similar evidence of virus infection has been recorded in other savannah regions of Central and West Africa. Antibodies to both filoviruses have been found in 1–2% of selected populations in Nigeria, up to 10% among pygmies and farmers in the rain forest of the Cameroons and 13% in central Liberia. As with the arenaviruses (Chapter 19), it is likely that severe haemorrhagic fever may represent an unusual human response to these viruses. Cases appear to be most often misdiagnosed as yellow fever. Virus isolation in a laboratory with suitable containment facilities should be attempted whenever possible.

Johnson *et al.* (1983) undertook surveillance for Ebola virus infections following two cases of Marburg infection in the west of Kenya in 1980. Evidence of human Ebola infection was obtained in two cases from the densely populated Mount Elgon region. Both were schoolgirls and serological evidence of infection was obtained in a number of contacts. It is surprising that no evidence of Marburg virus infection was found among the 52 suspected cases of acute viral haemorrhagic fever identified in the 21 month study period. A further study between May 1984 and 1985 revealed that nearly 10% of 471 patients with suspected viral haemorrhagic fever had demonstrable antibodies to Ebola virus; the case fatality rate was 5%, no higher than that in those with no evidence of Ebola virus infection. Antibody rates were higher toward the end of the two wet seasons, and were three times higher in males than in females. This study also

suggested that the virus is neither of the known serotypes but crossreacts with the standard reference strains of *Ebola virus*.

Is There an Animal Reservoir?

There is a strong suspicion that the disease is a zoonosis. Monkeys were originally implicated in the three Marburg outbreaks, but there was a lack of evidence suggesting that primates are among the natural reservoirs of the virus. After the South African cases were identified in 1975, an extensive search for a reservoir was carried out without success. In 1977, large numbers of small animals were caught in the epidemic areas of the Sudan and Zaire, and blood and tissues were removed for investigation in an attempt to throw some light on the natural reservoir for these viruses. Some 200 monkeys and more than 100 other animals were collected in Zaire between 1976 and 1979. No specimens yielded virus and attempts to find Ebola virus antibodies were unsuccessful. However, 26% of peridomestic guinea pigs in the Tandala region proved antibody-positive, although there was no correlation between ownership of positive animals and prevalence of antibody in the households concerned. It appears that the guinea pig is an incidental host that is unlikely to transmit the virus to humans.

Unexpectedly, *Ebola virus* was found during an outbreak of a respiratory disease among macaque monkeys (*Macaca fascicularis*) housed in a commercial quarantine facility in Reston, Virginia. Within 3 years, a similar outbreak occurred in Siena, Italy. The disease showed the clinical signs and pathological lesions typical of Ebola, with the additional feature of large quantities of respiratory secretions. Despite the high titre of virus present (7×10^6 PFU ml⁻¹), there were, fortunately, no cases of human illness among handlers and staff, despite evidence of seroconversion. As these animals originated in the Philippines, the outbreak due to the Reston subtype of Ebola may indicate a non-human primate reservoir in Asia. Extensive follow-up studies in the Philippines have not confirmed this, however, although serological evidence of infection has been found in around 6% of people handling monkeys and working in collection areas. Thus, the identity of any non-human reservoir of filoviruses remains as obscure as ever.

Clinical Features

The human illnesses caused by *Marburg* and *Ebola viruses* are virtually indistinguishable. The incubation period was 3–9 days in both the early German and South African outbreaks of Marburg disease, but in the two Ebola epidemics a wider range of 4–16 days was recorded. Both infections have abrupt onset with frontal and temporal headaches, followed by high fever and generalized pains, particularly in the back. A relative bradycardia is often an early sign. Patients rapidly become prostrated and some develop severe watery diarrhoea, leading to rapid dehydration and weight loss. Diarrhoea, abdominal pain with cramping nausea, and vomiting often persist for a week. In the Sudanese outbreak, knife-like chest and pleuritic pain was an early symptom and many patients complained of a very dry, rather than sore, throat accompanied by a cough. On white skin, a characteristic non-itching maculopapular rash appeared between days 5 and 7, lasting 3–4 days. This was followed by a fine desquamation. On pigmented skin, the rash, often described as measles-like, is not so obvious and is often recognized only when the skin desquamates.

Conjunctivitis was a regular feature in all outbreaks. An enanthem of the palate was reported in the Marburg outbreak in Germany, but not in the three South African cases. In the Sudanese Ebola outbreak, pharyngitis was commonly noted, accompanied by fissuring with open sores on the tongue and lips. Irritation and inflammation of the scrotum or labia majora were common, and orchitis occurred in a few patients. Pancreatitis was noted in several cases.

Patients with Ebola virus infection was usually admitted to hospital on the 5th day of illness; their general appearance was described as ‘ghost-like’, withdrawn, anxious features, expressionless faces, deep-set eyes, a greyish pallor and extreme lethargy. Central nervous system infections were apparent in a number of cases, with signs of meningeal irritation, paraesthesia, lethargy, confusion, irritability and aggression.

Many patients in both the Marburg and the Ebola outbreaks developed severe bleeding between days 5 and 7. The gastrointestinal tract and lungs were most often affected, with haematemesis, melaena and sometimes the passage of fresh blood in the stools. There was also bleeding from the nose,

gums and vagina; subconjunctival haemorrhages were common, as were petechiae and bleeding from needle-puncture sites. Laboratory investigations of the early Marburg-related outbreaks suggested that in some patients there was disseminated intravascular coagulation with subsequent kidney failure. Leucopenia early in the course of illness is a constant feature, followed by leucocytosis and a low erythrocyte sedimentation rate. The acquired Pelger–Huët anomaly of the neutrophils and atypical mononuclear cells have been observed. Thrombocytopenia is recorded in most patients from about day 3 onwards.

Death generally occurs between 6 and 9 days after the onset of clinical disease and is usually preceded by severe blood loss and shock. In surviving patients, recovery is slow and debilitating, frequently accompanied by amnesia, which may persist for many weeks. Abortion is common among pregnant women and the infants born to mothers in the terminal stage of the disease was invariably infected.

It is a feature of filovirus infections that there is no evidence of appreciable virus shedding by any route other than that of haemorrhage. There is no substantial evidence of transmission by aerosol and very little virus in the throat or urine, but the persistence of virus in some body fluids up to 83 days after onset does pose a risk of late transmission. One of the South African Marburg patients developed uveitis 2 months after recovery, with virus successfully cultured from fluid aspirated from the anterior chamber. Experience in the 1995 Kikwit outbreaks shows that the skin may also harbour virus; thus, the mere touching of an infected person may allow the virus to spread.

Isolation of patients, rigorous adherence to aseptic techniques and the adoption of precautions for enteric-type diseases are a minimum for adequate biological containment of these viruses. As stressed above, the handling of specimens for virus serology and isolation requires biosafety level 4 facilities.

Pathology

Marburg and *Ebola viruses* are pantropic and produce lesions in nearly every organ, the liver and spleen being the most affected. At autopsy, there is swelling of the spleen, lymph nodes and kidney. Haemorrhage occurs into the skin, mucous mem-

branes and gastrointestinal tract, the stomach and parts of the intestines usually being filled with blood. Petechiae are seen in the mucosae of the stomach and small intestine. Vascular changes include haemorrhages, occlusions and thromboses.

Histological examination of the liver and lymphoid tissue enables a reasonably accurate diagnosis. There is severe degeneration of lymphoid tissue, with necrosis in the spleen and liver. Focal hepatic necrosis is accompanied by the formation of eosinophilic bodies—resembling the Councilman bodies of yellow fever—and smaller, basophilic inclusions; both types can also be seen in most other tissues. The fatty changes within hepatocytes, so characteristic of yellow fever, are however, slight. Mononuclear cells accumulate in the peripheral spaces. Even at the height of the necrotic process in the liver there is evidence of hepatocyte regeneration. High concentrations of virus are found by electron microscopy in the necrotic area.

Necrotic lesions are also found in the pancreas, gonads, adrenals, hypophysis, thyroid, kidney and skin. Severe congestion and stasis are obvious in the spleen. There are few lesions in the lungs except for circumscribed haemorrhages and endarteritis, especially of arterioles. Neuropathological changes are confined mainly to the glial elements throughout the brain. Congestion of meningeal and intracerebral blood vessels has been noted in the brains of experimentally infected rhesus monkeys, possibly indicating early thrombosis and consistent with the confused behaviour and other neurological signs in many patients with Ebola virus infection.

Acute Ebola virus infection in rhesus monkeys closely resembles the illness in humans. A sequential study in infected monkeys has emphasized the importance of widespread injury to small blood vessels and capillaries in all organs (Baskerville *et al.*, 1985). The endothelial necrosis accompanying virus replication leads to the separation of junctions between epithelial cells and detachment from basement membranes. In turn, these focal lesions result in haemorrhage and oedema, leading to hypovolaemic shock. Defective platelet aggregation precedes a fall in the platelet count, and the prolongation of coagulation times suggests a defect in prothrombin production. The late stages of the disease are accompanied by extensive intravascular fibrin deposition and an increase in fibrin degradation products. The end result is a generalized loss of epithelial integrity, leading to the sudden develop-

ment of haemorrhage and shock.

The profound leucopenia may result from the neutrophil inactivation by soluble (sGP) protein secreted from virus-infected cells. It has been postulated that this is mediated by CD16 molecules which are exclusively found on neutrophils and represent the IgG Fc receptor IIIb (Yang *et al.*, 1998). This is paralleled by virus infection of mononuclear phagocytes and the fibroclastic reticular system, thereby disrupting antigen processing and cytokine production. The major envelope glycoprotein GP possesses a likely immunosuppression motif which may also contribute to the host's failure to mount an effective immune response. There is evidence that GP2 binding to epithelial cells is sufficient to trigger the haemorrhagic manifestation of the disease.

Treatment and Prevention

At present there is no specific treatment for filovirus infections. The anticipation of complications, such as shock, cerebral oedema, renal failure and hypertension, can do much to improve management, and supportive care is essential. Anticoagulant therapy has been used for two patients with Marburg infection (Gear *et al.*, 1975), although the use of heparin remains controversial. Human interferon and immune plasma were used to treat one laboratory worker accidentally infected with a Sudan isolate of Ebola virus, but their relative contribution to the patient's eventual recovery is not clear. Viraemia decreased by over 4 logs soon after transfusion, and 7 days later virus could not be isolated.

Although difficult to interpret, this finding initially encouraged the collection of immune plasma for future emergencies. No vaccine is available for these diseases, although such a product would be of value for protecting healthcare personnel in Africa and laboratory staff who handle tissues and cells from captured wild monkeys.

Attempts to formulate a vaccine have focused on stimulating antibodies to the major envelope protein (GP). DNA immunization using a plasmid expressing Ebola GP protected guinea pigs against challenge (Xu *et al.*, 1998). However, neutralizing domains are also present on the secreted form, thus sGP may adsorb neutralizing antibodies *in vivo*. This may explain the difficulties in detecting neu-

tralizing antibodies in patients' sera. It is clear that much more needs to be known about the properties of these viruses and the diseases they cause before the development of effective vaccines is realized.

There is evidence to suggest that high titre antibodies are useful for postexposure prophylaxis and there are several anecdotal accounts of successful infusion of whole blood and plasma obtained from convalescent patients. These do not constitute a rational basis of postexposure therapy, however, but offer promise that human monoclonal antibodies may either be protective or therapeutic, or both.

REFERENCES

- Baskerville, A., Fisher-Hoch, S.P., Neilds, G.H. *et al.* (1985) Ultrastructure pathology of experimental Ebola haemorrhagic fever virus infection. *Journal of Pathology*, **147**, 199–209.
- Casals, J. (1971) *Marburg Virus Disease* (eds G. Martini and R. Siebert), p98. Springer, New York.
- Elliott, L.H., Kiley, M.P. and McCormick, J.B. (1985) Descriptive analysis of Ebola virus proteins. *Virology*, **1**, 169–176.
- Ellis, D.S., Simpson, D.I.H., Francis, D.P. *et al.* (1978) Ultrastructure of Ebola virus particles in human liver. *Journal of Clinical Pathology*, **31**, 301–308.
- Ellis, D.S., Stamford, S., Tvoey, D.G. *et al.* (1979) Ebola and Marburg viruses: II. Their development within Vero cells and the extra-cellular formation of branched and torus forms. *Journal of Medical Virology*, **3**, 213–225.
- Feldman, H., Klenk, H.D. and Sanchez, A. (1993) Molecular biology and evolution of filoviruses. *Archives of Virology Supplement*, **7**, 87–100.
- Gear, J.S.S. (1975) Outbreak of Marburg virus disease in Johannesburg. *BMJ*, **4**, 489–493.
- Gear, J.S.S. (ed.) (1988) *Viral and Rickettsial Hemorrhagic Fevers*. Chemical Rubber Company Press, Boca Raton FL.
- Heymann, D.L., Weisfeld, J.S., Webb, P.A. *et al.* (1980) Ebola haemorrhagic fever: Tandala, Zaire, 1977–1978. *Journal of Infectious Diseases*, **56**, 247–270.
- Johnson, B.K., Ocheng, D., Gitau, L.G. *et al.* (1983) Viral haemorrhagic fever surveillance in Kenya, 1980–1981. *Tropical and Geographical Medicine*, **1**, 43–47.
- Johnson, K.M., Elliott, L.H. and Heymann, D.L. (1981) Preparation of polyvalent viral immunofluorescent intracellular antigens and use in human serosurveys. *Journal of Clinical Microbiology*, **5**, 527–529.
- Lloyd, G. (1998) Marburg and Ebola viruses. In *Zoonoses* (eds S.R. Palmer, L. Soulsby and D.I.H. Simpson), pp 387–399. Oxford University Press, Oxford.
- Martini, G.A. (1971) Marburg virus disease, clinical syndrome. In *Marburg Virus Disease* (eds G.A. Martini and R. Siebert), pp 1–9. Springer, New York.
- Mitchell, S.W. and McCormick, J.B. (1984) Physicochemical inactivation of Lassa, Ebola and Marburg viruses and effect on clinical laboratory analyses. *Journal of Clinical Microbiology*, **3**, 486–489.
- Murphy, F.A. and Peters, C.J. (1998) Ebola virus: where does it come from and where is it going? In *Emerging Infections* (ed. R.M. Krause), pp 375–410. Academic Press, San Diego.
- Richman, D.D., Cleveland, P.H., McCormick, J.B. *et al.* (1983) Antigenic analysis of strains of Ebola virus: identification of two Ebola virus serotypes. *Journal of Infectious Diseases*, **2**, 268–271.
- Sanchez, A. and Kiley, M.P. (1987) Identification and analysis of Ebola virus messenger RNA. *Virology*, **2**, 414–420.
- Sanchez, A., Trappier, S.G., Mahy, B.W. *et al.* (1996) The virion glycoproteins of Ebola viruses are encoded in two reading frames and are expressed through transcriptional editing. *Proceedings of the National Academy of Sciences of the USA*, **8**, 3602–3607.
- Stansfield, S.K., Scribner, C.L., Kaminski, R.M. *et al.* (1982) Antibody to Ebola virus in guinea pigs: Tandala, Zaire. *Journal of Infectious Diseases*, **4**, 483–486.
- Suzuki, Y. and Gojobori, T. (1997) The origin and evolution of Ebola and Marburg viruses. *Molecular and Biological Evolution*, **14**, 800–806.
- Teepe, R.G.E. (1983) A probable case of Ebola virus haemorrhagic fever in Kenya. *East African Medical Journal*, **60**, 718–722.
- van der Groen, G., Kurata, T. and Mets, C. (1983) Modifications to indirect immunofluorescence tests on Lassa, Marburg and Ebola material. *Lancet*, **i**, 654.
- World Health Organization (1978) *Bulletin of the World Health Organization*, **56**, 247 and 271.
- Xu, L., Sanchez, A., Yang, Z. *et al.* (1998) Immunisation for Ebola virus infection. *Nature Medicine*, **4**, 37–42.
- Yang, Z., Delgado, R., Xu, L. *et al.* (1998) Distinct cellular interactions of secreted and transmembrane Ebola virus glycoproteins. *Science*, **279**, 1034–1037.

Rabies

Karl G. Nicholson

Leicester Royal Infirmary, Leicester, UK

INTRODUCTION

Rabies is an acute infectious encephalomyelitis caused by a rhabdovirus. It is distributed globally among a variety of warm-blooded species, primarily the *Canidae* and *Chiroptera*. Infection occurs occasionally in humans, the disease being characterized by a lengthy incubation period, a plethora of central nervous system disturbances often including hydrophobia, and almost inevitably by death. The classical Greeks knew rabies as *lyssa* or *lytta*, meaning madness. The Latin word *rabies* comes from the Sanskrit *rabhas* denoting madness or rage.

Remarkably little was known of the disease agent until the early twentieth century when Negri in 1903 first visualized darkly staining inclusions in certain nerve cells in the brains of rabid animals. He considered incorrectly the inclusions to be protozoan; none the less his discovery was of major diagnostic importance. The year 1903 also saw Remlinger's filtration experiments establish the agent to be of ultramicroscopic proportions, a finding confirmed soon afterwards by centrifugation studies. A further 30 years elapsed, however, before ultrafiltration analysis suggested a value of 100–150 nm for the particle diameter, a reasonable approximation of today's accepted figure. Matsumoto first visualized the virus by electron microscopy in 1962, though its similarity to the *Rhabdoviridae* was not recognized until 1963 when it was also identified as an RNA-containing virus.

THE VIRUS

Classification

Rabies virus belongs to the family *Rhabdoviridae* (from Greek *rhabdos*, rod), a name referring to the bullet-shaped or bacilliform morphology of its members. Approximately 80 other bullet-shaped viruses have now been recovered from a variety of plants and animals, including fish and insects. The *Rhabdoviridae* contain a negative-sense genome of single-stranded RNA and are divided into two genera which infect invertebrates, the genera *Vesiculovirus* and *Lyssavirus*, with rabies and the serologically-related Lagos bat, Mokola, Duvenhage, and European bat lyssaviruses types 1 and 2 belonging to the latter (Table 21.1). With the exception of rabies, the members of the *Lyssavirus* genus rarely cause human disease. Rabies isolates from animals infected naturally are generally referred to as 'street' virus. In contrast, the term 'fixed' was first applied by Pasteur to describe the highly reproducible biological properties which appeared after intracellular passage of street virus in rabbits; it is now also applied to viruses passaged in avian embryos or tissue culture and having characteristic biological behaviour.

Rabies and Related Viruses

Lyssaviruses can be classified provisionally into six genotypes. The viruses were classified originally

Table 21.1 Members of the genus *Lyssavirus* of *Rhabdoviridae*

Serotype	Virus	Species distribution	Geographical distribution
1	Rabies	Many warm-blooded animals	Worldwide, except for a few islands, peninsular land masses, Australasia and Antarctica
2	Lagos bat	Bats, cats	Nigeria, Central African Republic, South Africa, Senegal, Ethiopia
3	Mokola	Shrews, humans, dogs, cats	Nigeria, Cameroons, Zimbabwe, Central African Republic, Ethiopia
4	Duvenhage	Humans, bats	South Africa
5	EBL1	Humans, bats	Europe
6	EBL2	Humans, bats	Europe
—	Kotonkan	<i>Culicoides</i>	Nigeria
—	Obodhiang	Mosquitoes	Sudan
—	Rochambeau	Mosquitoes	French Guiana

into four serotypes on the basis of serological and antigenic relationships. Genetic studies have confirmed and extended this classification and four genotypes corresponding to the original four serotypes have been characterized. Serotype 1 contained all street and vaccine strains of rabies virus which infect a wide range of species in nature and include viruses responsible for historical disease syndromes such as 'oulo fato' in African dogs, Nigerian horse 'staggers', 'derriengue' in vampire bats, and 'polar madness' in Arctic foxes.

Lagos bat virus, the prototype strain of serotype 2, was first isolated from the pooled brains of bats in Nigeria and is probably enzootic in fruit bats throughout Africa. It has been identified in a region encompassing Nigeria and Senegal in West Africa, the Central African Republic and Zimbabwe, South Africa and Ethiopia in north-east Africa, principally in bats but also in the domestic cat. It is the only one of the six genotypes not to have been associated with disease in humans. *Mokola virus*, the prototype strain of serotype 3, was first isolated from the pooled viscera of shrews in Nigeria and then from two Nigerian children with convulsions and a poliomyelitis-like illness, one of whom died. Further isolates were made from shrews in the Cameroons and the Central African Republic, from dogs in Zimbabwe, and from domestic animals in Ethiopia. The prototype virus of serotype 4, *Duvenhage virus*, was first recovered from the brain of a human bitten on the lip by an insectivorous bat in South Africa. The man died of a rabies-like illness, and the virus was subsequently isolated directly from bats in South Africa. The recently identified *European bat lyssavirus 1* and 2 (EBL1 and EBL2) have been classified into

genotypes 5 and 6. Three other lyssaviruses that belong to the rabies sero-group are *Kotonkan virus* and *Obodhiang virus*, which were isolated from *Culicoides* mosquitoes in Nigeria and Sudan, and *Rochambeau virus*, isolated from mosquitoes in French Guiana.

'Rabid' bats in Europe were reported as early as 1954 in an unidentified species from Hamburg, Germany, and in three *Nyctalus noctula* bats in Yugoslavia. Subsequently similarities were identified between Duvenhage and bat isolates from maritime Germany, which led to the assumption that Duvenhage virus had been imported by bats carried by boat from South Africa. However, monoclonal antibodies have revealed a clear distinction between Duvenhage and EBL1 and EBL2, which have been identified in European bats of at least eight different species, ranging over a geographic area from the Ukraine to Spain. *Eptesicus serotinus* appears to be the principal reservoir for EBL1 and *Myotis dasycneme* and *M. daubentonii* the reservoirs for EBL2. EBL2 caused the death of a zoologist in Finland in 1985, and two deaths from infection with EBL1 have been recorded in the former Soviet Union. Over a period of 10 years, 1986–1995, 1882 bats belonging to 23 species of bat from all parts of England were examined for the presence of rabies antigen; all were found to be negative, suggesting that EBL is not endemic in Britain. However, in June 1996, EBL2 was isolated from a Daubenton's bat (*M. daubentonii*) in Newhaven, East Sussex. It is conceivable that this bat originated from mainland Europe and it is questionable whether EBL is enzootic in Britain.

The European bat epizootic has been identified

principally in north-central Europe and over recent years has shifted from Denmark to Northern Germany and the Netherlands. Sporadic cases have been identified in eastern Germany, Spain, the former USSR and Czechoslovakia, France and Poland. Evolutionary analysis of the nucleoprotein gene of EBL1 and EBL2 indicates that both viruses evolved into two genetically distinguishable lineages (a and b) following geographical drifting. It has been suggested that subsequent lineages EBL1a and EBL1b were introduced into parts of northern Europe from different directions; EBL1b was introduced most recently, probably from North Africa. Although Australia is rabies-free, bat lyssavirus infection was identified in Queensland in two black flying foxes (*Pteropus alecto*, fruit bats) in 1996 and in one little red flying fox (*P. scapulatis*) in 1995. Apart from the three human cases of EBL infection, there is no evidence of natural transmission of EBL to other species. The generally low prevalence of EBL does not justify specific control measures. However, in both rabies-free and rabies endemic areas the public should be warned not to handle bats that appear sick or behave strangely, e.g. daytime flying or entering houses, and bat handlers should be encouraged to wear gloves. Mouse protection studies reveal little or no protection against EBL viruses from inactivated Pitman Moore rabies virus, which is used widely in rabies vaccine production. Rabies vaccines also provide negligible or no protection against *Lagos bat virus*, *Mokola virus* or *Duvenhage virus*.

Members of the genus *Lyssavirus* contain a common cross-reacting N protein which can be detected by standard fluorescent antibody, complement fixation and precipitation techniques. They are distinguished by virus-neutralization and cross-protection tests, indicating that their surface glycoproteins are different. The application of monoclonal antibody technology to the study of antigenic relationships among rhabdoviruses has confirmed the distinction between rabies and rabies-related viruses and has revealed extensive antigenic variation in both glycoprotein and nucleocapsid proteins of a number of laboratory and street strains of rabies virus. There are marked differences between different strains of virus in their ability to infect, spread within the body and produce disease, and *in vitro* biological studies and nucleotide sequence studies also reveal distinct differences. Polymerase chain reactions (PCRs), using primers speci-

fic for rabies virus variants that can not be distinguished by antigenic typing with currently available monoclonal antibodies, are being used for epidemiological monitoring of oral rabies vaccination programmes of wildlife.

Analysis of several hundred isolates from animals and humans in different parts of the world has revealed both geographical and species patterns of reactivity with monoclonal antibodies. Similarly, live virus strains used for the immunization of animals can be distinguished from wild-type viruses. When the antigenic makeup of a large number of field isolates were compared with that of the PM-HDCS vaccine strain, the percentage of common antigenic determinants ranged from 44 to 100%. Despite these differences the current tissue culture vaccines for use in humans have worldwide applicability, as judged by the lack of reports of vaccine failures in specific geographical locations or failures related to one or more animal species. Moreover, studies in mice indicate that immunization with fixed *Rabies virus* provides protection against isolates representing the spectrum of street rabies virus variants found worldwide. Thus there is no evidence that antigenic differences account for vaccination failures.

Morphology

Rabies virus is an enveloped, bullet-shaped, negative-stranded RNA virus with average dimensions of approximately 200 × 75 nm. Variations in length are seen with different rabies virus strains. The particles are composed of a compact helical nucleocapsid of 30–35 coils, which are seen as cross-striations by electron microscopy of negatively stained virus particles. The nucleocapsid, or ribonucleoprotein complex, is surrounded by a lipid bilayer, 7.5–10 nm thick, associated with two protein species, M2 which is internal, and G which is a glycosylated transmembrane protein. The surface of the virion is covered with spike projections 8 nm long with knob-like structures at their distal end (Gaudin *et al.*, 1992). By electron microscopy it appears that the surface projection layer is arranged in triangles. The protrusions are absent at the base, which is frequently invaginated, forming a hollow axial channel. In addition to the typical virus particles, anomalous forms such as short, V- and Y-shaped



Figure 21.1 Electron micrograph of the rabies virus

virions have been described. Rabies defective interfering (DI) particles measuring 70–100 nm in length contain RNA and are similar antigenically to full-length particles. Although they interfere with the replication of full-length virions they cannot replicate in their absence. The electron microscopic appearance of rabies virus particles is shown in Figure 21.1.

Chemical Structure

The gross chemical structure of rabies virus has been estimated. Each particle is composed of approximately 24% lipids, 3% carbohydrates, 1% RNA and 72% protein. The single strand of RNA is non-infectious. It has a molecular weight of $3.8\text{--}4.6 \times 10^6$, a sedimentation coefficient of 45S, a buoyant density in Cs_2SO_4 of 1.66 g m^{-1} , and when uncoiled is about $4.2 \mu\text{m}$ long.

The non-segmented, single-stranded RNA genome of the Pasteur virus (PV) strain contains 11 932 nucleotides (Tordo *et al.*, 1986), whereas that of the SAD-B19 strain contains 11 928 bases. These encode in order from the 3' end, the leader RNA, and five polyadenylated monocistronic mRNAs for nucleoprotein N, the phosphoprotein M1, the matrix or membrane protein M2, the glycoprotein G and the large RNA-dependent RNA polymerase L protein. The relative molecular masses and number of copies of each protein per virion differ between studies, possibly reflecting differences in the methods used and the viral strains studied. The helical ribonucleoprotein core consists of the genomic RNA so tightly bound to the ~ 1800 mol-

ecules of the phosphorylated N (nucleoprotein) that it is resistant to RNase, and less tightly bound with the M1 phosphoprotein (initially thought to be a non-structural (NS) protein) and L protein. This ribonucleocapsid complex is surrounded by a lipid bilayer associated with the internal M2 protein and G transmembrane protein.

N Protein

The nucleoprotein segment of the PV rabies virus genome contains 1350 nucleotides and shares with *Vesicular stomatitis virus* (VSV) four particularly conserved regions (Tordo *et al.*, 1986, 1988). N protein is a 450 amino acid long polypeptide. Studies of the amino acid sequences of CVS-11, ERA and PV strains reveal a high degree of similarity: the N proteins of ERA and PV differ by only four amino acids (99% homology), and those of CVS-11 and ERA differ by only nine amino acids, giving 98% homology. N protein is produced abundantly during viral replication and lyssavirus group specificity is determined by its cross-reactivity. The antibody-binding epitopes on N protein distinguish rabies from the rabies-related viruses. Accordingly it has an important role in diagnosis. Three antigenic sites have been identified and several T helper epitopes have also been identified, at least one of which is involved in protection. Studies with N and M1 proteins produced using baculovirus expression vectors show that N and M1 form complexes (Préhaud *et al.*, 1992). The N protein is less variable than the other proteins and is considered to be the best candidate for extending the protective spectrum of vaccines to include the rabies-related viruses. Neurotissue vaccines contain considerably more N protein than cell culture vaccines.

M1 Phosphoprotein

The rabies virion contains approximately 1750 molecules of M1 phosphoprotein, otherwise known as NS protein, which is highly hydrophilic and is 297 and 303 amino acids long in rabies and Mokola virus, respectively. Its nucleotide sequence is poorly conserved, especially in the central region. The role of the M1 protein is probably regulatory and is believed to help the RNA-dependent RNA polymerase bind to the promoter for polymerization. When these proteins were coexpressed via the vaccinia virus T7 RNA polymerase recombinant in

mammalian cells, they formed a complex involving the carboxy-terminal domain of L protein.

M2 Protein

The M2 protein, otherwise known as M protein, is 202 amino acids long and each rabies virion contains approximately 1650 molecules. It is located between the viral nucleocapsid and viral membrane, probably interacting with both and playing an important role in the morphogenesis of the virus. A major antigenic determinant has been identified between residues 1 and 78 and it may be involved in the host immune response to rabies.

Glycoprotein G

The glycoprotein G (molecular weight 70 500), which is the only protein external to the virion, is required for virus infectivity. The rabies virion contains approximately 1800 molecules of the glycoprotein G. It is also responsible for the recognition of specific cell-surface receptors, bears the fusion properties of the virus (Gaudin *et al.*, 1993), and induces and reacts with virus neutralizing antibody and complement-fixing antibody which lyses infected cells. G protein also induces cellular immune responses involving both T helper cells and cytotoxic T cells. The amino acid sequence of the glycoprotein from several laboratory strains of rabies virus and a number of mutants has been deduced from the nucleotide sequence of cloned complementary DNA. The amino acid sequences of the glycoproteins of human and canine street rabies virus strains have also been determined by sequencing PCR-amplified glycoprotein genes (Benmansour *et al.*, 1992). The deduced polypeptide for canine street rabies virus contains 524 amino acids and is equivalent in size and organization to previously characterized glycoproteins. Similarly the G protein of Mokola virus is 522 amino acids long.

The rabies G protein consists of a signal peptide of 19 amino acids, an ectodomain of 439 amino acids, a transmembrane domain of 22 amino acids, and a cytoplasmic domain of 44 amino acids (Benmansour *et al.*, 1992). The 19 residue terminal signal initiates the translocation of the protein through the rough endoplasmic reticulum before being cleaved. The glycoprotein of a canine street rabies virus displayed 10% divergence in overall amino acid composition compared to CVS fixed virus, but the

differences were not distributed equally throughout the three domains of the glycoprotein. In the ectodomain, only a 6% difference was observed, whereas there was 27% divergence in the cytoplasmic domain and 41% in the transmembrane domain. Panels of monoclonal antibodies directed against glycoprotein G have allowed the construction of functional antigenic maps. At least eight antigenic sites have been identified in the ectodomain of different rabies strains and more than one site is evidently involved in determining virulence.

Site III, which is linear and extends from amino acid 330 to 338, is implicated in the recognition of specific receptors present on nerve endings, and mutations at amino acid 333 modify the host-range spectrum of the virus (Kucera *et al.*, 1985). Mutations at antigenic site II, especially those affected in amino acid 198, have reduced pathogenicity (Préhaud *et al.*, 1988). The glycoprotein has also been fragmented and the fragments tested for their ability to evoke neutralizing antibody synthesis and reactivity with virus-primed T lymphocytes. Here again it appears that specific immunological functions are associated with different regions of the molecule.

L Protein

The L gene of the PV strain encodes a single open reading frame 2142 amino acids in length (244 206 Da) that corresponds to the viral RNA-dependent RNA polymerase and shows a high degree of homology with the VSV polymerase. The L protein of the SAD-B19 strain is 2127 amino acids long. One-third of the amino acids are in identical positions to those of VSV polymerase and some stretches are homologous with those of Sendai virus and Newcastle disease virus, suggesting that rhabdoviruses and paramyxoviruses are evolutionary related (Tordo *et al.*, 1988). Each virion contains an estimated 20–150 molecules of L protein.

Replication

The binding of *Rabies virus* to its receptor is believed to be mediated by the surface glycoprotein. The virus enters the cell by pinocytosis and the viral membrane fuses with the membrane of the lysosomal vacuole to release the ribonucleocapsid into the cytoplasm. Virus replication takes place within

the cellular cytoplasm and the general scheme of rabies RNA transcription is believed to be similar to VSV and other non-segmented negative-stranded RNA viruses. It proceeds via the formation of a full-length positive RNA copy that is an intermediate of genome replication, and five polyadenylated complementary monocistronic messenger (m) RNAs. Transcription proceeds under the control of the L protein, the RNA-dependent RNA polymerase, which is included in the nucleocapsid. The mRNAs attach to membrane-bound polysomes or cytoplasmic ribosomes for synthesis of their respective protein molecules (translation). However, the G protein is produced in the rough endoplasmic reticulum and is transported via the Golgi apparatus to the cytoplasmic membrane of the cell before virion assembly. In common with other negative-strand RNA viruses, the newly synthesized plus-stranded RNA eventually stops being generated into the form of multiple mRNA species; instead it serves as template to synthesize the progeny negative-stranded RNA molecules, the L protein probably acting as the replicase in such a reaction. Subsequently, the genomic RNA associates with N, M1 and L proteins to form the nucleocapsid which migrates to cell membranes, these being converted into virion envelope by insertion of proteins G and M2. New virions are formed by a process of budding through the cell membrane.

Effects of Physical and Chemical Agents

Rabies virus is inactivated below pH 4 and above pH 10. It has a half-life of about 4 hours at 40°C and is inactivated within 10 minutes at 60°C, but is stable for several days at 0–4°C. It is also resistant to repeated freezing and thawing. The virus is sensitive to quaternary ammonium disinfectants (e.g. benzalkonium and cetrimonium at dilutions of 1/1000), 1% soap solutions, ionic and non-ionic detergents, 5% iodine, most common organic solvents (45% alcohol, ether and chloroform), formalin, β -propiolactone, acetyleneimine, tri(n-butyl) phosphate, proteolytic enzymes, ultraviolet (UV) light and ionizing irradiation. It is more resistant to 0.25–0.5% phenol used in Semple-type vaccines where several days are required to completely inactivate the virus. An important component of postexposure treatment is the thorough cleansing of the wound with soap or detergent.

In Vitro Growth

Rabies virus has been adapted to growth in a wide variety of primary and continuous cell systems, not only cells from warm-blooded animals but also ones of poikilothermic vertebrate origin. The BHK-21 cell line is used most commonly in rabies research because of its high susceptibility to fixed strains of virus, high virus yields and lack of cytopathic effect. Street *Rabies virus* cannot be grown consistently in hamster kidney cells. Murine neuroblastoma (NA C1300) cells are the most susceptible to street rabies virus infection and comparison with the mouse inoculation test indicate that a rabies tissue culture infection test using mouse neuroblastoma cells is at least as efficient as the *in vivo* test, but the tissue culture based test is much quicker and less expensive.

Human diploid cells are used to produce rabies vaccines with well-established records of safety, potency and postexposure efficacy, but the poor growth characteristics of virus in diploid cells make vaccine production very expensive. Vero cells, a continuous line of African green monkey cells, yield more virus than human diploid cells and the culture of Vero cells on microcarriers in large scale bioreactors has made possible the production of rabies vaccines at an industrial scale at comparatively low cost. *Rabies virus* has long been adapted to growth in developing avian embryos for the purpose of vaccine production, though only recently have modern purification techniques allowed the development of a highly potent product. Virus infectivity in tissue culture is generally augmented by diethylaminoethyl-dextran or protamine sulphate. Fluorescence appears about 12 hours after infection, with higher yields of virus at 33°C than 37°C. Cytopathic effects and plaque formation occur with some cell systems and virus strains, but in most cell types cytological changes are absent.

Epidemiology

Animal Rabies

Rabies is enzootic in all continents except Australasia and Antarctica. Most other disease-free areas are islands or, less commonly, peninsular land masses where stringent quarantine regulations can be regularly enforced. All warm-blooded animals

are susceptible to the virus, including birds, although these are rarely if ever infected in nature. The disease exists in two epidemiological forms: urban rabies, which is propagated chiefly in feral and domestic dogs and is prevalent in many developing countries of the world; and sylvatic rabies, which occurs in a wide range of species, principally small carnivores and mustelids.

Globally, rabies is most prevalent among wild canids (foxes, wolves, jackals), followed by domestic dogs, skunks, farm animals, cats, bats, mongooses and other species. However diagnostic and other facilities are limited in many developing countries and the number of cases among domestic dogs is probably grossly underestimated.

Extensive surveys show rodent rabies to be extremely uncommon. Rabies is unusual among lagomorphs (i.e. rabbits and hares) and insectivores (i.e. shrews, moles and hedgehogs), though mustelids (i.e. skunks, weasels, badgers and martens) and the Viverridae (i.e. mongoose, suricate, ferret, genet, civet cat and polecat) are regularly found to be infected. Non-human primates are infected occasionally and isolated cases have been reported throughout Africa, South America and parts of Asia. Among the wild Felidae, sporadic cases have been identified in lions, hyaenas, leopards, cheetahs, lynxes, tigers and ocelots. Rabies among wild ungulates is identified regularly in central European deer, and is recorded in camels in North and West Africa, India, and the Near and Middle East; kudu and eland antelopes in South-West Africa; and occasionally in buffalo and moose in North America. The Chiroptera are of major importance as reservoirs and transmitters of infection in the Americas. In Latin America bites by haematophagous vampire bats cause occasional human deaths and losses of more than 100 000 cattle each year. In the United States bats represent the most widely distributed vector, and the silver-haired bat variant has been identified as the aetiological agent of a number of recent human rabies cases. In Europe and Australia infection with bat lyssaviruses has been reported but seems rare.

In Europe the major reservoir of infection is the red fox: in 1992 there were over 11 000 reported cases of animal rabies in Europe, 66% of which occurred in foxes. Martens, deer, badgers and other animals are involved much less frequently. As in the United States, domestic species in Europe account for only a small percentage (10–15%) of the total

infected population. Field trials to immunize foxes against rabies began in Switzerland in 1978 and since then oral immunization of wildlife with baits containing live attenuated rabies virus (or recombinant vaccinia virus expressing the glycoprotein of rabies virus), dispersed by air, has been applied widely throughout Europe. By this means the incidence of rabies in France declined by 98% during the period 1989–1994 and large areas of France are now rabies free. Similarly in Belgium in 1995 the disease was eliminated from 80% of the areas infected initially, and in the Czech Republic, the number of rabies cases fell from 1501 cases at the start of the programme to 221 in 1994. The overall success of these programmes is illustrated by figures on the number of rabies cases reported in Europe: in 1983 the number totalled 23 002 cases; by 1995 it had fallen to 8134. However, experience has shown that the elimination of rabies depends upon repeated vaccination programmes, continuous surveillance, with particular attention to cross-border contamination, and subsequently restricted targeted vaccination campaigns.

The epidemiology of rabies in the United States has changed since the 1940s, from domesticated animals (mostly dogs) to wildlife vectors, principally skunks, bats and racoons. Raccoon rabies, epizootic among racoons in the south-eastern and mid-Atlantic states, has become an increasingly important problem in the eastern United States: the extension of the epizootic was largely responsible for a 43% increase in the total number of cases between 1990 (4881) and 1991 (6975); in 1991, 3079 cases in racoons were reported. The epizootic was probably introduced into the mid-Atlantic region in the mid-1970s when racoons were transported from the south-eastern United States to the mid-Atlantic area to replenish hunting stocks. In 1994, 8224 cases of rabies were reported in the United States, 93% of which (7632 cases) were wild animals. The striped skunk is a host of rabies in large areas of Canada and the United States. In Canada, foxes account for 40% of all cases nationally. The success of campaigns in Europe to eliminate fox rabies has encouraged efforts in North America to control sylvatic rabies in coyotes, racoons and foxes. In the United States, preliminary data indicate a significant reduction in the incidence of rabies in vaccinated areas and expansion of a rabies epizootic involving coyotes ceased.

In Africa, Mexico, Central and South America,

Asia and Asia Minor the dominant reservoir is found in unvaccinated domestic dogs, which account for 85% of recognized cases. The degree of involvement of wildlife species in tropical regions is largely unknown. To prevent or eliminate outbreaks of canine rabies, the World Health Organization (WHO) recommends that 70% of dogs in a population be immunized. This percentage has been determined empirically from observations on the relationship between vaccine coverage and the incidence of rabies in dog populations around the world. Since this level of coverage is not attainable readily and serological responses may be suboptimal or of short duration, efforts are being directed at immunizing free-roaming domestic dogs using baits containing rabies vaccine. The possible use of oral modified live rabies vaccine to control rabies in jackals in Zimbabwe is also under consideration and a candidate virus has been tested for immunogenicity and safety in potential non-target bait-consuming species.

Human Rabies

There is little reliable information concerning the extent of human rabies or relative risk of exposure in many regions of the developing world, so the true extent of the disease in humans is uncertain. In 1992, a total of 36 001 cases of human rabies were reported worldwide to the WHO. Human rabies occurs mostly throughout the Indian subcontinent, south-east Asia, much of Africa, Central and South America, and Mexico, where the virus is propagated chiefly in feral and domestic dogs. Only a few endogenous cases occur in Europe and North America despite the presence of sylvatic rabies in a number of animal species. Nonetheless, the estimated costs associated with the decrease in deaths in the United States is estimated at hundreds of million dollars annually.

The official reports of human rabies probably underestimate its true incidence, which may account for as many as 100 000 deaths annually. The official data should be interpreted with caution since many outlying villages in developing countries do not report rabies, yet as many as three-quarters of the cases are believed to occur in rural areas, where access to medical and diagnostic facilities is often poor. Of the cases that reach hospital, many undoubtedly are misdiagnosed, either through inadequate diagnostic facilities or atypical

clinical presentation. Researchers in Columbia discovered that 27 of the 1596 people (1.7%) on whom postmortems were carried out in Cali, in 1962, had died of rabies, although only one or two cases had been diagnosed annually in years past. Similarly, 21% of all cases in the United States between 1960 to 1979 were not diagnosed until after death, and might have gone undiagnosed if postmortem pathological or virological studies had not been undertaken (Anderson *et al.*, 1984).

Few tropical countries have rabies under control, and the risk of exposure in most developing countries seems appreciable. A survey of missionaries and foreign aid members working in developing countries showed that the overall risk, based on a mean stay of 4–5 years, was 16% per household. Similarly, a survey of 1882 foreign travellers to Thailand, who remained in the country for a mean of 17 days, indicated that 1.3% were bitten by a dog, and that almost 9% were licked by a dog. More extensive analyses in 30 tropical countries show the incidence of rabies to be 0.1–25.8 cases per million population (mean, 3.7), and the number of treatments to be 2.7–4570 (mean, 867) per million population (Bögel and Motschwiller, 1986). However, the incidence of rabies among travellers returning to Europe and North America is very low and it has been estimated that the cost of routine pre-exposure immunization per case prevented per year of stay amounts to Canadian \$275 000. Accordingly, pre-exposure immunization should be offered selectively to travellers deemed to be at the greatest risk.

TRANSMISSION AND PATHOGENESIS

Modes of Infection

Although the commonest mode of infection in humans is by the bite of a rabid animal or the contamination of scratch wounds by virus-laden saliva, other means of infection are possible. Intact skin appears impenetrable to the virus, but infections have been reported following the handling of infected dog carcasses that were being prepared for meals. Infection across undamaged mucous membranes of the mouth, conjunctiva, anus and genitalia, either directly from rabid animals or indirectly through licking contaminated food or material, are recorded. Infection by aerosol transmission has also

been amply demonstrated in laboratory animals, and has been implicated in human infection acquired in bat-infested caverns in Texas and in several laboratory accidents. 'Rage de laboratoire', the consequence of receiving incompletely inactivated fixed rabies virus in human vaccines, is well documented in the older literature and an outbreak involving 18 persons occurred in Brazil in 1960.

Human-to-human transmission by transplantation of infected corneas has been reported in five instances, with the diagnosis in the donors only being made retrospectively. It has also reportedly occurred in an incident involving several young boys in the North-West Frontier Province of Pakistan who were infected by saliva applied to circumcision wounds by a surgeon-barber with early rabies. Occasional cases of human-to-human transmission are described in the older literature, and in a large Indian survey 1 of 11 134 contacts of human cases developed the disease. Judging by the absence of reports of cases in nursing and medical staff, it seems to be a rare event. Nonetheless, medical attendants are at genuine risk of being bitten or contaminated by saliva, and especially to aerosols generated by airway care, and should be considered for postexposure therapy. Kissing and coitus as routes of human-to-human transmission have also been described in the older literature.

Vertical transmission after natural infection is recorded in various species but not in humans, although there are instances of women dying from rabies shortly after parturition. Oral transmission through cannibalism occurs in laboratory animals but has never been described in humans; its role in nature is unknown. Reference to infection in weanling animals, possibly through the consumption of infected milk, was made in a review by Afshar (1979).

Although many patients can relate the circumstances of their exposure, recent experience in the United States indicates that a large proportion are unable to do so.

Pathogenesis

The pathogenesis of rabies involves the entry of virus into peripheral nerves, centripetal movement of virus to the cord and brain, viral replication within the central nervous system (CNS), and centrifugal movement of virus back along nerve routes

to salivary glands and other tissues where viral replication and release occur. The survival of the virus in nature is wholly dependent upon the behavioural changes caused by rabies encephalitis.

Entry Into Peripheral Nerves

Recent reports suggest that the rabies virus receptors on muscular cells coincide with the distribution of acetylcholine receptors. α -Bungarotoxin, a snake venom neurotoxin, also binds to acetylcholine receptors, but the binding of both virus and α -bungarotoxin can be inhibited by monoclonal antibodies raised against residues 190–203 of the rabies virus glycoprotein. However, the virus can enter cells independently of the nicotinic acetylcholine receptor complex (Reagan and Wunner, 1985), but whether this is related to specific receptors is uncertain. For neuronal and fibroblastic cells, it has been found that oligosaccharides, sialic acids and gangliosides may be involved in virus binding. Using sequential tissue titrations, immunofluorescence and electron microscopy, it has been shown that virus localizes initially at motor end-plates near the site of inoculation, infects and replicates in myocytes, is shed into extracellular spaces and involves neuromuscular and neurotendinal spindles to enter peripheral nerves. Only during this early stage does the virus seem susceptible to postexposure therapy.

Translocation to the CNS

The first convincing demonstration that nerve trunks provide the channel for the movement of virus to the brain was provided by Di Vestea and Zagari in 1889. These investigators inoculated *Rabies virus* into sciatic and median nerves and showed that virus was recovered first in the relevant areas of the spinal cord and that its translocation could be interrupted by section of the cord. In 1925, Goodpasture noted that cytopathic changes in the ganglia and CNS corresponded anatomically to the sites of virus inoculation, again inferring neural movement of the virus. Further studies gave support to this hypothesis. *Rabies virus* moves from peripheral sites to the CNS at a rate estimated crudely at 3 mm h^{-1} . Translocation of virus is unaffected by removal of the perineurium, epineurium or perineural epithelium, but can be blocked by local anaesthetics, colchicine and vinblastine. No replication occurs within the axoplasm, which is

devoid of the necessary organelles. However, amplification of virus may occur within neurons of the dorsal route ganglia.

CNS Involvement

From the cord, virus ascent to the brain occurs within 24–48 hours, with initial distribution influenced by the site of inoculation. CSF is of doubtful importance in viral dissemination since in humans it is rarely infectious antemortem. There is extensive viral replication in the brain, which probably supports several growth cycles before onset of clinical effects. The time taken for the virus to spread throughout the brain is roughly half that taken to reach the CNS from the site of inoculation. Terminally, there is widespread CNS involvement in humans and animals, but surprisingly few neurons infected with street virus show structural abnormalities. The nature of the profound neural disorder is thus obscure, although, according to one hypothesis, the greater localization of virus to the limbic system provides a clinicopathological correlate for the abnormal behaviour and aggression necessary for virus perpetuation. Interestingly, recent work suggests that opiate and acetylcholine receptors of infected cells are impaired, implying disordered neurotransmission as the cause for the progressive neural dysfunction.

Movement from the CNS

Following invasion of the CNS, 'street' and occasionally 'fixed' strains of *Rabies virus* move along axoplasmic routes to salivary glands and other tissues. Many sites may be involved, including lacrimal glands, myocardium, skeletal muscle, lung, liver, adrenal glands, the retina, cornea, taste buds, sebaceous glands and hair follicles, particularly those of the head and neck. Sites with short neural connections to the CNS are usually the first to be infected and immunofluorescence of corneal impressions or skin biopsies may establish the diagnosis antemortem.

The most important site for virus transmission is the salivary gland mucosal epithelium which represents the major source of virus shed into secretions. Occasionally the titres of street virus in salivary gland exceed those of brain, indicating efficient replication in mucous acinar cells. Other sites infected commonly, which may shed virus into oronasal

secretions, are the olfactory end-organs in the nares and the neuroepithelium of taste buds. Experimentally, about 48% of dogs, 88% of cats, 42% of foxes and 83% of skunks excrete virus in saliva, though gland involvement of naturally infected animals may reach 90%. The behaviour and appearance of animals are poor guides to their infectivity as reports of preclinical shedding of virus range from 3 days in cats to almost a month in foxes. Moreover, there are well-documented instances of apparently healthy dogs excreting virus intermittently over periods of many months, of apparently healthy animals outliving their victims, and of dogs recovering from rabies. These observations suggest that the practice of discontinuing rabies postexposure treatment if the biting animal is kept under observation and remains healthy for ≥ 5 days is potentially dangerous.

Factors Influencing Infection

Bites inflicted by rabid animals do not necessarily cause disease. In humans, mortality rates of 4–100% have been recorded when the infectivity of the biting animal is established by the death of another person or animal (Table 21.2). Apart from species differences in the susceptibility to the virus, several factors modify the outcome. First, the infectivity of the saliva may vary. Secondly, the virulence of the virus may vary (differences in the amino acid composition of sites II and III of the glycoprotein affect both host range and virulence). Thirdly, the site and severity (deep versus superficial, and multiple versus single) of the bites—severe head and neck bites carry the greatest risk, followed by bites to the upper limb (particularly the richly innervated hand), then the lower limb and trunk. However, the location and severity of wounds are influenced by the species of biting animal, which in turn affects the amount of saliva deposited in the wound and, probably, its infectivity. Finally, the intervention of clothing reduces mortality by 60–80% compared with wounds inflicted through bare skin.

CLINICAL FEATURES

Incubation

The incubation period is highly variable, ranging

Table 21.2 Deaths following bites by rabid dogs and wolves in the absence of rabies postexposure treatment (no account is taken of the position, number and severity of bites)

Reference	Animals species	No. with rabies/ total number exposed
Hunter (1793)	Dog	1/24 (4)
Semple (1919)	Dog	7/9 (78)
Cornwall (1923)	Dog	148/423 (35)
Veeraraghavan (1969)	Mostly dogs	109/195 (56)
Subtotal		265/651 (41)
Shah and Jaswal (1976)	Wolf	1/1 (100)
Gremliza (1953)	Wolf	13/26 (50)
Nikolic (1952)	Wolf	103/169 (61)
Fang-tao <i>et al.</i> (1985)	Wolf	4/4 (100)
Subtotal		121/200 (61)

Values in parentheses are percentages.

from 7 days to several or more years (Figure 21.2), but in most cases it ranges from 30 to 90 days. Exceptionally, in the case of ‘rage de laboratoire’, the incubation period can be as short as 4 days; in the 18 people who died in Brazil after inoculation with vaccine inactivated improperly, the incubation period ranged from 4 to 13 days, with a mean of 8 days. In mice, the greater the infecting dose the shorter the incubation period; similarly in humans there is an association between the incubation period and severity of exposure. The shortest incubations with street *Rabies virus* are seen with multiple severe wounds, especially those involving the head (Table 21.3). Children tend to have shorter incubation periods than adults (Table 21.4), though this may in part be due to them being bitten more severely and frequently on the face. Wolves often inflict multiple deep wounds and rabies following wolf-bites tend to have a short incubation period. Incubation periods are also significantly shorter in patients with ‘failed’ postexposure treatment. Until recently, the only explanation offered was that treatment was relatively more efficient at preventing disease with long rather than short incubation. An alternative hypothesis, which is supported by experimental data, is that an immunopathogenic response may actually accelerate the disease process, causing the ‘early death phenomenon’. This is observed in vaccinated animals with low levels of antibody, who die more rapidly when challenged with *Rabies virus* than unvaccinated control animals without antibody.

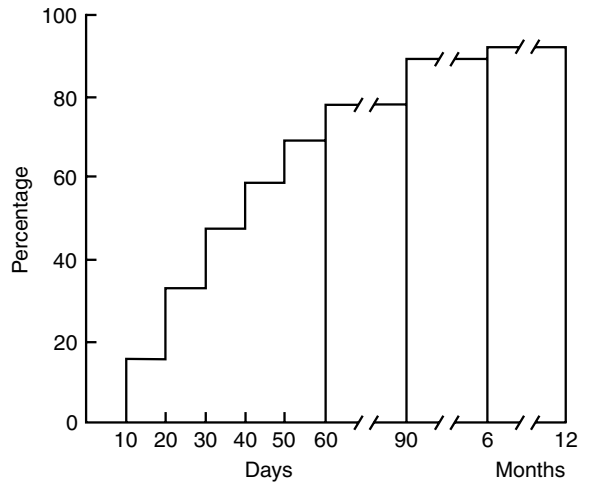

Figure 21.2 Incubation period for cases in Taiwan: the cumulative percentage of cases developing within 12 months of exposure. (Data from Wang, S.P. (1956) Statistical studies of human rabies in Taiwan. *Journal of the Formosan Medical Association*, 55, 548–553)

Table 21.3 Incubation period and location of the bite

Incubation period	Bites to head		Bites to extremities	
	No.	%	No.	%
≤ 1 month	16	67	36	27
> 1 month	8	33	96	73

Data from Wang (1956).

Table 21.4 Incubation period and age

Incubation period	Age < 16		Age ≥ 16	
	No.	%	No.	%
≤ 1 month	42	47	37	26
> 1 month	48	53	108	74

Data from Wang (1956).

Unless secondary infection occurs, any wounds inflicted heal uneventfully during the incubation period. Exactly what happens to the virus throughout this stage is uncertain, although in a mouse model of infection, amputation experiments suggest that the virus may remain at or near the wound site for a prolonged period. Evidence in support of this is provided by experiments in skunks surviving for up to 2 months after intramuscular inoculation with street *Rabies virus*. These revealed the continuing presence of rabies RNA by PCR at the inoculation site.

Clinical Course

The Prodrome

The onset of human rabies is marked by 2–7 days of prodromal symptoms that are almost entirely non-specific, comprising fever, malaise, anorexia, nausea, vomiting, diarrhoea, sore throat, cough, myalgia and headache as the most common complaints. Behaviour disturbances are often noted, including anxiety, depression, stupor, hyperactivity, aggression, delirium and intolerance to tactile, auditory and visual stimuli. The patient may complain of insomnia, nightmares, hallucinations, urinary retention, excessive libido, priapism and rarely recurrent ejaculation. An early symptom of diagnostic significance is of abnormal sensation involving the bitten area, most commonly pain or paraesthesiae, noted in about 45% of cases (Table 21.5). Few objective signs appear early in the clinical course, so unless the doctor's attention is drawn to a recent exposure or healed bite wounds are noticed it is unlikely that the diagnosis will be considered.

Patterns of disease

The prodrome is followed by one of two basic clinical patterns in humans: the more common 'furious' form characterized by hyperexcitability, spasms and hydrophobia; or 'dumb' rabies featuring an ascending paralysis. For descriptive purposes they are considered separately, although 'furious' rabies is often accompanied by paralysis and 'dumb' rabies may herald spasms and hydrophobia. Rabies should therefore be regarded as having a broad clinical spectrum rather than two distinct forms.

The onset of furious rabies is marked by increasing insomnia and periods of extreme agitation, delirium, hyperactivity and purposeless movements, either occurring spontaneously or provoked by any tactile, auditory, visual or olfactory stimuli. Such patients may be mistakenly diagnosed as having schizophrenia, acute mania or delirium tremens. Often these episodes of agitation are accompanied by frothing at the mouth, difficulty in swallowing and intense spasms affecting the muscles of deglutition and accessory muscles of respiration and lasting for 5–15 seconds. They are followed minutes later by lucid intervals with the patient lying anxious and exhausted in bed. The spasms follow characteristically attempts to drink but may be pre-

Table 21.5 Patients in whom pain or paraesthesiae of the bitten area was a presenting feature

Reference	No. with symptoms/total
Dupont and Earle (1965)	23/49 (47)
Suri and Chugh (1975)	19/30 (63)
Wilson <i>et al.</i> (1975)	4/23 (16)
Warrell (1976)	7/20 (35)
Anderson <i>et al.</i> (1984)	19/38 (50)
Total	72/160 (45)

Values in parentheses are percentages.

cipitated by other stimuli, e.g. eating, swallowing accumulated saliva, or by a draught of air (aerophobia). Many patients look intensely frightened, the appearance of fear being heightened by a prototic stare, dilated pupils and an open mouth. Often the respirations are shallow and rapid and there may be chest pain and tightness.

Approximately 50% of human cases exhibit hydrophobia, an overwhelming fear of water precipitated by attempts to drink, and, less frequently, by the sight, sound or mention of water or other fluids. Hydrophobia typically starts with uncontrollable jerking movements of the hand, arm or body as fluid is brought to the mouth; the head jolts backward, the arms upward, fluid is spilled and spasms are induced. Attempts to swallow are defeated by coughing, retching, vomiting, aspiration, opisthotonus, asphyxiation and convulsions, which end in death in 28% of cases. Often the patient struggles violently, may attack attendants or bolt from the room.

The excitement phase sees an initial increase then decrease in the frequency and severity of spasms. The patient is usually febrile and may develop a variety of abnormalities, including nuchal rigidity, photophobia, fasciculations and paresis, particularly at the site of exposure, cerebellar signs, cranial nerve palsies, hypo- or hyperreflexia, extensor plantar responses, focal or generalized convulsions and a variety of autonomic disturbances. Deterioration is marked by the evolution of a flaccid paralysis and onset of coma, by irregular patterns of respiration and by potentially fatal complications. Untreated cases survive for an average of 3–7 days once symptoms develop.

Dumb rabies is far more likely to pose diagnostic problems because the pharyngeal spasms and hydrophobia so characteristic of rabies hardly ever appear. Paralytic rabies has an incidence of 14–60%

in reported series of cases, there being approximately four furious cases for every dumb one overall. The incidence is probably higher, since the onset of a flaccid paralysis some months after a minor or forgotten exposure is likely to be diagnosed as polio, transverse myelitis or Guillain–Barré syndrome. To stress this point, it should be noted that at least five corneas have unwittingly been transplanted from persons with paralytic rabies.

‘Dumb’ or ‘paralytic’ rabies normally begins with typical prodromal symptoms, occasionally with hyperaesthesia or pain localized to the bite site. Anaesthesia may be present, but is seldom a dominant feature. The paralysis often involves the bitten limb initially, then spreads rapidly and symmetrically. Sphincter control is typically lost and paralysis of the muscles of deglutition, articulation and respiration normally occur as a terminal event. The course can be modified at any stage by the appearance of spasms, hydrophobia and convulsions. Survival tends to be longer than for patients with furious rabies, the average period from several series being 7–12 days.

Complications

Complications involving the cardiovascular, respiratory and neurological systems become especially prominent when the course is prolonged by intensive therapy, although disturbances affecting other systems, e.g. renal failure, may also aggravate the clinical course (Table 21.6).

As a sequel to inflammatory or hypoxic cerebral oedema, raised intracranial pressure contributes to the decreased level of consciousness and to focal and generalized convulsions. Other CNS complications include disturbances of thermoregulation, diabetes insipidus, autonomic dysfunction affecting fluid and electrolyte balance and blood pressure, convulsions in two-thirds of cases, and irregular breathing patterns consistent with lesions at the midpontine level or pontomedullary junction.

The clinical course is almost invariably complicated by cardiac dysrhythmias of virtually any kind. Several investigators have noted histological evidence of a myocarditis; ECG changes supporting the diagnosis of myocarditis have also been found and, when searched for, virus has been isolated from myocardium in 52% of cases. Severe hypotension

Table 21.6 Clinical features and complications of human rabies

<i>Nervous system</i>	
	Cerebral oedema
	Convulsions (focal or generalized)
	Hypo- or hyperthermia
	Diabetes insipidus
	Hydrophobia
	Aerophobia
	Irregular respiration
	Hyperactive episodes
	Paralysis
	Anaesthesia/paraesthesia
	Cranial nerve palsies
	Priapism
	Photophobia
	Nuchal rigidity
	EEG abnormalities
	Cerebellar signs
	Inappropriate secretion of antidiuretic hormone
<i>Cardiovascular system</i>	
	Arrhythmias
	Myocarditis
	Hypotension
	Heart failure
	ECG abnormalities
<i>Respiratory system</i>	
	Pulmonary oedema
	Irregular respiration
	Inspiratory spasms
	Bulbar/respiratory paralysis
	Bronchopneumonia
	Respiratory arrest
	Atelectasis
<i>Gastrointestinal system</i>	
	Gastrointestinal tears
	Gastritis
	Ulceration
	Haematemesis
	Pancreatitis
	Ileus
<i>Other</i>	
	Hypovolaemia
	Electrolyte imbalance
	pH abnormalities
	Sialorrhoea and other excessive secretions
	Renal failure

with pulmonary oedema, congestive cardiac failure or acute renal failure is a common finding in the latter stages of the disease and may be partly or wholly caused by myocarditis, hypoxia, autonomic dysfunction or hypovolaemia.

Respiratory disturbances occur in all cases. Blood-gas and pH abnormalities complicate the early clinical course, partly because of hyperventila-

tion. Thereafter death is often precipitated by asphyxiation caused by hydrophobic spasms, convulsions or bulber and respiratory paralysis. Certain complications, notably bronchopneumonia and collapse and consolidation, invariably occur after tracheostomy and artificial ventilation and are potentiated by increased secretions, heart failure and aspiration. Spontaneous pneumomediastinum has also been reported, presumably as a consequence of the inspiratory spasms. The respiratory disturbances together with the cerebral effects on ventilation significantly lower the arterial PO_2 , which is often found as a terminal event.

Hypovolaemia, electrolyte imbalance and pH disturbances, arising from fluid deprivation, inappropriate secretion of antidiuretic hormone, diabetes insipidus, excessive secretions, ileus and ventilation-perfusion defects, frequently complicate the late clinical course. Some gastrointestinal complications are seen occasionally, including gastro-oesophageal tears, frank ulceration, pancreatitis and ileus.

DIAGNOSIS

Differential Diagnosis

With such non-specific prodromal features, rabies is unlikely to be considered during the early stages unless a history of bite exposure is volunteered or obvious spasms or hydrophobia are present. Recent American experience showed rabies to be considered for only 3 of 21 patients on first visit to a physician and for only 7 or 23 on admission to hospital (Anderson, *et al.*, 1984). The admission diagnoses included viral encephalitis, polio, postinfectious encephalitis, vaccine reaction, Guillain-Barré syndrome, brain abscess, cerebrovascular accident, brain tumour, tetanus, phenothiazine toxicity, psychosis, rabies phobia, pneumonia, myocardial infarction, dissecting aortic aneurysm and arteritis. Previous reviews mention 'rage de laboratoire', malingering, delirium tremens, botulism and poisoning by strychnine and other plant derivatives in the differential diagnosis. Important distinguishing features for some of the above are outlined below.

Rabies Phobia

Most patients with rabies phobia or hysteria are

afebrile and prodromal symptoms are absent. They characteristically refuse to drink; if they do drink, they exhibit no jerkiness of hand, arm or head, and no convincing inspiratory spasms. Fanning a patient with genuine rabies often invokes inspiratory spasms, a feature not seen with rabies phobia.

Tetanus

The incubation period is shorter than for rabies, although in many instances it cannot be determined. The presence of trismus and persistence of increased muscular tone between spasms in tetanus normally differentiate it from rabies. The results of lumbar puncture are also helpful, since they are abnormal in 60–90% of cases of rabies (Anderson *et al.*, 1984) but rarely so in tetanus.

Poliomyelitis

Unlike rabies, the fever of polio usually abates with the evolution of paralysis; sensory disturbances, spasms and hydrophobia are also absent.

Vaccine Reactions

Neuroparalytic reactions to neural tissue vaccines are usually seen 8–21 days after the onset of vaccination, well within the incubation period of rabies. Spasms and hydrophobia are absent and recovery is the rule. There is also a notable absence of virus and Negri bodies in the brains of those who die.

Guillain-Barré Syndrome

This cannot be distinguished on clinical grounds or by examination of the cerebrospinal fluid (CSF) during the early stages. Recovery from Guillain-Barré syndrome is generally the rule, however, and consciousness is fully retained. Rabies should always be considered if there is any deviation from the normal clinical course.

Viral Encephalitis

Hydrophobia and spasms are absent in other types of encephalitis and are seen in only one-half of cases with rabies. Since rabies is otherwise indistinguishable from other encephalitides, it should always be considered for patients coming from endemic areas.

Poisoning and Drugs

Strychnine poisoning may cause paroxysmal spasms of respiratory muscles resembling those of rabies, but there are no prodromal symptoms and no fever. Similarly, the dystonia and oculogyric crises of phenothiazine toxicity are unlikely to be confused with the spasms of rabies.

Diagnostic Testing

Non-specific Examinations

The blood white cell count is often elevated (10–20 000 per mm³) with a polymorph predominance; occasionally it is normal or in excess of 30 000 per mm³. CSF examination shows typically a normal opening pressure and a mixed pleocytosis rarely in excess of 300 per mm³ in 60–90% of cases (Anderson *et al.*, 1984). The CSF protein is modestly elevated in one-quarter of cases during the first week of illness. Later it is raised to an average concentration of about 100 mg dl⁻¹ in 80% of cases (Anderson *et al.*, 1984). CT brain scans are reportedly normal, and EEGs usually show diffuse slow-wave activity or an isoelectric recording.

Intravital Diagnosis

Laboratory confirmation of the diagnosis is possible before death by finding specific fluorescence in corneal impressions (obtained by gently abrading the cornea with a microscope slide), skin biopsy (normally taken from the neck or face to show viral antigen in sensory nerve endings) or brain biopsy (rarely indicated); by recovery of *Rabies virus* from saliva, throat swab, tracheal aspirates and exceptionally from tears, urine sediment and CSF; and finally by detecting rabies antibody in serum or CSF. Virus can often be recovered from human saliva, throat swabs or tracheal aspirates during the first 2 weeks of illness, but later attempts at virus isolation or immunofluorescence are often negative (Anderson *et al.*, 1984), presumably because the virus has been 'neutralised' by antibody. CSF rarely contains infectious virus ante mortem, although at autopsy it can occasionally be found. There are no adequately documented cases of viraemia, and attempts to isolate the virus from the blood of human cases have been unsuccessful.

How useful are these methods clinically? Recent American experience showed the detection of serum antibody in unvaccinated subjects to be the most successful overall, with a cumulative detection rate of 50% by days 5–8, 67% by days 9–12 and 100% by days 13–16 (Anderson *et al.*, 1984). Antibody appeared much later in CSF than in blood and was of no help in early diagnosis. As might be expected, antibody detection and virus isolation were inversely related, with virus recovery from 60% on days 0–4, about 32% on days 5–8 and 9–12, and 18% on days 13–16. Similarly, study of seven South American cases showed virus shedding from 100% on days 0–4, 50% on days 5–8, 33% on days 9–12, and from no-one on days 13–16. It should be emphasized that virus isolation is a time-consuming procedure and that it can be one or more weeks into the clinical illness before the diagnosis is established or refuted by either method.

In contrast, immunofluorescence testing, when positive, establishes the diagnosis rapidly, although not all tests yield positive results. In the American series, immunofluorescent staining for rabies antigen in corneal impressions or neck skin biopsy specimens was diagnostic in only about 50% of cases early in the clinical course. In addition, there were instances when the corneal impression test gave false-positive results. In the South American study, daily examination of corneal impressions gave negative results in all seven cases. A PCR with nested primers has been used successfully to diagnose rabies in brain tissue (see following section) and it is highly probable that new molecular techniques will play an important role in *intravital* diagnosis.

Postmortem Diagnosis

The postmortem diagnosis of rabies in both animals and humans for many years depended on the demonstration of Negri bodies in the brain, which appear as intracytoplasmic, eosinophilic inclusions generally measuring 0.2–27 μm in diameter, but may be absent in as many as 30% of cases. They are usually found in more or less undamaged nerve cells, particularly in Ammon's horn, cerebral cortex, medulla and cerebellum. After staining with Seller's methylene blue basic fuchsin, they show a heterogeneous magenta-red matrix containing dark-blue-to-black inclusions known as 'Innerkörperchen'. Structures lacking this inner basophilic core but

otherwise similar to Negri bodies are known as 'Lyssa' bodies. Both structures contain rabies antigen and are found in great numbers in rabid brain, but neither is pathognomonic for rabies.

Intracerebral mouse inoculation with a homogenate of brain coupled with immunofluorescence is an extremely valuable confirmatory test, although if the patient's survival is prolonged until after the appearance of antibody, attempts at virus isolation almost invariably yield negative results. NA C1300 murine neuroblastoma cells are the most susceptible of cell lines for street *Rabies virus* and are at least as efficient, and possibly more so than the mouse inoculation test. Moreover *in vitro*-based culture techniques reduce the overall time required from several weeks to several days. Although no cytopathic effects are observed, rabies antigen can be detected by immunofluorescence (IF).

Demonstrating rabies antigen in sections of human brain by IF is probably the most rapid specific test, but again it is often negative in cases with prolonged survival and requires the material for examination to be in a good non-putrefied state. However, IF can still be carried out if the specimen has been fixed in formalin. An antigen detection ELISA, known as the rapid rabies enzyme immunodiagnosis (RREID), has been used successfully to detect rabies nucleocapsid in homogenized brain suspensions that have not been fixed in formalin. The minimum amount of nucleocapsid detectable by RREID is $\sim 1 \text{ ng ml}^{-1}$ and a naked-eye reading is sufficient to confirm the diagnosis, thereby obviating the need for sophisticated or expensive equipment such as a photometer or IF microscope. Further increases in sensitivity are possible using antirabies nucleocapsid globulin conjugated to biotin, and peroxidase-conjugated streptavidin.

Dot hybridization with ^{32}P -radiolabelled probes has also been used for rabies diagnosis but detects rabies genome only in heavily infected samples. More recently, a nested PCR has been described (Kamolvarin *et al.*, 1993) which is capable of detecting as little as 8 pg of rabies virus RNA. The PCR was able to confirm rabies infection in decomposing specimens, left for 48 hours at room temperature, that were negative by IF. The whole procedure, including reverse transcription, cDNA synthesis and DNA amplification, was accomplished within 24 hours and will undoubtedly be of value in major diagnostic centres. Finally, electron microscopy can establish the diagnosis by revealing the presence of

typical bullet-shaped virus particles in postmortem brain. In addition to nervous tissue, rabies virus can be identified in a variable proportion of cases in the lacrimal and salivary glands, myocardium, skeletal muscle, lung, liver, kidney, peripheral nerves and adrenal glands.

Once virus has been recovered, antinucleocapsid monoclonal antibodies provided by WHO can be used to distinguish between viruses belonging to Lyssa serotype 1 (positive with monoclonal antibody C-15, negative with antibody 422) and viruses belonging to the other serotypes (negative with C-15 and positive with 422). Nucleocapsid monoclonals also permit the identification of the geographic origin or the species origin of the virus. Glycoprotein monoclonals are of less value in this respect due to the high variability of the GF epitopes of field isolates.

MANAGEMENT

In contrast to most viral encephalitides there is a relative lack of cytolysis and inflammation. The changes noted are perivascular cuffing, neurophagia and neural degeneration, and proliferation of the capsular cells surrounding ganglionic neurons and Negri bodies. This inevitably fired speculation that intensive supportive care might eventually lead to recovery. The survival of two patients with proven rabies for periods of 64 and 133 days, together with the recovery of three patients with probable rabies, has raised further hopes, although one survivor was left with severe neurological impairment and all three were vaccinated prior to the onset of symptoms. Life can undoubtedly be prolonged by meticulous supportive care, although it is equally clear from recent experience that it is the extent and severity of the encephalitis that are major barriers to survival.

Many patients have been given the benefit of treatment with antiviral agents or immunotherapy, but the measures tried have all been singularly unhelpful. Steroids impair antibody production and depress immunity in laboratory animals and have been used without success in humans and are generally contraindicated. No benefit has been gained from cytosine arabinoside, ribavirin, inosine prabonex, or administration of rabies antibody either by the intrathecal or intramuscular routes, or

from transfusion of a unit of immune whole blood. In fact, the discovery of 'lytic' antibody led to the view that passively administered antibody after onset of disease might actually be harmful. Exchange transfusion was therefore tried; this too was unhelpful. Similar lack of success was noted with Freund's adjuvant and a polyanion interferon inducer. Interferon itself has been tried in several patients by intramuscular and intrathecal routes; none survived and interestingly the virus could still be isolated from one patient 5 days after onset of treatment.

PREVENTION

Postexposure Prophylaxis

The essential components of postexposure prophylaxis are the local treatment of wounds and active and passive immunization. The potency of cell culture vaccines is determined by the NIH (National Institutes of Health) test and is expressed in international units (iu) per millilitre. To satisfy the WHO requirements for human rabies vaccine, all cell culture vaccines should have a minimum potency of 2.5 iu per dose. Interferon and interferon inducers have yet to be evaluated in humans, though they are of proven value in laboratory animals.

Wound Treatment

Experimentally, the incidence of rabies can be reduced markedly by local therapy alone. It is of maximal value when applied promptly after exposure but should not be neglected even if several hours or days have elapsed. Recommended first-aid procedures are the thorough cleansing of the wound for several minutes with copious amounts of soap and water, detergent, or water alone; the application of a virucidal substance, either 40–70% alcohol, tincture or aqueous solutions of iodine, or a quaternary ammonium compound (QAC), e.g. 1–2% benzalkonium chloride, 0.1% cetrimonium bromide (Cetavlon); passive immunization; and antitetanus procedures and antibiotics when indicated. Puncture wounds should be probed gently with an appropriate disinfectant, taking care not to cause further trauma. Wound toilet is possibly the single most important procedure for preventing infection. QAC may be neutralized by tap water in

hard-water areas, as well as by soap. Wounds cleansed with a soap solution should be thoroughly rinsed with water before application of one of the chemical disinfectants. Gaping bite wounds should not be immediately sutured; if suturing is necessary then antiserum or immune globulin should be infiltrated locally as stated below, and suturing should be delayed for as long as possible, up to 3 days.

Passive Immunization

Human treatment with antiserum began in 1891, but it was not until 1954, when 29 Iranian villagers were bitten by a rabid wolf and the mortality of vaccine-only and vaccine-plus-antiserum groups were compared, that the value of passively administered antibody was shown convincingly. In 1957, the WHO Expert Committee on Rabies recognized the importance of prompt infiltration of wounds with antiserum and recommended its use. Selimov *et al.* (1959), Fathi *et al.*, (1970) and Fang-tao *et al.* (1985) have provided further evidence for the beneficial effect of antiserum following bites by rabid animals, mostly wolves. Aggregated data from Iran, Russia and China indicate that antiserum saves the lives of approximately 85% of persons who would otherwise develop rabies and die, despite treatment with neurotissue vaccine (NTV). The beneficial effect of combined active and passive immunization is generally not in doubt, but there is now abundant evidence that passively administered antibody alone serves only to prolong the incubation period and provides little, or no, protection.

WHO strongly recommends the use of heterologous antirabies immune globulin, e.g. equine immune globulin (ERIG) or human rabies immune globulin (HRIG), for therapy of severe exposure, i.e. licks of mucosa, multiple bites, or bites involving the face, head, fingers or neck by a known rabid animal, or following an unprovoked attack by an animal in an endemic area unless proved negative by laboratory examination. It also considers that its use may be justified in some minor exposures, especially when the skin has been deeply punctured. It is customary in western Europe and North America to administer HRIG following bites by all rabid and suspected rabid animals.

When employed, HRIG or ERIG is administered only once at the beginning of antirabies prophylaxis to provide antibodies during the early critical period before development of active immunity. The

recommended dose of HRIG is 20 iu kg^{-1} of body weight and 40 iu kg^{-1} for ERIG. The immune globulin should be infiltrated into and around the wound and any remaining immune globulin should be injected intramuscularly at a site distant from the site of vaccine inoculation. ERIG is considerably less costly than HRIG. Most of the preparations of ERIG available cunningly are highly purified, pepsin-digested products and safe; however, serum sickness may develop in up to 6% of patients 7–10 days later. WHO advises that a skin test should be carried out prior to its use. Although this may detect rare cases of IgE-mediated hypersensitivity reactions to equine antiserum most reactions result from complement activation and are not predicted by skin testing. Although HRIG or ERIG should be given concurrently with the first dose of rabies vaccine, immune globulin preparations are not always available in the field. In this situation immune globulin can be administered up to 5 days after multisite postexposure immunization without significant depression of the active antibody response, and may still provide antibodies before development of active immunity.

Neurotissue Vaccines

The infected brain tissue of adult rabbits, sheep and goats remains an important source of virus for vaccine production in some areas of the world. The most widely used is the Semple type of vaccine, which is completely inactivated with phenol. Due to poor antigenicity, courses of treatment consist of up to 24 5-ml injections of a 5 or 10% brain suspension, equivalent to 6–12 g of brain tissue. NTV usage has long been associated with an unacceptably high incidence of postvaccinal reactions, including inflammation, malaise and paralysis which develops 4–21 days after initiating therapy. Rates of neurological reactions associated with the use of adult brain tissue vaccines vary greatly, with an overall rate of around 1 per 1100. The case-fatality rate among these patients is about 10%. The encephalitogenic antigen has been identified in studies of experimental allergic encephalomyelitis as myelin basic protein. Reports on the efficacy of NTV after bites by animals causing rabies in untreated people indicate protection rates ranging from 0 to 87%. In two reports, treatment of bites by rabid dogs in Thailand ($n = 77$) and Dehli ($n = 75$) with NTV, with and without antirabies serum, was asso-

ciated with complete protection.

The 'unmyelinated' neural tissues of newborn mammals, frogs and fish are considered free from the encephalitogenic factor, and in 1955 Fuenzalida and Palacios prepared a vaccine from the brains of suckling mice (SMBV). SMBV, inactivated by UV light, β -propiolactone or phenol, is used extensively in South America and is easily and cheaply produced. However, myelin is present in preparations of brain from mice aged 9 days and, unfortunately, reports of neuroallergic reactions to SMBV have accumulated since 1967. Although the incidence of these reactions is approximately fivefold lower than with conventional brain tissue vaccines, the case-fatality rate is higher, making SMBV only marginally safer overall. SMBV is now prepared using mice no older than 1 day at the time of inoculation. Attempts were made to purify SMBV by centrifugation and chromatography, but events in the field of tissue culture vaccine have overshadowed these developments.

Duck Embryo Vaccine

In countries like the United States and Britain, vaccines prepared from fixed strains of *Rabies virus* grown in duck embryos became available commercially during the late 1950s and early 1960s. Although far safer than NTVs, the high content of avian protein in duck embryo vaccine (DEV) often gave rise to troublesome local reactions and anaphylaxis and to neurological accidents occurring with an estimated incidence of 1 in 32 600 and fatality rate of 1 in 210 000. DEV was also poorly antigenic but, despite shortcomings, it remained the only vaccine available in Britain and the United States until licensure of human diploid cell vaccine (HDCV). Subsequently DEV was withdrawn from the market by its American manufacturers but a highly purified DEV (PDEV) is produced in Switzerland. PDEV contains only about 1% of the protein of previous DEV. Potency testing of consecutive batches has consistently shown antigenic values in excess of 5 iu ml^{-1} and substantial antibody responses are evoked in humans. Mild local reactions occur only slightly more frequently than with HDCV.

Human Diploid Cell Vaccine

Strides made in the field of cell culture techniques

and virus purification opened an entirely new approach for the preparation of rabies vaccines. From the early 1970s to the mid-1980s most attention focused on HDCV developed in WI-38 human diploid cells which were isolated from human embryonic lung. The virus used was the Pitman Moore strain of fixed *Rabies virus*. HDCV is now prepared using MRC-5 cells. Virus yields are concentrated by ultrafiltration, or concentrated and purified by rate-zonal centrifugation in sucrose gradient, and inactivated by β -propiolactone.

Early trials in volunteers established rapidly that HDCV was infinitely superior to neural and avian preparations. Not only were antibody levels far higher than with other vaccines, but it appeared earlier and in practically 100% of subjects with many fewer doses and with only mild local reactions. In 1976, trials in Germany and Iran showed HDCV together with serum or HRIG to afford complete protection to persons bitten by known rabid animals. The vaccination schedule consisted of six doses given on days 0, 3, 7, 14, 28 and 90; this regimen is now officially recommended by WHO, though in some countries the day 90 dose has been dropped. More than 10 million doses had been used to treat an estimated 2 million patients worldwide by December 1994.

The principal disadvantage of HDCV is its expense compared with other cell culture vaccines, which is partly related to the difficulty in handling diploid cells, and the need to concentrate virus harvests 10–20-fold to achieve vaccines of adequate potency. None the less, more than 10 million doses had been used to treat several million people worldwide by December 1994. Accordingly, vaccine manufacturers have explored new cell substrates, culture systems, vaccine strains and technologies in order to reduce costs and equal the high standards of potency and efficacy of HDCV.

Other Cell Culture Systems

In Germany, exploitation of primary chick embryo cells and the Flury LEO-C 25 strain of rabies virus has led to the development of primary chick embryo cell culture vaccine (PCECV). PCECV is highly immunogenic, evoking antibody responses comparable to those produced by HDCV, and is no more reactogenic. PCECV is licensed for postexposure use and over 2 million doses have been used for postexposure treatment in Africa, Europe, the In-

dian subcontinent and south-east Asia (Thailand).

Purified Vero cell rabies vaccine (PVRV) is prepared using Vero cells grown on a microcarrier system and infected with the same Pitman Moore strain of fixed *Rabies virus* used for HDCV production (Montagnon *et al.*, 1985). The use of such a heteroploid cell substrate for producing human vaccines was excluded until recently because it was thought that potentially oncogenic DNA might be released from the cells during viral replication. However, provided that appropriate tumorigenicity tests are carried out and the product is free from cellular DNA, continuous cell lines are now accepted widely for human vaccine production. Inactivated polio vaccine was the first vaccine made using this cell substrate. PVRV satisfies the stringent safety requirements and has shown excellent antigenicity in humans, again with antibody responses comparable to those of HDCV. Use of the microcarrier technique and the greater yield of virus from Vero cells compared to human diploid cells has resulted in a considerable reduction in price. The vaccine is purified by zonal centrifugation and chromatography and is well tolerated. Approximately 11 million doses of PVRV had been used worldwide by December 1994.

In the former USSR, a UV light-inactivated vaccine has been prepared from primary hamster kidney cells (PHKCs) infected with the Vnukovo-32 strain of *Rabies virus*. A PHKC vaccine has also been prepared using the Beijing strain of fixed *Rabies virus* inactivated with formaldehyde. Approximately 50 million doses have been produced, principally for postexposure use. Fetal rhesus monkey diploid cell vaccine was developed in the United States and has been licensed there for both pre- and postexposure treatment. Vaccines have also been prepared using cultures of fetal bovine kidney cells and dog kidney cells.

Efficacy

Between 1980 and 1982, 511 patients in the United States were bitten by rabid animals and survived after treatment with five doses of HDCV and HRIG. The vaccine has also been reported to be effective in hundreds of other patients bitten by rabid animals. Postexposure treatment trials of other cell culture vaccines that satisfy the WHO minimum potency requirements have yielded the same results. The efficacy of PCECV was tested in

69 patients who had been bitten by rabid animals in Thailand; 32 patients also received HRIG. None of the patients developed rabies. Similarly, no cases developed among 47 patients who were treated with PCECV and HRIG in Yugoslavia, most of whom had only mild exposure to rabies. Japanese PCECV was tested in 52 severely rabies exposed patients in Thailand without treatment failures; all patients received ERIG in addition. Fetal bovine kidney cell vaccine was used successfully for the postexposure treatment of 153 patients who had been exposed to animals with rabies, nine of whom suffered major bites. The efficacy of PVRV was similarly tested in 106 patients who were bitten by rabid animals; 47 patients had severe exposures and were also treated with HRIG. The vaccine has also been used successfully in at least 500 other cases.

Although the commercially available cell culture vaccines are equally immunogenic and effective when given postexposure, the newer vaccines (PCECV and PVRV) and PDEV are still too expensive (\$US50–60 for a 5 or 6 dose course) for widespread use in underprivileged countries. Accordingly the intradermal route of vaccination has been explored as a means of reducing the costs still further.

Multisite Intradermal Vaccination

There is convincing evidence that economical intradermal schedules of immunization with potent tissue culture vaccines are as effective as the more costly intramuscular schedule. The pioneering experiments and field trials using the intradermal route involved multisite inoculations with an initial eight intradermal injections (see below). After initial reservations concerning difficulties in giving good intradermal injections, this route has gained widespread acceptance and two-site and eight-site intradermal schedules are now recommended by WHO for postexposure treatment.

The eight-site intradermal method involves doses of 0.1 ml, where the intramuscular dose is 1 ml after reconstitution. On day 0, 0.1 ml is given at each of eight sites over the deltoid, lateral thigh, supra-scupular region and lower quadrant of the abdomen. On day 7, 0.1 ml is given at each of four sites over the deltoids and thighs, and on days 28 and 90 one intradermal dose is given at one site over the deltoid. The eight site schedule was tested in 78 patients with proven rabies exposure, and 36 of these, with severe exposure, also had rabies immune

globulin. No deaths from rabies occurred during the 2 years of follow-up.

The two-site intradermal method involves doses of either 0.1 ml or 0.2 ml (according to vaccine type), where one intradermal dose is one-fifth of an intramuscular dose. On days 0, 3 and 7, one intradermal dose (either 0.1 ml or 0.2 ml according to vaccine type) is given at each of two sites over each deltoid. On days 28 and 90, one intradermal dose is given at one site on the upper arm. The two-site regimen was tested with PVRV in 100 patients with proven exposure to rabid animals. All patients were also treated with rabies immune globulin and were followed up for 1 year. No cases of rabies occurred. This regimen has been used to treat more than 82 000 patients in Thailand and the Philippines.

Both regimens lower considerably the cost of vaccination against rabies, as the total volume of vaccine is much less than that required for the intramuscular regimen. However, intradermal injections should only be given by staff who have been trained in the technique. The application of cell culture vaccines by multisite intradermal vaccination reduces the cost of treatment to ~ \$US16–20, which is still twice as much as SMBV. However, it must not be forgotten that the use of brain tissue vaccines necessitates many more injections, which has substantial cost implications, and that NTVs cause unacceptable reactions. Moreover, NTV is generally acknowledged to be less effective than the potent tissue culture vaccines, which also has cost implications. Overall there is probably little difference in cost between NTV and the abbreviated regimens for the newer tissue culture vaccines.

Safety of Cell Culture Vaccines

HDCV and other commercially available cell culture vaccines are well tolerated. The frequency with which minor adverse reactions have been reported varies from report to report, primarily because of differences in the methods used to collect information. However, comparative studies have shown that there are no significant differences between HDCV, PCECV and PVRV in terms of minor local adverse reactions and systemic side-effects. Local pain can be expected after about one-fifth of intramuscular injections with rabies cell culture vaccines. It is usually mild and generally subsides within 2–3 days. Local erythema, swelling and pruritus occur infrequently (0–5%) after intramuscular in-

jections, but local erythema and swelling can be expected after 50–75% and 20–30% of intradermal injections, respectively. Occasional systemic reactions are noted after both intramuscular and intradermal injections; the most common are malaise, generalized aches and headaches, which are recorded by 1–5% of vaccinees. Studies of pregnant women have revealed an adverse reaction rate similar to that of non-pregnant women who received the same tissue culture-derived rabies vaccines; treatment should therefore not be withheld when an indication exists.

Between May 1980 and April 1984, over a period of 48 months, 108 allergic reactions to HDCV (11 per 10 000 vaccinees) were reported in the United States. Reactions ranged from urticaria to anaphylaxis and mostly occurred in association with boosters. No significant associations were demonstrated between persons who reported presumed type III hypersensitivity reactions and age, route of immunization (i.m. or i.d.), timing of booster after primary immunization, history of other allergies, or history of previous immunization with rabies vaccines other than HDCV. These reports of systemic allergic reactions included nine cases of presumed type I hypersensitivity (1:10 000), 87 cases of presumed type III delayed hypersensitivity (9:10 000) and 12 cases of indeterminate type of allergic reactions. Few patients required hospitalization and there were no fatalities. Skin testing of five persons experiencing the reaction showed that all reacted strongly to the Merieux HDCV, but only one showed any reactivity to the more purified vaccine from the Behring Institute, and that was very weak. Radioallergosorbent tests (RASTs) on sera from four patients who had also experienced allergic reactions showed that they all reacted positively to the Merieux HDCV and to β -propiolactone-treated human serum albumin, but not to HDCV not inactivated by β -propiolactone, to DEV inactivated by β -propiolactone, or to human serum albumin. It was subsequently shown that administration of homologous serum albumin treated with β -propiolactone caused anaphylaxis in 70% of guinea-pigs, and this led to the conclusion that the reactions were caused by the β -propiolactone-treated human serum albumin component of the vaccine.

In contrast to the high incidence of neuro-paralytic reactions to conventional vaccines, the rate of neurological side-effects with HDCV and

other cell culture vaccines is extremely low. By June 1990, six cases of neurological reactions associated with the use of HDCV had been reported. In five cases weakness or paresthesia were transient, though one patient suffered residual wasting of the deltoid muscle. The sixth patient developed a relapsing neurological illness which resembled multiple sclerosis. Even if all six cases were caused by vaccination with HDCV, the rate of neurological complications is estimated at about 1 per 500 000 patients, similar to that for vaccines such as oral poliomyelitis. One case of peripheral neuropathy was reported in association with fetal bovine kidney vaccine.

Postexposure Treatment Failures

By June 1988, 17 people had developed rabies after treatment with HDCV, PCECV or PVRV. A further 12 deaths were reported between 1988 and 1991. Review of the first 17 deaths at an informal WHO meeting revealed that 13 had severe exposure, i.e. licks on mucosal surfaces or 'major' bites, namely multiple bites, or bites to the face, head, fingers or neck. At least 11 of these 13 patients had not received passive immunization as recommended by WHO, and only one definitely received immune globulin around the wound as advised by WHO. Treatment had also been delayed in most cases. After careful analysis by the expert group, it was agreed that only one could definitely be considered a treatment failure. In all other cases (with the possible exception of an Iranian case in whom the site of passive immunization was unknown and in whom the extent and severity of the facial wounds would have posed considerable difficulties with respect to effective wound infiltration) treatment flaws were noted, mostly the lack of antiserum, the failure to infiltrate antiserum locally, and delays in treatment. Similarly, 31 case of rabies had been reported in spite of postexposure treatment with the Vnukovo-32 PHKC vaccine or the Chinese PHKC vaccine. Most, if not all, of these cases were associated with delayed or inadequate therapy and should not be considered as treatment failures. The circumstances surrounding five failures of postexposure treatment of rabies in five small children have recently been discussed (Wilde *et al.*, 1996). All had multiple severe bites on the face and head and all had received rabies immune globulin and a potent tissue culture vaccine. How-

ever, surgical closure prior to wound infiltration with immune globulin occurred in three cases, and another had wounds sutured after an intramuscular injection of immune globulin, without wound infiltration.

Pre-exposure Prophylaxis

The safety and potency of rabies vaccines of cell culture origin allow persons who are regularly at high risk of exposure, such as veterinarians, laboratory workers, animal handlers and wildlife officers, to be protected by pre-exposure immunization. It should also be considered for persons, especially children, living in or visiting countries where rabies is a constant threat and where postexposure treatment with potent vaccines is not readily available.

Potent cell or avian culture vaccines (HDCV, PCECV, PVRV or PDEV) are the vaccines of choice. Immunization should preferably consist of three intramuscular doses of vaccine of potency of at least 2.5 iu given on days 0, 7 and 28 (or on days 0, 28 and 56; a few days' variation is unimportant). The intradermal application of 0.1 ml volumes may be used in place of the 1.0 ml volumes normally given intramuscularly. Antibody can be demonstrated in the sera of virtually 100% of subjects after three doses of potent cell culture vaccines and it is unnecessary to monitor the immune response except in high-risk situations. In such people serum samples should be collected 1–3 weeks after the last dose and, if the titres are not equivalent to 0.5 iu ml^{-1} or greater, boosters should be administered until neutralizing antibody becomes demonstrable.

Booster doses should be offered to persons at continuing risk every 1–3 years or whenever necessary, as determined by antibody titration. In view of the allergic reactions recently described after HDCV boosters (see above), efforts should be made to avoid unnecessary boosters.

Local treatment of wound should always be carried out in exposed persons who have been vaccinated previously. Persons vaccinated previously who have had full pre- or postexposure treatment with cell culture or purified DEV, or who have had a rabies neutralizing antibody titre of $> 0.5 \text{ iu ml}^{-1}$ in the past, should be given only two booster doses, one immediately and one 3 days later. Persons who

have received previously pre- or postexposure treatment with vaccines of unproven potency, and those who have not demonstrated an acceptable neutralizing antibody titre (i.e. $\geq 0.5 \text{ ml}^{-1}$), should receive a complete postexposure course, including rabies immune globulin if indicated.

Assessing Immunity to Rabies

The mouse neutralization test (MNT) provides a useful diagnostic tool and an important method of assessing vaccines but it requires large numbers of young adult mice and the facilities necessary to contain them, and is expensive and dangerous for laboratory staff, who may accidentally inoculate themselves with challenge virus. The test also suffers with an inherent variability making it difficult to correlate results between laboratories, even when standard antiserum is included in each test. Moreover, the MNT has the disadvantage of requiring at least 14 days for completion.

To overcome these problems a number of attempts have been made to develop an *in vitro* assay for virus neutralizing antibody. A cytopathic effect with *Rabies virus*, although reported by some authors, has not been sufficiently reliable to permit routine tissue culture neutralization tests such as inhibition of cytopathic effect or plaque inhibition. However, immunofluorescent staining techniques led to the rapid fluorescent focus inhibition test (RFFIT), in which foci of virus-infected cells are observed by fluorescent antibody staining. The test requires only 24 hours for completion and is more reliable and reproducible than a neutralization test in mice. However, it still requires the use of cell culture techniques and equipment and live virus.

The complement fixation test, the haemagglutination inhibition test and the mixed haemadsorption test have gained only limited acceptance for determination of rabies antibody, and radioimmunoassay is expensive, carries some risks and, because it requires expensive equipment, is restricted to central facilities.

Enzyme-linked immunosorbent assay (ELISA) provides a rapid, simple test for the measurement of rabies antibodies and there is good agreement between the results of neutralization tests and ELISA, especially if a rabies glycoprotein preparation is used as antigen instead of purified inactivated ra-

bies vaccines of cell culture origin. If a reference serum is included in the test the results can be expressed in equivalent units (eu ml⁻¹). The ELISA test also has the advantage of allowing separate titration of IgG and IgM antibodies. ELISA is simple and quick to perform, with results being available in a few hours; however, it requires highly purified antigen. A competitive ELISA for the detection of rabies virus neutralizing antibodies employs a rabies neutralizing monoclonal antibody conjugated to an enzyme and is not dependent on highly purified antigen.

Antibody and Protection

Virus neutralizing antibody has long been considered to be the key to successful rabies prophylaxis, both before and after virus exposure, and inadequate antibody responses to neurovaccine and DEV have generally been held responsible for occasional treatment failures. Review of the literature in which pre-exposure immunization of various animal species was followed by peripheral challenge with street *rabies virus* reveals a 96% reduction in mortality when antibody was present at the time of challenge. In the absence of antibody, survival was 57.5% if a humoral response had been demonstrated previously, and 23.6% if it had not. Inspection of the antibody titres of the 14 animals that died revealed a range of 1:2 to 1:1750 (GMT 1:18), implying that even substantial titres of antibody do not always guarantee protection. Two recent studies in preimmunized dogs and cats have shown a relation between the titre of neutralizing antibody and protection against rabies virus challenge: a neutralizing antibody titre of approximately 0.5 iu ml⁻¹ at the time of challenge is necessary for uniform protection, and this titre is accepted by WHO as indicating a satisfactory response to vaccination.

The association between antibody and protection is much less clear for treatment given after exposure. Indeed, there is evidence to suggest that the humoral response to rabies has a dual role—mostly favouring protection, but sometimes promoting the disease through immune cytolysis effected through antibody and complement, or by antibody-dependent cytotoxicity or antibody enhancement of viral replication. In several studies in monkeys, in which challenge with street virus was followed by a single injection of potent rabies vaccine of tissue

culture origin, animals that succumbed to infection showed high-titred antibody responses, comparable in height and time of appearance to those of survivors. Several studies have shown that the antibody profiles of patients dying after NTV treatment were equivalent to those of survivors. Since postexposure administration of passively administered antibody generally prolongs survival but has little influence on mortality in laboratory animals, it is evident that other limbs of the immune system have key roles in postexposure treatment.

Cell-mediated Immunity

The contribution of cell-mediated immunity to protection afforded by postexposure immunization is as inconclusive as that of antibody. In approximately 80% of subjects immunized with potent tissue culture vaccines, lymphocyte transformation occurs and is a T cell response. Antibody-dependent cell-mediated cytotoxicity (K cell lysis) has also been demonstrated with sera and lymphocytes from humans receiving HDCV. Similarly, skin testing and the inhibition of peripheral blood leucocyte migration have demonstrated cell-mediated immune responses in volunteers immunized with SMBV. Numerous data in experimental animals are recorded, though few results suggest that cell-mediated immunity rather than antibody is concerned with protection.

Experimentally, T lymphocytes, specifically cytotoxic for rabies-infected target cells, can be generated in vaccinated mice and rabbits, and in the former species it was, under certain circumstances, related to protection. Interestingly, cell-mediated cytotoxicity was not generated in mice infected with virulent street *Rabies virus*, suggesting that in natural infection *Rabies virus* has an immunosuppressive effect. Support for this hypothesis has also been provided by various studies, including delayed-type hypersensitivity reactions measured in mice by footpad swelling, and by *in vitro* studies of cytokine production by cells from rabies-infected mice. Moreover, study of seven proven cases of rabies (four furious and three paralytic) showed that natural killer cells were diminished in almost all cases and B lymphocytes were decreased in those with paralytic disease compared to those with encephalitis. Lymphocyte proliferation tests to rabies antigen on peripheral blood lymphocytes from nine patients with the encephalitic form of rabies, and on

seven with the paralytic form, showed that six of the nine patients with encephalitis had proliferative responses, whereas all of those with the paralytic form had no response.

Until recently, most experimental attention concerning the protective immunity focused on the role of the G protein, which induces neutralizing antibody. Purified rabies virus nucleoprotein has recently been found to provide resistance to lethal challenge with both homologous and heterologous virus strains and to evoke a strong T helper cell response. This may provide an explanation for the protection afforded by some NTVs, which are poor in terms of neutralizing antibody induction, but none the less evoke high titres of antibody as measured by ELISA.

REFERENCES

- Afshar, A. (1979) A review of non-bite transmission of rabies virus infection. *British Veterinary Journal*, **135**, 142–148.
- Anderson, L.J., Nicholson, K.G., Tauxe, R.V. *et al.* (1984) Human rabies in the United States, 1960 to 1979: epidemiology, diagnosis, and prevention. *Annals of Internal Medicine*, **100**, 728–735.
- Benmansour, A., Brahimi, M., Tuffereau, C. *et al.* (1992) Rapid sequence evolution of street rabies glycoprotein is related to the highly heterogeneous nature of the viral population. *Virology*, **187**, 33–45.
- Bögel, K. and Motschwiller, E. (1986) Incidence of rabies and postexposure treatment in developing countries. *Bulletin of the World Health Organization*, **64**, 883–887.
- Cornwall, J.W. (1923) Statistics of antirabic inoculations in India. *BMJ*, **2**, 298.
- Dupont, J.R. and Earle, K.M. (1965) Human rabies encephalitis. A study of forty-nine fatal cases with a review of the literature. *Neurology*, **15**, 1023–1034.
- Fang-tao, L., Xiao-Zengl, L., Shu-beng, C. *et al.* (1985) Further study on the stability and efficacy of the primary hamster kidney cell rabies vaccine. In *Improvements in Rabies Post-exposure Treatment* (eds I. Vodopija, K.G. Nicholson, S. Smerdel *et al.*), pp 37–45. Institute of Public Health, Zagreb.
- Fathi, M., Sabeti, A. and Bahmanyar, M. (1970) Séroprophylaxie antirabique chez les sujets mordus par loups enragés en Iran. *Acta Medica Iranica*, **13**, 5–9.
- Gaudin, Y., Ruigrok, R.W.H., Tuffereau, C. *et al.* (1992) Rabies virus glycoprotein is a trimer. *Virology*, **187**, 627–632.
- Gaudin, Y., Ruigrok, R.W.H., Knossow, M. *et al.* (1993) Low-pH conformational changes of rabies virus glycoprotein and their role in membrane fusion. *Journal of Virology*, **67**, 1365–1372.
- Gremliza, L. (1953) Kasuistik zum Lyssa-problem. *Zeitschrift für Tropenmedizin und Parasitologie*, **4**, 382–389.
- Hunter, J. (1793) Observations, and heads of enquiry, on canine madness, drawn from the cases and materials collected by the society, respecting that disease. *Transactions of the Society for the Improvement of Medical and Chirurgical Knowledge*, **1**, 294–329.
- Kamolvarin, N., Tirawatnpong, T., Rattanaswamoke, R. *et al.* (1993) Diagnosis of rabies by polymerase chain reaction with nested primers. *Journal of Infectious Diseases*, **167**, 207–210.
- Kucera, P., Dolivo, M., Coulon, P. *et al.* (1985) Pathways of the early propagation of virulent and avirulent rabies strains from eye to the brain. *Journal of Virology*, **55**, 158–162.
- Montagnon, B.J., Fournier, P. and Vincent-Falquet, J.C. (1985) Un nouveau vaccin antirabique a usage humain: rapport préliminaire. In *Rabies in the Tropics* (eds E. Kuwert, C. Mereieux, H. Koprowski *et al.*), pp 138–141. Springer-Verlag, Berlin.
- Nikolic, M. (1952) Die Ergebnisse der Tollwutschutzimpfung beim Menschen nach Wolfverletzung. *Zeitschrift für Tropenmedizin und Parasitologie*, **3**, 283–296.
- Préhaud, C., Coulon, P., Lafay, C. *et al.* (1988) Antigenic site II of the rabies virus glycoprotein; structure and role in viral virulence. *Journal of Virology*, **62**, 1–7.
- Préhaud, C., Nel, K. and Bishop, D.H.L. (1992) Baculovirus-expressed rabies M1 protein is not phosphorylated: it forms multiple complexes with rabies N protein. *Virology*, **189**, 766–770.
- Ragan, K.J. and Wunner, W.H. (1985) Rabies virus interaction with various cell lines is independent of the acetylcholine receptor. *Archives of Virology*, **84**, 277–282.
- Selimov, A., Boltucij, L., Semenova, E. *et al.* (1959) Anwendung des Antirabies-gamaglobulins bei Menschen, die von tödlichen Wölfen oder anderen Tieren schwer gebissen wurden. *Journal of Hygiene, Epidemiology, Microbiology and Immunology*, **3**, 168–180.
- Semple, D. (1919) On the nature of rabies and antirabic treatment. *BMJ*, **2**, 333–336.
- Shah, U. and Jaswal, G.S. (1976) Victims of a rabid wolf bite in India: effect of severity and location of bites on development of rabies. *Journal of Infectious Diseases*, **134**, 25–29.
- Suri, S.P. and Chugh, M.L. (1975) Hydrophobia—observations on 30 cases. *Journal of the Indian Medical Association*, **65**, 8–10.
- Tordo, N., Poch, O., Ermine, A. *et al.* (1986) Primary structure of leader RNA and nucleoprotein genes of the rabies genome: segmented homology with VSV. *Nucleic Acids Research*, **14**, 2671–2683.
- Tordo, N., Poch, O., Ermine, A. *et al.* (1988) Completion of the rabies virus genome sequence determination: highly conserved domains among the L (polymerase) proteins of unsegmented negative strand RNA viruses. *Virology*, **165**, 565–576.
- Veeraraghavan, N. (1969) The value of 5 per cent Semple vaccine in human treatment, comparative mortality among treated and untreated. *The Pasteur Institute of Southern India, Coonoor. Annual Report of the Director (1967) and Scientific Report (1968)*, pp 35–42. Dioscesan Press, Madras.
- Wang, S.P. (1956) Statistical studies of human rabies in Taiwan. *Journal of the Formosan Medical Association*, **55**, 548–553.
- Warrell, D.A. (1976) The clinical picture of rabies in man. *Transactions of the Royal Society of Tropical Medicine and Hygiene*, **70**, 188–195.
- Wilde, H., Sirikawin, S., Sabcharoen, A. *et al.* (1996) Failure of post-exposure treatment of rabies in children. *Clinical Infectious Diseases*, **22**, 228–232.
- Wilson, J.M., Hettiarachchi, J. and Wijesuriya, L.M. (1975) Presenting features and diagnosis of rabies. *Lancet*, **ii**, 1139–1140.

Papillomaviruses

Dennis J. McCance

University of Rochester, Rochester, New York, USA

INTRODUCTION

Papillomavirus is one of the two genera of the family of *Papovaviridae*; however, as will be seen, the viruses belonging to this group are quite different from those of the other genus, both in genome size and organization as well as pathogenesis.

The papillomaviruses (Latin *papilla* = nipple; *oma* = tumour) produce in their hosts benign skin tumors (papillomas), which contain variable amounts of infectious virus. Skin papillomas have been a recognized lesion since the fifth century BC; common hand warts and plantar warts are the most frequent skin papillomas of humans and until recently little clinical or scientific interest has been generated, since lesions were a cosmetic nuisance and the viruses were not thought to be involved in serious disease. Now that papillomaviruses (PVs) have been linked with squamous cell carcinoma (SCC) of mucosal and cutaneous epithelia, interest has been stimulated and significant advances in our understanding of the pathogenic process have been made.

CLASSIFICATION

At present papillomaviruses are classified into five supergroups, A (genital human papillomaviruses, HPV), B (associated with epidermodysplasia verruciformis), C (ungulate fibropapillomaviruses), D (bovine papillomaviruses causing true papillomas), and E (animal and human cutaneous papil-

lomaviruses). There are 11 groups under supergroup A, two each under B and C and one each under D and E. The classification results from the deduced evolutionary relationships amongst the papillomaviruses as judged by the sequence similarity of their genomes. For example, A9 contains the commonly isolated virus HPV-16 and the related viruses HPV-31, -33, -35, -52 and -58. Table 22.1 has a break down on the classification. Note that two of the animal viruses, rhesus monkey and pygmy chimpanzee papillomaviruses are grouped with the human genital isolates in group A9 and 10, respectively.

PHYSICAL AND CHEMICAL PROPERTIES

Structure

The capsids of the papillomaviruses have icosahedral symmetry containing 22 capsomeres with a diameter of 52–55 nm (Figure 22.1).

Genome

The HPV virion contains a double-stranded DNA molecule of 5×10^6 da molecular weight with an average of 7900 bp. The DNA, when in the virion, has a supercoiled circular configuration.

The molecular organization of the papil-

Table 22.1 Classification of the papillomavirus subfamily supergroups A–E

A											B		C		D		E
1	2	3	4	5	6	7	8	9	10	11	1	2	1	2			
32	3	61	2a	26	30	18	7	16	6b	34	5	4	B1	E1	B3		1a
42	10		27	51	53	45	40	31	11		8	48	B2	D1	B4		41
	28		57	69	56	39	43	33	13		9	50			B6		63
	29				66	59		35	44		12	60					Co
						68		52	55		14d	65					Ro
						70		58	P1		15						Cr
								67			17						
								R1			19						
											20						
											21						
											22						
											23						
											24						
											25						
											36						
											37						
											38						
											47						
											49						

R = Rhesus monkey papillomavirus; B = Bone papillomavirus; Cr = Cottontail rabbit papillomavirus; Co = Canine oral papillomavirus; D = Deer papillomavirus; E = Elk papillomavirus; Ro = Rabbit oral papillomavirus.
Adapted from the Los Alamos National Laboratory HPV database (Myers *et al.*, 1997).

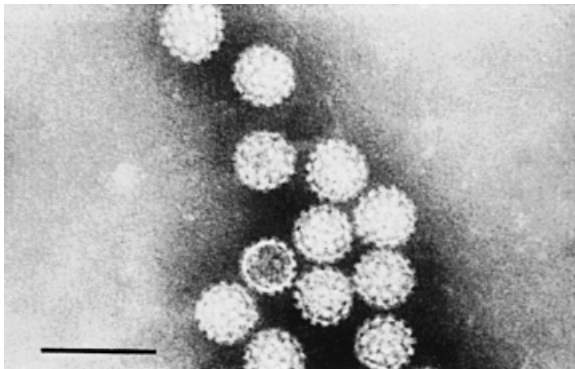

Figure 22.1 Electron micrograph of human papillomavirus from a genital wart. (Negative stain; $\times 154\,000$; bar = 100 nm) (Courtesy of Dr J.D. Oriel)

lomavirus genome is well conserved between viruses of various species and an example of one of the common genital isolates is shown in Figure 22.2. In this figure the genome is represented as a linear molecule with the boxed areas indicating the open reading frames (ORFs) and for convention is divided into two areas coding for early (E) and late (L) proteins. Because of the overlapping nature of the ORFs, the mRNAs transcribed are complex and it is not always clear which protein each codes. All

the ORFs are transcribed from the same strand and so are read in the same direction, remembering that transcription is in the 5' to 3' direction. HPV-16 (Figure 22.2) codes for five early and three late proteins. There is an upstream regulatory region (URR), which contains the major early promoter and enhancer elements for transcription of early genes and also contains the origin of replication. A late promoter for the transcription of the capsid protein mRNA has been identified and lies in the E7 ORF.

Viral Coded Proteins

There are five proteins coded for by the early region of the HPV genome. Because there are differences in the pathogenesis of various HPV types this is reflected in some of the functions of the early proteins. Therefore for brevity a short summary of the functions of HPV-16 (Figure 22.2) early protein is presented and their molecular weights are shown in Table 22.2.

Three of the early proteins, E6, E7 and E5, have

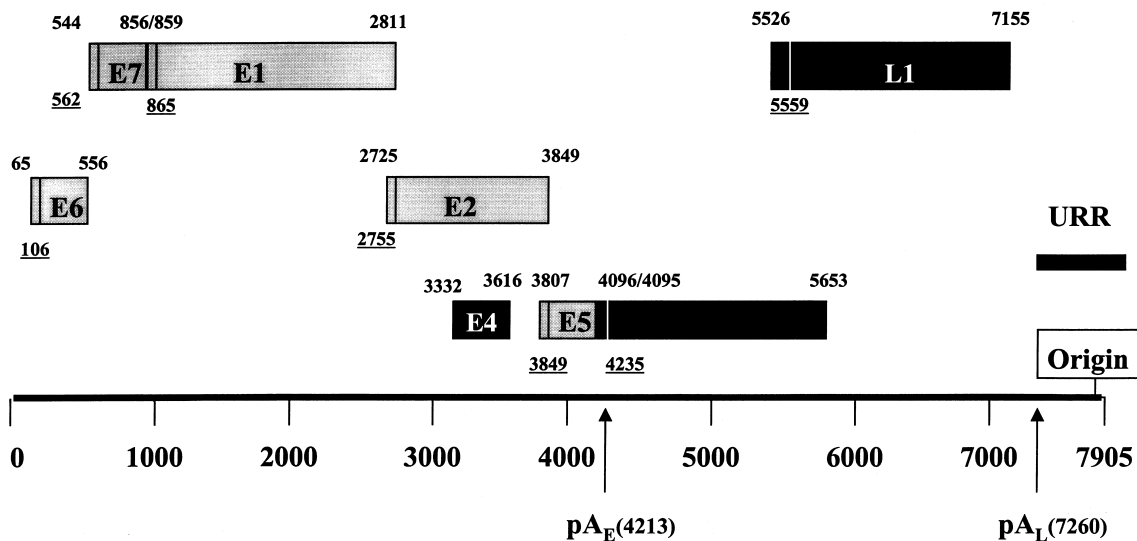

Figure 22.2 The genomic organization of HPV-16. The genome is circular, but represented as linear for clarity. The open reading frames (ORFs) are bound by nucleotide numbers and the line within the ORF represents the starting ATG; its nucleotide number is unlined. The pA_E and pA_L are the poly(A) signals for the early (E) and late (L) mRNAs, respectively. The URR is the upstream regulatory region which contains the major early promoter at p97 and the origin of replication (origin)

Table 22.2 Molecular weights of HPV-16 proteins

Protein	Molecular weight (kDa) ^a
E1	70
E2	45
E4	17
E5	8
E6	16
E7	11
L1	57
L1	55

^aMolecular weight on SDS-PAGE gels may be different, e.g. E7 runs at 15–16 kDa because of charged amino acids in the N-terminus of the protein, but codes for a protein of 11 kDa, and L1 runs at 75 kDa.

properties which are consistent with the virus having to stimulate the infected cells into S phase so the viral DNA has the cell's replicative machinery available for propagation of the genome. It has to be remembered that the virus is attempting to replicate in cells that are programmed to differentiate and so will have little or no replicative enzymes available to the virus. Both E6 and E7 are important for the efficient immortalization of human keratinocytes and have functions which disrupt the normal control of G_1 to S phase progression. E6 has been shown to bind the human p53 protein and

cause its rapid degradation through the ubiquitin proteolysis pathway (Schneffer *et al.*, 1990). E6 has also been shown to bind to a Ca^{2+} -binding protein called E6BP, which has homology to a cellular protein ERC-55 of unknown function (Chen *et al.*, 1995). E7 binds another cellular protein, the retinoblastoma gene product (pRB, Dyson *et al.*, 1989) and de-represses the inhibitory activity of Rb for transcription factors that are important for expression of genes, whose products are essential for DNA synthesis. Repression of transcription may be due to the binding by Rb of a histone deacetylase protein (Brehm *et al.*, 1998), which functions to condense chromatin and restrict the access of transcription factors to DNA. E7 appears to compete for the binding site of the deacetylase on Rb. Both these cellular proteins are negative regulators of the cell cycle and so interference with their normal function may allow cells to divide in an uncontrolled manner. E7 has also been shown to bind to various members of the AP-1 family of transcription factors and upregulate their activity (Antinore *et al.*, 1996).

E1 and E2 are involved in the replication of the HPV genome (see Viral Replication). E2 has additional functions in that it can positively and negatively regulate transcription from the early promoter. The full-length protein contains a transactivation domain at the 5' end and a DNA binding domain in the 3' half, and the active complex is a

dimer. Negative regulation of the HPV early promoter is due to the fact that one of the E2-binding sites lies next to the TATA box of this promoter and so E2 binding sterically inhibits binding of the TATA-binding protein and therefore inhibits initiation of the early transcripts.

E5 is a very membrane-associated hydrophobic protein with transforming activity for rodent fibroblasts. The E5 protein inhibits the acidification of endosomes (Straight *et al.*, 1995) by binding to the smallest subunit (16 kDa) of the vacuolar ATPase, a multicomponent proton pump. In human keratinocytes this results in the delay of the epidermal growth factor receptor (EGFR) degradation and a hyperstimulated cell. Since the EGFR is the major growth factor receptor on keratinocytes, this activity may be important for stimulating cells into S phase for viral DNA replication. E5 can transform rodent fibroblasts and in the presence of the epidermal growth factor there is an increase in the efficiency of transformation, which may be due to the delay in receptor degradation.

The late proteins L1 and L2 are the major and minor capsid proteins, respectively, of the virion. The DNA and amino acid sequences are highly conserved between HPV types, especially in the L1 protein. The amino acid homology can be as high as 76% between HPV-16 and -33 (group A9). However, even within groups of papillomaviruses type-specific epitopes predominate, although some weak cross-reactivity has been observed, so it is possible to differentiate between types on a serological basis (see next section).

The mRNA for E4 is detectable late in infection, although it has the prefix of an early gene. E4 interacts with the cell microfilaments, causing them to collapse (Doorbar *et al.*, 1991), but the motive for this interaction is not clear, although it has been suggested that this might allow the virions to be more easily released from the differentiated keratinocyte after transfer to a new susceptible host.

There are host coded histone proteins H2a, H2b, H3 and H4 associated with the viral DNA within the virion.

viral-like particles (VLPs) produced using baculovirus technology has been used to carry out serological studies on the relatedness of HPV and on a small scale to determine serological responses in infected patients. VLPs are produced when the major capsid protein, L1, is synthesized using baculovirus vectors and insect cells, and form into an icosahedral structure similar to that of the virion (Kirnbauer *et al.*, 1992). VLPs can also be produced which contain both the major (L1) and minor capsid protein (L2) and the latter appears to stabilize the icosahedral structure and also has been shown to possess neutralizing epitopes. To date, antiviral antibodies have been produced to virions of HPV-11 and -16 and these antibodies recognize VLPs of the L1 protein from HPV-11 and -16, respectively (Rose *et al.*, 1994). Therefore, VLPs are recognized by antibodies to infectious virus particles, and vice versa. The antibodies to VLPs or virions detect conformational epitopes, unlike earlier serological studies, where disrupted particles, or fusion proteins of L1 or peptides of regions of L1 were used either as targets or to raise antibodies to the L1 protein, and produced extensive cross-reactivity. This cross-reactivity was so complete that antibodies to disrupted BPV-1 particles recognized linear epitopes in most HPV types. Therefore, it is only with the production of VLPs that the serological differences between HPVs, even those closely related, became apparent. For example, within one group, say A9 containing HPV-16, -31 and -33, polyclonal antibodies only react well with the type to which the antibodies were raised, although cross-reactivity has been observed. The level of cross-reactivity is very low and is probably not relevant biologically in cross-protection. Monoclonal antibodies to virions or VLPs have shown that there are predominantly type-specific epitopes, although in closely related viruses such as HPV-6 and -11, where L1 is over 80% homologous at the amino acid level, cross-reactive epitopes have been observed.

VIRAL REPLICATION

SEROLOGY

While HPV cannot be propagated *in vitro* in any scale large enough to carry out serological studies,

Infection of tissue culture cells with papillomavirus particles and subsequent propagation of infectious virus has not been achieved. The major problem is that HPV virion production depends on differenti-

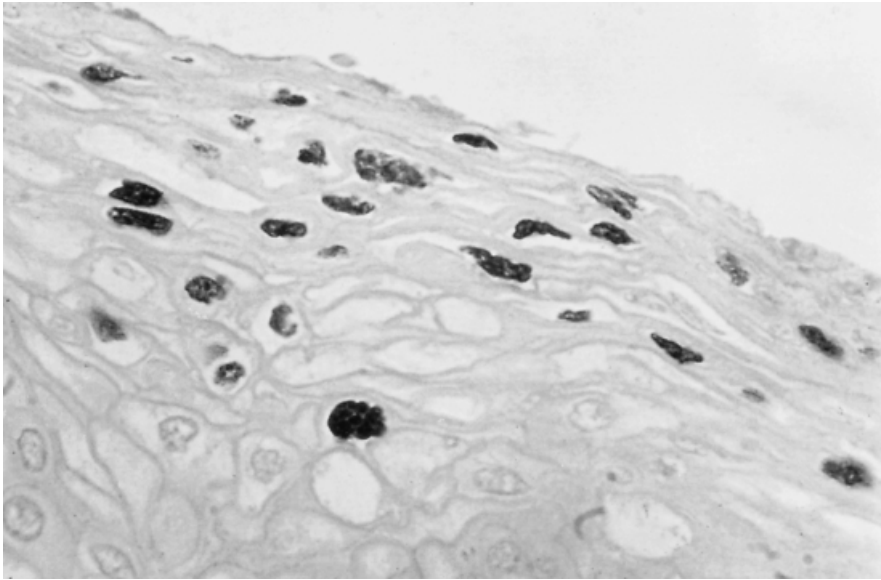

Figure 22.3 A section of biopsy containing CIN 1, showing nuclear staining of HPV-16 L1 antigen using a monoclonal antibody, followed by alkaline phosphatase tagged antimouse secondary antibodies. Note the dark staining nuclei are found in the outer differentiated part of the epithelium

ating epithelial cells, and by their nature these cells do not grow *in vitro*. However, Frattini *et al.* (1996) have shown that it is possible to transfect human keratinocytes, the natural host cell, with HPV-31 DNA, select cell lines containing episomal copies of HPV-31 DNA, and then differentiate the cells using the raft culture system and show that virus particle production occurs in the few cells in the uppermost part of the differentiated epithelium. The distribution of the virus particles is the same as that observed in infected epithelium (Figure 22.3). The level of virus production is very low and not enough to produce virus particles for serology or infectivity studies. However, propagation of HPV types has been successful in a nude mouse kidney capsule system and in human skin grafts on to the epithelium of SCID mice. In the former system human foreskin tissue fragments are mixed with a viral suspension of HPV and then the tissue is transplanted under the kidney capsule of a nude mouse. Over the next 60 days the tissue fragments grow and produce infectious HPV virus. Both HPV-11 and -16 have been propagated in this fashion; however, this system is obviously complex, requiring skills and animal facilities not available to all.

The origin of replication of HPV-11 and -31 (Lu *et al.*, 1993; Frattini and Laimins, 1994) has been mapped extensively and the region is conserved in other HPV types. The mapping has been achieved

by cloning the origin region into a bacterial vector and transfecting mammalian cells along with plasmids expressing the E1 and E2 proteins of the respective virus. The E1 and E2 proteins are the only HPV-specific products necessary for the replication of the origin-containing plasmid. The origin region of the DNA has been mapped to a region at the 3' end of the URR (Figure 22.2) and both E1 and E2 have specific DNA binding sites at the origin. In addition to binding at the origin, E1 and E2 can bind together and E1 has been shown to have ATPase and helicase activities, which are typical of viral proteins, such as SV40 large T, that are involved in the initiation of viral DNA replication.

NATURAL HISTORY OF HPV INFECTIONS

HPVs infect and replicate in squamous epithelium on both keratinized and mucosal surfaces. Most people are infected with the common HPVs (HPV-1, -2, -3, -4) in childhood and adolescence, usually on the hands and feet. A small group of individuals with the rare autosomal recessive disease epidermodysplasia verruciformis (EV) harbor a number of virus types not often isolated from normal people (Table 22.1, group B1 and 2). Two common presen-

tations in EV patients are multiple warts, which may be so numerous as to produce coalescent areas and dry, scaly flat lesions, which may be red or heavily pigmented. These latter skin lesions, although not having a wart-like appearance, contain many of the unusual types of HPV contained in Table 22.1, group B1 and 2. Squamous cell carcinomas develop in nearly one-third of patients with EV, usually in areas of skin exposed to the sun (face, neck and hands being most commonly affected); HPV-5 and -8 are found commonly in these lesions, while types -14, -17 and -20 account for a smaller number. While the viruses found in EV patients are not isolated from normal individuals, some types, such as 5 and 8, have been detected in squamous cell carcinomas in allograft recipients. Because the disease EV is rare, and with the isolation of some of the EV-associated HPVs from transplant patients, it suggests that these viruses must be circulating in the community, infecting normal individuals perhaps without any associated lesions.

As mentioned earlier there are mucotropic HPVs which infect mostly the genitourinary tract. Common isolates like HPV-6 and -11, which cause benign condyloma, can also infect the oral cavity, particularly the larynx. Infection of the larynx is rare, but usually requires several episodes of surgery or laser treatment for removal of recurrent lesions. Frequent recurrences may be due to the fact that only the visible lesions are treated, although healthy looking areas of mucosal tissue may harbour HPV genomes. The oral cavity is also infected with other HPV types associated with oral warts and hyperkeratosis.

Transmission is thought to occur from one epithelial surface to another in exfoliated cells containing infectious virus, rather than free virus particles. Therefore direct contact is the most efficient way to transmit infection. Direct contact through sexual intercourse is the most important mode of transmission of genital viruses. However, an infected mother may transmit virus to her neonate during delivery through the birth canal. This route of infection is thought to be a major cause of laryngeal warts in babies and young children. It is possible that other modes of transmission occur for the genital viruses, since a number of studies have detected DNA in young children. However, the route of transmission, apart from those mentioned above, is unclear.

Infection of the genital mucosa is common and

involves hundreds of thousands of new cases each year, usually among sexually active individuals, with 18–30-year-olds having the highest incidence (cf. common hand warts). With certain of the genital HPV types there is an increased risk of carcinomas, especially of the cervix; what is known of the natural history and pathogenesis of the genital viruses is discussed below.

PATHOGENESIS

HPVs cause benign and malignant changes in epithelial cells. It is the latter property that will be dealt with in this section, since certain types are the most important component of the aetiology of genital cancers, and cervical cancer is the most common cause of cancer-related death in women worldwide.

Oncogenic Potential of Papillomaviruses

Until recent epidemiological and laboratory-based studies, most of the evidence for an oncogenic potential of HPVs came from research with animal papillomaviruses. Work in the 1930s showed that the *Cottontail rabbit papillomavirus* (CRPV) produced benign tumors in this animal, its natural host, and that these benign tumors in 25% of cases would become malignant after 12 months. Benign tumours produced in domestic rabbits became malignant more frequently and within a shorter time. Also, application of hydrocarbons or tar produced in both animal species a higher and more rapid malignant conversion. The viral DNA was detected in both the benign and the malignant lesions. These results suggested that the CRPV produced the benign lesion, but other factors, genetic and environmental, may be necessary for production of malignant disease. More recently, oesophageal, intestinal and bladder papillomas produced by *Bovine papillomavirus 4* (BPV-4) were shown to become malignant when cattle were fed on a diet of bracken. In this case the BPV-4 DNA was detected only in the benign lesion and was not detectable after malignant conversion. Recently, *rhesus monkey papillomavirus 1* has been isolated from a lymph node metastasis of a penile carcinoma. This virus is transmitted sexually and is associated with both penile

and cervical cancers. This animal virus may service as a good, if expensive, model to investigate the natural history of papillomavirus infections.

In humans, one-third of patients with EV develop squamous cell carcinoma, usually in sun-exposed areas. Over 30% of these lesions contain HPV DNA, most commonly types 5 or 8. This suggests that, given the right environmental or genetic conditions, benign lesions may develop into carcinoma with the help of HPVs. Other evidence of a helper function associated with malignant conversion concerns laryngeal papillomas, which may convert from a benign to malignant state when treated by X-irradiation. With the increase in the number of allograft recipients there has been an increase in reports of squamous cell carcinomas at many different sites. The cutaneous cancers are associated with those viruses isolated from similar lesions in EV patients, and the genital cancers harbour the viruses found in similar cancers in immunocompetent individuals.

It is the genital papillomaviruses, which are responsible for the most common HPV-associated cancer, that will be discussed in more detail in the following sections.

Genital Cancers Associated with HPVs

While the association between the genital cancers, especially cervical cancer, is now known to be causal rather than casual, not everyone infected with an oncogenic HPV type will develop cancer. In fact, it appears that people can be infected without obvious evidence of disease and there are a number of reports of the detection of HPV DNA in the normal epithelium.

HPV Infection of the Normal Cervix

It has been observed for some time that HPV DNA could be detected in cervical cells from women with a normal cervix, as assessed by normal cytology, and no vision lesion upon colposcopic examination. The rate of detection has varied dramatically, depending on the method used to detect the DNA and the age and demographics of the age group studied. The most sensitive technique, the polymerase chain reaction (PCR, see Diagnosis), which is prone to

cross contamination, has recorded levels of 80% positivity in women with a normal cervix. These results have been shown to be erroneous due to cross-contamination problems in the early days of PCR. However, there is still a variation in isolation depending on the age and life style of the individuals studied. In studies of young women between 18 and 25 years of age up to 46% will have detectable HPV DNA by PCR (Bauer *et al.*, 1991) in epithelial cells from a normal cervix. HPV types 16 and 18, which are commonly found in malignant disease, account for about one-third of the viruses detected. Therefore a large number of young women may be infected with HPV types, which cause malignant disease. However, it is clear that only a small number will ever develop disease, but recognizing those at risk is not possible at present. HPV detection decreases in older women (>40 years of age) and is usually in the 5–10% range. While the level of infection is lower in older women, it has been shown that they are more likely to have underlying disease (see next section).

HPV Infection and the Abnormal Cervix

The most common genital lesion caused by HPV infection is the benign genital wart (condylomata acuminata). HPV-6 and -11 are the predominant types associated with these lesions, which are benign, and where the rare malignant conversion has only been documented in patients with an underlying immune deficiency. These warts are distributed throughout the female genital tract, on the cervix, vaginal wall, vulva and perianal region. In males the lesions are found on the penis, scrotum and perianal region.

The premalignant lesions associated with HPV can occur on the same sites as described above for warts, although the cervix is where malignant conversion is observed most often. The premalignant lesions of the cervix are called intraepithelial neoplasia and are graded, according to the Bethesda system (Kurman *et al.*, 1994), as low-grade squamous intraepithelial lesions (LSILs) or high-grade squamous intraepithelial lesions (HSILs). HPV-6 and -11 are found in LSILs, while the oncogenic types, HPV-16 and -18, are found in all grades and in malignant disease. Table 22.3 gives a breakdown of the oncogenic potential of HPV

Table 22.3 Genital HPVs and their associated risk of cancer

Low risk	6, 11, 40, 42–44, 53–55, 66
High risk	16, 18, 26, 31–35, 51–52, 56, 58, 61, 67–70, 73

types. The premalignant lesions occur almost entirely on the transformation zone, the metaplastic zone between native squamous epithelium of the exocervix and the columnar epithelium of the endocervical canal, and are white in appearance after the addition of 5% acetic acid to the surface of the epithelium. Invasive cancer arises from these areas of HSIL, and malignant cells migrate up into the uterus and out to local lymph nodes. HPV-16 is the most common virus found in intraepithelial and malignant disease. It has been found in 70% of cases of HSILs in Germany and the UK and has been isolated in 80% of cases of invasive cancer of the cervix.

HPV-6 and -11 have not been found in malignant disease of the cervix, but have been isolated from locally invading lesions of the vulva such as verrucous carcinoma. However, when the genome of the viruses isolated were sequenced, it was found that there were duplications in the long control region, which may be associated with the change in pathogenesis. The HPV types and associated lesions are shown in Table 22.4.

There is a difference in the state of the HPV-16 DNA in premalignant and malignant lesions. In LSILs and HSILs the HPV-16 DNA is free and unintegrated, while in the majority of malignant cells the DNA is integrated. While integration is random with the chromosomes, the HPV genome is integrated in the E1 or E2 regions of the DNA, resulting in the retention of the expression of the E6 and E7 proteins, which appear essential for the malignant phenotype. It is not clear how important integration is for invasive cancer to develop, since in a minority of cases the viral DNA is episomal in malignant cells.

Malignant disease of the penis, while rare in developed countries, is much more common in developing parts of the world. HPV-16 and -18 were detected in over 50% of penile cancers in Brazil (McCance *et al.*, 1986), where in one area of the northeast of the country the incidence of penile cancer is 10 times the frequency seen in Europe. Again in malignant disease of the penis the viral

Table 22.4 Genital HPV types and the site of associated lesions^a

HPV type	Associated lesion	Site
HPV-6a-f	Condylomata acuminata	Vulva
		Vagina
		Cervix
		Penis (shaft, prepuce, urethral meatus)
		Perianal
HPV-11a, b	Condylomata acuminata	Larynx
		Cervix
		Vulva
		Penis
HPV-16	Condylomata acuminata	Vulva, cervix and penis
		Cervix
		Vulva
		Penis
		Bowenoid papulosis
HPV-18	Malignant carcinoma	Cervix, vulva and penis
		LSIL/HSIL
		LSIL/HSIL
		LSIL/HSIL
		LSIL/HSIL
		LSIL/HSIL
		LSIL/HSIL
		LSIL/HSIL
		LSIL/HSIL
		LSIL/HSIL
		LSIL/HSIL
		LSIL/HSIL
		LSIL/HSIL
		LSIL/HSIL
		LSIL/HSIL
HPV-31	Malignant carcinoma	Cervix and penis
		LSIL/HSIL
		LSIL/HSIL
		LSIL/HSIL
		LSIL/HSIL
		LSIL/HSIL
		LSIL/HSIL
		LSIL/HSIL
		LSIL/HSIL
		LSIL/HSIL
HPV-33	Malignant carcinoma	Cervix
		LSIL/HSIL
		LSIL/HSIL
		LSIL/HSIL
		LSIL/HSIL
		LSIL/HSIL
		LSIL/HSIL
		LSIL/HSIL
		LSIL/HSIL
		LSIL/HSIL
HPV-35	Malignant carcinoma	Cervix
		LSIL/HSIL
		LSIL/HSIL
		LSIL/HSIL
		LSIL/HSIL
		LSIL/HSIL
		LSIL/HSIL
		LSIL/HSIL
		LSIL/HSIL
		LSIL/HSIL
HPV-39	Malignant carcinoma	Cervix and penis
		LSIL/HSIL
		LSIL/HSIL
		LSIL/HSIL
		LSIL/HSIL
		LSIL/HSIL
		LSIL/HSIL
		LSIL/HSIL
		LSIL/HSIL
		LSIL/HSIL
HPV-40	Malignant carcinoma	Cervix
		LSIL/HSIL
		LSIL/HSIL
		LSIL/HSIL
		LSIL/HSIL
		LSIL/HSIL
		LSIL/HSIL
		LSIL/HSIL
		LSIL/HSIL
		LSIL/HSIL
HPV-42	Malignant carcinoma	Cervix and vulva
		LSIL/HSIL
		LSIL/HSIL
		LSIL/HSIL
		LSIL/HSIL
		LSIL/HSIL
		LSIL/HSIL
		LSIL/HSIL
		LSIL/HSIL
		LSIL/HSIL
HPV-43	Malignant carcinoma	Cervix
		LSIL/HSIL
		LSIL/HSIL
		LSIL/HSIL
		LSIL/HSIL
		LSIL/HSIL
		LSIL/HSIL
		LSIL/HSIL
		LSIL/HSIL
		LSIL/HSIL
HPV-44	Malignant carcinoma	Cervix
		LSIL/HSIL
		LSIL/HSIL
		LSIL/HSIL
		LSIL/HSIL
		LSIL/HSIL
		LSIL/HSIL
		LSIL/HSIL
		LSIL/HSIL
		LSIL/HSIL
HPV-45	Malignant carcinoma	Cervix
		LSIL/HSIL
		LSIL/HSIL
		LSIL/HSIL
		LSIL/HSIL
		LSIL/HSIL
		LSIL/HSIL
		LSIL/HSIL
		LSIL/HSIL
		LSIL/HSIL
HPV-51	Malignant carcinoma	Cervix
		LSIL/HSIL
		LSIL/HSIL
		LSIL/HSIL
		LSIL/HSIL
		LSIL/HSIL
		LSIL/HSIL
		LSIL/HSIL
		LSIL/HSIL
		LSIL/HSIL
HPV-52	Malignant carcinoma	Cervix
		LSIL/HSIL
		LSIL/HSIL
		LSIL/HSIL
		LSIL/HSIL
		LSIL/HSIL
		LSIL/HSIL
		LSIL/HSIL
		LSIL/HSIL
		LSIL/HSIL
HPV-53	Malignant carcinoma	normal cervix
		Penis
		Penis
		Penis
		Penis
		Penis
		Penis
		Penis
		Penis
		Penis
HPV-54	Malignant carcinoma	Cervix
		LSIL/HSIL
		LSIL/HSIL
		LSIL/HSIL
		LSIL/HSIL
		LSIL/HSIL
		LSIL/HSIL
		LSIL/HSIL
		LSIL/HSIL
		LSIL/HSIL
HPV-55	Malignant carcinoma	Cervix
		LSIL/HSIL
		LSIL/HSIL
		LSIL/HSIL
		LSIL/HSIL
		LSIL/HSIL
		LSIL/HSIL
		LSIL/HSIL
		LSIL/HSIL
		LSIL/HSIL
HPV-56	Malignant carcinoma	Cervix
		LSIL/HSIL
		LSIL/HSIL
		LSIL/HSIL
		LSIL/HSIL
		LSIL/HSIL
		LSIL/HSIL
		LSIL/HSIL
		LSIL/HSIL
		LSIL/HSIL
HPV-57	Malignant carcinoma	Oral cavity, cervix
		Intraepithelial neoplasia
		LSIL/HSIL
		LSIL/HSIL
		LSIL/HSIL
		LSIL/HSIL
		LSIL/HSIL
		LSIL/HSIL
		LSIL/HSIL
		LSIL/HSIL
HPV-58	Malignant carcinoma	Cervix
		LSIL/HSIL
		LSIL/HSIL
		LSIL/HSIL
		LSIL/HSIL
		LSIL/HSIL
		LSIL/HSIL
		LSIL/HSIL
		LSIL/HSIL
		LSIL/HSIL
HPV-59	Malignant carcinoma	vulva
		LSIL/HSIL
		LSIL/HSIL
		LSIL/HSIL
		LSIL/HSIL
		LSIL/HSIL
		LSIL/HSIL
		LSIL/HSIL
		LSIL/HSIL
		LSIL/HSIL
HPV-61	Malignant carcinoma	cervix
		LSIL/HSIL
		LSIL/HSIL
		LSIL/HSIL
		LSIL/HSIL
		LSIL/HSIL
		LSIL/HSIL
		LSIL/HSIL
		LSIL/HSIL
		LSIL/HSIL
HPV-66	Malignant carcinoma	cervix
		LSIL/HSIL
		LSIL/HSIL
		LSIL/HSIL
		LSIL/HSIL
		LSIL/HSIL
		LSIL/HSIL
		LSIL/HSIL
		LSIL/HSIL
		LSIL/HSIL
HPV-68	Malignant carcinoma	cervix
		LSIL/HSIL
		LSIL/HSIL
		LSIL/HSIL
		LSIL/HSIL
		LSIL/HSIL
		LSIL/HSIL
		LSIL/HSIL
		LSIL/HSIL
		LSIL/HSIL

LSIL/HSIL = low-grade squamous intraepithelial lesion and high-grade squamous intraepithelial lesion; VIN = vulvar intraepithelial neoplasia; PIN = penile intraepithelial neoplasia.

^aDe Villiers (1989).

DNA is integrated into the host cell chromosomes.

While HPV types have a role in the aetiology of cervical cancer, there are certainly other factors involved that act with the virus to produce invasive disease, since not everyone infected and exhibiting premalignant lesions will develop cancer. It is estimated that up to 25% of women with LSILs will progress to HSILs, while most will regress over a 3 year period. However, in older women (>40 years of age) infection and persistence more commonly leads to disease, and so they are potentially a group to be closely monitored (McCance, 1998). The cofactors involved have not been delineated, although smoking maybe one such component.

Persistence of Infection

Epidemiological evidence suggests that HPVs may persist in squamous epithelium without producing recognizable lesions. Up to 50% of allograft recipients develop cutaneous warts within a year after transplant, this proportion being high when compared with the incidence in age-matched controls. This suggests that transplanted patients experience either new infections or reactivation of persistent virus, the latter being supported by the finding of HPV DNA sequences in biopsies of normal areas of larynx from individuals who have had episodes of laryngeal papillomas. As the recurrence rate of laryngeal warts is high, this suggests that the virus is capable of persisting somewhere in the respiratory tract or oral cavity without producing recognizable lesions—an inapparent infection.

Also the viruses associated with some of the lesions in EV patients are not found normally in lesions from immunocompetent individuals, yet EV is such a rare disease that these patients cannot circulate the viruses among themselves. It would seem that these viruses are circulating in the normal population, causing inapparent infections.

In addition, during pregnancy genital warts can appear on the vulvar epithelium and then disappear postpartum. It is not known if this is a hormonal effect or due to perturbations in the immune response that often accompany pregnancy or the result of the woman acquiring a recent infection from her partner. In none of the above situations is there any direct evidence as to which cells harbour the virus. The basal epithelial cells are the most likely

site, although there is a considerable turnover of cells. However, not all cells in the basal epithelium have the same capacity to divide, so the viral DNA may be sequestered in some quiescent basal cells, which, when they divide subsequently, may activate replication and produce lesions.

DIAGNOSIS

Apart from the familiar hand or verruca wart, the clinical appearance of papillomavirus infections varies considerably, from the scaly flat lesions on cutaneous epithelium of individuals with EV to the aceto-white flat lesions on the cervix. The reader is referred to specific papers for details of the clinical presentation (Walker *et al.*, 1983). This section will deal with the laboratory diagnosis of HPV, in particular the genital isolates.

Culture Methods

Although several efforts have been made, no easily amenable cell type has been capable of supporting replication with production of infectious papillomavirus particles. The nude mice kidney capsule model system has been used to propagate some HPV types, but cannot be considered an *in vitro* system.

Serological Methods

Recently, with the advent of baculovirus-produced VLPs, it is now possible to detect antibodies by ELISA technique in the serum of patients infected with HPV. At present there are limited numbers of HPV types that have been used in these assays, but the initial results suggest that antibodies are detected in approximately 50% of infected individuals, which is less sensitive than DNA-based detection methods. These assays have only been carried out for some of the genital isolates. The reason for the low positivity rates in infected people is unclear, but it has to be remembered that the virus is confined to the stratified epithelium of the genital tract and few cells in a lesion support viral particle production. In addition, the mature viral particles are only produced in the outer layers of the epithelium, where

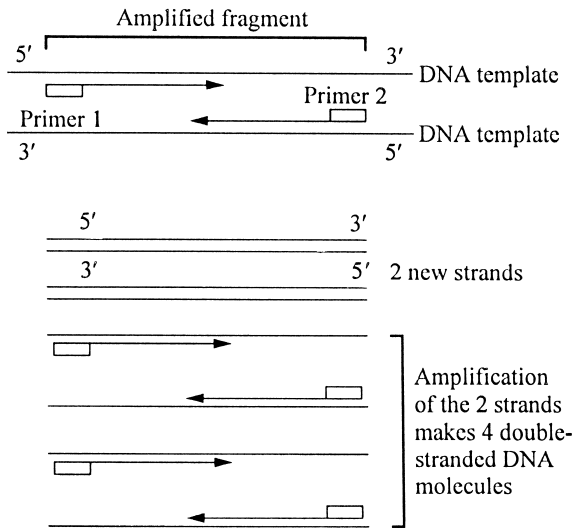

Figure 22.4 This represents the amplification of a specific region of an HPV genome by the polymerase chain reaction (PCR) using a set of primers, 1 and 2, which recognize homologous areas of the HPV genome. The first cycle results in two new double-stranded fragments; the second cycle makes four double-stranded fragments and so on, so that after 20 cycles 10^6 double-stranded fragments are produced

the immune response is at its least effective. Taken together, the results and the natural history of the virus suggest that it is not very immunogenic. However, vaccine trials have taken place to immunize dogs against oral papillomavirus infection (Suzich *et al.*, 1995). The dogs were immunized intramuscularly with VLPs of canine oral papillomavirus and then challenged with live virus placed on scarified areas of the oral cavity. Protection was 100%, indicating that it is possible to immunize against infection with intramuscular inoculations, although it still does not argue that, in the natural infection, confinement to the epithelium is a problem for recognition by the host defence mechanisms.

Polymerase Chain Reaction

The most common and sensitive method for the detection of HPV infection is by PCR. This is a powerful technique which amplifies a specific piece of DNA from a small amount of template (Figure 22.4). The advantages of this method are: (1) the extreme sensitivity; (2) the versatility, in that it can be used to detect more than one type of HPV when

degenerate primers are used—in fact it is possible to detect even unknown HPV types (ones that have not been cloned and sequenced); and (3) it is possible to test large populations. The major disadvantage is that, because of the sensitivity of the method, it is possible to amplify contaminating sequences and so have false positives. This was a major problem in the beginning, but now that it is recognized investigators have been more careful and included strict controls.

One of the primer sets used widely amplifies a region of L1, which is the most highly conserved ORF of HPV. This set will amplify all the known HPV types and then, to determine which one has been amplified, the sequences are hybridized to a DNA fragment made up of the intervening sequences of specific HPV types. These consensus primers have been used by a number of investigators for epidemiological studies.

Hybrid Capture Method

This method is available commercially in kit form (Digene Diagnostics, MD, USA), and uses type-specific RNA probes to detect viral DNA in samples. This method is not as sensitive as PCR but does not have the problems of false positives associated with PCR, since it does not rely on the amplification of the signal. It also detects only 16 mucosal types, whereas PCR can theoretically detect all HPV types.

TREATMENT

Although in most cases warts are a cosmetic nuisance which will disappear eventually spontaneously, they are notoriously difficult to treat. However, as intraepithelial lesions, especially on the cervix, may lead to malignant disease, treatment to eliminate disease is important. This section will concentrate on the treatment of genital areas, as others (Bunney, 1982) have dealt extensively with common hand and plantar warts.

Popophyllin

Popophyllin is a resin mixture obtained from the

roots of podophyllum (American Mandrake) and is an irritant on cutaneous and mucous surfaces. It is an antimitotic agent and should be used with care. It is painted carefully on to the surface of warts and should remain for no longer than 6 hours and then be washed off. It is adsorbed poorly by cutaneous surfaces and so has a limited effect. Several treatments are required and the continual inflammation produced can lead to fibrosis of the areas treated, without getting rid of the lesions. Podophyllin is even less effective for treatment of plantar warts and should never be used for treatment of hand warts.

Cryotherapy

Liquid nitrogen (-190°C) and dry ice (solid carbon dioxide, -50°C) can be applied to warts to produce local destruction of the lesion. Care should be taken to limit application to the lesion and not surrounding areas, as this will lead to pain and blistering of the healthy area. Cryoprobes are used to apply these cryogens to the cervix.

Electrodiathermy

This is used for treating mucosal lesions, such as those on the cervix, to destroy the diseased tissue by heat.

Laser Evaporation

The carbon dioxide laser has been used to treat lesions on mucosal surfaces (cervix and vaginal wall) (Singer and Campion, 1985) as well as cutaneous lesions. The success rate of laser treatment of the cervix is as good, if not better than, conventional techniques (i.e. 85–90%). However, its efficacy with cutaneous lesions has not as yet been assessed adequately. The difficulty with these lesions is knowing how deep to vaporize to eliminate diseased tissue.

Loop Electrosurgical Excision Procedure (LEEP)

This is a relatively new procedure for the removal of

cervical lesions and makes use of a heated loop, which removes very precisely the complete lesion. One advantage over laser evaporation is that the lesion is removed intact and the tissue can be used for pathological staging without having to biopsy the lesion first. Additionally, it allows the lesion to be used for other studies, such as HPV typing.

Surgery

Curettage of common warts is not a common mode of treatment. In any case, not all warts are suitably sited for surgical removal. Furthermore, if all the abnormal tissue is not moved, small islands of warts can recur around the site of the initial lesion.

Interferon

Interferon has been used to treat recurrent laryngeal warts and cervical intraepithelial neoplasia (CIN). In the former cases, tumour load was first reduced by surgery or by carbon dioxide laser—interferon then being given parenterally. Although recurrences were rare within 2 years of starting the interferon course, it was necessary to maintain patients on interferon to prevent new lesions. The expense of this regimen and possible side-effects associated with interferon administration provide drawbacks to this method of treatment. CIN lesions have also been treated with interferon, but variable results have been reported.

REFERENCES

- Antinore, M.J., Birrer, M.J., Patel, D. *et al.* (1996) The human papillomavirus type E7 gene product interacts with and transactivates the AP-1 family of transcription factors. *EMBO Journal*, **15**, 1950–1960.
- Bauer, H.M., Greer, C.E., Chambers, J.C. *et al.* (1991) Genital human papillomavirus infection in female university students as determined by a PCR-based method. *JAMA*, **265**, 472–477.
- Brehm, A., Miska, E.A., McCance, D.J. *et al.* (1998) Retinoblastoma protein recruits histone deacetylase to repress transcription. *Nature*, **391**, 597–601.
- Bunney, M.H. (1982) *Viral Warts: Their Biology and Treatment*. Oxford University Press, Oxford.
- Chen, J.J., Reid, C.E., Band, V. *et al.* (1995) Interaction of papillomavirus E6 oncoproteins with a putative calcium-binding protein. *Science*, **269**, 529–531.
- De illiers, E-M. (1989) Heterogeneity of the human papil-

- lomavirus group. *Journal of Virology*, **63**, 4898–4903.
- Doorbar, J., Ely, S., Sterling, J. *et al.* (1991) Specific interaction between HPV-16 E1-E4 and cytokeratins results in collapse of the epithelial cell intermediate filament network. *Nature*, **352**, 824–826.
- Dyson, N., Howley, P.M., Munger, K. *et al.* (1989) The human papillomavirus 16 E7 oncoprotein is able to bind to the retinoblastoma gene product. *Science*, **243**, 934–937.
- Frattoni, M.G. and Laimins, L.A. (1994) The binding of the human papillomavirus E1 origin-recognition protein is regulated through complex formation with E2 enhancer-binding protein. *Proceedings of the National Academy of Sciences of the USA*, **91**, 12398–12402.
- Frattoni, M.G., Lim, H. and Laimins, L.A. (1996) *In vitro* synthesis of oncogenic human papillomaviruses requires episomal templates for differentiation-dependent late expression. *Proceedings of the National Academy of Sciences of the USA*, **93**, 3062–3067.
- Kirnbauer, R., Booy, F., Cheng, N. *et al.* (1992) Papillomavirus L1 major capsid protein self-assembles into virus-like particles that are highly immunogenic. *Proceedings of the National Academy of Sciences of the USA*, **89**, 12280–12284.
- Kurman, R.J., Henson, D.E., Herbst, A.L. *et al.* (1994) Interim guidelines for the management of abnormal cervical cytology. *JAMA*, **271**, 1866–1869.
- Lu, J.Z.-J., Sun, Y.-N., Rose, R.C. *et al.* (1993) Two E2 binding sites (E2BS) alone or one E2BS plus an A/T-rich region are minimal requirements for the replication of the human papillomavirus type 11 origin. *Journal of Virology*, **67**, 7131–7139.
- McCance, D.J. (1998) Human papillomaviruses and cervical cancer. *Journal of Medical microbiology*, **47**, 371–373.
- McCance, D.J., Kalache, A., Ashdown, K. *et al.* (1986) Human papillomavirus types 16 and 18 in carcinomas of the penis from Brazil. *International Journal of Cancer*, **37**, 55–60.
- Myers, G., Baker, C., Munger, K. *et al.* (eds) (1997) *Human Papillomavirus. A Compilation and Analysis of Nucleic Acid and Amino Acid Sequences*. Theoretical Biology and Biophysics, Los Alamos National Laboratory, Los Alamos NM.
- Rose, R.C., Bonnex, W., Da Rin, C. *et al.* (1994) Serological differentiation of human papillomavirus types 11, 16, and 18 using recombinant virus-like particles. *Journal of General Virology*, **75**, 2445–2449.
- Schneffer, M.B., Werness, B.A., Huibregtse, J.M. *et al.* (1990) The E6 oncoprotein encoded by human papillomavirus types 16 and 18 promotes degradation of p53. *Cell*, **63**, 1129–1136.
- Singer, A. and Campion, M.J. (1985) Modern treatment of cervical precancer. *Journal of Obstetrics and Gynaecology*, **5** (suppl.), 564–569.
- Straight, S.W., Herman, B. and McCance, D.J. (1995) The E5 oncoprotein of human papillomavirus type 16 inhibits the acidification of endosomes in human keratinocytes. *Journal of Virology*, **69**, 3185–3192.
- Suzich, J.A., Ghim, S.-J., Palmer-Hill, F.J. *et al.* (1995) Systemic immunization with papillomavirus L1 protein completely prevents the development of viral mucosal papillomavirus. *Proceedings of the National Academy of Sciences of the USA*, **92**, 11553–11557.
- Walker, P.G., Singer, A., Dyson, J. *et al.* (1983) Colposcopy in the diagnosis of papillomavirus infection of the uterine cervix. *British Journal of Obstetrics and Gynaecology*, **90**, 1082–1086.

Human Polyomaviruses

Kristina Dörries

Julius-Maximilians University, Würzburg, Germany

CLASSIFICATION AND DETECTION

The human polyomaviruses are members of the polyomavirinae subfamily in the family *Papovaviridae*. The small non-enveloped viruses of about 40 nm in diameter contain single genomes of covalently closed superhelical double-stranded DNA. Although mouse polyomavirus was detected almost 50 years ago, the existence of primate polyomaviruses was not realized until the 1960s, with the detection of *Simian virus 40* (SV40) in monkeys. Ten years later, the human polyomaviruses, *JC* (JCV) and *BK* (BKV), were detected by isolation of JCV from the brain of a patient with progressive multifocal leucoencephalopathy (PML) in human fetal brain spongioblast cultures, and of BKV in tissue culture inoculated with urine of a renal transplant recipient (Padgett and Walker, 1976; Zu Rhein, 1969).

VIRION STRUCTURE AND COMPOSITION

Polyomaviruses are non-enveloped viruses with capsids containing three virus-encoded proteins—VP1, VP2, VP3. The icosahedral shell surrounds a DNA molecule that is stabilized by cellular histones in a chromatin structure. From studies on SV40 and *Murine polyomavirus* it is known that 360 molecules of the major capsid protein VP1 are associated with approximately 30–60 molecules of each of the minor capsid proteins VP2 and VP3. Virus prepara-

tions contain at least two kinds of particles. Passage of polyomaviruses at high multiplicity is followed by the generation of considerable amounts of empty capsids. In addition, defective viral genomes containing deletions, duplications and rearrangements of viral genetic information may be found. These molecules may be encapsidated if they are within the appropriate size limits (Hogan *et al.*, 1984). In contrast, *in vivo* the amount of empty shells is considerably reduced, pointing to a highly effective virus growth under natural conditions. Complete virus particles form a band at a density of 1.34 g ml^{-1} in CsCl_2 equilibrium density gradients, whereas empty capsids have a density of about 1.29 g ml^{-1} (Figure 23.1).

Although the structure of the human polyomavirus capsids is not yet known completely, it was reported that recombinant JCV VP1 self-assembles into pentameric capsomers, and under appropriate conditions these molecules will further assemble into virus-like empty capsids (Chang *et al.*, 1997; Frye *et al.*, 1997). Calcium ions are required for capsid stability and disulphide bonds might exist between capsid proteins, as reducing agents are required to disassemble virus particles. The human polyomaviruses are able to haemagglutinate erythrocytes at high virus concentrations. Each virus also has distinct antigenic epitopes and can be distinguished by neutralization and haemagglutination inhibition assays (Pass and Shah, 1982).

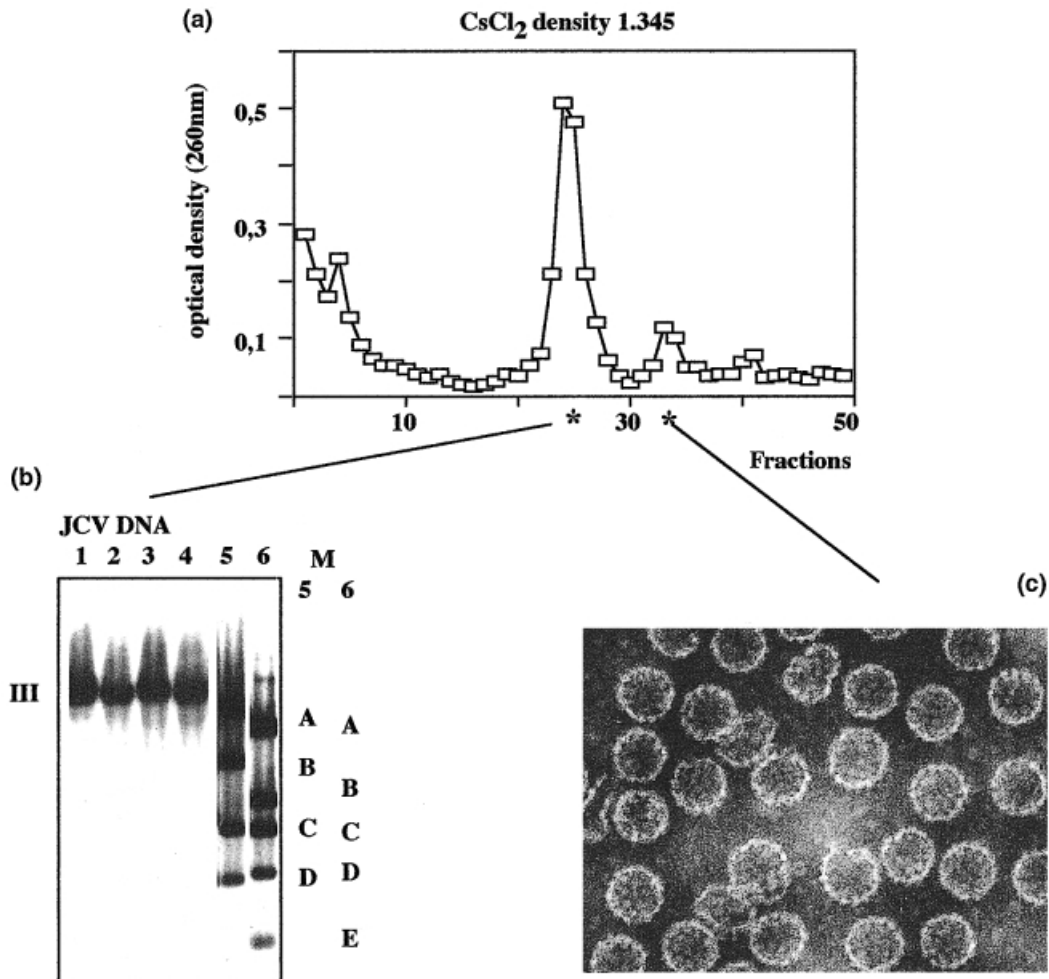

Figure 23.1 JCV purification out of PML brain tissue. (a) Optical profile of the centrifugation with banding of virus particles in two bands (*); intact virus particles at a density of 1.345 g ml^{-1} CsCl₂. (b) Restriction endonuclease cleavage of DNA extracted from the major peak of the gradient followed by Southern blotting and JCV specific radioactive hybridization. 1–4 cleavage with single-cut enzymes *EcoRI*, *BamHI*, *HpaI* and *PstI* generating linearized form III DNA at about 5 kb in length; 5, 6 cleavage with single and more cut enzymes in combination (*BamHI/PvuII*, *BamHI/HindIII*) generating DNA fragments (M 5,6) A–D and A–E. (c) Electron micrograph of negatively stained JCV icosahedral virus particles of the small virus peak representing empty particles without encapsidated viral DNA

VIRUS LIFE CYCLE

Polyomavirus expression is essentially divided into three major phases. After expression of the early protein large T antigen (TAg), early postinfection, TAg initiates replication of viral DNA. Shortly after onset of DNA replication, virus multiplication enters the late phase, which is characterized by the expression of late mRNAs followed by production of viral capsid proteins and virion assembly. Regu-

lated by complex interactions of viral promoter elements with cellular factors, late genes are expressed efficiently only after DNA replication. In contrast, early genes continue to be expressed at late stages of infection, then serving as viral transcription factor. The functional specificity of TAg molecules in the virus life cycle appears to be regulated by consecutive phosphorylation events.

In comparison to other polyomaviruses, JCV has a long lytic life cycle with an early transcription and DNA replication phase lasting about 5 days, fol-

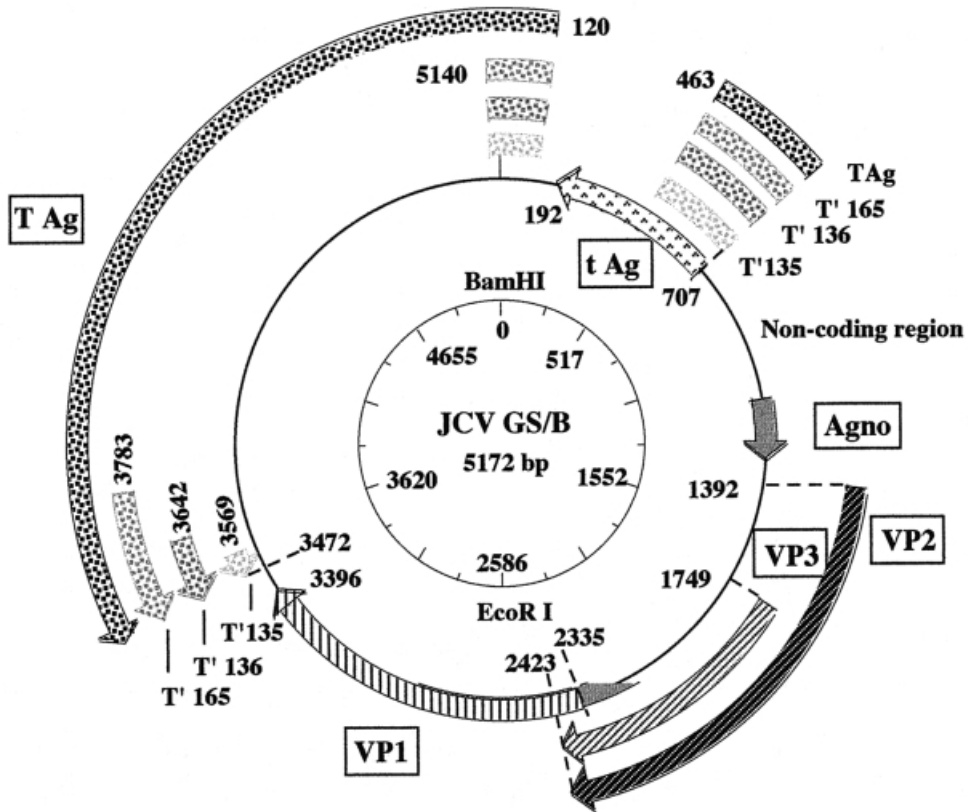

Figure 23.2 Circular genomic map of the human polyomavirus JC subtype GS/B. Coding DNA segments are represented by shaded arrows. Numbers designate the first nucleotide of the start and stop codons for the proteins (Loeber and Dörries, 1988). Position of splice donor and acceptor sites are indicated. The position of the unique *Bam*HI and *Eco*RI restriction sites are indicated on the inner circle

lowed by continuing initiation of late RNAs for 15–20 days. The virus has a stringent cell specificity and replicates efficiently *in vitro* only in primary human fetal glial cell cultures, rich in spongioblasts, a precursor cell of oligodendrocytes (Padgett, 1983; Frisque *et al.*, 1984). In other cell lines from embryonic kidney, amnion or urine-derived epithelium virus growth is rather limited. In contrast, BKV has a broader cell specificity and can be grown in a wide range of human cell types.

Molecular Structure of the Genome

The genomic structure is highly related among the primate polyomaviruses. The circular DNA of the human viruses is about 5100 bp in length (Figure 23.2). The genome is divided into two regions en-

coding multiple overlapping genes. Each DNA strand carries about one half of the genetic information. Early and late mRNAs are synthesized bidirectionally from opposite strands of the genome. Protein coding sequences consist of open reading frames for the early regulatory proteins and for the late proteins, the regulatory agnogene and the virus capsid proteins. Activity and specificity of virus multiplication is directed by the non-coding region. It is divided into two regulatory segments with a single origin of DNA replication (ORI) and the transcriptional control elements (TCR) within the promoter region (Loeber and Dörries, 1988; Frisque and White, 1992).

The coding sequences exhibit high DNA sequence homology. Homology between the human viruses is greater in all proteins than between JCV and SV40 (69%). JCV DNA shares between 83% and 59% amino acid homology with BKV for TAg

Table 23.1 Human polyomavirus early and late proteins

Proteins	BKV		JCV	
	Size (aa)	Mol. wt (kDa)	Size (aa)	Mol. wt (kDa)
<i>Early</i>				
tAg	172	20	172	20.2
TAg	695	90	688	79.3
T ¹³⁵	NR	NR	135	17
T ¹³⁶	NR	NR	136	22
T ¹⁶⁵	NR	NR	165	23
<i>Late</i>				
Agno	66	NR	71	NR
VP1	362	46 ^a	354	39.6
VP2	351	40.5 ^a	344	37.4
VP3	232	30.5 ^a	225	25.7

^aMolecular weight varies considerably between laboratories. aa = amino acids; NR = not reported.

and agnogene, respectively. The rates might be even higher in functionally active regions of the virus genes. The early region codes for the regulatory proteins, the tumour or T antigens (Table 23.1). Both human polyomaviruses encode two proteins small t and large T antigen, so-called on the basis of size. The multifunctional T antigen is essential for control of the virus life cycle. Although the human polyomavirus proteins are not studied to the same extent as those of SV40, extensive sequence homology points to similar functional activities, including effects on nuclear localization, on viral DNA replication by direct DNA binding activities and binding to DNA polymerase α that initiates DNA replication, on cellular transformation by interaction with tumour suppressor proteins, and as a transcription factor known to be crucial for the regulation of early and late promoter activities.

The tumour antigens are generated from a common pre-mRNA molecule by one alternative splicing event leading to identical N-terminal and different C-terminal DNA sequences. Recently, three additional early virus proteins, T¹³⁵, T¹³⁶, and T¹⁶⁵ were characterized in JCV-infected cells (Trowbridge and Frisque, 1995). All T proteins use the first alternate splice donor site leading to the same 132 N-terminal amino acids. For T¹³⁵ and T¹³⁶ a second splice donor site is combined with alternate acceptor sites. Whereas T¹⁶⁵ shares the C-terminus with TAg, T¹³⁵ and T¹³⁶ have unique ends encoded by an alternate reading frame. Although the role of these molecules in the virus life cycle is

not yet clear, increased expression of these '17kDa' species was correlated with enhanced transforming activity of JCV and might be involved in the control of viral DNA replication. Additionally, it has been proposed that the transactivating function of TAg might be influenced by T¹³⁵ as a transdominant repressor affecting the balance of viral persistence and productive infection.

The late region of the viral genome encodes two minor capsid proteins, VP2 and VP3, and a major capsid protein, VP1. Late mRNAs are generated from a common precursor by alternative splicing. The coding sequences of the minor proteins VP2 and VP3 are overlapping. VP2 contains the entire VP3 sequence at its C-terminus and an additional sequence of approximately 400 amino acids at its N-terminus. In contrast, the major protein VP1 is generated by an alternative reading frame. The primate polyomaviruses encode a fourth late protein, the non-structural agnoprotein. The open reading frame is located in the late leader region and the protein is probably involved in the morphogenesis of virus particles by inhibiting self-polymerization of VP1 and the localization of the major capsid protein to the nucleus.

The non-coding part of the genome is framed by the start codons for early and late genes. The ORI is located between the TATA box and the initiation codon for the early genes. This segment includes the conserved binding sites for large TAg. Corresponding to similar DNA replication strategies, the polyomavirus ORI DNA segment is highly conserved in sequence and structure. In contrast, the promoter region to the late side of the control region reveals extensive differences. Heterogeneity of structure and sequence of individual transcription factor binding sites is reflected in the divergent cell type specificity and activity of transcription among the species and human polyomavirus subtypes (Dörries, 1997).

Control of Viral Gene Expression

DNA Replication

Regulatory mechanisms leading to DNA replication are closely related among the polyomaviruses. This is reflected in an origin of DNA replication being constructed by protein binding elements with comparable sequence and spacing requirements

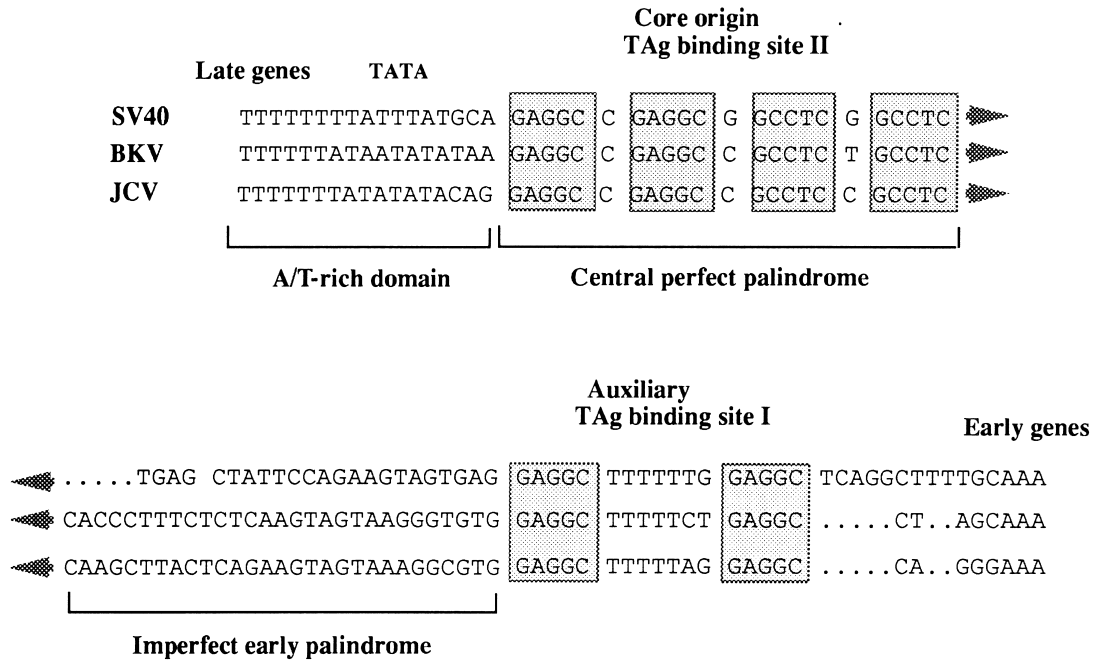

Figure 23.3 Alignment of the DNA sequence encompassing the origin of DNA replication in the non-coding genomic region of the primate polyomaviruses SV40, BKV and JCV. All sequences are given in the sense of the early coding strand. TAg consensus pentanucleotide recognition sites common to all virus strains are in shaded boxes

(Figure 23.3). Bidirectional replication takes place in the presence of the core ORI and TAg, proceeding from the ORI elements with the T antigen binding sites and terminating at a site about 180° from the initiation site. The features shared by all ORI regions are an inverted repeat on the early side, a GC rich palindrome in the centre and an AT sequence on the late side of ORI. All core ORIs contain these elements, suggesting that common mechanisms play a role in initiation of viral DNA replication. This assumption was confirmed by replication studies on the human polyomaviruses, showing that besides T antigen binding, site II and the inverted repeat are essential for DNA replication (Frisque and White, 1992). Whereas the presence of flanking sequences stimulates DNA replication, the TCR does not affect DNA replication activity directly (Daniel *et al.*, 1996). In consequence, DNA replication is initiated if T antigen is provided by the host cell, irrespective of the viral promoter activity. However, the efficiency of DNA replication directed from JCV ORI sequences is substantially lower than that of SV40 and BKV ORI. Subtle differences in the ORI sequence among

the virus species might be correlated with differential affinity of binding proteins or post-translational changes of the respective T antigen.

Transcriptional Expression

The transcriptional control region (TCR) of the human polyomaviruses is composed of a great number of different regulatory protein binding motifs (Figure 23.4). Promoter activity is mediated bidirectionally and even independently from the binding motifs by multiple interactions of transcription factors and associated cellular and viral proteins stimulating basal, cell type specific and, in response of external stimuli, induced functions of the viral promoter (Raj and Khalili, 1995). The JCV early (JCVE) and late (JCVL) promoter have been most intensively examined in recent years, and it can be assumed that the mechanisms leading to human polyomavirus expression are directed by highly related mechanisms. Therefore, for better understanding of the complicated regulatory pathways controlling human polyomavirus growth, the function of the JCV promoter is examined more

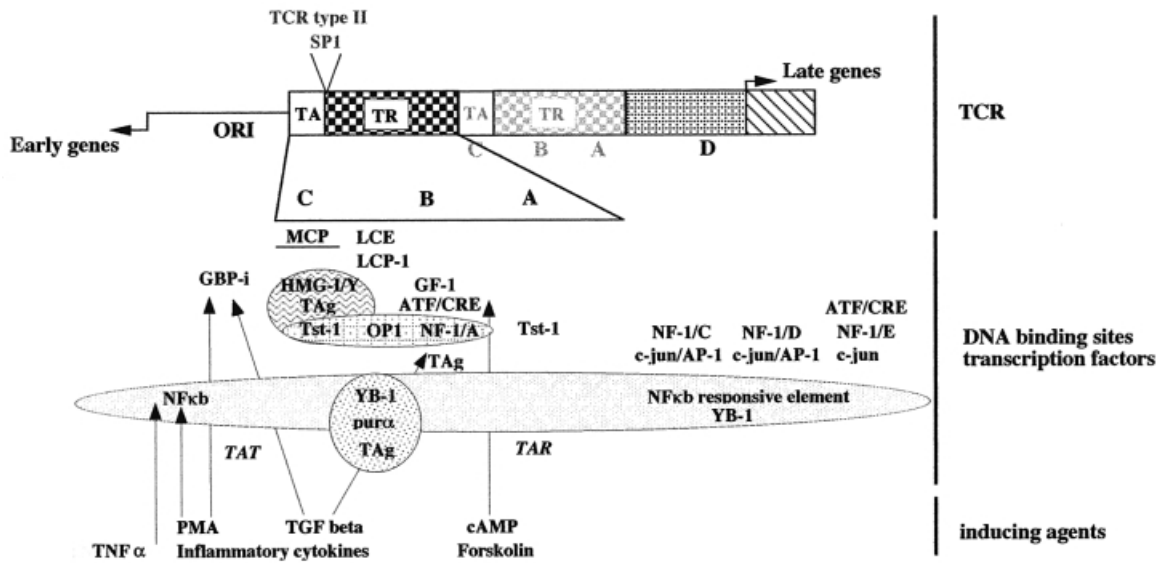

Figure 23.4 JCV TCR with protein binding sites and interaction of cellular and viral transcription factors. TCR structure of prototype JCV Mad-1 is shown between the start codons (arrows) for early and late genes. ORI = origin of DNA replication; TA = TATA box; TR = tandem repeated promoter elements; similar shading represents identical DNA sequences, see Figure 23.5 legend; A–D = dissected promoter domains; MCP = minimal core promoter; LCE = lytic control element. Binding sites and the respective proteins are indicated below the promoter domains; filled circles indicate interaction of transcription factors; *TAT*, *TAR* = HIV related transactivation domains; arrows indicate interaction of inducing agents with the respective proteins; V, position of SP1 binding site in JCV TCR type II genomes

closely. The JCV control region is artificially dissected in the ORI domain and following four TCR subdomains (A–D), in each of which a clustering of early and late interactive promoter sites is observed.

Outside of the TCR domain, on the early site of ORI, a binding sequence is located for the potent transcriptional enhancer nuclear factor κ B (NF κ B). The site increases bidirectionally transcription from the late, and to a lesser extent from the early, promoter in glial cells (Mayreddy *et al.*, 1996). NF κ B is constitutively expressed in B lymphocytes, one of the sites of JCV persistence. NF κ B can be retained in the cytoplasm by an inhibitor κ B protein. This binding can be released through stimulation by a number of agents as tumour promoters like phorbol myristate acetate (PMA) or inflammatory cytokines. It results in the transport of NF κ B to the nucleus, where the binding to the consensus DNA sites exerts activity. Upon PMA treatment both JCV promoters are responsive to NF κ B induction, leading to increased JCV activity. In addition, tumour necrosis factor α (TNF α) is able to enhance binding of NF κ B to the JCV κ B site (Atwood *et al.*, 1995). This stimulates the idea that activation of the transcriptional control *in vivo* might be dependent

on the expression of factors involved in immunologically regulated signalling pathways to modulate JCV expression.

It was shown that interference with κ B function in late gene expression decreased, but did not abolish, activity. This suggested that additional TCR elements may confer inducibility to the JCV promoter. At present the possibility that cross-communication between motifs is mediated by a 40 kDa protein complex distinct from the classical NF κ B subunits is discussed. In the presence of classical NF κ B binding proteins this complex may not effectively interact with the κ B sequence. However, if the NF κ B activators are not expressed, the 40 kDa protein may bind and downregulate JCV gene transcription. This may come into effect during the persistent state of infection.

In addition, the GRS motif within ORI might interact with the κ B motif (Raj and Khalili, 1995). GRS is similarly inducible by PMA and inflammatory cytokines. The responsive region interacts with the protein GBP-i. GBP-i is induced in a wide range of cell types, thus it could play a role in mediating JCV activation at all suspected sites of persistence. Comparable to the NF κ B class of proteins, the

GBP-i complexes probably represent a combinatorial assembly of various protein species that is changed upon induction. Duality of function could involve the basal transcriptional machinery and other transcription proteins associated with the late promoter activity. One potential factor is transforming growth factor β acting through the GRS and the NF-1 sites. In such a model the status of the viral promoter could be modulated through the GRS and variable interaction of cytokine-induced proteins. Although these cytokines might use differential signal transduction pathways for protein activation, in consequence, the nuclear milieu will contain the factors leading to expression by interaction with a promoter containing the respective contact sites.

The following domain C contains the JCV early minimal core promoter (MCP) that is constituted by the TATA box region and the immediately adjacent binding site for the transcription factor Tst-1/Oct-6, a member of the POU-domain protein family. In glial cells Tst-1 was found to be one of the permanently produced cell type selective transcriptional regulators. Both JCV promoter orientations are stimulated by DNA binding of Tst-1 in glial cells to sequence motifs involving the TATA box and overlapping in part with adjacent OP-1 and YB-1 binding sites.

Like most pou proteins Tst-1/Oct-6 is an intrinsically weak transcriptional regulator. To compensate for this weakness, Tst-1 has to rely on viral or glial cell specific coactivators. Large T antigen of JCV has been identified as a viral coactivator which stimulates the function of Tst-1 synergistically by direct interaction. The modular synergism of both proteins does not require DNA binding of JCV T antigen in the presence of a functional binding site of Tst-1. The high mobility group proteins HMG-I/Y have been discussed as cellular coactivators. Though not a transcriptional regulator by itself, HMG is believed to serve as a promoter-specific accessory factor modifying the transcriptional function. The JCV AT-rich region with the Tst-1 site provides the binding site for HMG proteins that substantially stimulate Tst-1 binding to the Tst-1 responsive element.

Tst-1 and HMG are able to activate synergistically JC gene expression, clearly indicating cooperation between the two proteins. However, the TST-1 site alone was not enough to mediate efficient cooperation. The identification of the glial cell spe-

cific late transcriptional silencer OP-1 contacting directly downstream of the Tst-1 binding site points to the possibility that cross-talk between the two sites could influence viral transcription. The OP-1 motif also interacts with the adjacent NF-1 site. OP-1 and NF-1 form a composite element that increases JCV early activity and reduced JCV late activity by interaction of common proteins with glial cell specific NF-1 protein binding (Raj and Khalili, 1995).

In addition, the poly(dA) stretch with the overlapping pentanucleotide motif differentially binds members of the LCP-1 protein family recognizing alternative DNA structures. This influences early and late promoter functions and is therefore designated as JCV lytic control element (LCE). A YB-1/pur α binding site was found in close association with the LCE element. YB-1 is a member of a gene family isolated originally from a human B cell expression library. The essential contact site is located in the C/T-rich sequence on the early strand of the LCE without affecting the adjacent NF-1 binding site. YB-1 binds to double-stranded and single-stranded DNA and activates transcription from both the viral early and late promoter. The function is attributed to both its interaction with DNA and its ability to interact with other proteins. The pentanucleotide repeat on the late LCE strand is the target for the single-stranded DNA binding protein pur α . It is associated with YB-1 early activation by cross-communication of the proteins on the LCE, mediating reduced or increased binding to YB-1.

Although TAg has no binding capacities to LCE sequences, the close association of YB-1, pur α and TAg and the complexity of binding events suggest that the interplay is important for a broad spectrum of different functions during the JCV life cycle. The current model for the involvement of pur α and YB-1 in TAg-mediated transition of the early-to-late promoter activity of JCV gene transcription is based on the following findings.

Pur α increases early promoter activity with minor effects on the late sequences, TAg increases late activity considerably, and YB-1 elevated basal activity on the early and late promoter with a higher rate in the late phase. Increasing concentrations of TAg results in a gradual decrease in pur α early enhancement. Therefore it is possible that pur α might be involved in a negative feedback mechanism for downregulation of JCVE during the late phase of infection.

In contrast to the early expression, cooperative action of pur α and TAg leads to interference of pur α with the TAg late stimulatory effect, suggesting that pur α and TAg exert antagonistic effects on each other's transcriptional activity. The mechanism by which the two regulators influence each other's activities is not yet clear; however, TAg may destabilize indirectly the association of pur α with the LCE. In this respect, TAg might cause dissociation of pur α from the LCE by increasing the rate of YB-1 binding.

From these findings it was proposed that at the initial phase of infection strong binding of pur α to the LCE preferentially stimulates transcription of the early genome. As the lytic cycle proceeds, the composition of DNA-protein complexes in the LCE is altered. The increasing level of TAg facilitates YB-1-mediated dissociation of pur α from the pentanucleotide repeat by stabilizing the association of YB-1 with DNA. Removal of pur α from the LCE results in a substantial decrease in early promoter activity. At the same time YB-1-associated pur α release of the late promoter allows T antigen to enhance the expression during the late phase of infection.

The B domain in the early orientation contributes positively to expression in glial cells and is also important for transcriptional activation of JCVL genes. The central motif is responding to glial factor 1 (GF-1) (Chen *et al.*, 1997). GF-1 protein expression is most abundant in brain tissue. Interestingly, the amount of GF-1 is higher in kidney cells than in other cell types. Therefore it is considered that the level of GF-1 in kidney cells may be responsible for the ability of JCV to replicate in urogenital tissue. Binding to the GF-1 site stimulates transcription from the JCVL promoter and to a lesser degree from the JCVE promoter.

Pronounced high affinity NF-1 binding sites (NF-1 A/B) are located just upstream of the A/T rich region. Three more NF-1 sites (C, D, E) are found in domain A and further into the late region. Three overlapping binding sites for nuclear factor Jun are associated closely. On the latter half of NF-1 site A/B a consensus sequence similar to that of activation transcription factor ATF or the cyclic AMP-responsive element (CRE) and, overlapping NF-1 site E, a sequence with partial homology to ATF/CRE sites is localized (Kumar *et al.*, 1996b, 1996c). NF-1 site D coincides with a site resembling the sequence for the activator protein AP-1. Inter-

actions at the binding sites involve NF-1 or NF-1-like factors, ATF/CRE-related factors and Jun-related (AP-1-like) factors. Isolated binding sites do not mediate activity, suggesting an essential role for the surrounding binding sites and interactions of related proteins for the activation process.

NF-1 sites A/B are involved in basal as well as in glial cell specific modulation. This discrepancy was explained recently by the detection of a glial cell-specific NF-1 form that considerably enhanced transcription from the JCV promoter (Sumner *et al.*, 1996). It became clear that the level of transcriptional activity and specificity of the NF-1 sites is due to a homodimeric/heterodimeric nature of different NF-1 molecules, and to the combinatorial interaction of NF-1 with adjacent proteins. Apart from the prominent activity conveyed by NF-1 on to the JCVE, the sites are involved in JCVL cell-specific activation by TAg transactivation (Kumar *et al.*, 1996a).

Cell-specific activity in glial cells includes CRE. JCVE expression is increased substantially by the second messenger cAMP and forskolin. Activity is mediated by a CRE binding protein (CREB) and is not influenced by the NF-1 site. However, this does not exclude the possibility that the binding of other proteins to CRE may modulate expression without directly interacting with JCVE sites. Additionally, a glial cell-specific modification of CREB might be responsible for activation.

Thus a significant contribution to the enhanced glial cell-specific expression of JCV appears to be made by inducible transcription factors interacting with unique motifs on the JCV promoter. Importantly, the mechanisms of induction for the factors are through different signal transduction pathways. This combination allows a highly flexible JCV transcriptional response to a large number of environmental signals.

At present, in domain A two potential promoter elements are identified, a transactivator element associated to HIV TAR homologous sequences and Tst-1 binding sites. The D domain is localized close to the start codon of the late proteins in the leader of the late RNAs. It spans binding sites for cellular proteins NF-1, c-jun, YB-1 and a NF κ B responsive region (Raj *et al.*, 1996). YB-1 exhibits the ability to modulate basal and activated levels of transcription of JCVL through its influence on p65 on the NF κ B site. This points to a potential role for YB-1 as a transcriptional coactivator for regulation from the

NF κ B site. The YB-1 binding site on the B domain does not account for such pronounced effects, thus the D domain represents probably the more optimal site for interaction of YB-1 and NF κ B/rel subunits.

NF κ B/rel subunits modulate JCV late promoter activity from the D domain, revealing an extensive duality of NF κ B/rel-mediated effects. The subunits appear to have a mutually antagonistic function in terms of their transcriptional activity from either the D domain or the NF κ B site. Basal uninduced transcription appears to be positively regulated by p50/52 from the D domain, whereas induced transcription is positively regulated by p65 from the NF κ B site. At present, it appears likely that the interplay between NF κ B subunits and the D domain is dependent on direct and specific interaction of YB-1 and the NF κ B/rel subunits influencing each other's binding capacity to their respective target DNAs. Since each of the NF κ B dimers can interact potentially with the NF κ B site, multiple levels of regulation can be mediated by the complex interactions of NF κ B/rel subunits. This provides the virus with an exquisite control mechanism over constitutive and induced NF κ B activity.

Heterologous Transactivation of Virus Transcription

Additionally to activating effects by induction of cellular transcription factors, viruses influence JCV expression through the direct or indirect interaction of a heterologous gene product. In general, transactivation of a gene product can occur at any step in the synthesis beginning with the initiation of transcription and ending with post-translational modifications. In the case of JCV enhancement, promoter activity and DNA replication appear to be affected.

The HIV encoded transregulatory protein Tat has been found to be a potent activator of the JCL promoter. Tat is a transcriptional activator and an essential component for the establishment of a productive HIV-1 infection. Activation of the HIV promoter is mediated by the transacting responsive region (TAR). In the JCV promoter at least two responsive elements, the TAT element in the ORI domain and the TAR element, were identified, one of which exhibits substantial sequence homology with the critical region of the HIV-TAR (Remenick *et al.*, 1991). Transactivation of JCVL by Tat occurs

in a cell type-specific manner. Primary effect of Tat on JCVL expression is to enhance the rate of transcription, suggesting that interaction between HIV-1 and JCV in infected cells may facilitate JCV growth by stimulation of viral late gene expression.

Interaction of *Human cytomegalovirus* (CMV) with JCV expression has been studied less intensively (Heilbronn *et al.*, 1993). In this case replicating CMV increased JCV DNA replication in non-permissive cells. Although the CMV effector protein was not characterized, it is likely that DNA replication is affected indirectly. Since early expression of T antigen is indispensable for JCV DNA replication, initial steps might involve transactivation of the early promoter by an unknown CMV effector and subsequent expression of T antigen.

The mechanisms of human polyomavirus transactivation by heterologous viruses are not understood at present. However, the increasing number of patients infected with the human immunodeficiency virus (HIV) who have active polyomavirus infections argues for a potential role of concomitantly infecting viruses for the activation of polyomavirus infections in men.

Genomic Heterogeneity of Viral Subtypes

JCV DNA populations from PML brain tissue exhibit regularly a remarkable genomic homogeneity within one patient. However, analysis of JCV isolates from different individuals revealed that a large number of JCV subtypes exist. Although genomic analysis of BKV is rather limited (Negrini *et al.*, 1991; Jin *et al.*, 1993), similarly diverging TCRs have been observed, pointing to a more general role of genomic heterogeneity among the polyomaviruses (Dörries, 1997).

Throughout JCV genomes numerous single base changes can be observed and the TCRs exhibit extensive structural differences. Single base mutations in coding genes do not affect the reading frames and most are silent, having no effect on the amino acid composition of the proteins. The biological significance of the changes remains uncertain, as protein alterations do not apparently influence viability or cell specificity of viral subtypes. Among all viral genes, VP1 shows the greatest degree of variation, whereas the agnogene is the most

conserved part. The clustering of mutations on the terminal end of VP1 and TAg proteins provides the tool for V-T subtyping of JCV genotypes in different regions of the world and can be used for virus transmission studies.

At present, by creation of a phylogenetic tree from isolates all over the world, a number of major V-T genotypes are characterized and assigned to different geographical regions. Three separate JCV genotypes type 1 (EU) and type 2 (B1) are defined as European/American types. Since type 2 was traced in a wide region extending from Europe to western and eastern Asia, it can also be defined as European/Asian type. Additional types (3, Af2) were found mainly in African states and in Afro-Americans. A fourth type was found in the USA and is probably a natural recombinant of the European and the African type, thus being probably representative of migrating populations. Although prevalent subtypes vary considerably in the Asian region, most territories are dominated by subtypes Cy and My detected previously in Japan (Sugimoto *et al.*, 1997).

The changes within the non-coding region of JCV are used for classification of three major TCR subtypes: class I, class II and the archetype (Figure 23.5). All the major JCV variants isolated so far can be grouped into these basic types. The extensive heterogeneity of the JCV TCR gave rise to the hypothesis that the rearrangements might be involved as a virulence factor in the pathogenic process. It was assumed that JCV TCRs may change from an attenuated persisting subtype in peripheral organs to a virulent virus type growing efficiently in glial cell (Dörries, 1997).

The variable TCR elements are constructed of conserved segments with a high degree of sequence conservation that can be deleted or duplicated and rejoined to new units in individual subtypes. The junction between these domains are variable in length and used preferentially as breaking regions, thus serving as a source of rearranged sequence pattern. Three major patterns are found: type I DNA contains two TATA sequences by inclusion of the TATA box in the repeated element; type II DNA has only one TATA sequence and a 23 bp insertion which includes a potential enhancer core sequence followed by extensively rearranged repeats; the archetype with a single promoter element and a 66 bp insertion does not exhibit any major repetitions.

Genomic comparison of JCV populations in affected central nervous system (CNS) tissue and persistently infected renal tissue of the same PML patient revealed presence of homogeneous populations of highly related subtypes at both sites of infection. However, in contrast to the brain-derived virus type with duplicated promoter elements, the kidney-derived virus exhibited an archetype control region (Loeber and Dörries, 1988). This provided evidence that a peripheral virus type may invade the CNS during persistence, and duplicated promoter elements may be generated subsequently anew in each host. The assumption was evaluated by analysis of JCV DNA populations in PML patients. Presence of heterogeneous genomes could only be confirmed at a low rate in the active stage of disease. As a possible explanation it was considered that TCR changes might be a rather isolated event, or could be associated with the early stages of disease. Alternatively, rearrangements might be generated at activated states during persistent infection. In this case, the more virulent subtypes in heterogeneous TCR populations might outgrow others, leading to the homogeneous populations found in PML tissue.

Activation of polyomavirus infection is observed most often in impairment of the immune system. Analysis of JCV genomes in such individuals revealed mostly homogeneous TCR populations, including pregnant women, renal transplant patients from Japan undergoing immunosuppressive therapy, Scandinavian and American AIDS patients. Although a minor group carried virus populations with duplicated rearranged TCR forms, the populations consisted predominantly of single promoter elements. Obviously, immune impairment does not play a major role in the induction of rearrangements from the archetype structure. The analysis of JCV TCR types in non-immunosuppressed and healthy individuals from different countries revealed that human populations carrying dominantly single promoter elements exist beside others discerning JCV PML-type TCRs in persistent infection (Kitamura *et al.*, 1994b).

In addition, comparison of TCR types in persistently infected kidney, brain and peripheral blood cells revealed similar distribution of TCR types and no association with specific tissues. From this finding it can be assumed that the generation of JCV subtypes is not associated with cell specificity. The low prevalence of variant TCR types in almost all

JCV TCR type I

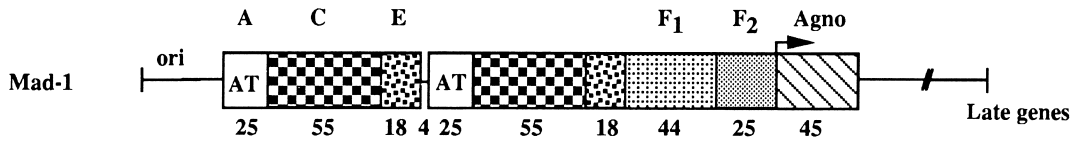

JCV TCR type II

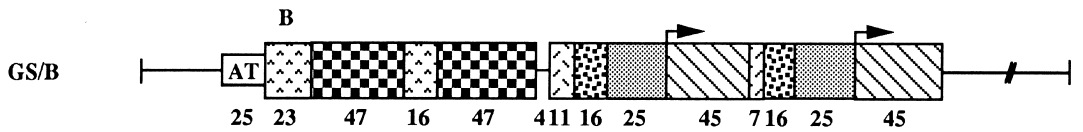

JCV Archetype

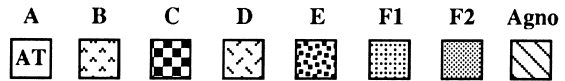
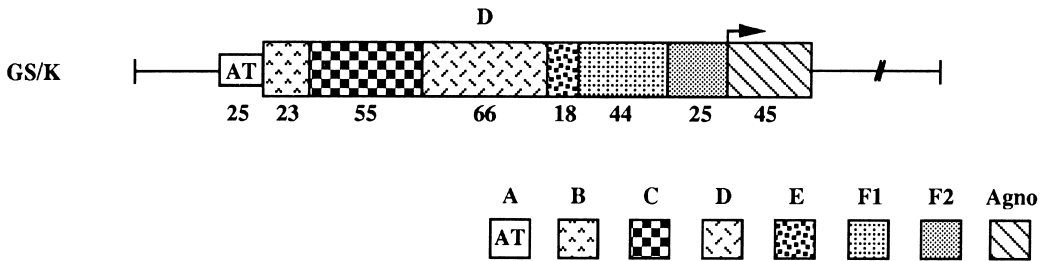

Figure 23.5 Structure of JCV TCR subtypes. JCV TCR subtype I: American JCV prototype Mad-1. TCR type II: European JCV prototype GS/B. Archetype: European isolate JCV GS/K. The sequence is divided in seven boxed segments (A, B, C, D, E, F1, F2) differing in number and/or length. A represents the TATA box. The initiation codon for the putative agnogene is indicated by an arrow. Segment length is given in base pairs; AT = TATA box; ori = origin of DNA replication

patients groups points rather to the existence of stable TCR subtypes in the human population that might be less sensitive to rearrangements than to a high rate of rearrangements in all individuals (Elsner and Dörries, 1998).

On the basis of these findings, it is essential to answer the question of the transcriptional activity of subtype control regions (Ault, 1997). Initial experiments point to a more complicated situation than assumed by the DNA sequence analyses of JCV promoter elements alone. In contrast to all assumptions, it was found recently that the rate of early transcriptional activity mediated by duplicated TCRs can be similar to that of single promoter structures. It was also confirmed that the overall cell type specificity of individual subtypes is not affected by structural changes (author's observations). Therefore TCR heterogeneity of the human polyomaviruses appears to be a determining factor of reproductive growth rate, but is most probably not related to the induction of disease.

Interestingly, in a number of PML patients JCV V-T European/American genotype II genomes linked to double repeat PML type TCRs were described (Agostini *et al.*, 1997a, 1997b). In consequence, it was asked whether a specific genotype might constitute a pathogenic strain. V-T genotypes 1 and 2 are both linked to archetypal and PML-type TCR elements, and were both isolated from PML and persistently infected individuals. Although at present no archetype genome has been described as the only variant in PML cases, from the relationship of archetype and PML-type regulatory regions it is conceivable that PML-type JCV TCRs have been generated from single promoter elements. Since geographical clustering of JCV type II genomes cannot be excluded, it remains to be evaluated further whether one of the major JCV V-T types is associated dominantly with PML.

Table 23.2 Human polyomavirus-associated diseases

Patients	JCV infection		BKV infection	
	Disease	Cell type involved	Disease	Cell type involved
<i>Immunocompetent</i>	None observed	—	Mild respiratory disease Mild pyrexia Transient cystitis	—
<i>Immunocompromised</i>				
Urogenital system	None observed	—	Ureteral stenosis Haemorrhagic cystitis Tubulonephritis	Epithelial cells Fibrocytes
Lung	None observed	—	Interstitial pneumonitis	Epithelial cells Pneumocytes Endothelial cells Fibrocytes
CNS	Progressive multifocal leukoencephalopathy (PML)	Oligodendrocytes Astrocytes Mononuclear cells B lymphocytes	Subacute meningo-encephalitis	Epithelial cells Fibrocytes Endothelial cells Astrocytes Ependymal cells

States and Target Organs of Human Polyomavirus Infection

Primary Infection

Primary contact with the human polyomaviruses occurs usually during childhood or early in adulthood, leading to lifelong infection in the immunocompetent host. An association of primary BKV infection with mild respiratory tract disease, mild pyrexia and transient cystitis is discussed occasionally, but generally the course is asymptomatic (Table 23.2). Viruses undergo normally an initial replication cycle in cells proximal to the site of entry and prior to viraemia. The site of JCV entry is not yet localized. In the case of BKV, the presence of viral DNA in nasopharyngeal aspirates and tonsils pointed to the oropharynx as the initial site of infection. Nevertheless, cell types supporting initial replication and routes of virus distribution remained undefined. Viraemia is thought to occur, based on the finding that virus reaches sites of persistence very early in infection (Figure 23.6).

Despite the knowledge that JCV infection is widespread in the population, almost nothing is known about the way it is transmitted in humans. Studies in and around Tokyo suggest that population density and environmental conditions may affect the transmission of JCV. One route of transmission was elucidated by tracing JCV subtypes in

Japanese families in which both parents and children excreted JCV in their urine. Typing of JCV genomes in individual family members revealed the presence of different viral subtypes (Kitamura *et al.*, 1994a; Sugimoto *et al.*, 1997). In about 50% of persons the JCV strains originated from infection outside families. Children have many opportunities to come into contact with urinary JCV infection, suggesting urinary excretion as a prominent source of JCV in the human population.

Persistent Infection

The discovery of BKV came from the observation of cytological abnormalities in the urinary sediment of a kidney transplant patient. Later it became clear that BKV is a urotheliotropic virus affecting epithelia of the renal calyces, renal pelvis, ureter and urinary bladder (Shinohara *et al.*, 1993). Similarly, JCV was detected in the urinary tract of immunosuppressed individuals and pregnant women. Polymerase chain reaction (PCR) analyses suggest that the number of affected individuals parallels closely the percentage of persons with serological evidence for contact with JCV. Thus the kidney is obviously an essential site of human polyomavirus infection (Arthur and Shah, 1989).

JCV DNA was detected in the kidney of two children with combined immunodeficiency disease who developed PML during primary JCV infection.

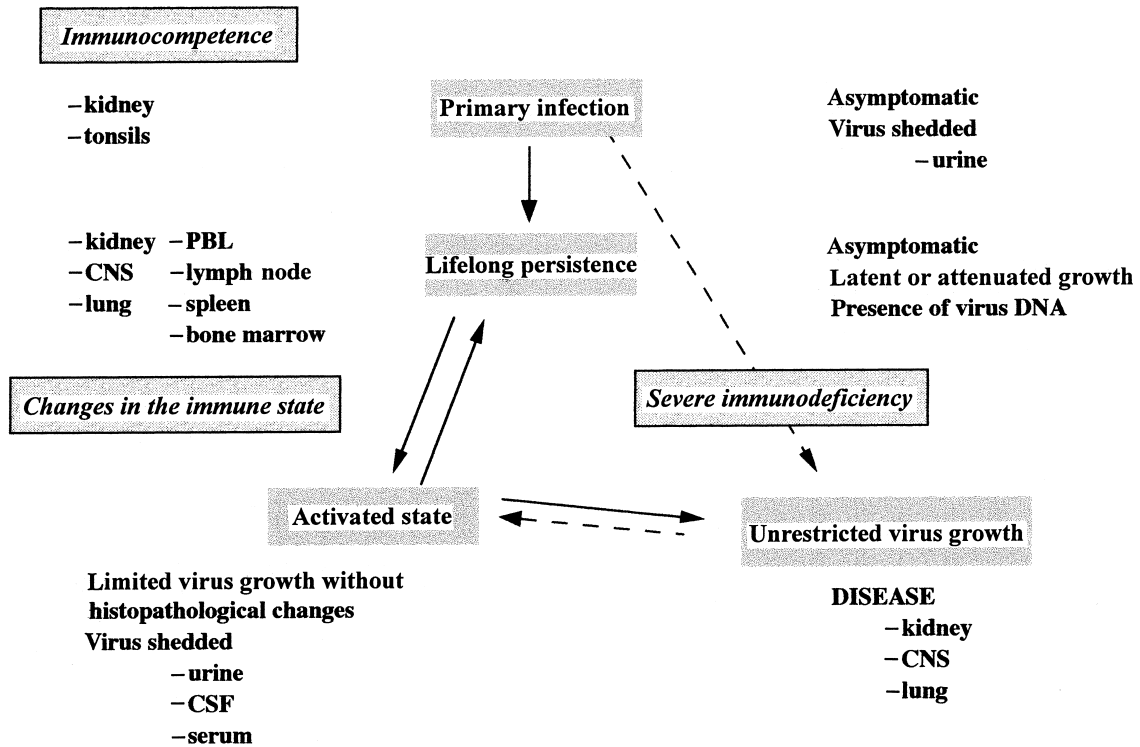

Figure 23.6 Course of human polyomavirus infection

The presence of JCV DNA in spleen, lymph node and lung cells support the thesis that JCV persistence in individual organs is established most probably during primary infection. Although repeated detection of JCV DNA in ureters of non-immunosuppressed patients characterized the renal tract as a site of persistence, the higher detection frequency in the renal medulla indicates that the epithelial cells lining collective tubules are the major target cells. The presence of JCV in urothelial sediments suggests that they are more often subject to activation processes than other cells in the renal tract.

In the tonsils, BKV DNA was found to be associated specifically with the lymphoid tissue of Waldeyer's ring, thus indicating involvement of lymphocytes in human polyomavirus infection. Lymphoid interaction of BKV was supported further by a stimulatory effect of virus infection on human lymphocytes in cell culture, and the demonstration of specific BKV receptors on the surface of peripheral blood cells by the rosetting technique. Interestingly, only a small number of cells carried receptors for BKV. They were considered as B lymphocytes.

Nevertheless, virus protein expression was restricted to less than 1% of the cells, thus pointing to an attenuated replication in lymphocytes. Although the virus is able to attach and penetrate into monocytes, there was no expression. Therefore monocytes may be involved in the degradation rather than in the replication of engulfed virus particles in natural infection. The presence of BKV DNA in leucocytes of persistently infected individuals confirmed involvement of BKV in peripheral blood infection (Dörries, 1997).

Haematogeneous spread of JCV to the CNS in PML had been suspected in early reports because of the exceptional multifocal distribution of JCV foci in PML. Occasional involvement of spleen and lymph nodes and the finding of virus particles in lymphocytes in a child with measles virus infection led to the assumption that lymphoid cells might be involved regularly in virus spread and establishment of persistent infection. This was confirmed by demonstrating JCV DNA and capsid protein in a small number of mononuclear cells of bone marrow and spleen in PML/AIDS patients. These cells were characterized as B lymphocytes by cellular markers.

The presence of JCV-infected mononuclear cells in perivascular parenchyma and in Virchow–Robin spaces may support further the haematogeneous route of entry of JCV into the brain. In other reports, only occasionally were monocytic cells reported in PML brain, thus the question whether glial cell infection originates from passage of virus through lymphocytes to parenchymal glial cells or by another mechanism remains open.

Although infection rates in peripheral lymphocytes of PML patients were the highest, the virus is found consistently during periods of immunocompromise at rates of about 38% in HIV patients without evidence of PML. Detection of full length JCV DNA in peripheral blood from healthy individuals added further support to the idea that the human polyomaviruses are lymphotropic in nature. *In situ* hybridization confirmed common infection of human peripheral blood lymphocytes (PBLs) and experimental evidence demonstrating interaction of JCV with human B lymphocyte cell lines argues for the involvement of these cell types in natural infection (Dörries, 1997).

Summarising the data, human peripheral leucocytes are obviously target cells for asymptomatic polyomavirus infection in almost all adults by the age of 20 years. Therefore it is likely that polyomaviruses are able to establish a persistent infection in lymphocytes during primary infection or early in persistence. The amount of virus-specific DNA in the cells is regularly lower in healthy persons than in immunocompromised patients. This is consistent with the finding that persistent polyomavirus infection is restricted to a few virus genomes and to a low expression rate, if there is any. Nevertheless, the number of viral DNA molecules increases occasionally, probably under impairment of the immune system due to a timely restricted activation in healthy persons. Similarly, the higher incidence of virus DNA in multiple specimens of patients with lymphoproliferative disorders, and the finding of elevated virus specific antibody titres in the elderly, in pregnancy or in patients with tumours, point to lymphocytes or their precursors as target cells for virus persistence and continuous activation. The suggestion that infected B cells or their precursors act as a reservoir for the virion in the diseased brain might be questionable; however, it is conceivable that JCV-infected lymphoid cells may act as a vector for JCV CNS invasion and dissemination during persistent infection (Gallia *et al.*, 1997).

Although JCV is demonstrated easily in disseminated areas of PML autopsy material, the question of whether PML results from cytolytic invasion of the CNS under severe immunosuppression or as a consequence of a preceding persistent infection is under discussion (Dörries, 1997). In early studies employing Southern blot analysis, *in situ* hybridization or immunochemistry virus DNA or protein had never been detected in the CNS. However, application of the PCR revealed frequent JCV infection in the brain of patients without evidence of PML. In contrast to fetal brain tissue, JCV DNA sequences were present in about 30–70% of adults, depending on the experimental groups. JCV obviously has no topographical preference, because dissemination of viral DNA is similar to that in PML tissue. Analysis of the physical state and genetic complexity of virus sequences resulted exclusively in unique, full length, episomal JCV genomes. Compared to thousands of genome equivalents present in affected PML samples, the amount of virus specific DNA in asymptomatic individuals is much lower, with an estimated range of 1–100 genome equivalents per 20 cells. Thus persistent polyomavirus infection in the CNS is probably restricted to isolated cells and most likely represents chronic infection and not early stages of disease (Dörries, 1998).

The findings prove that human peripheral polyomavirus infection is associated with subclinical virus entry into the CNS, probably long before the development of clinically overt PML. Virus activation may lead to an increased number of infected cells and a higher detection frequency in cases of severe immunosuppression, in patients with malignant disease and in the elderly. This is in agreement with the assumption that impairment of immune competence favours involvement of the CNS in polyomavirus infection.

Concomitant JCV and BKV Infection

Double infection of JCV and BKV was established, particularly after organ transplantation, in HIV-infected patients, in pregnancy and in a small number of immunocompetent individuals, by urinary excretion or antibody rise against both viruses. Molecular detection of JCV and BKV specific DNA confirmed that concomitant persistence frequently occurs in kidney tissue. Extensive homologies of the genomic structure, similarities of virus spread and

state of infection started very early the discussion on possible other sites of dual JCV and BKV infection. After PBLs were found to be a target of polyomavirus infection, the presence of JCV and BKV DNA in blood cells of the same individual was not astonishing. A high rate of concomitant infection was evidenced molecularly in healthy and immunosuppressed individuals. As JCV protein expression was detected in lymphoid cells of immunosuppressed patients, and BK virus is able to replicate in lymphocytes *in vitro*, it can be assumed that both human polyomavirus infections are activated periodically in persistently infected PBLs.

Although BKV was not expected to invade the CNS at a high rate, cell specificity of BKV is less stringent than that of JCV, therefore several laboratories sought for double infection in the CNS. Cloning from CNS gene libraries and PCR revealed frequent BKV dissemination to the brain. Indirectly, BKV infection of the human CNS was confirmed by the report of a subacute BKV-associated meningoencephalitis in a patient with the acquired immune deficiency syndrome (AIDS). Physical state and genetic complexity of BKV genomes were comparable to that of JCV DNA; however, low concentration of brain-derived BKV specific PCR products suggests a considerably lower activity of BKV in the CNS than that of JCV. The detection of amplification products belonging to both polyomavirus species gives strong evidence for concomitant polyomavirus infection in the CNS. Additionally, it demonstrates that not only JCV but also BKV is neurotropic in the human host, and establishes frequently persistent CNS infection.

The rate of adult healthy individuals found positive for concomitant infection was astounding, but the data correspond to recently discussed rates of infection with BKV of almost 100% by the age of 10, and JCV reaching more than 90% in adulthood. Therefore the number of positive cases probably reflects the true incidence of polyomavirus infection in the European population.

Asymptomatic Activation of Infection

Transient polyomavirus viruria probably occurs at the time of primary infection. However, in most instances presence of virus in the urine is due to activation processes. Activation of infection in the healthy was assumed to be related predominantly to alterations of immunocompetence in the older

age group. Recently, it was reported that JCV DNA was present in the urine of about 30% of American and 60% of Japanese and European healthy individuals. The incidence of excretion was dependent on age, with lower rates in the young and then gradually increasing in older age. Because of the high frequency of JCV excretion throughout adulthood, as detected by PCR, it is suggested that in most healthy adults JCV infection is not in a latent but in a productive persistent state. Since all other data were accumulated by less sensitive methods, it is conceivable that a basic virus expression is maintained permanently at an attenuated level.

Pregnancy is among the most common conditions that have been linked to viral activation. Incidence of viruria, at a level detectable by periodic cytological examination, was about 3–7% for JCV and 15% for BKV at some time during pregnancy. The onset of viruria was late in the second trimester and during the third trimester. In excretors, virus shedding, once it was established, continued intermittently to term and then ceased in the postpartum period. The detection rates are according to studies on high or increasing antibody titres in a comparable population, and therefore represent probably the true rate of activated persistent infections.

Renal transplant recipients experienced viruria at a higher rate ranging from 9 to 19%, compared to a rate of 2.4% in pregnant women with similar detection sensitivities. Duration may be over a month, even to years. In bone marrow transplant recipients almost all viruria was due to BKV, with an incidence of up to 50% in the post-transplant period.

Although these findings point to a significant role of the immunosuppressive state in the activation of polyomavirus infection in the kidney, examination of HIV patients revealed no significant changes in virus activation compared to a comparable group of non-immunocompromised controls; thus an enhancement of urinary excretion by HIV-induced immunosuppression was not detectable. Similarly, PML patients do not necessarily have concomitant JCV viruria. Aggressive chemotherapy does not increase virus frequency, and in other immunosuppressive diseases viruria can be intermittent, with sparsely distributed infected cells in cytologically positive urine, pointing similarly to a rather low rate of virus production (Arthur and Shah, 1989).

Activation at other sites of persistent infection is less well recognized. This is due to the attenuated growth of virus products in asymptomatic transient

activation states and to the low virus load in persistently infected healthy individuals. Although persistent infection in lymphocytes appears to be a common event, activation can only be deduced so far from the presence of higher amounts of virus DNA in PBLs of immunologically impaired individuals. In addition, in HIV-PML patients mononuclear cells in PML tissue were characterized expressing JCV specific proteins. Thus it appears likely that JCV infection in lymphocytes is activated under as yet unknown circumstances (Gallia *et al.*, 1997).

The presence of JCV DNA in brain tissue of immunocompetent patients in a distribution comparable to that in PML, and increasing incidence of detection with age and in patients with malignancies, point to viral activation in the CNS. The detection of virus specific protein in a limited number of glial cells in non-PML brain, and PCR amplification of JCV specific products in CSF of the same patient groups, further argue for asymptomatic JCV activation in persistently infected brain tissue (Dörries, 1997).

If the current knowledge is summarized, it must be assumed that activation of BKV and JCV infection is species specific and occurs as a result of immune system alterations induced by pregnancy, older age, malignant tumour growth or AIDS. Some of these individuals may undergo sporadic activation as a consequence of their genotypes or of incidental transactivation events by other viruses. In general, however, virus growth is dependent on the impairment of immunological control resulting in differentially regulated activation patterns in infected organs. Although related mechanisms are unknown so far, the higher frequency of deficiencies correlated with T cell function in PML patients points to deficient cellular immunity as a major virulence factor.

Polyomavirus-Associated Diseases

Activation of human polyomavirus infection may either represent transient asymptomatic events or pathological processes. The induction of fatal disorders, however, is observed almost exclusively under long-lasting severe impairment of the immune system. BKV is associated predominantly with urogenital tract diseases (Arthur and Shah, 1989). Mild clinical courses are reported in primary BKV infection, whereas cystitis and tubulonephritis are

rather associated with persistent BKV infection. In immunological deficiency BKV is suspected of causing graft rejection and renal dysfunction. Virus-associated pathogenic effects are observed in ureteral stenosis as a late complication of renal transplantation, and in haemorrhagic cystitis in bone marrow transplant patients. After BMT BK viruria is detected often during episodes of cystitis; however, it is not yet known to what extent virus growth or therapeutic intervention is the cause for the tissue damage observed.

The strongest evidence of BKV-induced systemic and CNS disease comes from an AIDS patient (Vallbracht *et al.*, 1993). Histopathological evaluation revealed association of BKV with affected lung, kidney and CNS tissue. The major pathological findings were a tubulointerstitial nephropathy, an interstitial desquamative pneumonitis and a subacute meningoencephalitis. In the kidney, alterations consisted principally of focally accentuated tubular necroses. Virus products were detected in epithelial cells along the entire nephron. Alterations in the lung were characterized by intra-alveolar aggregates of desquamated pneumocytes. Virus products were detected in exfoliated pneumocytes and in epithelial and smooth muscle cells of the bronchioli. Occasionally, isolated endothelial cells in the lung carried virus protein. A common feature in both organs was focal interstitial fibrosis with a mild inflammatory response. Whereas fibrocytes were infected with virus, inflammatory cells were free of virus products.

In the CNS no pathological changes apart from mild inner atrophy have been described. Thickened fibrotic leptomeninges were infiltrated loosely by mononuclear cells, indicating chronic inflammation. In the cortex and adjoining white matter oedematous tissue alterations were found. Reactive astrocytes were localized in the outer layers of the cerebral cortex. The ventricular system exhibited focal degeneration of its ependyma and spongiform destruction of subjacent brain tissue. The choroid plexus revealed fibrosis of the stroma and atypical epithelial cells. In some areas, necrosis and exfoliation of the plexus epithelium occurred. Small infiltrates were seen in association with the lesions. The dominant target cells of BKV infection were fibroblasts of the loose reticular connective tissue, endothelial and smooth muscle cells of blood vessels, astrocytes and infiltrating macrophages in pons and medulla oblongata. Epithelial cells in the choroid

plexus and astrocytes of the subependymal brain tissue were additionally infected. Interestingly, the only glial cell type involved in BKV-associated central nervous system disease was the astrocyte, whereas the oligodendrocyte and nerve cells were not affected. The large number of cell types involved in BKV infection *in vivo* demonstrates the broad BKV cell specificity and points to a greater relationship of BKV to SV40 than to JCV. The detection of a BKV-associated disease affecting kidney, lung and the CNS confirms the involvement of those organs in BKV persistence and is in line with the persistence of BKV DNA in brain tissue of healthy individuals.

In contrast to BKV, JCV-associated disease was never observed in the urogenital tract or in the lung. The only and most prominent disease associated with JCV is the CNS disorder PML (Zu Rhein, 1969; Walker and Padgett, 1983; Berger and Concha, 1995). Although SV40 was described as the cause of PML in three American and Japanese patients, it later became clear that JCV was most probably the only agent responsible for the disease.

PML is a degenerative demyelinating disorder occurring as a late complication of pre-existing systemic diseases that impair immunological competence. Prior to the AIDS era, in about half of the cases malignant proliferative diseases were the dominant basic disorders in PML (Table 23.3). Nowadays, a steadily increasing number of cases is associated with AIDS. Calculation of PML rates vary at between 5% and 20% of AIDS patients. A higher frequency of PML can also be observed under immunosuppressive therapies. Several years of treatment precede PML in such diseases as rheumatoid arthritis, chronic asthma, sarcoidosis, lupus erythematosus, chronic polymyositis or renal transplantation. The duration of disease after onset of neurological symptoms is described as having an average of 4–6 months; however, there are cases with more than 12 months or so, with an intermittently progressive or subclinical course over the years.

The onset of PML is often insidious. In the earliest manifestation, multiple pinhead-sized demyelinating lesions are described beneath the cortical ribbon (Table 23.4). New small foci are being added continuously in neighbouring tissue as growth centres of new lesions. This concept of the histological evolution of the disease is supported by the clinical evolution: the onset might be gradual

Table 23.3 Causes of JCV activation and induction of PML prior to the AIDS epidemic

Conditions associated with	
Activation of persistent infection	PML (% of cases ^a except AIDS)
Age	None
Inflammation	None
Pregnancy	None
Diabetes	Rare
Transplantation	Rare
Carcinomatous disease	2.2
Myeloproliferative disease	6.5
Granulomatous/inflammatory disease	7.4
Immune deficiency states	16.1
Lymphoproliferative disease	62.2

^aBrooks and Walker (1984).

Table 23.4 Development of PML lesions

I Early lesion

Altered oligodendrocytes in areas of demyelination
 nuclei enlarged (2–3 ×)
 regular chromatin pattern is lost
 nuclei tint deeply with basophilic dyes
 irregular basophilic nucleic inclusions
 Seldomly activated pleomorphic microglia
 Pinhead size (mm) beneath the cortical ribbon

II Aging lesion

Reduced number of altered oligodendrocytes in the centre of demyelination
 Shrinkage of nuclei at the rim of lesions
 Widely distributed larger foci with coherent tissue

III Late lesion

Altered oligodendrocytes at the peripheral advancing zone surrounding the area of myelin loss
 In the centre
 very sparse or absent oligodendrocytes
 singly scattered reactive hypertrophic astrocytes
 giant astrocytes in mitosis
 astrocytes resembling cells in pleomorphic glioblastomas forming
 irregular necrotic patches (cm)

but each new functional impairment becomes progressively more severe. Once clinical signs appear, the disease usually progresses steadily. Early neurological symptoms regularly indicate multiple disseminated lesions in the brain. The extent and topography of lesions correlate well with the duration and symptomatology of the illness.

The pathognomonic feature of the disease is the striking alteration of oligodendrocytes in all lesions. Oligodendrocytes are located in the peripheral rim

surrounding the zone of myelin loss. The central area is composed of reactive astrocytes, including giant cells in mitosis, and astrocytes resembling malignant cells of pleomorphic glioblastomas. Infection of neurons, ependymal or endothelial cells has never been convincingly demonstrated.

The basic cause of tissue destruction is a cytolytic JCV infection of the oligodendrocyte. Destruction of these cells results in loss of myelin, tissue breakdown and impairment of brain function. Infected oligodendrocytes mediate highly effective virus growth in the range of more than 10^{10} virus particles per gram of tissue. Viral expression products and virions are found in nuclei and cytoplasm of the oligodendrocytes. Bizarre astrocytes may contain JCV; however, the question of whether astrocytes may support actively infection is not yet answered. On the grounds of the morphological changes and occasional reports on intracellular virus particles, it is considered that astrocytes may represent a semipermissive cell type mediating attenuated JCV expression, or being sensitive to virus transformation.

In contrast to classical PML, in the AIDS patient inflammatory reaction with perivascular mononuclear cell infiltrates is observed often. Mononuclear cells in the Virchow–Robin spaces occasionally contain JCV specific DNA and capsid antigen, and in the subcortical white matter adjacent to blood vessels the density of infected cells appears to be increased. In addition, beneath the ependymal layer JCV-infected cells were detected, indicating a close topographical association between infected cells and the ventricular system. These findings may be explained by an essentially faster progress of disease or by differences in the immunological control of JCV infection in HIV/PML.

Oncogenicity of the Human Polyomaviruses

The discussion of a possible oncogenicity of the human polyomaviruses in humans had its origin not only in the oncogenic potential of TAG but also in the bizarre pleomorphism of astrocytes within PML lesions. This was described as a hallmark of PML in the initial description of the disease, and later oligodendroglioma and multifocal glioblastoma were reported, corresponding topographi-

cally to the demyelinated lesions in PML (Frisque and White, 1992; Major *et al.*, 1992; Dörries, 1997). Thus oncogenicity of JCV and BKV was examined almost from the beginning in experimental animal systems. Developing tumour types reflected the cell type specificity of the viruses. As a consequence of the JCV infection, and corresponding to the specificity of JCV for glial cells, brain tumours are observed predominantly. The highest yield is found after intracerebral inoculation of newborn Syrian hamsters, whereas peripheral nervous system tumours are prominent after intraocular virus administration. Central nervous system tumours are located in the cerebrum, the cerebellum, the brainstem and the spinal cord. Mesenchymal tumours within cerebral meninges are classified as malignant meningiomas. Ependymomas are the dominant type of intraventricular tumours, and occasionally choroid plexus tumours are observed. The most common neoplasms are medulloblastomas, at a rate of 95% in newborn hamsters. These are followed by malignant astrocytomas, glioblastoma multiforme, neuroectodermal tumours and pineocytomas. Examination of the neuro-oncogenic potential in primates confirmed the occurrence of malignant glial brain tumours in about 50% of adult monkeys after intracranial JCV infection, the predominant type being characterized as astrocytoma grade 4. JCV T antigen expression in tumour cells suggests that the early region of JCV DNA was present in most tumours. Rescue of JCV from tumour tissue was successful occasionally. Regularly, the virus genome was integrated in tandem copies at single or multiple sites, comparable to the pattern seen in hamster tumours.

The majority of JCV-induced CNS tumour types in hamsters have their human counterpart in tumours of infants, older children or young adults. In view of the giant glial cells being key features in PML, the tendency to form malignant astrocytomas and giant cells appears to be more a characteristic of JCV than that of the animal species inoculated. Although the course of PML does not allow extensive tumour growth, it can therefore be hypothesized that a semipermissive persistent JCV infection might provide the cellular background for transformation and tumour induction in the human host.

The oncogenic potential of BKV appears to be less pronounced, inducing tumours in rodents but not in non-human primates. The most prominent

cell types affected by BKV infection in humans—epithelial cells, fibrocytes, ependymal cells, astrocytes and endothelial cells—are reflected by different tumour types induced in experimental animal models. The type depends essentially on the route of infection, on the amount of virus inoculated and on the BKV isolate used. In addition, as cofactors the age and immunocompetence of the host influence the rate of malignancy.

After intraperitoneal inoculation, tumours are observed rarely; subcutaneous infection yielded sarcomas with an incidence between 2% and 12%. Intravenous inoculation results in ependymomas that can be associated with peripheral tumours, insulinomas, osteosarcomas and tumours of the intestine. In contrast, intracerebral inoculation resulted in choroid plexus papillomas and papillary ependymomas, without a sign of peripheral tumours in 88% of the animals. The disseminated localization of tumours demonstrates a marked tissue tropism and multioncogenicity of BKV in hamsters. Genetic analyses of virus stock preparation with high transforming capacities and predilection for specific tumour types revealed genetic differences. The tumour-inducing activity could be mapped to the BKV transcriptional promoter elements, suggesting that the transforming capacity might depend on the TCR specificity. This also explains the discrepancies of the transforming capacity among various BKV stocks used in tumour induction experiments.

In the tumours, BKV DNA is found either integrated tandemly in the cellular genome or in a free episomal state. In most tumours, complex integration patterns of multiclonal origin were observed. Most cells express nuclear T antigen, virus can often be rescued by cell fusion with permissive cells, and tumour-derived cell lines grow permanently, maintaining their tumour-inducing potential. Selection of a defined integration pattern during prolonged tumour cell culture and decrease in the amount of BKV DNA may point to rearrangements of integrated BKV DNA in the course of tumour growth. This could give rise to cells with simpler integration patterns, and even to the loss of viral DNA. The observation of tumours without intact early gene DNA sequences suggests that an intact T antigen gene is not necessarily needed for maintenance of cell growth, once the transformed state is established.

The spectrum of BKV-induced tumour types is comparable in all susceptible animal species. Thus

specificity of viral expression might be one of the major selection criteria for polyomavirus-associated transforming activity in animal systems. In view of this assumption, it is considered that human polyomaviruses might also be responsible for the respective tumour types in their natural host.

Consequently, the role of JCV and BKV in the aetiology of human tumours was evaluated by many laboratories using most virological and molecular methods available. However, despite the oncogenicity of these viruses in animal systems, an association with human tumours remains controversial (Major *et al.*, 1992; Dörries, 1997; Gallia *et al.*, 1998).

T antigen expression was analysed immunohistologically in medulloblastomas, ependymomas, choroid plexus tumours and urinary tract tumours. The results were inconsistent. Antibody titres to TAg in sera from tumour-bearing patients exhibited no significant difference to sera of healthy people. From these findings the conclusion can be drawn that TAg is not expressed regularly in human tumours. Since TAg must not necessarily be expressed at all stages of tumour growth, the presence of polyomavirus-related DNA sequences was analysed repeatedly in a large number of tumours. So far, JCV DNA sequences were detected only in an oligoastrocytoma, in which neoplastic oligodendroglial cells expressed TAg and in a pleomorphic xanthoastrocytoma in which JCV DNA was isolated by PCR.

Similarly, in a series of human tumours representing tissue from cancers observed with high frequency in animal models and major categories of human cancer, even sensitive DNA hybridization methods did not demonstrate the presence of BKV DNA. Although BKV DNA was occasionally described in CNS tumours, osteosarcomas, tumours of the pancreatic islet, urinary tract carcinomas and Kaposi's sarcoma (De Mattei *et al.*, 1995; Monini *et al.*, 1995, 1996), the detection rate in persistently infected control tissue increased similarly after PCR analysis. This clearly shows that BKV cannot be one of the major causes of human cancer.

Analyses of the state of BKV DNA in malignant tissue revealed tumours carrying mostly episomal virus DNA. Virus mRNA or T antigen expression could be detected; even virus was rescued. This was indicative rather of a persistent state of infection than an association with transforming activities. In contrast, in brain tumours and urogenital tract tu-

mours, integrated BKV-hybridizing DNA sequences are described, thus pointing to a different virus–host interaction being involved. Since virus DNA is present regularly in the human individual, it remains difficult to differentiate between a persistent virus DNA and DNA associated with neoplasia. Whereas in virus persistence intact virus genomes are exclusively in the episomal state, in transformed cells intact as well as defective DNA can either be integrated or in the episomal state. At present, persistent and transforming episomal DNA molecules cannot be differentiated, therefore it is not known whether transformation is associated with both or either state of the DNA.

However, integrated human polyomavirus DNA, as yet only observed in immortalized cells or tumour tissue, might evidence the accidental association of the virus with neoplastic cell changes. In addition, it cannot be ruled out that polyomaviruses interact synergistically with other factors to induce malignant growth in human cells, in which case the presence of BKV DNA in tumour tissue could be a consequence of an event occurring much earlier in the natural history of the tumour when cell growth might be enhanced by T antigen. The virus genome might be lost in an advanced phase, when genetic alterations may activate cellular pathways responsible for cell proliferation. This may not only explain low amounts of viral DNA sequences but also a defective state of viral DNA and argues for an involvement of polyomaviruses during early stages of human tumour development.

DIAGNOSTIC EVALUATION OF POLYOMAVIRUS-ASSOCIATED DISEASE

Diagnosis of PML by Biopsy

The most important disease linked to the human polyomaviruses is PML, with a steadily increasing rate of PML cases in the Western world in the course of the AIDS epidemic. The classical method of PML diagnosis involves neurological evaluation and neuroimaging of the brain followed by definitive laboratory examination of biopsy material (Dörries, 1996; Dörries *et al.*, 1998). Open surgery for PML diagnosis is replaced almost completely by stereotactic biopsy. Topographical selection of

samples at the outer rim of active virus growth provides the best material for virus detection. Diagnosis is based on the identification of virus products and typical cellular changes in glial cells. The extraordinary multiplication rate of the virus in diseased tissue allows detection of viral nucleic acids and proteins by classical methods. Additionally, molecular detection of JCV by PCR is usually confirmed by histopathology.

It is accepted widely that polyomaviruses persist asymptotically in the CNS of adults with former virus contact (Major *et al.*, 1992; Dörries, 1997; Weber and Major, 1997). In the persistent state, virus DNA is not detectable regularly by diagnostic PCR examination of single brain samples. In the activated asymptomatic state of infection the virus load might increase and can then be detected in immunodeficient individuals; however, compared to the thousands of genome equivalents present in PML tissue, the amount of virus is considerably lower. Consequently, in cases with doubtful results quantitative PCR analysis can differentiate a persistently activated and a PML-associated JCV infection. At present, a combination of stereotactic biopsy and PCR techniques ensures a rapid diagnosis of PML with the highest sensitivity and specificity available.

Demonstration of Polyomavirus DNA in CSF

In view of the high frequency of AIDS patients at risk and the future development of therapeutic regimens, the introduction of less invasive methods with a comparable detection rate in early diagnosis of PML is required urgently (Major *et al.*, 1992; Dörries, 1996; Ferrante *et al.*, 1997; Weber and Major, 1997; Dörries *et al.*, 1998). In affected tissue, JCV is present in large amounts, followed by shedding of virus into the CSF. Since concentration of virus in the CSF is considerably lower than that in tissue, PCR is the only technique available at present for virus detection. At first, PCR on CSF was believed to be the most useful tool for PML diagnosis. Undoubtedly it is the most sensitive method; however, it often produces conflicting diagnostic results. Reports on the test specificity vary between about 10% and 80%. Since polyomavirus PCR is not yet standardized, variable specificity rates are in

part caused by technical differences. With increasing numbers of reports, factors such as primer quality, sensitivity of the detection system, extraction methods and sample volume are eliminated. Even the sensitivity of the test systems was enhanced by a second nested PCR amplification of the primary products with internal primer pairs providing detection limits in the range of about 10 genomes. However, nested PCR on the CSF of the high-risk HIV patient without PML revealed similarly JCV amplification. Thus, increase of the detection limits by nested PCR may lead to an increasing number of false-positive PML diagnoses and reduces the prognostic significance of the technique. This finding is explained by asymptomatic activation of JCV CNS infection in states of immunodeficiency. Whether this is indicative for an early state of disease or might represent a timely restricted activation is not yet known.

In addition, even in nested PCR reactions, varying rates of CSF samples remained negative in autopsy-verified PML cases. Serial sampling revealed that the virus load may increase at late stages of disease. In these cases repeated CSF sampling and the time intervals in respect to the progression of disease appear to be essential factors for virus detection. Nevertheless, there are cases remaining negative even at late stages of disease. Concentration of virus, destruction of tissue, therapy and disease history were comparable to those of patients shedding JCV into the CSF. At present, an explanation for the absence of JCV in these cases cannot be given.

From the present position of PCR diagnosis in PML it is clear that PCR is the most sensitive method for the detection of virus in body fluids. However, in view of asymptomatic activation of JCV persistent infection in immunosuppression, differential diagnosis of PML and subclinical infection by PCR testing alone can not be recommended at present for routine diagnosis. Further data on the amount of JCV shedded into the CSF in the course of PML in comparison to JCV infection in the CNS of non-PML patients have to be accumulated. In cases where a correlation is lacking, none of the presently available parameters can be used as a stand-alone criterium for diagnosis of PML; additional determination of clinically relevant data is then needed to confirm the diagnosis of PML. Thus, to date, PCR can only be regarded as a supporting diagnostic tool.

JCV and BKV Specific Antibodies in Serum and CSF

Attempts to establish additional diagnostic procedures focus on the virus specific humoral immune response. Reports emphasize the determination of virus specific antibodies and their dynamic titre changes in the acute disease. The predominant polyomavirus subgroup specific antigenic sites on the major capsid protein VP1 are accessible only after disruption of virions, in virus-infected cells or on purified VP1 protein. Consequently, virus specific antisera produced against intact virus particles are species specific. Species-specific antibodies can be distinguished from one another by neutralization and haemagglutination inhibition (HAI) tests, with a good correlation of virus specific HAI and neutralizing antibody titres (Pass and Shah, 1982).

Prevalence of BKV specific antibodies in sera is about 50% by the age of 3 years and nearly all individuals seroconvert by the age of 10 years (Dörries, 1996). The incidence of JCV antibodies is about 50% during adolescence and more than 80% by adulthood. The rates differ slightly according to demographic data and geographical distribution. Further discrepancies can probably be explained by differential sensitivity of the detection techniques.

The range of polyomavirus specific HAI antibody titres is not dependent on age or sex, but in pregnant women rising titres indicate an incidence of active infection of more than 25%. Since virus specific antibodies in healthy persons and age-matched patients with various tumours and lymphomas exhibited similar geometric mean titres, this is believed to be the result of activation processes mediated by pregnancy in the majority. Titres in patients with malignancies remain stable even under multidrug therapy or immunotherapy, thus demonstrating that JCV antibody titres in sera are not influenced markedly by these diseases or associated therapies. Equally, in PML, the range of JCV specific serum and HAI titres cannot be distinguished from those in the general population. This is explained by the severe basic illnesses abrogating a normal antibody increase, but it cannot be excluded that the low sensitivity of the HAI test may not pick up modest titre changes. The use of the enzyme immunoassay (EIA) for the detection of polyomavirus specific antibodies reveals a better sensitivity with geometric mean titres 10 times high-

er than that of HAI; however, the quality of the results is identical to that of the preceding studies.

The first polyomavirus specific IgM assays were undertaken with BKV antigen. Cross-reactivity of BKV with JCV IgM was not evaluated, and it is an open question as to whether virus specific IgM can be distinguished in double infections. However, prevalence of BKV specific IgM in children was consistent with age distribution of primary BKV infection. Occurrence of BKV IgM in the range of 5% in sera from healthy blood donors is consistent with the finding that BKV activation is uncommon in healthy adults. Thus possible cross-reactive IgM antibodies may be insignificant. JCV specific IgM antibodies were detected in 15% of healthy blood donors. In the same group, almost all sera contained HAI antibodies, suggesting that blood donors harbour the virus in a persistent state. The high prevalence of JCV infections in adults led to the assumption that the presence of IgM is associated frequently with JCV activation in the healthy. In about half of the PML patients a rise of IgM antibodies with increasing levels was observed during progression of the neurological illness. At present, the high prevalence of IgM-positive sera in healthy persons does not allow a correlation of the presence of IgM and acute disease (Knowles *et al.*, 1995).

Polyomavirus Specific Antibodies in CSF

The CSF is usually unremarkable in PML, and JCV HAI titres were detected only rarely. Thus the humoral immune response has been regarded essentially as unhelpful for diagnosis in the past and studies on JCV antibodies and their dynamic changes in the CSF of PML patients are limited to single cases. However, recently synthesized intrathecal JCV specific HAI antibodies and oligoclonal bands were detected in CSF of 67% of confirmed PML cases. Additionally, changes of HAI titre in the CSF were observed under PML treatment, suggesting that JCV specific antibodies might additionally be responsive to therapeutic intervention. Thus JCV HAI antibodies produced intrathecally appear to suggest active JCV multiplication within the CNS. The range of titres in individual PML patients appears to be highly dependent on the state of the disease and may also reflect

the type of underlying disease, with characteristics affecting different parameters of the immune system. Analyses of virus specific, intrathecally produced antibodies and oligoclonal bands are well matched in PML versus non-immunosuppressed cases.

Although studies are limited, it can be assumed that a mild intrathecal immune response with the presence of oligoclonal JCV specific antibodies indicates intra-CNS growth of JCV. It remains to be determined whether the finding of intrathecally produced JCV specific antibodies and oligoclonal bands indicates acute disease and PML only, or might also be characteristic of a persistent activated state under immune impairment (Sindic *et al.*, 1997). There is no doubt that enhancement of system sensitivity and follow-up studies of the high-risk patient groups is needed for further diagnostic evaluation of those parameters. In addition, a thorough examination of the humoral immune response to JCV in PML patients (Frye *et al.*, 1997), to define specificity and frequency of intrathecal antibodies and oligoclonal bands, must be undertaken prior to a decision on the usefulness of these assays as a diagnostic tool for PML.

TREATMENT OF HUMAN POLYOMAVIRUS INFECTIONS

Treatment of human polyomavirus infections concentrates on PML. A number of different treatment regimens has been proposed on the basis of molecular findings and small series of patients. However, randomized therapeutic trials are mostly lacking and the observation that PML may remain stable for long periods of time, or even remit, highlights the inadequacies of anecdotal reports suggesting the value of a specific therapy (Major *et al.*, 1992; Berger and Concha, 1995; Weber and Major, 1997).

Nucleoside analogues have proven to interfere with viral DNA synthesis in virus infections, and several compounds have been used for the treatment of PML. Cytosine arabinoside (ARA-C, cytarabine) has been used from the early beginnings: various degrees of improvement have been reported. Recently acquired molecular data showed that cytosine-b-d-arabinofuranoside suppressed JCV replication in tissue culture, thus supporting the potential interference of ARA-C with PML.

However, first reports on the efficacy of ARA-C therapy by the AIDS Clinical Trials Group in the treatment of PML showed no benefit of ARA-C. Other analogues, such as adenosine arabinoside (ARA-A, vidarabine), iododeoxyuridine or zidovudine, similarly do not appear to have an effect on PML.

Recently, it was found that the newly approved cidofovir diphosphate, a structural analogue of deoxycytidine triphosphate, is not only a potent inhibitor of human herpes and papillomaviruses, but is also a selective antipolyomavirus agent. A first report on clinical improvement of a PML patient in association with cidofovir/ARA-C therapy points to a potential role of this drug in AIDS-related PML treatment. Camptothecin, a DNA topoisomerase inhibitor shown to block JCV replication *in vitro*, led to clinical improvement in a patient with systemic lupus erythematosus, but immunosuppressive therapy was suspended concomitantly. Antiretroviral therapy has been reported anecdotally to result in improvement of PML; however, improvement of cellular immunity might be the major cause for prolonged survival times in these cases. Similarly, introduction of protease inhibitors and triple drug therapies for AIDS did not influence the outcome of PML.

The use of immune modulatory agents for PML therapy is based on the findings of extended survival in patients with improvement of immunological competence. Interferon α has an established efficacy for the treatment of other popovavirus associated diseases and prolonged survival was reported. In contradiction to these results, other studies reported no significant enhancement in survival time. Similar discrepancies were found with the combination of adenine arabinoside and interferon β or transfer factor revealing no efficacy, whereas interferon alone was associated with modest improvement in the clinical picture and magnetic resonance imaging. Recently, an effect on survival was described after interleukin 2 treatment of a lymphoma patient after bone marrow transplantation. In this case it is not clear whether the treatment or rather the stabilization of immunocompetence was responsible for the remission of PML. In addition, treatment with low-dose heparin sulphate was suggested to prevent seeding of JCV to the CNS by activated lymphocytes. Since JCV persists in the CNS for life after primary contact with the virus, a beneficial effect appears to be rather

unlikely. Other agents have been tried, either alone or in combination. No effect has been found with corticosteroid therapy or tilorone, an immune enhancer. The use of antisense oligonucleotides to prevent virus specific protein expression has been proposed but awaits development of appropriate drugs. Thus unequivocal effective therapy of PML as yet remains elusive.

With 5–20% of AIDS patients succumbing eventually to AIDS-associated PML, the disease is the third most common process producing focal CNS lesions in these patients. In contrast to other opportunistic CNS disorders, the outcome remains fatal in almost all cases. Thus further investigation and collaborative efforts are needed to decide which of the different approaches might be effective for the treatment of PML.

ACKNOWLEDGEMENTS

Work in the author's laboratory was supported by SFB 165/B3 of the Deutsche Forschungsgesellschaft and by Grant 91.061 of the Wilhelm Sander-Stiftung.

REFERENCES

- Agostini, H.T., Ryschkewitsch, C.F., Mory, R. *et al.* (1997a) JC virus (JCV) genotypes in brain tissue from patients with progressive multifocal leukoencephalopathy (PML) and in urine from controls without PML: increased frequency of JCV type 2 in PML. *Journal of Infectious Diseases*, **176**, 1–8.
- Agostini, H.T., Ryschkewitsch, C.F., Singer, E.J. *et al.* (1997b) JC virus regulatory region rearrangements and genotypes in progressive multifocal leukoencephalopathy: two independent aspects of virus variation. *Journal of General Virology*, **78**, 659–664.
- Arthur, R.R. and Shah, K.V. (1989) Occurrence and significance of papovaviruses BK and JC in the urine. *Progress in Medical Virology*, **36**, 42–61.
- Atwood, W.J., Wang, L., Durham, L.C. *et al.* (1995) Evaluation of the role of cytokine activation in the multiplication of JC virus (JCV) in human fetal glial cells. *Journal of Neurovirology*, **1**, 40–49.
- Ault, G.S. (1997) Activity of JC virus archetype and PML-type regulatory regions in glial cells. *Journal of General Virology*, **78**, 163–169.
- Berger, J.R. and Concha, M. (1995) Progressive multifocal leukoencephalopathy: the evolution of a disease once considered rare. *Journal of Neurovirology*, **1**, 5–18.
- Brooks, B.R. and Walker, D.L. (1984) Progressive multifocal leukoencephalopathy. *Neurological Clinics*, **2**, 299–313.
- Chang, D., Fung, C.Y., Ou, W.C. *et al.* (1997) Self-assembly of the

- JC virus major capsid protein, VP1, expressed in insect cells. *Journal of General Virology*, **78**, 1435–1439.
- Chen, N.N., Kerr, D., Chang, C.F. *et al.* (1997) Evidence for regulation of transcription and replication of the human neurotropic virus JCV genome by the human S(mu)bp-2 protein in glial cells. *Gene*, **185**, 55–62.
- Daniel, A.M., Swenson, J.J., Mayreddy, R.P.R. *et al.* (1996) Sequences within the early and late promoters of archetype JC virus restrict viral DNA replication and infectivity. *Virology*, **216**, 90–101.
- De Mattei, M., Martini, F., Corallini, A. *et al.* (1995) High incidence of BK virus large-T-antigen-coding sequences in normal human tissues and tumors of different histotypes. *International Journal of Cancer*, **61**, 756–760.
- Dörries, K. (1996) Virus–host interactions and the diagnosis of human polyomavirus associated disease. *Intervirology*, **39**, 165–175.
- Dörries, K. (1997) New aspects in the pathogenesis of polyomavirus-induced disease. *Advances In Virus Research*, **48**, 205–261.
- Dörries, K. (1998) Molecular biology and pathogenesis of human polyomavirus infections. *Developments in Biological Standardization Basel*, **94**, 67–75.
- Dörries, K., Arendt, G., Eggers, C. *et al.* (1998) Nucleic acid detection as a diagnostic tool in polyomavirus JC induced progressive multifocal leukoencephalopathy. *Journal of Medical Virology*, **54**, 196–203.
- Elsner, C. and Dörries, K. (1998) Human polyomavirus JC control region variants in persistently infected CNS and kidney tissue. *Journal of General Virology*, **79**, 789–799.
- Ferrante, P., Caldarelli Stefano, R., Omodeo Zorini, E. *et al.* (1997) Comprehensive investigation of the presence of JC virus in AIDS patients with and without progressive multifocal leukoencephalopathy. *Journal of Medical Virology*, **52**, 235–242.
- Frisque, R.J. and White, F.A. (1992) The molecular biology of JC virus, causative agent of progressive multifocal leukoencephalopathy. In *Molecular Neurovirology* (ed. R.P. Roos), pp 25–158. Humana Press, Totowa NJ.
- Frisque, R.J., Bream, G.L. and Cannella, M.T. (1984) Human polyomavirus JC virus genome. *Journal of Virology*, **51**, 458–460.
- Frye, S., Trebst, C., Dittmer, U. *et al.* (1997) Efficient production of JC virus in SVG cells and the use of purified viral antigens for analysis of specific humoral and cellular immune response. *Journal of Virological Methods*, **63**, 81–92.
- Gallia, G.L., Houff, S.A., Major, E.O. *et al.* (1997) Review: JC virus infection of lymphocytes—revisited. *Journal of Infectious Diseases*, **176**, 1603–1609.
- Gallia, G.L., Gordon, T. and Khalili, K. (1998) Tumor pathogenesis of human neurotropic JC virus in the CNS. *Journal of Neurovirology*, **4**, 175–181.
- Heilbronn, R., Albrecht, I., Stephan, S. *et al.* (1993) Human cytomegalovirus induces JC virus DNA replication in human fibroblasts. *Proceedings of the National Academy of Sciences of the USA*, **90**, 11406–11410.
- Hogan, T.H., Padgett, B.L. and Walker, D.L. (1984) Human polyomaviruses. In *Textbook in Human Virology* (ed. R.B. Belshe), pp 969–995. PSG Publishing, Littleton MA.
- Jin, L., Gibson, P.E., Knowles, W.A. *et al.* (1993) BK virus antigenic variants: sequence analysis within the capsid VP1 epitope. *Journal of Medical Virology*, **39**, 50–56.
- Kitamura, T., Kunitake, T., Guo, J. *et al.* (1994a) Transmission of the human polyomavirus JC virus occurs both within the family and outside the family. *Journal of Clinical Microbiology*, **32**, 2359–2363.
- Kitamura, T., Satoh, K., Tominaga, T. *et al.* (1994b) Alteration in the JC polyomavirus genome is enhanced in immunosuppressed renal transplant patients. *Virology*, **198**, 341–345.
- Knowles, W.A., Luxton, R.W., Hand, J.F. *et al.* (1995) The JC virus antibody response in serum and cerebrospinal fluid in progressive multifocal leukoencephalopathy. *Clinical and Diagnostic Virology*, **4**, 183–194.
- Kumar, K.U., Devireddy, L.R., Tang, S.C. *et al.* (1996a) Human JC virus nuclear factor 1 binding motifs and large tumor antigen region required for transactivation of late promoter. *Journal of Neurochemistry*, **67**, 473–481.
- Kumar, K.U., Reddy, D.L., Pater, M.M. *et al.* (1996b) Human JC virus cAMP response elements functional for enhanced glial cell expression in differentiating embryonal carcinoma cells. *Virology*, **215**, 178–185.
- Kumar, K.U., Tang, S.C., Pater, M.M. *et al.* (1996c) Glial and muscle embryonal carcinoma cell-specific independent regulation of expression of human JC virus early promoter by cyclic AMP response elements and adjacent nuclear factor 1 binding sites. *Journal of Medical Virology*, **49**, 199–204.
- Loeber, G. and Dörries, K. (1988) DNA rearrangements in organ-specific variants of polyomavirus JC strain GS. *Journal of Virology*, **62**, 1730–1735.
- Major, E.O., Amemiya, K., Tornatore, C.S. *et al.* (1992) Pathogenesis and molecular biology of progressive multifocal leukoencephalopathy, the JC virus-induced demyelinating disease of the human brain. *Clinical Microbiology Reviews*, **5**, 49–73.
- Mayreddy, R.P., Safak, M., Razmara, M. *et al.* (1996) Transcription of the JC virus archetype late genome: importance of the kappa B and the 23-base-pair motifs in late promoter activity in glial cells. *Journal of Virology*, **70**, 2387–2393.
- Monini, P., de Lellis, L., Rotola, A. *et al.* (1995) Chimeric BK virus DNA episomes in a papillary urothelial bladder carcinoma. *Intervirology*, **38**, 304–308.
- Monini, P., Rotola, A., de Lellis, L. *et al.* (1996) Latent BK virus infection and Kaposi's sarcoma pathogenesis. *International Journal of Cancer*, **66**, 717–722.
- Negrini, M., Sabbioni, S., Arthur, R.R. *et al.* (1991) Prevalence of the archetypal regulatory region and sequence polymorphisms in nonpassaged BK virus variants. *Journal of Virology*, **65**, 5092–5095.
- Padgett, B.L. and Walker, D.L. (1976) New human papovaviruses. *Progress in Medical Virology*, **22**, 1–35.
- Pass, F. and Shah, K.V. (1982) Immunology of human papovaviruses. In *Immunology of Human Infection. Part II Viruses and Parasites; Immunodiagnosis and Prevention of Infectious Disease* (eds A.J. Nahmias and R.J. O'Reilly), pp 225–241. Plenum Medical, New York.
- Raj, G.V. and Khalili, K. (1995) Transcriptional regulation: lessons from the human neurotropic polyomavirus, JCV. *Virology*, **213**, 283–291.
- Raj, G.V., Safak, M., MacDonald, G.H. *et al.* (1996) Transcriptional regulation of human polyomavirus JC: evidence for a functional interaction between Re1A (p65) and the Y-box-binding protein, YB-1. *Journal of Virology*, **70**, 5944–5953.

- Remenick, J., Radonovich, M.F. and Brady, J.N. (1991) Human immunodeficiency virus Tat transactivation: induction of a tissue-specific enhancer in a nonpermissive cell line. *Journal of Virology*, **65**, 5641–5646.
- Shinohara, T., Matsuda, M., Cheng, S.H. *et al.* (1993) BK virus infection of the human urinary tract. *Journal of Medical Virology*, **41**, 301–305.
- Sindic, C.J., Trebst, C., Van Antwerpen, M.P. *et al.* (1997) Detection of CSF-specific oligoclonal antibodies to recombinant JC virus VP1 in patients with progressive multifocal leukoencephalopathy. *Journal of Neuroimmunology*, **76**, 100–104.
- Sugimoto, C., Kitamura, T., Guo, J. *et al.* (1997) Typing of urinary JC virus DNA offers a novel means of tracing human migrations. *Proceedings of the National Academy of Sciences of the USA*, **94**, 9191–9196.
- Sumner, C., Shinohara, T., Durham, L. *et al.* (1996) Expression of multiple classes of the nuclear factor-1 family in the developing human brain: differential expression of two classes of NF-1 genes. *Journal of Neurovirology*, **2**, 87–100.
- Trowbridge, P.W. and Frisque, R.J. (1995) Identification of three new JC virus proteins generated by alternative splicing of the early viral mRNA. *Journal of Neurovirology*, **1**, 195–206.
- Vallbracht, A., Löhler, J., Gossmann, J. *et al.* (1993) Disseminated BK type polyomavirus infection in an AIDS patient associated with central nervous system disease. *American Journal of Pathology*, **143**, 29–39.
- Walker, D.L. and Padgett, B.L. (1983) Progressive multifocal leukoencephalopathy. *Comprehensive Virology*, **18**, 161–193.
- Weber, T. and Major, E.O. (1997) Progressive multifocal leukoencephalopathy: molecular biology, pathogenesis and clinical impact. *Intervirology*, **40**, 98–111.
- Zu Rhein, G.M. (1969) Association of papova-virions with a human demyelinating disease (progressive multifocal leukoencephalopathy). *Progress in Medical Virology*, **11**, 185–247.

Human Parvoviruses

John R. Pattison

Royal Free and University College Medical School, London, UK

INTRODUCTION

The family *Parvoviridae* consists of two subfamilies, the *Parvovirinae* and the *Densovirinae* and each of these subfamilies contains three genera (Table 24.1). To date there is only one known human pathogen (parvovirus B19) in this entire family of viruses. The *Densovirinae* are all viruses of insects. The genus *Parvovirus* contains a wide range of viruses of mammals and birds, some of which cause major diseases in their animal hosts, but some, isolated as contaminants of cell cultures, have unknown primary hosts. The dependoviruses have been described in a number of mammalian species and serology shows that adeno-associated viruses 1–4 are common human infections. These viruses are dependent for their replication upon coinfection with a helper virus, such as adenovirus or herpes simplex virus, and have not as yet been linked with disease in either humans or animals.

Human parvovirus B19 was initially discovered in the serum of asymptomatic blood donors as a cause of false-positive results in counterimmunoelectrophoresis (CIE) tests for the detection of hepatitis B virus surface antigen (Cossart *et al.*, 1975). In 1983 the precise chemical nature of the agent was described (Summers *et al.*, 1983) and the virus was initially classified with the autonomous parvoviruses. However, more recently B19 parvovirus was reclassified as the first, and currently only, member and type species of the genus *Erythrovirus*. Subsequently three simian parvoviruses have been identified in cynomolgus monkeys, pig-tailed

macaques and rhesus macaques (Brown and Young, 1997). These erythroviruses share with B19 up to 60% homology, similar genome organization and similar biological behaviour in natural hosts. Interestingly, among the *Parvovirinae* in general, the sequence homology suggests that B19 parvovirus (genus *Erythrovirus*), minute virus of mice (genus *Parvovirus*) and adeno-associated virus (genus *Dependovirus*) are equally different from each other, suggesting that they diverged at about the same evolutionary point in time.

Paaver and colleagues (1973) were the first to describe human parvovirus-like particles in stool specimens. Such particles have subsequently been found in outbreaks of gastroenteritis associated with the consumption of shellfish in whose tissues they may also be detectable. These particles have not yet been fully characterized and so their classification must await definitive molecular studies. Moreover similar particles may on occasion be found in the faeces of asymptomatic individuals, so the precise pathogenic role of these agents remains unclear (see Chapter 4).

Most recently workers in Japan have found evidence of single-stranded DNA viruses in the serum of patients with hepatitis of unknown aetiology following liver transplantation (Nishizawa *et al.*, 1997). Subsequently studies have shown that infection with this virus, which has been called TTV, is common (Okamoto *et al.*, 1998). The virus is discussed further in Chapter 3.

Table 24.1 The *Parvoviridae*

Subfamily	Genera	Hosts
<i>Parvovirinae</i>	<i>Parvovirus</i>	Animals (cats, dogs, rodents, pigs, birds, etc.)
	<i>Erythrovirus</i>	Humans (and probably monkeys)
	<i>Dependovirus</i>	Animals (man, birds, dogs, cattle, horses, sheep)
<i>Densovirinae</i>	<i>Densovirus</i>	Insects
	<i>Iteravirus</i>	
	<i>Brevidensovirus</i>	

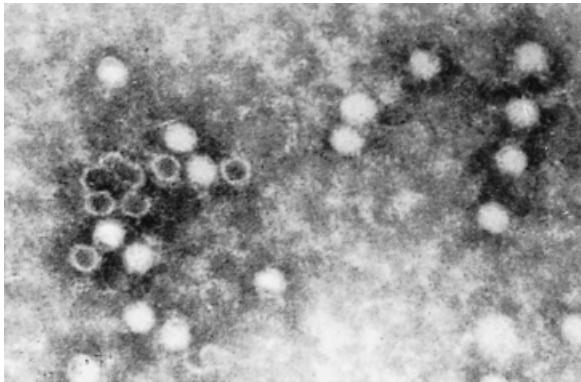

Figure 24.1 The appearance of *B19 virus* in the serum of a case of aplastic crisis in a child with sickle cell anaemia. (Reproduced with permission from *Parvoviruses: medical and biological aspects*, Pattison, J.R. in *Fields Virology*, 2nd edition 1990, p 1767)

B19 VIRUS

Structure

In electron micrographs of negatively stained preparations parvoviruses appear as naked, spherical particles with a diameter varying from 20 to 25 nm, with a mean of 23 nm. The individual virus particles are icosahedral in form and disrupted fragments and empty shells are a characteristic feature. The appearance of *B19 virus* conforms to this description (Figure 24.1).

Parvovirus particles band at a density of 1.31–1.43 g ml⁻¹ in CsCl gradients. The buoyant density of *B19 virus* is at the top end of the range at 1.43, whereas the empty particles have a density of 1.31 g ml⁻¹. As with all parvovirus particles the infectious particle is stable over a wide range of pH and resistant to lipid solvents. It is not quite so

resistant to heat as other parvoviruses but still survives 48°C for 30 minutes (Young *et al.*, 1984).

Genome Organization

Approximately 20–30% of parvovirus virions consists of a linear single strand of DNA with a molecular weight of approximately 1.8×10^6 . In general, autonomous parvoviruses preferentially encapsidate single-stranded DNA of negative polarity but *B19 virus* encapsidates positive and negative strands with equal frequency. The genome of *B19 virus* is one of the largest among the parvoviruses, with 5500 nucleotides. All parvovirus genomes have palindromic sequences at both the 5' and 3' termini. These segments of the DNA fold back on themselves to form hairpin loops which are stabilized by hydrogen bonding. The hairpin termini of *B19 virus* are substantially longer than those of most parvoviruses and the palindromic sequences appear to be more than 365 nucleotides in length. There is some mismatching in the middle of the hairpin leading to the occurrence of two different sequence configurations referred to as flip and flop, which is typical of parvovirus genomes (Deiss *et al.*, 1990).

There are several possible promoter sites in the *B19* genome but only that at map point 6 appears to be functional, with all transcripts being initiated at this point. As is usual with parvoviruses the 5' end of the genome codes for the non-structural protein and the 3' end of the genome for the capsid proteins. There are nine RNA transcripts in infected erythroid cells but only three associated with the known viral proteins described below (Ozawa *et al.*, 1987a; Luo and Astell, 1993).

Viral Proteins

There is one non-structural protein, NS1, produced by transcription of the *B19 virus* genome. The non-structural proteins of parvoviruses have been shown to have many functions (Young, 1996) and the NS1 of *B19 virus* is notable for its toxicity to cells (Ozawa *et al.*, 1988). There are two structural proteins in *B19 virus*—VP1 (84 kDa) and VP2 (58 kDa)—which differ only in that VP1 has an additional 227 amino acids at the amino terminus (Shade *et al.*, 1986). The capsid of *B19* is composed

of approximately 5–10% VP1 and the remainder is VP2. The structure of canine parvovirus (CAV) has been determined in detail (Tsao *et al.*, 1991) and structural studies have been undertaken for B19. They indicate that the central structural core of eight antiparallel β -sheets is present in B19 but the prominent spikes on the threefold axis of CPV are absent from B19 (Agbandje *et al.*, 1994).

Virus Variation

There appears to be a single, stable antigenic type of *B19 virus*. Infection is followed by lifelong immunity, which indicates a single neutralizable type. Minor variation between different isolates of the virus in their reactivity with mouse monoclonal antibodies has been detected but this has so far not proved to be of epidemiological or diagnostic significance.

Similarly the genome of B19 virus shows a constancy that is typical of viruses with DNA genomes. Restriction endonuclease analysis of many isolates collected over a period of 10–12 years shows lack of variation. Moreover, oligonucleotide sequences from all the linear regions of the genome amplify a variety of isolates of *B19 virus* in polymerase chain reactions. There is one report (Koch and Adler, 1990) of minor genomic variations using this technique but the balance of experience suggests that it is likely that the polymerase chain reaction (PCR) will detect the great majority of, if not all, B19 isolates.

PATHOGENESIS

For a number of years following its discovery *B19 virus* appeared to be associated with, at most, a mild, non-specific, febrile illness accompanied by self-limiting leucopenia. In the early 1980s the central role of *B19 virus* in the aetiology of aplastic crisis in chronic haemolytic anaemias (Sergeant *et al.*, 1981) was identified and then, in 1983, erythema infectiosum (fifth disease) began to emerge as the common manifestation of B19 virus infection (Anderson and Pattison, 1985). Subsequently the virus has been shown to cause chronic infection in the immunocompromised (Kurtzman *et al.*, 1988, 1989) and to be responsible for a significant percentage of cases of hydrops fetalis (Anand *et al.*, 1987). It is

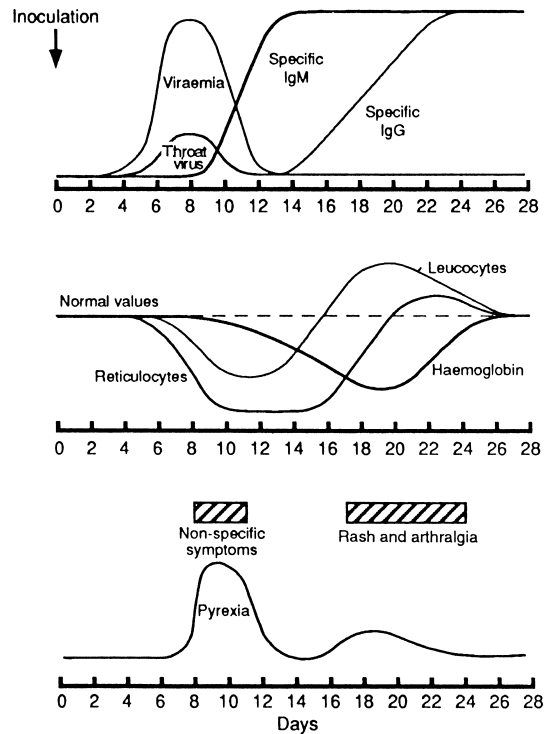

Figure 24.2 Virological, haematological and clinical events during B19 virus infection of volunteers

now clear that the pathogenesis of B19 virus-associated disease involves two separate components. The first is due to the lytic infection of susceptible dividing cells and the second is dependent upon interaction with the immune response.

Volunteer Studies

B19 virus has on occasion been detected in throat swabs, and respiratory tract spread was confirmed when a group of volunteers was successfully infected with *B19 virus* following intranasal inoculation (Anderson *et al.*, 1985a). The sequence of events following intranasal inoculation of susceptible individuals is shown diagrammatically in Figure 24.2. The virus sets up a systemic infection with copious viraemia detectable for about 6 days, 1 week after inoculation. At the same time virus is shed from the respiratory tract. As the titre of virus in blood falls, IgM antibody begins to appear and B19–IgM immune complexes may be detected. Parvovirus-spe-

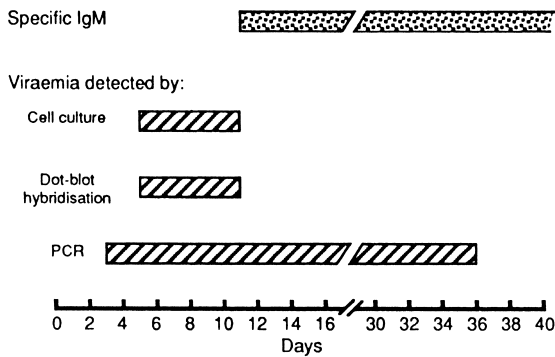

Figure 24.3 The detection of *B19 virus* in the serum of a volunteer infected on day 0

cific IgM is first detectable towards the end of the second week after inoculation, with levels usually rising rapidly to reach a maximum within a few days; thereafter this antibody declines but may be detected for a total of about 2–3 months. There is a delay of some days in the production of IgG anti-B19, which cannot be detected until the third week after inoculation, and amounts increase more slowly than is seen with IgM. Reinfection has been documented in one volunteer: 7 days after intranasal inoculation, a brief low-titre viraemia was detected. The IgG response was accelerated so that IgG and IgM anti-B19 appeared simultaneously.

Recent studies using *in vitro* culture for the detection of infectious *B19 virus* indicate that infectious virus may be detectable as early as 3 days after inoculation. The presence of infectious virus in the stored serum of the volunteers was relatively short lived and the disappearance correlates with the rise in IgM anti-B19. By contrast (Figure 24.3) B19 DNA can be detected for many weeks using a nested PCR (unpublished observations). The likely explanation of this is that immune-complexed virus persists in phagocytic cells, since the addition of mixtures of infectious virus and specific antibody to cell cultures from fetal liver tissue leads to strong DNA hybridization signals within the cytoplasm of phagocytic macrophages (Dr A.L. Morey, personal communication). This intracellular complexed virus will not be significant in the transmission of the infection, nor is it likely to be of clinical significance in a normal individual.

During viraemia reticulocyte numbers fall to undetectable levels, recovering 7–10 days later. There is a consequent temporary fall in haemoglobin of about 1 g dl^{-1} in a normal individual. Lympho-

penia, neutropenia and thrombocytopenia do occur (not shown in Figure 24.2), though slightly later, with the lowest numbers being recorded 6–10 days after inoculation and not so consistently as the changes in reticulocyte numbers and haemoglobin concentration.

The symptoms of erythema infectiosum occur late in the course of events in volunteers, with the rash appearing 17–18 days after inoculation and joint symptoms of arthralgia a day or so later. Virus is not detectable at this time except by the most sensitive PCR assays. Although the exact mechanism of production of these symptoms remains to be elucidated, an immune-mediated pathogenesis seems likely. Studies of infected fetal tissue (Morey *et al.*, 1992) have failed to reveal infection of vascular endothelial cells, whereas circulating immune complexes have been detected in volunteers and at present these seem the most likely cause of the rash and arthralgia.

Cell Tropism

Autonomous parvoviruses are so called because they do not require the presence of a helper virus for replication. However, they do depend on certain helper functions expressed transiently in cells during the late S or early G₂ phase of mitosis. Therefore virus replication will be relatively extensive in rapidly dividing tissues and it is not surprising that diseases of the intestine, the haematopoietic system and the fetus feature frequently as consequences of parvovirus infection in animals. However, it should be remembered that parvoviruses are not pan-tropic, since there is evidence that susceptibility to parvovirus infection is related to a particular stage of differentiation of a cell.

Brown and colleagues (1993) identified the cell receptor for B19 as globoside or erythrocyte P antigen. This antigen is found on mature erythrocytes and erythroid progenitor cells. Purified P antigen (globoside) blocks the binding of virus to erythroid cells and these cells can be protected from infection by preincubation with monoclonal antibody to globoside. Interestingly P antigen can also be found on megakaryocytes, endothelial cells, placenta and on fetal cardiac myocytes and these findings may have some implications for the pathogenesis of B19-related diseases. Propagation *in vitro* has been

achieved in erythroid cells of human bone marrow (Ozawa *et al.*, 1987b), fetal liver (Yaegashi *et al.*, 1989), in cultured cells from a patient with erythro-leukaemia (Takahashi *et al.*, 1989) and in a human megakaryocytoblastoid cell line (UT-7) derived from a patient with leukaemia (Shimomura *et al.*, 1992). An early erythrocyte precursor is susceptible to B19 virus infection. When bone marrow or peripheral blood cells are cultured to develop BFUe colonies (haemoglobin-containing erythrocyte precursor cells) in the presence of B19 virus the formation of colonies is inhibited. The same is true of the later erythroid progenitor cell which goes on to form CFU-E in culture. In all culture systems virus propagation is dependent on the presence of erythropoietin: even the UT-7 cell line will only support virus replication after growth in the presence of erythropoietin for months.

Two cells are characteristic of B19 virus infection of the erythroid lineage. Giant pronormoblasts are characteristically seen in the bone marrow of patients at the height of transient aplastic crisis. These cells, which have been recognized for almost 50 years (Owen, 1948), probably represent the virus cytopathic effect of the non-structural protein and they do not contain complete virus particles. Later erythroid precursors, the normoblasts, do exhibit a characteristic intranuclear eosinophilic inclusion body which displaces the nuclear chromatin to the margin. These inclusions are packed with complete virions (Young, 1996) and stain positively for B19 DNA. Productive infection in these cells is the only known source of the intense viraemia that is characteristic of B19 infections. Megakaryocytopoiesis is also inhibited by B19 parvovirus *in vitro* but this is in the absence of virus replication and almost certainly due to the cytotoxic effect of NS1 (Srivastava *et al.*, 1990).

EPIDEMIOLOGY

Serological studies show that infection with B19 virus is worldwide in distribution, occurring in all populations studied with the exception of some isolated groups in Brazil and Africa (Schwarz *et al.*, 1989; De Freitas *et al.*, 1990). In temperate climates infection occurs throughout the year but outbreaks are more common in late winter, spring and the early summer months. These outbreaks of infection

are often centred on primary schools, where up to 40% of the school may be clinically affected by the rash illness of erythema infectiosum. If one includes subclinical infection then the attack rates may be as high as 60% of the susceptible population in a school (Plummer *et al.*, 1985). During these outbreaks, susceptible adults (parents and teachers of cases) frequently become infected.

Clinical observations of the frequency of cases of erythema infectiosum among different age groups reflect the serological profile of the population; antibodies are most commonly acquired between the ages of 4 and 10 years, after which the frequency continues to rise, but more slowly, so that among the blood donor population (aged 18–65 years) some 60% are seropositive (Cohen *et al.*, 1983). Most of these studies have been done in developed countries. In developing countries the acquisition of antibody occurs at an earlier age and infection appears to be common in the third, fourth and fifth years of life.

In addition to seasonality, the virus exhibits longer-term cycles. For example, in Jamaica, peaks of incidence (monitored as cases of aplastic crisis) occur every 3–4 years. In the UK, the cycle seems somewhat longer, with peaks occurring every 4–5 years.

Case-to-case intervals, determined by the time elapsing between acquisition and excretion of the virus, are independent of the type of disease. Volunteer studies predict case-to-case intervals of 6–11 days, which accords well with case-to-case intervals observed both in outbreaks of erythema infectiosum and in aplastic crisis. Transmission between siblings is common, and in families where more than one child is affected by chronic haemolytic anaemia all susceptibles should be monitored for 2 weeks if one develops an aplastic crisis.

Although spread from respiratory tract to respiratory tract is the common route of transmission of B19 virus, the high-titre viraemia which occurs during infection can lead to another mode of transmission. Virus is found in donated units of blood, although the incidence is low (1 in 20 000–40 000) in epidemic periods, as would be expected of an acute infection circulating mainly among children. In spite of this low incidence, blood-borne transmission has been shown to occur in recipients of whole blood and of factor VIII concentrates (Mortimer *et al.*, 1983). The frequency of seropositivity among haemophiliacs is significantly higher than in

Table 24.2 Relationship between nature of clinical disease and host factors in B19 virus infection

Disease	Host	
Asymptomatic Respiratory tract illness Rash illness Arthralgia	Normal	
Severe anaemia		
		Chronic haemolytic anaemia
		Immunosuppressed Intrauterine infection

Adapted, with permission, from Pattison, J.R. in *Medical Microbiology*, 14th edition, edited by Greenwood, Slack and Peutherer (1992).

normals, except for those haemophiliacs who have received factor VIII concentrates that have been heated to 80°C for 72 hours (Williams *et al.*, 1990). Even so, *B19 virus* can be transmitted by treated blood products (Lyon *et al.*, 1989).

CLINICAL FEATURES

The consequences of B19 virus infection range from the wholly asymptomatic to serious and potentially fatal conditions in a minority of the population that is particularly predisposed. This spectrum of clinical consequences of infection is illustrated in Table 24.2 and depends in part on the natural variation in symptomatology that occurs with common childhood infection and in part on recognizable host factors.

Minor Illness

Combined clinical and laboratory studies of infection in children, in whom B19 infection is most common, have indicated that about half of all infections are asymptomatic. Non-specific respiratory tract illness is the next most common consequence of infection, at least in boys (Grilli *et al.*, 1989). This can be mild or severe enough to mimic influenza and these respiratory tract illnesses coincide with the viraemic phase of the illness.

Rash Illness

The non-specific, short-lived febrile episodes described above also occur as prodromal symptoms

to a rash illness in B19 virus infections. However, individuals are symptom-free for some 7 days between the minor febrile episode and the appearance of the rash, and it is likely that this relatively long period between the biphasic symptoms has prevented the recognition of a link between non-specific prodromal symptoms and a rash illness. Certainly most individual patients will not give a history of any prodrome before the onset of the rash, and the accumulated literature over the past 100 years contains a conspicuous absence of any description of prodromal symptoms of erythema infectiosum.

The link between B19 virus infection and erythema infectiosum was made in 1983 (Anderson *et al.*, 1984), even though in retrospect there was evidence of a link between B19 infection and rash illness from the time of the earliest descriptions of the virus (Cossart *et al.*, 1975). One of the original viraemic individuals had a rubelliform rash 4 days after the viraemia, and the children of another of the original individuals had itchy rashes 3–5 weeks after their mother was viraemic. During the last 10 years the use of specific laboratory tests for the diagnosis of B19 virus infection has revealed a spectrum of rash illness, due to B19 infection, in which the classic features of erythema infectiosum occupy a central position.

Erythema infectiosum is most common in children aged 4–11 years and is sometimes called fifth disease because it was the fifth of six erythematous rashes of childhood in an old classification. The exanthem occurs in three stages. The first begins some 18 days after the acquisition of infection and is characterized by a fiery red rash on the cheeks—slapped-cheek appearance (Figure 24.4, *see* Plate IV). The edges of the involved areas may be slightly raised and there is relative circumoral pallor. At this stage the appearance may be suggestive of scarlet fever, drug sensitivity or other allergic reactions, or collagen vascular diseases. The second stage of the exanthem occurs 1–4 days after the facial involvement with the appearance of an erythematous, maculopapular rash on the trunk and limbs (Figure 24.5, *see* Plate IV). This rash is initially discrete but spreads to involve large areas. Towards the end of this stage there is central clearing of the rash from these areas to give the characteristic lacy or reticular pattern (Figure 24.6, *see* Plate IV). The third stage of the exanthem is highly variable in duration, lasting from 1–3 or more weeks, and is characterized by marked changes in

the intensity of the rash, with periodic complete evanescence and recrudescence. These fluctuations are related to environmental factors such as the exposure to sunlight and temperature (a hot bath may result in recrudescence in an apparently recovered child). The rash is often pruritic, especially in adults, and is generally more prominent on the extensor surfaces; the palms and soles are rarely affected.

While classic cases of erythema infectiosum are easy to recognize clinically, especially during outbreaks, there is a wide variation in the form of the exanthem, from a very faint, fleeting rash to a florid exanthem, confluent over large areas. In many cases the illness is clinically indistinguishable from rubella.

Erythema infectiosum is essentially a benign disease in which the major complication is joint involvement (see below). Other reported complications include cases of transient haemolytic anaemia, encephalitis with recovery without residua, and encephalopathy in a 9-month-old boy resulting in permanent sequelae. Each of these cases occurred prior to the appreciation of *B19 virus* as the causative agent for erythema infectiosum; in view of the difficulty in diagnosing sporadic cases of erythema infectiosum on clinical grounds, it cannot be certain that these cases were due to B19 virus infection.

There have been occasional cases of B19 infection associated with a purpuric rash. In most the platelet count is normal (Lefrere *et al.*, 1985b) but thrombocytopenia has been recorded (Mortimer *et al.*, 1985). Sometimes the clinical diagnosis of Henoch-Schönlein purpura is made but it is unclear what percentage of cases of this condition are caused by B19. The purpura in cases of B19 infection is transient in these patients and there is no evidence that B19 causes idiopathic thrombocytopenic purpura.

Joint Involvement

The most common complication of B19 virus infection is joint involvement. It is relatively rare among children but in adult females it is commonplace, occurring in about 80% of infections with a rash. It is now also clear, with the widespread application of B19 diagnostic tests, that the joint involvement may occur in the absence of any evidence of a rash,

although there are no estimates of how frequent this is.

In adults the most common presentation is with a sudden onset of symmetrical arthritis affecting the small joints of the hand. Proximal interphalangeal and metacarpophalangeal joints are most often affected, followed by wrists, ankles, knees and elbows. Shoulders, cervical spine and lumbar spine as well as the hips may also be involved. There may be pain and stiffness in the joints, which may be accompanied by minor swelling or synovitis. In cases in which a rash occurs the joint involvement will have commenced 1–6 days after the onset of the rash. In children the joint involvement may be asymmetrical and symptoms seem more severe than in adults and may be of longer duration.

Important aspects of the B19 virus-associated arthropathy have been defined by two large studies (Reid *et al.*, 1985; White *et al.*, 1985). In a large outbreak of erythema infectiosum 42 patients presented with joint pain; 88% of the patients were female and 90% were adults. The arthritis was most frequently symmetrical and resolved within 4 weeks except in the occasional patient in whom it persisted for 6–7 months. In a second study B19 virus diagnostic tests were applied to 153 patients presenting to an early synovitis clinic over a period of approximately 1 year. Nineteen of these patients had evidence of recent B19 infection; all were adult females and there was a prodromal rash in only four. It is likely that this study selected the more severe cases of B19 arthropathy. Symptoms persisted for more than 2 months in 17, and for more than 4 years in three. More characteristically, about two-thirds of patients become symptom-free within 2 weeks of the onset and the majority were fully recovered in 4 weeks.

Occasional cases of B19 arthropathy could be classified as early benign rheumatoid arthritis. However, these cases are rheumatoid factor-negative and other evidence indicates that B19 is not the cause of rheumatoid arthritis. The frequency of B19 antibody is no greater in patients with seropositive rheumatoid arthritis and B19 seroconversion occurs in patients who have had rheumatoid arthritis for years (Lefrere *et al.*, 1985a).

Aplastic Crisis

An aplastic crisis is a transient, acute event that

complicates chronic haemolytic anaemia. It is characterized by a fall from steady-state values of haemoglobin concentration, disappearance of reticulocytes from peripheral blood and the absence of red blood cell precursors in the bone marrow. The cessation of erythropoiesis lasts 5–7 days and patients present with symptoms of worsening anaemia, namely fatigue, shortness of breath, pallor, lassitude, confusion and sometimes congestive cardiac failure. The event is serious in most patients and occasionally it is fatal. Blood transfusion is required in the acute phase but after about 1 week the bone marrow recovers rapidly. There is a reticulocytosis and the haemoglobin concentration returns to steady-state values.

The aetiological link between B19 virus infection and aplastic crisis was first noted in patients with sickle cell anaemia in 1981 (Serjeant *et al.*, 1981). Studies since then have shown that more than 90% of all cases of aplastic crises in patients with chronic haemolytic anaemia are due to B19 virus infection (Anderson *et al.*, 1982; Rao *et al.*, 1983; Kelleher *et al.*, 1984). Most cases occur in children under the age of 15 but adults who remain susceptible to the virus infection may have B19-associated aplastic crises in later life. B19-associated aplastic crises are not confined to patients with sickle cell anaemia but have occurred in those with hereditary spherocytosis (Kelleher *et al.*, 1983), pyruvate kinase deficiency (Duncan *et al.*, 1983), β -thalassaemia intermedia (Rao *et al.*, 1983) and the dyshaemopoietic anaemia, HEMPAS (West *et al.*, 1986).

B19 virus infection is worldwide in its distribution, and aplastic crises associated with the infection have been described in Europe, North America and the West Indies. The crises are an expression of the tropism of *B19 virus* for early erythroid precursors occurring in individuals whose haemoglobin is already low and whose red blood cells have a short lifespan of 15–20 days. In such circumstances an arrest of erythropoiesis in the marrow leads to a sharp fall in haemoglobin and symptoms of anaemia. However, virus infection does not invariably result in an aplastic crisis in patients with chronic haemolytic anaemia and even when it does occur the severity of the episode varies between individuals. This is likely to reflect variation in erythrocyte lifespan between patients but studies so far have failed to reveal an erythrocyte marker which is a good predictor of this.

B19 Infection in Pregnancy

Properties of *B19 virus*—production of a high-titre viraemia and a requirement for dividing host cells—suggest that infection of the placenta and fetus may occur if infection occurs during pregnancy. Moreover, animal parvoviruses cause fetal loss in hamsters (Kilham, 1961) and pigs (Mengeling, 1975) and there are specific diseases associated with parvovirus infection in late pregnancy in cats (Kilham and Margolis, 1966) and dogs (Jeffries and Blake-more, 1979). Thus the occurrence and effects of B19 virus infection in pregnancy have always been of interest.

The first aspect of the possible effects to be investigated was the relationship between B19 virus infection and birth defects. No excess of defects could be detected following clinically diagnosed outbreaks of erythema infectiosum (Ager *et al.*, 1966) and no B19 antigen or specific IgM could be detected in sera taken during the first month of life from infants with birth defects (Mortimer *et al.*, 1985). Finally, in a large prospective study of B19 infection in pregnancy (Public Health Laboratory Working Party on Fifth Disease, 1990) all pregnancies which reached term delivered a normal, healthy baby and all those that were followed to 1 year showed no serious problems. Thus there is no evidence to date that B19 causes birth defects, although it should be remembered that the sample sizes in the studies have been too small to detect a rare defect, i.e. one with a rate of 1% or less. Nevertheless there is no reason to recommend termination of pregnancies complicated by laboratory-proven B19 virus infection provided the pregnancy remains normal and there is no evidence of hydrops fetalis (see below).

Small studies have shown that laboratory-confirmed B19 infection does not occur as often as expected in pregnant women. This suggests that B19 infection may lead to early fetal loss, even before pregnancy is confirmed. There has been one large study (Public Health Laboratory Working Party on Fifth Disease, 1990) of the effect of confirmed B19 infection in women who are pregnancy test-positive but this UK study could not incorporate a control group. Analysis of the 190 cases entered into this study shows that fetal loss in the first trimester of pregnancies complicated by B19 infection was no greater than would be expected from historical controls (6% versus 5–12%). However,

there was a pronounced excess (12.4% versus 0.6%) of fetal loss in the second trimester of pregnancies complicated by B19 infection compared with those in a separate but comparable study in the UK. It thus appears that B19 infection is a significant cause of second trimester fetal loss. The pregnancy is lost most frequently 4–6 weeks after the onset of the rash illness in the mother.

Clearly the majority of pregnancies complicated by B19 continue to full-term delivery of normal infants. However, occasionally serious effects do occur as a consequence of second or third trimester infection, and fetal hydrops appears to be a consistent feature in these cases (Anand *et al.*, 1987; Anderson *et al.*, 1988). Maternal infection occurs 2–12 weeks prior to the diagnosis of hydrops fetalis. B19 is a likely cause if there is a low haemoglobin in the fetus in the absence of haemolytic disease. In a retrospective review of 50 cases of hydrops fetalis in a single department of pathology in the UK between 1974 and 1983 there was evidence of B19 infection in four (Porter *et al.*, 1988). Thus it is worth investigating B19 as a cause of non-immunological hydrops fetalis by specific tests for virus infection on fetal material, although raised maternal α -feto-protein levels are a marker of intrauterine B19 infection (Carrington *et al.*, 1987).

Intrauterine transfusion has been used to manage a number of cases of hydrops fetalis during pregnancy. Brown and colleagues (1994) describe three such cases who at birth were found to have hypogammaglobulinaemia, and viral DNA was present in the bone marrow, although absent from the serum. One child died but the other two remained persistently anaemic in spite of immunoglobulin therapy. The authors conclude that persistent B19 infection should be suspected in infants with congenital red-cell aplasia.

B19 Infection in the Immunosuppressed

A chronic B19 virus infection with associated anaemia occurs in immunocompromised individuals who have failed to produce neutralizing antibody to the virus. The anaemia is often severe and may be persistent or intermittent, with the viraemia disappearing during remission and reappearing when a patient relapses. The patients often require blood transfusions. The bone marrow picture is typical of

that seen in aplastic crises complicating haemolytic anaemia. Persistent parvovirus infection with associated anaemia has been seen in patients with congenital immunodeficiency (Nezelof's syndrome) (Kurtzman *et al.*, 1989), children with lymphoblastic leukaemia and other malignancies (Graeve *et al.*, 1989; Kurtzman *et al.*, 1989), patients with the acquired immune deficiency syndrome (Frickhofen *et al.*, 1990) and following renal transplantation (Nield *et al.*, 1986). Some of the patients have been given human normal immunoglobulin which contains B19 antibodies and this has led to a fall in virus titre, reticulocytosis and in some cases rash illness presumed to be due to immune complexes.

LABORATORY DIAGNOSIS

Aplastic crisis is the only one of the clinical syndromes which can be assumed, with some accuracy, to be due to B19 infection. Even so, in patients with chronic haemolytic anaemia moderate to severe degrees of hypoplasia may be associated with systemic bacterial infection or marrow-suppressive drugs, and anaemia in the immunocompromised may have many other causes. Illnesses associated with maculopapular rashes with or without joint involvement also have a multiplicity of causes and only a minority of cases of hydrops fetalis will prove to be due to B19 infection. Thus accurate diagnosis of B19 infection depends upon specific laboratory tests.

Specimens

Serum is the principal specimen used for the laboratory diagnosis of B19 infection (Pattison, 1995). This approach is suitable for virus detection in cases of aplastic crisis, persistent infection in immunosuppressed patients and persistent fetal infection. The detection of specific IgM antibody in serum is the cornerstone of the diagnosis of rash illness and arthropathy, and is also as valuable as virus detection in cases of aplastic crisis. Standard blood specimens are all that are required and no special arrangements are needed for transport to or storage in the laboratory. It should be remembered that viraemic samples contain much infectious virus. Care should be taken when handling samples, especially those

taken early in the course of an aplastic crisis, to ensure that seronegative individuals in the laboratory are not infected (probable cases of laboratory-acquired infection have been described; Cohen *et al.*, 1988). The most hazardous manipulations appear to be some of the washing steps necessary in the serological tests.

Detection of *B19 virus* by *in situ* hybridization can be performed on formalin-fixed, paraffin-embedded tissue, so that standard pathology protocols can be used for dealing with fetal tissue.

Virus Detection

With *B19 virus* the propagation *in vitro* in erythroid cells of human bone marrow and fetal liver remains a research technique. Otherwise many of the standard techniques for the detection of viruses in clinical practice have been applied to the diagnosis of B19 virus infection. CIE, electron microscopy and immune electron microscopy are valuable because they give a relatively rapid result. In addition visualization of the virus by electron microscopy can be a useful confirmatory test. The common clinical situation in which these tests are applied is to the acute-phase specimen of cases of aplastic crisis. CIE, which is capable of detecting approximately 10^8 – 10^9 particles ml^{-1} , will reveal virus in approximately 30% of cases in which a specimen is taken within 24 hours of the onset of symptoms. More sensitive methods for the detection of virus are radioimmunoassay or DNA hybridization using cloned viral genome labelled with ^{32}P (Cohen *et al.*, 1983; Anderson *et al.*, 1985b). Application of these techniques, which detect about 10^4 particles ml^{-1} , to specimens taken within 24 hours of the onset of an aplastic crisis will yield positive results in 60% of cases. Immune electron microscopy is only slightly less sensitive than this.

The most sensitive technique for the detection of virus requires amplification of the DNA using the PCR. These techniques, such as the nested PCR described by Patou and Ayliffe (1991), are capable of detecting 1–10 virus particles. This technique has not been applied to a series of cases of aplastic crisis but it is likely that almost all the sera would be positive if taken within a week of the onset of the infection. The technique has, however, been applied to a series of specimens submitted for diagnosis of

B19 infection from cases of rash, rash and arthralgia or arthralgia alone. The less sensitive techniques for virus detection would be negative in these cases because this occurs later in the course of infection when virus is present in the blood in only very low concentrations. However, in such cases the nested PCR was positive in 70% of samples. Nevertheless it did not diagnose any additional cases compared with a combination of dot-blot hybridization and anti-B19 IgM tests.

The diagnosis of B19 virus infection in a fetus also depends upon the detection of virus. Maternal infection will have occurred some weeks previously and maternal serum may therefore be B19-specific IgM negative. In most instances the fetus has also been found to be specific IgM negative but there is frequently a persistent viraemia. Therefore the diagnosis is best made by detection of virus in fetal blood samples by the techniques described above. Equally virus can be detected in fetal tissues taken at autopsy from which DNA has been extracted or detected by *in situ* hybridization on formalin-fixed, paraffin-embedded tissue sections. Biotin (Figure 24.7) and digoxigenin (Morey *et al.*, 1992) have been evaluated for this purpose. The latter seems more reliable when studying archival fetal tissues since false positives may be obtained with biotinylated probes. If tissue samples such as placenta are extracted and tested for B19 DNA, confirmation by Southern blotting with and without endonuclease restriction is mandatory, since weak, false-positive dot-blot signals do occur with such samples.

Specific Antibody Detection

Standard solid-phase radiolabelled or enzyme-labelled immunoassays are the preferred methods for the serological diagnosis of B19 infection. If these techniques are not available then CIE and immune electron microscopy may be used as relatively insensitive tests of seroconversion.

Current tests for class-specific B19 antibody (Cohen *et al.*, 1983) employ the antibody capture principle in which class-specific antibody in the patient's serum is bound by a solid phase coated with antibody to human μ or γ chains. The viral specificity of the bound antibody is determined by the addition of B19 virus antigen to the solid phase. In turn bound antigen is detected by the addition of mono-

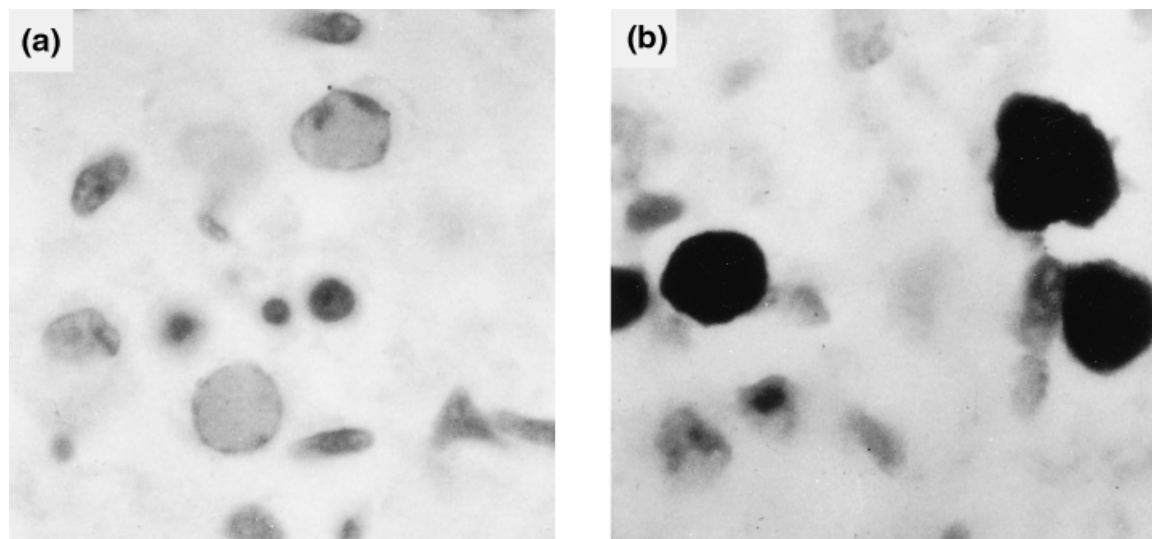

Figure 24.7 Spleen from a fetus with hydrops fetalis stained with haematoxylin and eosin (a) and probed with a biotinylated B19 probe (b). Stain (a) reveals intranuclear inclusion bodies with margination of the nuclear chromatin and (b) shows that these cells contain B19 virus DNA. (Adapted with permission from Parvoviruses: medical and biological aspects, Pattison, J.R. in *Fields Virology*, 2nd edition 1990, p 1771)

clonal anti-B19 antibody, which may itself be tagged with enzyme or radiolabel. Alternatively an extra step may be incorporated whereby the bound monoclonal anti-B19 is detected by the addition of labelled antimouse immunoglobulin. Diagnosis using these tests is dependent upon either the detection of B19-specific IgM or a significant change in the amount of B19-specific IgG present in paired sera. As yet there are no national or international standard sera for B19 antibody tests so that laboratories offering a diagnostic service usually report their results in arbitrary units (au) by comparison with a local control serum. The quantification is based on designating a highly reactive serum as containing 100 au and including a set of standards in each test.

Sera containing 10 au or more of anti-B19 IgM are unequivocally associated with recent infection. This relatively high threshold is set because sera containing high concentrations of antirubella virus IgM may give low false-positive results when tested for anti-B19 IgM, and vice versa (Kurtz and Anderson, 1985). This must be borne in mind when testing sera taken within 2 weeks of a rubelliform illness. However, high concentrations of anti-B19 IgM usually appear within 3–4 days of the onset of symptoms. In a recent series of aplastic crises from Jamaica (unpublished data), > 100 au IgM were present in over 50% of patients in whom the serum

was taken on the day of onset of the aplastic crisis. An even higher percentage of cases of rash illness due to B19 will have such concentrations of specific IgM in sera taken when the patient first presents. However, in occasional cases (particularly of aplastic crisis) specific IgM may not appear until 7–10 days after the onset. Therefore if a negative result for anti-B19 IgM is obtained with a serum taken within 10 days of the onset of the illness, this serum should be tested for viral DNA and/or a second specimen to be taken about 14 days after the onset of symptoms should be requested. Specific IgM is detectable for 2–3 months after acute infection. Interpretation of equivocal low concentrations of anti-B19 IgM in sera taken after this time is difficult and in this circumstance testing for IgG may be helpful.

In the 12 months following infection patients have relatively high (< 50 au) concentrations of anti-B19 IgG and the finding of such concentrations supports the diagnosis of infection during that time. However, there is marked individual variation in the maximum amounts of specific IgG that can be demonstrated in a patient, so that the finding of only low values (> 20 au) does not exclude recent infection. The assay used for the detection of anti-B19 IgG is a capture assay and a positive signal therefore depends on a minimum proportion of the total IgG being B19 specific. Sera with low concen-

trations may not bind sufficient antigen to be detected by the indicator antibody and therefore the anti-B19 IgG capture assay is not a sensitive test of past exposure to the virus. Previous infection (and therefore immunity in most individuals) is indicated by the detection of > 1 au of anti-B19 IgG, provided that the test serum:negative serum ratio is > 2 . However, a negative result cannot be taken to be synonymous with susceptibility.

There is a poor humoral immune response in immunocompromised patients with chronic parvovirus infection and only low concentrations of anti-B19 IgG (and IgM) can be detected in these patients. None of the detectable antibody neutralizes virus infectivity and this is taken to be an essential component of the pathogenesis of the chronic infection.

TREATMENT AND PREVENTION

There is no specific antiviral chemotherapy for B19 infection. Symptomatic relief of troublesome joint symptoms may be required for *B19 virus*-associated arthralgia, and blood transfusion may be necessary in the acute phase of aplastic crisis.

The only specific treatment for B19 infection is the intravenous administration of human immunoglobulin in cases of persistent infection in the immunocompromised. Human normal immunoglobulin preparations are a good source of neutralizing antibodies to *B19 virus*, since at least half the adult population have been exposed to the virus. Controlled trials have not been done but on an empirical basis the administration of 0.4 g kg^{-1} body weight per day for 5–10 days has proved effective in reducing viraemia and allowing the haemoglobin to return to near-normal values (Kurtzman *et al.*, 1989; Frickhofen *et al.*, 1990). Patients sometimes relapse months later but they have been shown to respond to repeat courses. If relapse occurs less than 6 months after the initial treatment then the current recommendation is to give maintenance therapy of 0.4 g kg^{-1} body weight once every 4 weeks (Frickhofen *et al.*, 1990).

Prevention of disease by isolating susceptible individuals is impractical because infections may be subclinical, and even symptomatic individuals are most frequently infectious before any sign of illness. Theoretically, susceptible individuals with chronic

haemolytic anaemia (or immunocompromised children) could be temporarily protected by the administration of human immunoglobulin but to date this has not been put into practice.

The prevention of parvovirus infections in animals by vaccination is standard practice in veterinary medicine. In the case of *B19 virus* it is unlikely that sufficiently large quantities of native virus will ever be produced in cell culture systems. However, self-assembling B19 virus capsids have been produced by recombinant DNA technology using a baculovirus system (Kajagiya *et al.*, 1991; Bansal *et al.*, 1992). These genetically engineered capsids are antigenically and immunogenically similar to native virions and induce neutralizing antibodies. The presence of VP1 in the capsid immunogen appears critical for the production of neutralizing antibodies, and capsids with more than the normal VP1 content are more efficient in producing such antibody (Dr N.S. Young, personal communication). Thus it seems possible that a B19 virus vaccine will be available in the near future and decisions on whether or how to use it will need to be made.

REFERENCES

- Agbandje, M., McKenna, R., Rossmann, M.G. *et al.* (1994) The structure of human parvovirus B19 at 8 \AA resolution. *Virology*, **203**, 106–115.
- Ager, E.A., Chin, T.D.Y. and Poland, J.P. (1966) Epidemic erythema infectiosum. *New England Journal of Medicine*, **275**, 1326–1331.
- Anand, A., Gray, E.S., Brown, T. *et al.* (1987) Human parvovirus infection in pregnancy and hydrops fetalis. *New England Journal of Medicine*, **316**, 183–186.
- Anderson, M.J. and Pattison, J.R. (1985) The human parvovirus. *Archives of Virology*, **82**, 137–148.
- Anderson, M.J., Davies, L.R., Hodgson, S.E. *et al.* (1982) Occurrence of infection with a parvovirus-like agent in children with sickle cell anaemia during a two-year period. *Journal of Clinical Pathology*, **35**, 744–749.
- Anderson, M.J., Lewis, E., Kidd, I.M. *et al.* (1984) An outbreak of erythema infectiosum associated with human parvovirus infection. *Journal of Hygiene*, **93**, 85–93.
- Anderson, M.J., Higgins, P.G., Davis, L.R. *et al.* (1985a) Experimental parvovirus infection in man. *Journal of Infectious Diseases*, **152**, 257–265.
- Anderson, M.J., Jones, S.E. and Minson, A.C. (1985b) Diagnosis of human parvovirus infection by dot-blot hybridization using cloned viral DNA. *Journal of Medical Virology*, **15**, 163–172.
- Anderson, M.J., Khousam, M.N., Maxwell, D.F. *et al.* (1988) Human parvovirus B19 and hydrops fetalis (letter). *Lancet*, **i**, 535.
- Bansal, G.P., Hatfield, J., Dunn, F.E. *et al.* (1992) Immunogenic-

- ity studies of recombinant human parvovirus B19 proteins. *Vaccines*, **167**, 1034–1044.
- Brown, K.E. and Young, N.S. (1997) The simian parvoviruses. *Review of Medical Virology*, **7**, 211–218.
- Brown, K.E., Anderson, S.M. and Young, N.S. (1993) Erythrocyte P antigen cellular receptor for B19 parvovirus. *Science*, **262**, 114–117.
- Brown, K.E., Green, S.W., Antunez de Mayolo, J. *et al.* (1994) Congenital anaemia after transplacental B19 parvovirus infection. *Lancet*, **i**, 895–896.
- Carrington, D., Whittle, M.J., Gibson, A.A.M. *et al.* (1987) Maternal serum α -fetoprotein—a marker of fetal aplastic crises during intrauterine human parvovirus infection. *Lancet*, **i**, 433–435.
- Cohen, B.J., Mortimer, P.P. and Pereira, M.S. (1983) Diagnostic assays with monoclonal antibodies for the human serum parvovirus-like virus (SPLV). *Journal of Hygiene*, **91**, 113–130.
- Cohen, B.J., Courouce, A.-M., Schwartz, T.F. *et al.* (1988) Laboratory infection with parvovirus B19. *Journal of Clinical Pathology*, **44**, 1027–1028.
- Cossart, Y.E., Field, A.M., Cant, B. *et al.* (1975) Parvovirus-like particles in human sera. *Lancet*, **i**, 72–73.
- De Freitas, R.B., Wong, D., Boswell, F. *et al.* (1990) Prevalence of human parvovirus (B19) and rubellavirus infections in urban and remote rural areas in northern Brazil. *Journal of Medical Virology*, **32**, 203–208.
- Deiss, V., Tratschin, J.-D., Weitz, M. *et al.* (1990) Cloning of the human parvovirus B19 genome and structural analysis of its palindromic terrain. *Virology*, **175**, 247–254.
- Duncan, J.R., Capellini, M.D., Anderson, M.J. *et al.* (1983) Aplastic crisis due to parvovirus infection in pyruvate kinase deficiency. *Lancet*, **ii**, 14–16.
- Frickhofen, N., Abkowitz, J., Safford, M. *et al.* (1990) Persistent parvovirus infection in patients infected with human immunodeficiency virus-1: a treatable cause of anaemia in AIDS. *Annals of Internal Medicine*, **113**, 926–933.
- Graeve, J.L.A., de Alarcon, P.A. and Naides, S.J. (1989) Parvovirus B19 infection in patients receiving cancer chemotherapy: the expanding spectrum of diseases. *American Journal of Pediatric Hematology/Oncology*, **11**, 441–444.
- Grilli, E.A., Anderson, M.J. and Hoskins, T.W. (1989) Concurrent outbreaks of influenza and parvovirus B19 in a boys' boarding school. *Epidemiology and Infection*, **103**, 359–370.
- Jeffries, A.R. and Blakemore, W.F. (1979) Myocarditis and enteritis in puppies associated with parvovirus. *Veterinary Record*, **104**, 221.
- Kajigaya, S., Fujii, H., Field, A.M. *et al.* (1991) Self assembled B19 parvovirus capsids, produced in a baculovirus system, are antigenically and immunologically similar to native virions. *Proceedings of the National Academy of Sciences of the USA*, **88**, 4646–4650.
- Kelleher, J.F., Mortimer, P.P. and Kanimura, T. *et al.* (1983) Human serum 'parvovirus' a specific cause of aplastic crisis in hereditary spherocytosis. *Journal of Pediatrics*, **102**, 720.
- Kelleher, J.F., Luban, N.L.C., Cohen, B.J. *et al.* (1984) Human serum parvovirus as the cause of aplastic crisis in sickle cell diseases. *American Journal of Diseases of Children*, **138**, 401–403.
- Kilham, L. (1961) Mongolism associated with rat virus (RV) infection in hamsters. *Virology*, **13**, 141.
- Kilham, L. and Margolis, G. (1966) Spontaneous hepatitis and cerebellar hypoplasia in suckling rats due to congenital infection with rat virus. *American Journal of Pathology*, **49**, 457.
- Koch, W.C. and Adler, S.P. (1990) Detection of human parvovirus B19 by using a polymerase chain reaction. *Journal of Clinical Microbiology*, **28**, 65–69.
- Kurtz, J.B. and Anderson, M.J. (1985) Cross-reaction in rubella and parvovirus specific IgM tests. *Lancet*, **ii**, 1356.
- Kurtzman, G., Cohen, B., Myers, P. *et al.* (1988) Persistent B19 parvovirus infection as a cause of severe anemia in children with acute lymphocytic leukemia in remission. *Lancet*, **ii**, 1159–1162.
- Kurtzman, G., Cohen, R., Field, A.M. *et al.* (1989) The immune response to B19 parvovirus infection and an antibody defect in persistent viral infection. *Journal of Clinical Investigation*, **84**, 1114–1123.
- Lefrere, J.-J., Meyer, O., Nekes, C.-J. *et al.* (1985a) Human parvovirus and rheumatoid arthritis. *Lancet*, **i**, 982.
- Lefrere, J.-J., Courouce, A.-M., Muller, M. *et al.* (1985b) Human parvovirus and purpura. *Lancet*, **ii**, 730.
- Luo, W. and Astell, C.R. (1993) A novel protein encoded by small RNAs of parvovirus B19. *Virology*, **195**, 448–455.
- Lyon, D.J., Chapman, C.S., Martin, C. *et al.* (1989) Symptomatic parvovirus B19 infection and heat-treated factor IX concentrate. *Lancet*, **i**, 1085.
- Mengeling, W.L. (1975) Porcine parvovirus: frequency of naturally occurring transplacental infection and viral contamination of fetal porcine kidney cell cultures. *American Journal of Veterinary Research*, **36**, 41.
- Morey, A.L., Porter, H.J., Keeling, J.W. *et al.* (1992) Non-isotopic *in situ* hybridization and immunophenotyping of infection cells in the investigation of human fetal parvovirus infection. *Journal of Clinical Pathology*, **45**, 673–678.
- Mortimer, P.P., Humphries, R.K., Moore, J.G. *et al.* (1983) A human parvovirus-like virus inhibits haemopoietic colony formation *in vitro*. *Nature*, **302**, 426–429.
- Mortimer, P.P., Cohen, B.J., Buckley, M.M. *et al.* (1985) Human parvovirus and the fetus. *Lancet*, **ii**, 1012.
- Nield, G., Anderson, M., Hawes, S. *et al.* (1986) Parvovirus infection after renal transplant (letter). *Lancet*, **ii**, 1227–1227.
- Nishizawa, T., Okamoto, H., Konishi, K. *et al.* (1997) A novel DNA virus (TTV) associated with elevated transaminase levels in posttransfusion hepatitis of unknown etiology. *Biochemical and Biophysical Research Communications*, **241**, 92–97.
- Okamoto, H., Nishizawa, T., Kato, N. *et al.* (1998) Molecular cloning and characterization of a novel DNA virus (TTV) associated with posttransfusion hepatitis of unknown etiology. *Hepatology Research*, **10**, 1–16.
- Owen, P.A. (1948) Congenital hemolytic jaundice: the pathogenesis of the 'hemolytic crisis'. *Blood*, **3**, 231–248.
- Ozawa, K., Ayud, J., Yu-shu, H. *et al.* (1987a) Novel transcription map for the B19 (human) pathogenic parvovirus. *Journal of Virology*, **61**, 2395–2406.
- Ozawa, K., Kurtzman, G. and Young, N. (1987b) Productive infection by B19 parvovirus of human erythroid bone marrow cells *in vitro*. *Blood*, **70**, 384–391.
- Ozawa, K., Ayub, J., Kajigaya, S. *et al.* (1988) The gene encoding the nonstructural protein of B19 (human) parvovirus may be lethal in transfected cells. *Journal of Virology*, **62**, 2884–2889.
- Patou, G. and Ayliffe, U. (1991) Evaluation of commercial enzyme linked immunosorbent assay for detection of B19 parvovirus IgM and IgG. *Journal of Clinical Pathology*, **44**,

- 851–854.
- Pattison, J.R. (1995) Human parvoviruses. In *Manual of Clinical Microbiology*, 6th edn (eds P.R. Murray, E.J. Baron, M.A. Tenover, Pfaller *et al.*), pp 974–979. ASM Press, Washington DC.
- Paver, W.K., Caul, E.O., Ashley, C.R. *et al.* (1973) A small virus in human faeces. *Lancet*, **i**, 664–665.
- Plummer, A.F., Hammond, W.G. and Forward, K. (1985) An erythema infectiosum-like illness caused by human parvovirus infection. *New England Journal of Medicine*, **313**, 74–79.
- Porter, H.J., Khong, T.Y., Evans, M.F. *et al.* (1988) Parvovirus as a cause of hydrops fetalis: detection by *in situ* DNA hybridization. *Journal of Clinical Pathology*, **41**, 381–383.
- Public Health Laboratory Working Party on Fifth Disease (1990) Prospective study of human parvovirus (B19) infection in pregnancy. *BMJ*, **300**, 1166–1170.
- Rao, K.R.P., Patel, A.R., Anderson, M.J. *et al.* (1983) Infection with a parvovirus-like virus and aplastic crisis in chronic haemolytic anaemia. *Annals of Internal Medicine*, **980**, 930–932.
- Reid, D.M., Reid, T.M.S., Brown, T. *et al.* (1985) Human parvovirus-associated arthritis: a clinical and laboratory description. *Lancet*, **ii**, 422–425.
- Schwarz, L., Gurtler, L.G., Zoulek, G. *et al.* (1989) Seroprevalence of human parvovirus B19 infection. *International Journal of Medical Microbiology*, **271**, 231–236.
- Serjeant, G.R., Topley, G.M., Mason, K. *et al.* (1981) Outbreak of aplastic crisis in sickle-cell anaemia associated with parvovirus-like agent. *Lancet*, **ii**, 595–598.
- Shade, R.O., Blundell, M.C., Cotmore, S.F. *et al.* (1986) Nucleotide sequence and genome organization of human parvovirus B19 isolated from the serum of a child during aplastic crisis. *Journal of Virology*, **58**, 921–936.
- Shimomura, S., Komatsu, N., Frickhofen, N. *et al.* (1992) First continuous propagation of B19 parvovirus in a cell line. *Blood*, **79**, 18–24.
- Srivastava, A., Bruno, E., Briddell, R. *et al.* (1990) Parvovirus B19-induced perturbation of human megakaryocytopoiesis *in vitro*. *Blood*, **76**, 1997–2004.
- Summers, J., Jones, S.E. and Anderson, M.J. (1983) Characterization of the agent of arethrocye aplasia as a human parvovirus. *Journal of General Virology*, **64**, 2527–2532.
- Takahashi, T., Ozawa, K., Mitani, K. *et al.* (1989) B19 parvovirus replicates in erythroid leukaemic cells *in vitro*. *Journal of Infectious Diseases*, **160**, 548–549.
- Tsao, J., Chapman, M.S., Agbandje, M. *et al.* (1991) The three-dimensional structure of canine parvovirus and its functional implications. *Science*, **251**, 1456–1464.
- West, N.C., Meigh, R.E., Mackie, M. *et al.* (1986) Parvovirus infection associated with aplastic crisis in a patient with HEMPAS. *Journal of Clinical Pathology*, **37**, 1144.
- White, D.G., Mortimer, P.P., Blake, D.R. *et al.* (1985) Human parvovirus arthropathy. *Lancet*, **i**, 419–421.
- Williams, M.D., Beddall, A.C., Pasi, K.J. *et al.* (1990) Transmission of human parvovirus B19 by coagulation factor concentrates. *Vox Sanguinis*, **58**, 177–181.
- Yaegashi, N., Shiraishi, H., Takeshita, T. *et al.* (1989) Propagation of human parvovirus B19 in primary culture of erythroid lineage cells derived from fetal liver. *Journal of Virology*, **63**, 2422–2426.
- Young, N.S. (1996) Parvovirus. In *Fields Virology*, 3rd edn (eds B.N. Fields, D.M. Knipe, P.M. Howley), pp 2199–2214. Lippincott-Raven, Philadelphia.
- Young, N.S., Mortimer, P.P., Moore, J.G. *et al.* (1984) Characterization of a virus that causes transient aplastic crisis. *Journal of Clinical Investigation*, **73**, 224–230.

Human Immunodeficiency Viruses

Robin A. Weiss

Royal Free and University College Medical School, London, UK

Angus G. Dalgleish

St George's Hospital Medical School, London, UK

and

Clive Loveday

Royal Free and University College Medical School, London, UK

INTRODUCTION TO HUMAN RETROVIRUSES

Retroviruses occur in numerous vertebrates species and are associated with a diversity of diseases. Studies of animals have shown that retroviruses cause a wide variety of neoplasms, many with human counterparts. Leukaemia and sarcomas in chickens were first identified as having a viral aetiology from 1908, and retroviruses were later found to be associated with malignant disease in mice, cats, primates and other hosts, including fish. Apart from malignancy, retroviruses are associated with other disease, including autoimmune disease, immunodeficiency syndromes, aplastic and haemolytic anaemias, bone and joint disease (osteopetrosis and arthritis) and neuropathy (Table 25.1). A comprehensive text covers most aspects of the biology and molecular biology of animal and human retroviruses (Coffin *et al.*, 1997).

Retroviruses are a single taxonomic group of RNA viruses that encode RNA-directed DNA polymerase (reverse transcriptase, RT). Upon infection, this enzyme catalyses the synthesis of a double-

stranded virion DNA. The provirus subsequently becomes integrated into host chromosomal DNA and serves as a template for viral genomic and messenger RNA transcription by the host cell's RNA synthetic and processing systems (Figure 25.1). Other special features of retroviruses include a diploid RNA genome, high frequency of intermolecular recombination between related viruses

Table 25.1 Disease caused by retroviruses in animals

Disease	Species affected
Leukaemia	Avian, mouse, cat, primates
Lymphoma	Avian, mouse, cat, primates, fish
Carcinoma	Mouse (mammary), chicken (renal)
Sarcoma	Rat, chicken, fish
Anaemia, aplasia	Cat, horse
Wasting and autoimmune disorders	Cat, primates, sheep, mouse SLE-like illness
Nervous system	Sheep, goat, mouse
Osteopetrosis	Chicken
Arthritis	Goat

SLE = systemic lupus erythematosus.

A wide variety of diseases are caused by animal retroviruses with familiar human counterparts of unknown aetiology. The major associations are listed above.

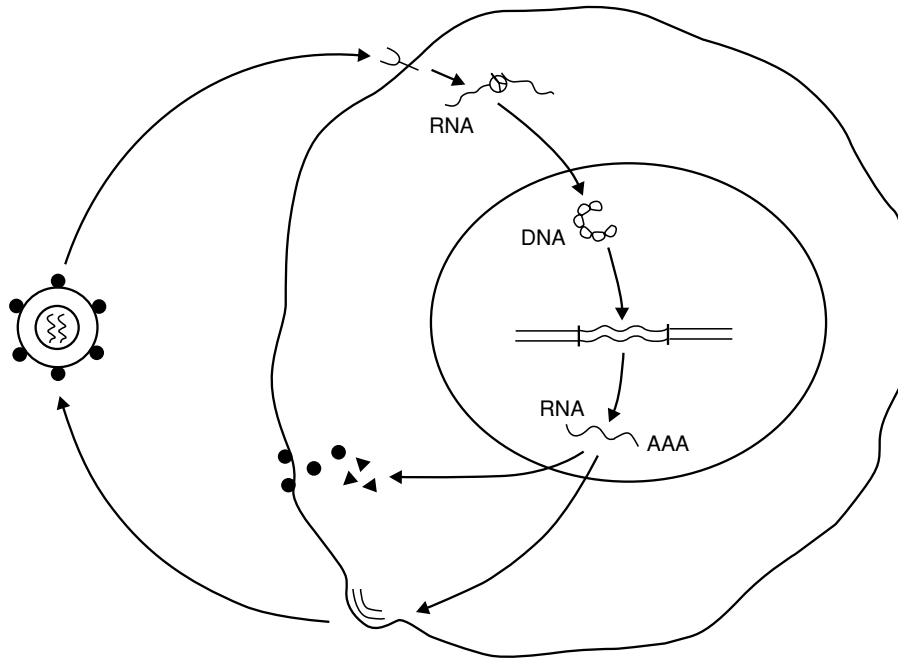

Figure 25.1 Simplified replication cycle of a retrovirus. The virion containing two RNA genome copies enters the virus via a specific cell surface receptor. The single-stranded RNA genome is converted into a double-stranded NA provirus by the virion enzyme reverse transcriptase. The provirus inserts into host chromosomal DNA in the same orientation as the original virion RNA. Transcription of RNA from the integrated DNA provirus is mediated by cellular RNA polymerases, and this RNA serves both as messenger RNA for the synthesis of viral antigens and as genomic RNA which becomes packaged into progeny virion budding from the cell surface

and the ability to acquire host genes which encode functions responsible for neoplastic transformation (oncogenes). There also exist endogenous proviruses in the normal cellular DNA of many vertebrates, which represent 'fossil' infections of the germline and which are passed from generation to generation in a mendelian manner.

All retroviruses carry at least three genes in the order $5'$ -*gag-pol-env*- $3'$. *Gag* encodes a precursor protein which is cleaved to yield three or four structural core and matrix proteins; *pol* encodes the reverse transcriptase, protease and integrase, synthesized from a *gag-pol* precursor; and *env* encodes a precursor cleaved to form the two disulphide-linked envelope proteins. The core proteins are often named by molecular weight (e.g. p24 and p17 of HIV). The outer surface protein is glycosylated and is known as gp120 (e.g. for HIV with an approximate molecular weight of 120 000) or gp70 (e.g. mammalian C-type oncoviruses). The anchored transmembrane protein, to which the surface protein is bound, is glycosylated in some retroviruses (e.g. gp41 of HIV) but not others (e.g. p15E of C-type oncoviruses). The genome is capped by long

terminal repeats at both ends and the RNA form by a polyadenylate tract at the $3'$ end. The long terminal repeats are responsible for integration of the DNA provirus with cellular DNA, and contain important promoter and enhancer sequences which bind cellular and viral proteins regulating viral gene expression.

CLASSIFICATION OF RETROVIRUSES

Retroviruses were taxonomically divided into three subfamilies: the *Oncovirinae*, which include those with oncogenic potential; the *Lentivirinae*, including HIV, and the prototype *Visna virus* of sheep which causes slow, progressive degeneration of the central nervous system; and the *Spumavirinae*, or foamy viruses, which have not been shown to be pathogenic. More recently, retroviruses of higher vertebrates have been classified into seven distinct groups by dividing oncoviruses into five, as they are only distantly related by genome sequence and morphology (Figure 25.2 and Table 25.2). More

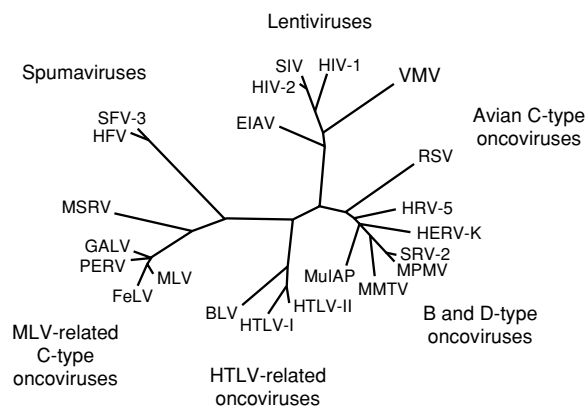

Figure 25.2 Phylogenetic tree of retroviruses

generally, retroviruses are divided into those with ‘simple’ genomes, having *gag*, *pol* and *env* genes and perhaps one other, and those with ‘complex’ genomes, also possessing regulatory genes such as *tat* and *rev* of HIV and *tax* of HTLV and accessory genes, such as *nef*, *vif* and *vpr* of HIV.

Five groups of retrovirus have been reported as human infections but only the first will be described in detail in this chapter:

1. *Human immunodeficiency virus types 1 and 2* (HIV-1 and HIV-2) are the lentiviruses that cause acquired immune deficiency syndrome (AIDS). Before the term HIV was coined in 1986, HIV was called lymphadenopathy virus (LAV) or HTLV-III. HIV and AIDS are the main topic of this chapter.
2. *Human T-lymphotropic virus types 1 and 2* (HTLV-1 and HTLV-2), cause adult T-cell leukaemia and neurological disease. They are reviewed in Chapter 25A.
3. *Human foamy virus* (HFV) is a spumavirus orig-

inally detected in cultured nasopharyngeal carcinoma of a Kenyan patient (Achong *et al.*, 1971). Because the HFV genome is indistinguishable from the of the *Simian foamy virus type 6* (SFV-6) of chimpanzees, it may represent a single case of zoonosis (Rosenblum and McClure, 1999). Serological studies indicate that human populations are not infected by spumaviruses (Ali *et al.*, 1996), although they are endemic in many primate species. Zoonotic SFV infection without symptoms has been recorded in primate handlers who have suffered bites or deep puncture wounds (Heineine *et al.*, 1998).

4. *Human retrovirus 5* (HRV-5) is a retroviral genome occurring at very low viral load in normal subjects but particularly in patients with arthritis and systemic lupus erythematosus (Griffiths *et al.*, 1999). The virus has not yet been propagated *in vitro*; its genome is related to the B-type and D-type retroviruses (Figure 25.2).
5. *Human endogenous retroviruses* (HERV) are mendelian loci in human chromosomes representing ‘fossil’ infections of the germline. These endogenous genomes derive from mammalian C-type and D-type (HERV-K) retroviruses. No lentiviruses or spumaviruses are known to have become endogenous. HERV genomes are defective, that is, human endogenous retroviral genomes have not been rescued in infectious form, in contrast to BaEV of baboons and PERV of pigs, which threaten the safety of human xenotransplantation from these sources (Weiss, 1998). Some HERV genomes, however, express envelope and other proteins, for example ERV-3 in the human placenta (Venables *et al.*, 1995; Löwer *et al.*, 1996), HERV-K in type 1 diabetes (Conrad *et al.*, 1997) and a HERV-W genome, MSR, in multiple sclerosis (Perron *et al.*, 1997).

Table 25.2 Classification of retroviruses of higher vertebrates

Group	Example	Virion ^a	Genome
1. Lentiviruses	<i>Human immunodeficiency virus</i>	Cone-shaped core	Complex
2. Human T-lymphotropic-related viruses	<i>Human T-cell leukaemia virus</i>	Central spherical core	Complex
3. Avian leucosis and sarcoma viruses	<i>Rous sarcoma virus</i>	Central spherical core; C-type	Simple
4. Murine leukaemia-related viruses	<i>Moloney leukaemia virus</i>	Central spherical core; C-type	Simple
5. Mammalian B-type viruses	<i>Mouse mammary tumour virus</i>	Eccentric spherical core; B-type	Simple
6. Mammalian D-type viruses	<i>Simian retrovirus type 1</i>	Cylindrical core; D-type	Simple
7. Spumaviruses	<i>Simian foamy virus</i>	Central spherical core; pronounced envelope spikes	Complex

^a B-type, D-type and spumaviruses have condensed cores visible in the cytoplasm of infected cells, whereas in the other retroviruses the cores condense as crescent-shaped bodies during maturation and budding at the cell membrane.

HISTORY OF AIDS

The acquired immune deficiency syndrome (AIDS) first came to the notice of physicians and epidemiologists in 1981 in USA when a handful of homosexual men in cities presented with *Pneumocystis carinii* pneumonia and Kaposi's sarcoma (KS). These diseases were previously extraordinarily rare in young adults and indicated that some kind of immune deficiency was occurring in gay men. The first full case description already showed a selective depletion of CD4⁺, T-helper lymphocytes in the peripheral blood (Gottlieb *et al.*, 1981).

It was soon noted that a larger proportion of gay men suffered from generalized, extended lymphadenopathy. The disease was initially called gay compromise syndrome. By early 1982, however, investigators at the Centers for Disease Control in Atlanta, USA, detected similar cases of what we now call AIDS among injecting drug users, and recipients of blood transfusions and blood products, especially of pooled clotting factors administered for haemophilia. These observations indicated that AIDS was not simply a consequence of gay life style, but was caused by an infectious agent spreading by sexual and parenteral transmission. Similar signs and symptoms to AIDS were recorded in Haiti, Europe and Africa.

Various candidate microbes were postulated as the cause of AIDS, including HTLV, *African swine fever virus*, and a possible fungal infection secreting an immunosuppressive factor like cyclosporin. The first HIV isolates were variously called HTLV-III, lymphadenopathy virus and AIDS-retrovirus (ARV). The term *Human immunodeficiency virus* was adopted in 1986.

Retrospective serological surveys indicated that HIV-1 began to spread among American gay men from 1977 onwards, showing a considerable incubation period before the manifestation of AIDS. The earliest known positive blood sample was collected in 1959 in Zaire (Zhu *et al.*, 1998).

CLASSIFICATION OF HIV

HIV-1 was first isolated in 1983 (Barré-Sinoussi *et al.*, 1983), just 2 years after the identification of AIDS. Further, independent HIV-1 isolates were reported in 1984 (Gallo *et al.*, 1984; Levy *et al.*,

1984), which, together with serology (Cheingsong-Popov *et al.*, 1984), made a convincing case for HIV as the cause of AIDS.

HIV-1 and HIV-2 represent two separate epidemics with distinct origins. HIV-1 probably started as a zoonosis from the chimpanzee, which harbours a related lentivirus, SIVcpz (Gao *et al.*, 1999), whereas HIV-2, first isolated in 1986 (Clavel *et al.*, 1986), clearly came from sooty mangabey monkeys in West Africa (Gao *et al.*, 1992).

HIV-1 is divided into three groups, the main group (M), the new group (N) and the outlier group (O). These groups may represent three separate zoonotic transfers from the chimpanzee (Gao *et al.*, 1999). Groups N and O remain largely confined to a part of West Central Africa (Gabon and Cameroon), although sporadic infection through contact with persons from that region occur. Group M has radiated widely to cause the worldwide AIDS pandemic. The HIV-1 subtypes or clades lettered A to J all belong to group M. The genomic and antigenic variation manifest by HIV-1 groups and subtypes is important for diagnostic virology based on genomic and serological assays.

HIV-1 and HIV-2 strains can also be classified according to phenotype, which does not relate directly to their major genotypic classification. Thus within each HIV-1 subtype there are virus isolates that are syncytium inducing (SI) (Figure 25.3) or are non-syncytium inducing (NSI) for CD4 cells *in vitro*. Most primary, transmitting HIV-1 strains have an NSI phenotype, while SI substrains tend to appear in infected individuals later as they progress to AIDS. As described later, this phenotypic classification is related to cellular tropism for macrophages of T cell lines and to which kind of chemokine coreceptor the virus uses to gain entry into cells. Most NSI strains utilize the CCR5 coreceptor and are known as R5 viruses, whereas most SI strains utilize the CXCR4 coreceptor and are known as X4 viruses (Berger *et al.*, 1998).

EPIDEMIOLOGY

As mentioned, in 1981 a handful of cases of *Pneumocystis carinii* pneumonia and of Kaposi's sarcoma in young homosexual men in the USA heralded the beginning of the AIDs era. Before HIV-1 was first isolated (Barré-Sinoussi *et al.*, 1983) it was

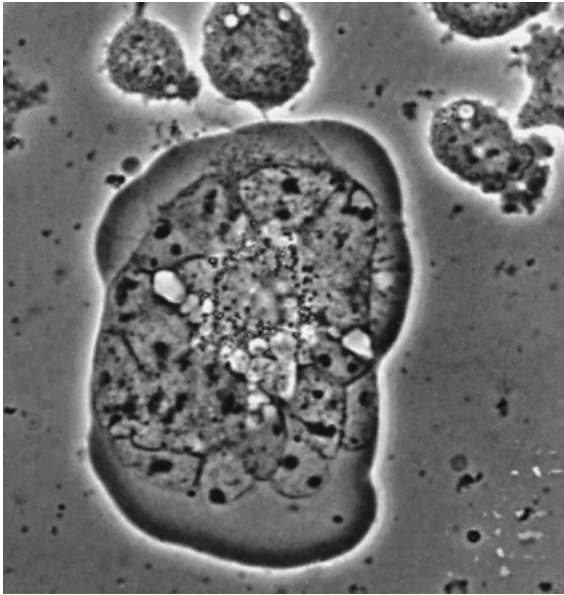

Figure 25.3 Phase-contrast micrograph of a giant syncytial cell formed 6 hours after mixing, 10% producing M7-H9 cells with 90% JM (Jurkat) indicator cells

already clear that the causative agent of AIDS was transmitted sexually and parenterally, and it soon became clear that mother-to-child transmission also occurred. With HIV serology it became evident that 'slim' disease in Africa was also AIDS (Serwadda *et al.*, 1985), as well as outbreaks in Europe and Haiti, so the international dimension opened on what had been first thought of as a disease of western gay men.

In the early stages of the AIDS epidemic, the main risk groups for HIV infection in western countries were gay men practising anal sexual intercourse, men and boys with haemophilia who were exposed to contaminated clotting factors, recipients of blood transfusion, and intravenous injecting drug users. However, in Africa and when it spread to Asia, HIV has from the beginning been heterosexually transmitted, affecting men and women alike. With the rapid introduction of screening following the development of commercial antibody tests in 1985, HIV infection through blood and blood products virtually disappeared, although this remains a problem in countries where screening is not stringent. 'Safe' practices have also helped to reduce sexual transmission, and antiviral drug treatment can markedly reduce perinatal transmission.

Nevertheless, HIV continues to spread, and some

Table 25.3 Global estimates of HIV infection in adults and children (end of 1998)

	Millions
People living with HIV/AIDS	33.4
New HIV infections in 1998	5.8
Deaths due to HIV/AIDS in 1998	2.5
Cumulative number of deaths due to HIV/AIDS	13.9

Data from UNAIDS (1998).

30% of new infections, even in developed countries, affect women. In parts of the developing world HIV infection has been catastrophic. By the end of 1998, estimates of the global burden of HIV infection were close to 50 million cases, with 35 million living with HIV and over 14 million deaths since 1981 (UNAIDS, 1998), with more than 5.5 million new infections with the previous year (Table 25.3 and Figure 25.4).

The greatest burden falls on Africa (Figure 25.4), although there has been rapid spread of HIV in India, South-East Asia, South America and Russia. Indeed, India has become the country with the largest estimated number of infected individuals. While HIV-1 infection first arose in Central Africa, the greatest recent increase is in southern Africa, with up to 25–30% young adults infected in South Africa, Botswana and Zimbabwe.

In the world as a whole, approximately 80% of new HIV infection among adults is heterosexually transmitted, the remainder being homosexual (6%), intravenous drug use (7%), and other modes including contaminated blood transfusions and contaminated hypodermic needles (7%). In the UK, 50% of HIV infection is homosexual, the remainder being divided equally between heterosexual and intravenous drug use. Up to 10% of all HIV infection occurs in children, almost entirely among infants of infected mothers. Transmission is mainly perinatal, and maternal antiviral therapy shortly before birth greatly reduces transmission rates. Breast-feeding is also a known route of HIV transmission, particularly during primary infection with high viraemia in the mother.

Different HIV-1 clades or subtypes differ in prevalence geographically. In Africa, subtypes A, C and F are frequent, whereas subtype B is the commonest in the West. In Thailand, subtype E, possibly derived by recombination between African subtypes, is most prevalent. Genetic analysis of HIV-1 sequences which were polymerase chain re-

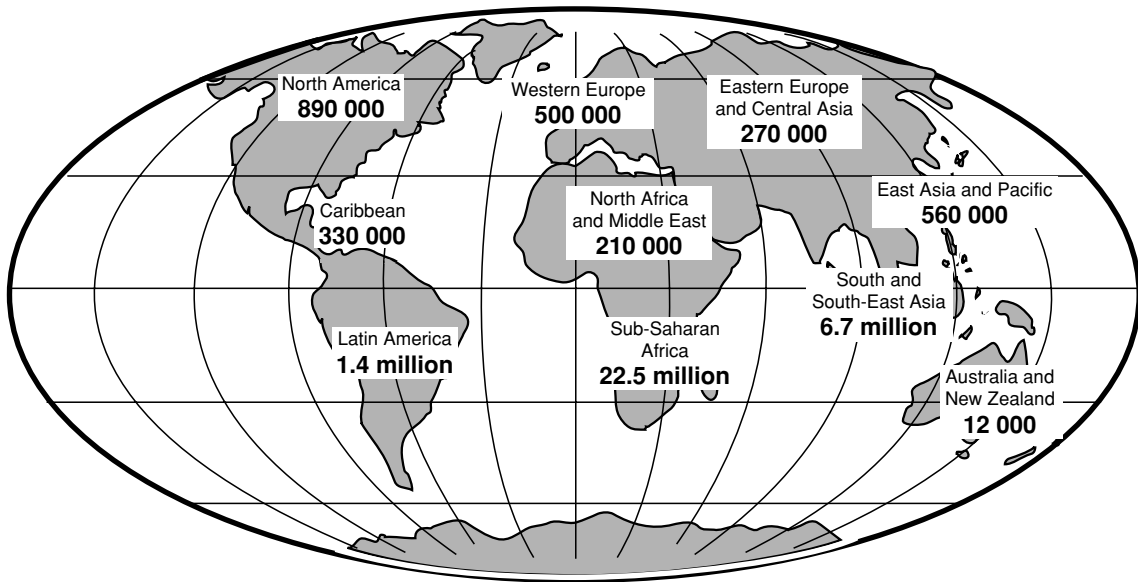

Figure 25.4 UNAIDS world map showing numbers of adults and children (total 33.4 million) estimated to be living with HIV/AIDS at the end of 1998

action (PCR)-amplified and cloned from a Zairian blood sample stored since 1959 (Zhu *et al.*, 1998) indicates that the various subtypes have evolved since that date. Although it was thought that different subtypes might be more favourably transmitted by homosexual, heterosexual and parental routes, by virtue of depending on Langerhans cell infection in the vaginal mucosa versus peripheral blood mononuclear cell (PBMC) infection in the rectum or intravenously, the data have not confirmed this notion (Dittmar *et al.*, 1997).

HIV-2 has had a lower transmission rate than HIV-1. In West Africa, where it remains endemic, HIV-1 infection is now surpassing HIV-2 in incident infections. HIV-2 has spread elsewhere, especially through Portuguese contacts, and it appears to be epidemic in India, although again less prevalent than HIV-1. Mother-to-child transmission of HIV-2 is rare, perhaps owing to a generally lower viral load.

VIROLOGY

HIV Culture and Isolation

HIV can be propagated in short-term cultures of CD4+ PBMCs stimulated by phytohaemag-

glutinin and interleukin 2 (IL-2). The SI strains generally adapt to growth in immortal CD4+ T cell lines, which become chronic virus producers. NSI strains, however, need to be propagated in PBMCs, where they are cytopathic, and in non-cytopathic macrophage culture. Isolation by culture is used to assay infectivity and phenotypic characters, including drug resistance. Figure 25.5 shows HIV particles produced by the CEM cell line in culture.

Isolation of HIV in cell culture can be detected by several means: (1) a cytopathic effect, including syncytia for SI strains; (2) detection of viral antigens in infected cells by antibodies, e.g. immunofluorescence, enzyme-linked immunocytology of infected cells, ELISA for p24 antigen in cells or in supernatant medium from infected cultures; (3) reverse transcriptase assay, either by enzyme activity or by ELISA; and (4) genome detection, using PCR or Southern blots. Virus isolation is useful for determining the phenotype of HIV strains, whether they are SI or NSI, and whether they have developed drug resistance.

HIV Genome and Proteins

Figure 25.6 shows the proviral genomes of HIV-1

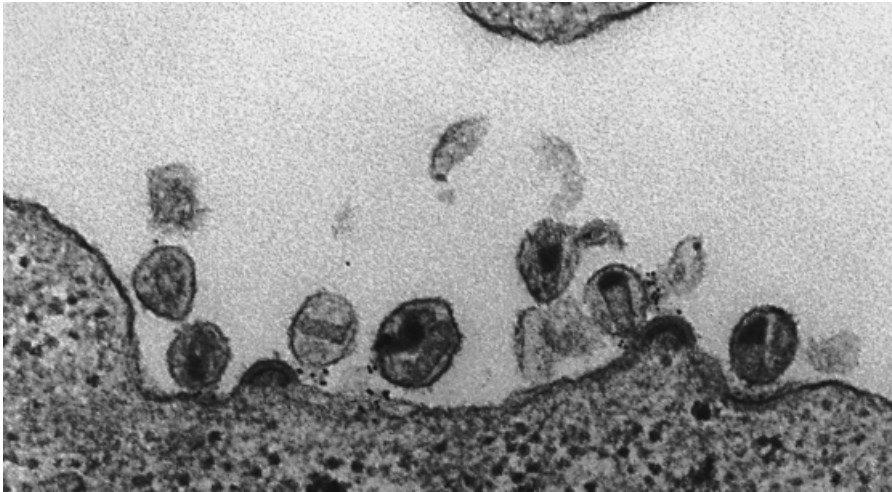

Figure 25.5 HIV-1 particles produced by CEM cells. Note the crescent-shaped core in budding particles and the condensed cone-like core in mature particles of approximately 100 nm diameter. (The black spots are indirect immunogold labelling of antibody from an AIDS patient absorbed to the virus-producing cells)

and HIV-2. The gene maps are similar except that HIV-2 lacks *vpu* but carries *vpx*.

The core and matrix proteins are encoded by *gag*. The *gag* proteins of the mature virus are p17, p24, p7 and p6, and are processed by cleavage of the p55 precursor protein by the viral protease. The matrix antigen p17 is localized to the inner layer of the viral envelope and requires myristilation, which allows it to be tightly bonded to the inner envelope; matrix antigen is indispensable for budding. The core shell is made of p24 capsid antigen. This is the viral protein most usually detected clinically as a measure of antigenaemia. The *pol* gene encodes the

enzymes protease, reverse transcriptase and integrase. The *env* gene encodes the gp41 and gp120 envelope glycoproteins, cleaved by cellular enzymes from the gp160 precursor.

In addition to *gag*, *pol* and *env*, HIV-1 and HIV-2 carry seven regulatory and accessory genes (Emerman and Malim, 1998). The *tat* gene encodes a protein that binds to TAR RNA sequences in the 5' long terminal repeat to upregulate viral RNA transcription through complexes of cellular transcription factors and cyclin T. *Rev* serves to aid export of long HIV transcripts from nucleus to cytoplasm through recognition of Rev-response elements

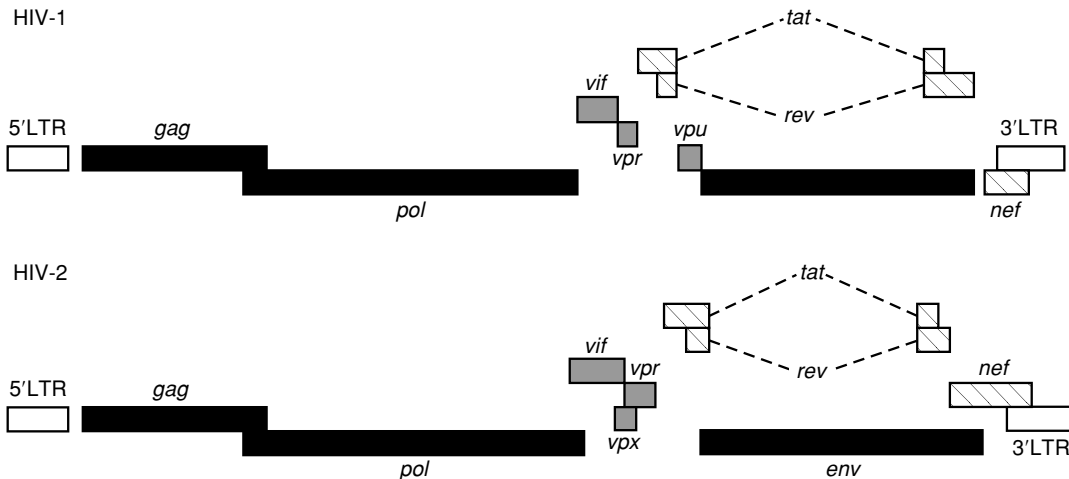

Figure 25.6 HIV-1 and HIV-2 genome maps

(RREs) in unspliced or singly-spliced viral mRNA. *Nef* has multiple functions in signal transduction and downmodulation of CD4 cell surface expression. *Vpr* allows transport of newly infected preintegration complexes of the HIV proviral DNA into the nucleus for integration (by integrase) into host chromosomal DNA. *Vpr* also arrests cells in the G₂ phase of the mitotic cycle, enhancing virus production. *Vpu* and *vif* have poorly understood functions. *Vif* may be incorporated into virus particles and helps infection in new target cells. Although SI strains of HIV-1 can be propagated in T cell lines with deletions or non-functional mutations in *nef*, *vpu* or *vif*, such mutations adversely affect HIV replication in PBMCs and macrophages so that attenuated infection or no replication occurs. Thus all the viral genes are required for efficient infection and pathogenesis *in vivo*.

HIV Serology

The major diagnostic method for determining whether a person is infected by HIV is a serological assay for specific anti-HIV antibodies. A number of ELISA assays are commercially available which are sensitive and specific (having extremely low false-negative or false-positive rates), and which are relatively inexpensive. Most of these assays are based on detection of antibodies bound to HIV antigens in ELISA plates and detected with enzyme-linked antiglobulin. The antigen in modern assays is generally a mixture of recombinant viral proteins, including envelope (gp41) and core (p24) antigens, or including synthetic peptides based on immunodominant epitopes. Some ELISA assays have a competitive format; that is, the antibody in the serum sample to be tested needs to displace an enzyme-labelled standard antibody in the test kit to score a positive result. Microparticle agglutination assays are also useful.

For mass screening of sera, as in blood banks, combined tests for HIV-1, HIV-2 and sometimes other viruses are used. Differential HIV-1 and HIV-2 tests can then distinguish between the two types of HIV. Antibodies to the various subtypes of HIV-1 perform in screening assays with different sensitivities, although current commercial assays detect all subtypes of HIV-1 group M and also the outlier group O, prevalent in Cameroon and Gabon.

Group N has only recently been discovered (Gao *et al.*, 1999) and antibodies to it have not been rigorously tested in commercial kits because so few humans, confined so far to West Central Africa, are group N carriers.

Neutralizing antibodies can be measured by reduction of infectious titre of HIV in cell culture assays. Such assays are not useful for screening or diagnosis but may be important in testing HIV candidate vaccines. Immunofluorescence assays are no longer used for diagnostic purposes.

Differential assays for antibodies in sera to specific HIV antigens are generally performed by Western blot on antigens prepared from whole virions, infected cultures or recombinant viral proteins. In the early days of HIV diagnosis, Western blots were considered important as confirmatory to ELISA tests. They still have a place for sera yielding indeterminate results, especially at the beginning of seroconversion during primary infection. However, genome detection is now preferred for such cases.

HIV Load and Resistance

Detection of viraemia is performed by tests for p24 antigen in plasma (antigenaemia) and by detection of viral genomes. The latter has become a routine diagnostic and prognostic tool in monitoring HIV infection.

The detection of viraemia through the measurement of viral genomes is performed by extracting RNA from virions, preparing complementary DNA and PCR amplification of the cDNA product (RT-PCR) (Berry and Tedder, 1999). These processes can be combined and performed with commercial kits. Alternatives to PCR, such as branched DNA (bDNA) and nucleic acid-sequence based amplification (NASBA) systems are also available. Quantification of viral load can be measured by serial dilution of the sample against a known standard, by competitive PCR, or by real-time kinetic methods of detecting amplified product. Because the plasma HIV load is a useful prognostic marker, as discussed later, quantitative assays are increasingly used and are undergoing refinement by manufacturers.

While the sensitivity of HIV genome detection for the major HIV subtypes is well established, detection of HIV-2 viral load, and detection of minor HIV-1 groups such as groups O and N, requires

further development (Berry and Tedder, 1999).

The principal method of determining HIV infection by a molecular technique is the detection of proviral DNA in peripheral blood cells or other tissues. PCR amplification of proviral DNA, like RT-PCR of virions in plasma, is a sensitive technique, providing inhibitors of the amplifying enzymes are not present in the sample (Berry and Tedder, 1999). The great sensitivity of PCR amplification for any diagnostic target means that there is a danger of obtaining false-positive results unless scrupulous care is taken to prevent contamination of the sample. Modern diagnostic kits incorporate high containment for the sample but the specimen must be handled properly from the point of venepuncture or biopsy.

With the increasing use of antiretroviral therapy and the emergence of drug-resistant HIV strains and substrains, diagnostic methods are required to monitor resistance in managing HIV-infected patients and deciding upon optimal therapy. For the current drugs targeting reverse transcriptase and protease, certain mutations which are associated with a high frequency of drug resistance occur in the *pol* gene. These can either be detected phenotypically by testing drug sensitivity of HIV isolates in culture, or, in a much more rapid and less laborious test, by genotypic detection of mutations identified with drug resistance, by PCR or other genomic amplification.

These molecular techniques for detecting HIV, quantifying viral load and typing for drug resistance have become a significant part of patient diagnosis and clinical management. Measurement of proviral DNA is of importance in detecting early HIV infection before seroconversion (although p24 antigenaemia is also convenient). Measurement of plasma viral load and resistance markers are important for antiviral treatment.

PATHOGENESIS OF HIV INFECTION

HIV Dynamics

Primary HIV infection entails symptomatic fever and lymphadenopathy in about 50% of infections. Following seroconversion, there follows an asymptomatic phase of infection lasting 2–15 years (Figure 25.7). Virologically, however, this does not represent latent infection but rather a high turnover of

HIV production (up to 10^{10} infectious particles per day) and of infected lymphocytes (about 10^8 – 10^9 cells per day) with equally active replenishment (Ho *et al.*, 1995, Wei *et al.*, 1995). Thus it is remarkable that the overall CD4 T lymphocyte count does not decline much faster. Generally, a high HIV load in the plasma after seroconversion is predictive of faster progression to AIDS (Mellors *et al.*, 1996; Phillips *et al.*, 1997a). Lymphoid tissue is actively infected by HIV throughout the asymptomatic period (Pantaleo *et al.*, 1993; Haase *et al.*, 1996).

The constant, high production of virus was discovered through measurement of the perturbation of viral dynamics by antiviral drug treatment (Ho *et al.*, 1995; Wei *et al.*, 1995). It helps to explain the extraordinary rate of evolution of HIV, both within one infected individual, and throughout the human population, because the virus undergoes so many replication cycles, and the reverse transcriptase does not recognize or repair mutations. There are, however, reservoirs of stable, integrated provirus in non-proliferating memory T lymphocytes and in macrophages. These can resupply active HIV replication when antiviral therapy ceases. The high turnover of virus lends itself to antiviral therapy, but it also provides opportunities for selection for drug resistance, immune escape and new cell tropisms to evolve.

HIV-infected lymphocytes may be depleted in several ways: (1) by a direct cytopathic effect of HIV, including cell fusion by SI strains; (2) by cytotoxic T lymphocytes recognizing specific HIV antigenic peptides presented on MHC antigens leading to immune destruction; and (3) by apoptosis due to lymphocyte activation and a changed cytokine and chemokine milieu (Gougeon and Debatin, 1999).

Although apoptosis correlates with disease progression, it is largely a late measure of activation of the affected cells. Studies on apoptosis in human fast progressors, non-progressors and chimpanzees revealed the extraordinary association between apoptosis, non-specific activation of the immune system and progression to disease. Indeed, the most important correlates of disease progression after the virus load and CD4 count are the activation markers, and in this regard the soluble tumour necrosis factor (TNF) receptor is as accurate at predicting disease prognosis as the virus load at the time of infection. There are clear but not absolute correlates between the rate of progression to disease and the immunogenetic background of

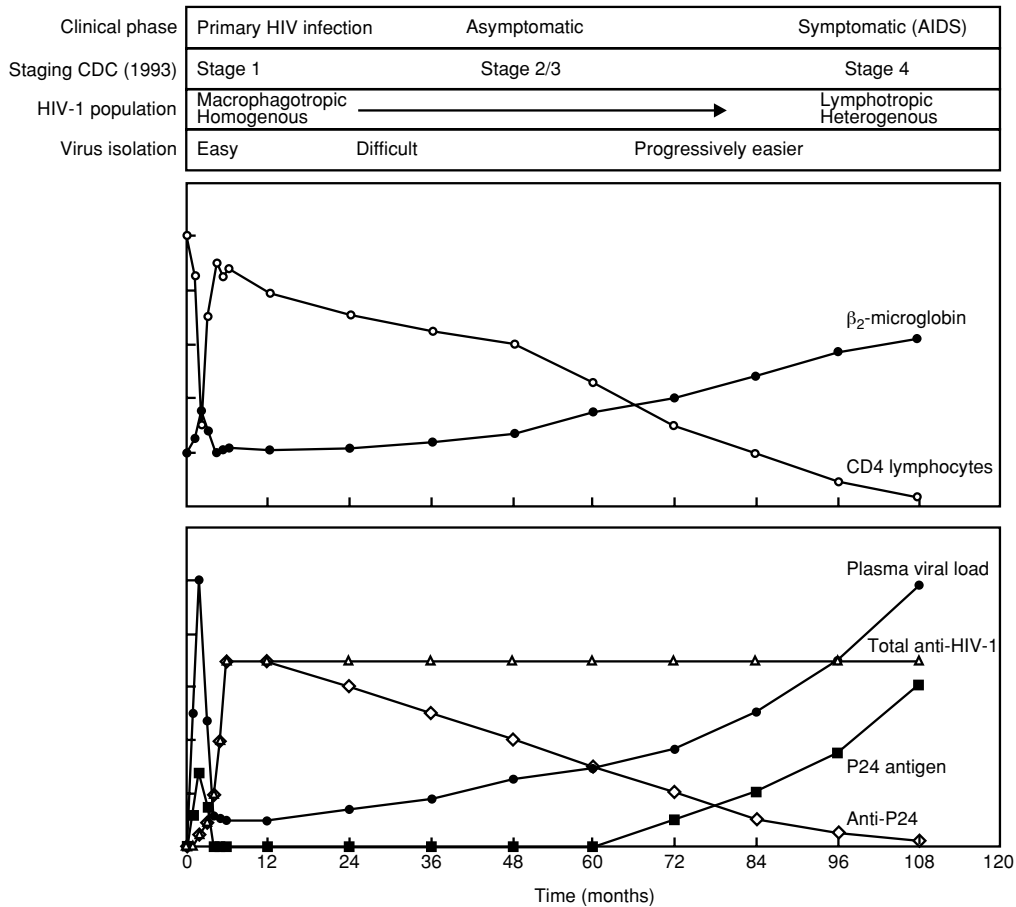

Figure 25.7 The clinical, virological and immunological phases of HIV/AIDS. The clinical phases of the disease have been staged by the Centers for Disease Control (1985, 1993) to define primary HIV infection (PHI, CDC stage 1), asymptomatic (CDC stages 2/3) and symptomatic (CDC stage 4). Viruses are easy to isolate during PHI and are generally a relatively homogenous population of macrophagotropic viruses. During the asymptomatic phase of disease viruses evolve into a heterogenous population but are difficult to isolate; this becomes progressively easier as a population of lymphotropic viruses predominate in the host in symptomatic disease. CD4 lymphocyte counts (○) show distinctive changes during disease, with a rapid, short-term decline associated with the viraemia in PHI, a recovery to near normal levels, a gradual loss of cells during the asymptomatic phase, and finally an accelerated decline associated with late symptomatic disease. The reciprocal of these changes is shown by β_2 -microglobulin (◆), a plasma measure of immune activation. Plasma viral load (●) reaches a peak in PHI (mirrored by P24 antigen, ■), declines to a 'set point' during early asymptomatic disease, and then gradually increases after about 24 months of infection at 0.1 to 0.2 \log_{10} copies ml^{-1} per year. In symptomatic disease viral load and P24 antigen increase progressively. Both viral load and CD4 cell counts in early asymptomatic disease are highly predictive of disease progression. Anti-HIV-1 antibodies (▲) increase to a maximum within 3–6 months of infection and remain detectable throughout the natural course of disease. However, subpopulations of antibodies (i.e. anti-P24 antibodies, ◇) may decline in association with, and predict, disease progression. With the introduction of potent antiretroviral therapy and persistently long-term undetectable plasma virus (< 50 copies ml^{-1}), the antigenic stimulus for the immune system is diminished and quantitative declines in plasma anti-HIV-1 antibodies are observed. This model of the natural history of the disease has been shown in practice to exhibit, in a minority of patients, an accelerated course where viral load remains relatively high or rises, P24 antigen remains detectable, CD4 cell counts decline rapidly and patients progress clinically in < 5 years (rapid progressors), or a protracted course where the CD4 cell counts remain in the normal range and viral load low or undetectable with asymptomatic disease for > 15 years (long-term non-progressors). These differences probably represent the limits of a normal distribution

the host with one of the first observations that patients with HLA-B*08:01 DR3 were exceptionally fast progressors to disease. It is also noted that the same haplotype has a higher activation resting level than many other HLA types. In HIV-1 infected Caucasians, patients with HLA B*27 are slow or non-progressors to disease.

Chronic activation and progression to disease dependent on the HLA background is seen with viruses that encode superantigens. Initial reports that HIV did so have not been confirmed and, although superantigen activity with regards to B cell epitopes have been reported, it is not thought to be sufficient to drive the panactivation seen throughout the immune system in HIV-infected patients progressing to AIDS (Dalglish *et al.*, 1999). This panactivation is also similar to that seen in chronic HLA mismatched transplantation which leads to chronic graft-versus-host disease. This remains a possibility, as HIV incorporates many HLA molecules into its envelope in co-association gp120. This property has been shown to enhance infectivity *in vitro* and could be one mechanism of activating the immune system for the purpose of establishing infection (Westby *et al.*, 1996).

It is thought that this co-association of HLA and gp120 molecules may account for the early reports of complete protection of macaques from simian immunodeficiency virus (SIV) infection after they were immunized with paraformaldehyde-treated human cells infected with SIV. The monkeys were only protected against challenge by SIV propagated in human cells that clearly incorporated HLA molecules, as the correlate of protection was anti-HLA-1 antibodies. Unfortunately, this seems to have been a specific xenogeneic protection and there is no clear evidence as to whether patients who have natural anti-HLA antibodies are protected from HIV, although heavily exposed, seronegative patients tend to have more of these antibodies than a similar non-exposed population.

Incorporation of HLA molecules into the membrane should only provide an allogeneic stimulus, which may be advantageous in order for a low virus load to infect as many cells at the site of entry as possible. This would not explain the ongoing activation, which appears to determine disease progression. As HLA sequences of a length sufficient to mimic an allo peptide are present in the envelope and nef proteins of HIV, it is possible that the presentation of these epitopes is sufficient to keep

the immune system activated even in the presence of highly active antiretroviral therapy.

Cell Tropism and HIV Receptors

HIV infects mainly CD4⁺ cells by binding to CD4 as a receptor (Dalglish *et al.*, 1984). However, many of these cells are not lymphocytes. For example, monocytes, macrophages, dendritic cells (Langerhans cells) and some brain cells, such as the microglia, express the CD4 receptor, and many are infectible with HIV. It is likely that infection of these cell types plays a major role in the pathogenesis of disease. Importantly, HIV can infect some macrophages and dendritic cells without killing them, and hence they may form an important reservoir for persistent infection and be able to infect 'passing' CD4 lymphocytes. Some isolates preferentially infect monocytes compared to T cell lines, and vice versa. The molecular changes that determine this remarkable difference in tropism are small and may affect the envelope, including the V3 loop, as well as nuclear factors if there are changes in the long terminal repeat.

The CD4 cell surface antigen is necessary but not sufficient for HIV-1 infection (Dalglish *et al.*, 1984; Maddon *et al.*, 1986). While CD4 is required for high affinity binding of gp120, coreceptors are required for subsequent steps leading to fusion between the viral envelope and cell membrane. The coreceptors were identified in 1996 to be chemokine receptors and help to explain the differential tropism for lymphocytes and macrophages. Primary, NSI strains of HIV mainly utilize CCR5, which is the receptor for the chemokines MIP-1 α , MIP-1 β and RANTES, whereas SI strains utilize CXCR4, the receptor for stromal derived factor 1 (SDF-1). The discovery that chemokine receptors act as coreceptors to CD4 (Feng *et al.*, 1996; Weiss and Clapham, 1996) helped to explain why certain β -chemokines can inhibit HIV-1 infection *in vitro* (Cocchi *et al.*, 1995). Modified chemokines and small molecular receptor blockers can potentially inhibit HIV-1 entry and may have promise in therapy (Schols *et al.*, 1997; Simmons *et al.*, 1997; Donzella *et al.*, 1998).

The importance of the CCR5 coreceptor for NSI viruses in HIV transmission and disease progression is borne out in people with mutations in

the gene for this receptor. In Caucasian populations a deletion in CCR5, rendering it non-functional, occurs frequently; people homozygous for this 'delta 32' mutation are resistant to NSI HIV-1 infection, even when exposed, for example, by regular sexual contact with an HIV carrier (O'Brien, 1997). A mutation in the promoter region of CCR5, which lowers the level of CCR5 expression, delays progression to AIDS in infected individuals (Kostrikis *et al.*, 1998).

Sequence analysis indicates that HIV in different organs and cell types may represent different subpopulations in the various compartments of the body. Thus the dominant HIV substrains in the blood and cerebrospinal fluid may differ, and within the blood, between CD4 + cells and in CD8 + cells in late stage AIDS (Livingstone *et al.*, 1996). Whereas the depletion of CD4 + cells accounts for the profound immune deficiency, and falling CD4 cell counts are a useful marker of disease progression, the wasting disease and central nervous system (CNS) disease (AIDS dementia) are probably more closely related to macrophage infection. This includes the microglial cells of the brain, which are derived from monocytes rather than neutrophils. Astrocytes may also become latently infected, and changes to local cytokine secretion in the brain lead to neuronal loss.

HIV/AIDS: CLINICAL DISEASE AND MANAGEMENT

HIV/AIDS infection is characterized by an initial acute viral illness followed by a chronic, asymptomatic phase of disease associated with active viral replication and dissemination, and lasting as long as 5–10 years. Ultimately, immune destruction results in end-stage disease (AIDS) associated with opportunistic infections, malignancies and neurological disorders. These clinical events correlate with virological and immunological changes and are shown in Figure 25.7.

Early classification of the disease by the Centers for Disease Control, Atlanta, USA, defined an asymptomatic phase followed by a list of symptomatic conditions that defined AIDS (Table 25.4). This was later revised to reflect the effects of HIV/AIDS infection on clinical status (Table 25.5). Finally, in 1993 it was expanded to take account of

additional respiratory diseases and recently discovered malignancies, and Table 25.6 outlines the classification most widely used to define entry into contemporary clinical trials. The classification of paediatric HIV infection evolved independently to reflect the unique features of the disease in this patient group (Table 25.7).

Early Infection

Primary HIV infection (PHI) results in a well-recognized constellation of clinical, virological and immunological responses associated with rapid and widespread dissemination of virus following infection. An initial illness occurs in 50–90% of cases, is classically described as mononucleosis-like, although in practice < 20% have these features. A typical presentation, in order of frequency, may include: acute onset of fever, lethargy, maculopapular rash, myalgia, headache, sore throat, cervical lymphadenopathy, arthralgia, oral ulcers, photophobia, oral candida, and rarely meningoencephalitis. The time from exposure to onset of signs and symptoms is approximately 10 to 30 days.

Lymphadenopathy is a frequent event during PHI, usually in the second week of illness and is often associated with a lymphocytosis. The lymph nodes tend to decrease in size with time. The architecture remains relatively normal but HIV can be visualized in association with both lymphocytes and dendritic cells.

A distinctive feature of PHI is mucocutaneous disease involving on the buccal mucosa, gingiva, palate, oesophagus, anus and penis.

The commonest neurological feature is an aseptic meningoencephalitis reflecting the neurotropism associated with this group of viruses. Less frequently myelopathy, peripheral neuropathy, bronchial neuritis and facial palsy and Guillain-Barré syndrome are seen. They are usually self-limiting. HIV has been detected in the cerebrospinal fluid (CSF) soon after infection, indicating the speed at which the virus penetrates the blood-brain barrier. Marked changes in the lymphocyte count are seen. The CD4:CD8 ratio is reversed due to an increase in the number of CD8 cells. An early CD4 lymphopenia is characteristic of PHI; it is associated with very high plasma viral load levels that occur in early disease prior to immunomodulation. The

Table 25.4 AIDS defining illnesses in HIV infection (defined in 1985, revised 1993)

Infections	Neoplasms
<i>Pneumocystis carinii</i> pneumonia	Kaposi's sarcoma
<i>Cytomegalovirus</i> (non-RE system)	Primary lymphoma (brain)
Candidiasis (excluding oral)	Non-Hodgkin's lymphoma
Cryptococcosis (extrapulmonary)	Invasive cervical cancer ^a
<i>Mycobacterium avium</i> (disseminated)	
<i>M. kansasii</i> (disseminated)	
<i>M. tuberculosis</i> (disseminated)	
<i>M. tuberculosis</i> (pulmonary) ^a	
Herpes simplex (> 1 month, or non-orogenital)	
Cryptosporidiosis (> 1 month)	
Histoplasmosis (extra pulmonary)	
Toxoplasmosis	
Nocardiosis	
Recurrent disseminated salmonella	
Strongyloidosis (non-intestinal)	
Recurrent bacterial pneumonia ^a	
Coccidioidomycosis (extrapulmonary)	
Isosporosis (> 1 month)	
Primary HIV-1 dementia	
Primary HIV-1 wasting disease	

^aAdded in revisions of 1993.

Table 25.5 Centers for Disease Control (CDC): classification of the effects of HIV-1 infection (CDC, 1985, 1993)

CDC 1	Acute infection with seroconversion (PHI)
CDC2	Asymptomatic infection
CDC3	Persistent generalized lymphadenopathy
CDC4	a Constitutional disease
	b Neurological disease
	c Immunodeficiency
	ci CDC definitions of AIDS
	cii Infections without definition
	d Tumours with CDC definition
	e Others, e.g. carcinomas, interstitial pneumonia

mechanism of this CD4 lymphopenia is explained by a 'predator-prey model; with HIV-1 undergoing multiple rounds of replication and 'consuming' available target cells. It is generally short lived, but on occasions precipitous early lymphopenia does occur and is thought to be one of the aetiological factors associated with acute *Pneumocystis carinii* pneumonia, oral and oesophageal candida and mucocutaneous ulceration. As a rule these early changes normalize with the development of an immune response, CD4 cell counts return to normal range, plasma viral load drops to low levels of detection ('set-point') and p24 antigen becomes undetectable.

The symptomatic phase of PHI lasts about 14 days on average and is self-limiting; however, it is now clearly evident that infection from a host with advanced disease, protracted and wide ranging symptoms, oral/oesophageal candida, neurological involvement, and persistently high plasma viral loads and p24 antigenaemia are associated with rapid disease progression.

The differential diagnosis of PHI should include: Epstein-Barr, cytomegalovirus, herpes simplex, rubella and other acute viral infections; in addition, syphilis, disseminated gonorrhoea, toxoplasmosis and drug reactions should be considered.

Table 25.6 Centers for Disease Control (CDC) AIDS surveillance case definition (CDC, 1993)

CD4 counts ($\times 10^6 l^{-1}$)	Clinical group		
	A: asymptomatic, PGL or PHI	B: symptomatic but not A or C ^b	C: AIDS conditions ^a
> 500	A1	B1	C1
200–500	A2	B2	C2
< 200	A3	B3	C3

PGL = persistent generalised lymphadenopathy; PHI = primary HIV infection.

^a Patients in groups C1, C2, C3, and A3 and B3 are reported as AIDS according to Table 25.4 and/or having a CD4 count below $200 \times 10^6 l^{-1}$.

^b Symptomatic but not included in C are those conditions associated with defective immunity.

Table 25.7 Centers for Disease Control (CDC) clinical categories for children with HIV-1 infection (CDC, 1994)

Category	Clinical stage	Features
N	Asymptomatic	HIV-infected but with no signs or symptoms
A	Mildly symptomatic	Children with two or more of the following conditions but none in B or C: lymphadenopathy hepatomegaly/splenomegaly dermatitis parotitis persistent urinary tract infections
B	Moderately symptomatic	Children with conditions other than those in A or C including: anaemia persistent fever (> 1 month) cytomegalovirus (onset < 1 month of age) herpes simplex stomatitis (recurrent < year) herpes simplex bronchitis/oesophagitis disseminated varicella hepatitis bacterial meningitis, pneumonia or sepsis toxoplasmosis (< 1 month) candidiasis, persistent oral after 6 months age nocardiosis diarrhoea, chronic cardiomyopathy or nephropathy
C	Severely symptomatic	Cytomegalovirus (onset > 1 month) Herpes simplex oral/internal > 1 month Kaposi's sarcoma Candidiasis, oesophageal/pulmonary Coccidioidomycosis (disseminated) Cryptococcosis (extrapulmonary) Cryptosporidiosis (symptoms > 1 month) Histoplasmosis (disseminated) <i>Mycobacterium tuberculosis</i> (disseminated) <i>Mycobacterium avium or kansasii</i> <i>Pneumocystis carinii</i> pneumonia Salmonella septicaemia Toxoplasmosis (CNS, < 1 month age) Recurrent serious bacterial infections Encephalopathy (developmental delays) Progressive multifocal leukoencephalopathy Wasting syndrome (developmental delays)

The Asymptomatic Phase

The period after PHI and prior to symptomatic disease has been described as the latent or asymptomatic phase. Although it is a clinically latent period, in most cases virological latency is misleading, as virus persistence and replication clearly occurs throughout the lymphoreticular and other tissues. A review of factors which affect viral latency and persistence is beyond the scope of this chapter (Levy, 1998; Weiss, 1993).

The duration of the asymptomatic phase may be variable and is related to the severity of PHI, the phenotypic characteristics of the infecting viruses, the status of the host immunity, the life style of the host and the use of antiretroviral therapies (see below).

Clinically, patients are relatively free of symptoms, although lymphadenopathy may be a complaint in some cases. Patients are offered a clinical review every 3 months and regular plasma viral loads and CD4 lymphocyte counts are used to monitor disease status. Plasma viral loads measured 6–12 months after PHI have been shown to be a powerful predictor of subsequent disease progression, superseding CD4 lymphocyte counts taken at the same time, and in combination the two values are an even more accurate method for determination of patient prognosis (Loveday and Hill, 1995; Mellors *et al.*, 1996).

This phase of clinical care is often supportive, involves surveillance of patients for features of early progression and the optimum time to commence antiretroviral therapy.

Symptomatic Disease (AIDS)

In untreated patients early features of symptomatic disease were often non-specific and associated with dermatological manifestations, such as eczema and human papillomavirus eruptions, as well as oral and vaginal candidiasis, recurrent chest infections, night sweats, weight loss and the appearance of lymphadenopathy. Oral lesions become more common with gingivitis, candida, herpes simplex eruptions and aphthous ulcers. 'Oral hairy leukoplakia' presents as white, ribbed lesions on the lateral margins of the tongue; it may be asymptomatic or produce soreness within the mouth. It is associated

with Epstein–Barr virus infection and may respond to acyclovir therapy. All these features are far less frequent in the era of combined antiretroviral therapy.

The progressive immune deficiency associated with long-term HIV/AIDS infection results in opportunistic infections and malignancies which are often multiple and contribute to the rapid clinical deterioration in patients.

Opportunistic Infections

Opportunistic infections seen in symptomatic HIV-1 disease (Tables 25.4 and 25.7) reflect adult and childhood exposure; hence, fungal infections such as histoplasmosis may be seen in persons who come from areas where the organisms are endemic. Infectious organisms may be categorized into: (1) those that do not cause disease in the immunocompetent host (e.g. *Pneumocystis carinii*); (2) Those that cause mild disease in the normal host (e.g. *Herpes simplex virus*, HSV; *Toxoplasma gondii*); (3) Those that are conventional pathogens (e.g. *Mycobacterium tuberculosis*) but, as a consequence of immunosuppression associated with HIV-1 infection, produce widespread debilitating disease in the host.

Overall, the presenting features of symptomatic HIV disease may be very different, according to the geographical areas in which the hosts are found; for example, *Pneumocystis carinii* pneumonia and Kaposi's sarcoma are the commonest presenting diseases in the UK, whereas *Mycobacterium tuberculosis* and gastrointestinal infections are more frequent in Central Africa.

Pneumocystis carinii pneumonia differs from the disease seen in other groups with non-HIV associated immunosuppression, in that it is characterized by subacute onset involving a mild, persistent cough and progressive chest discomfort and fatigue of 2–10 weeks duration. It is rare when CD4 cell counts are above $200 \times 10^6 l^{-1}$. Subtle bilateral infiltrations with a batwing appearance may be seen on a chest radiograph but 50% are normal at presentation. Minimal hypoxia is present and diagnosis is made by detection of the pneumocystis organism in induced sputum or bronchoalveolar lavage. It is treated with co-trimoxazole or pentamidine, and the introduction of prophylaxis in patients with CD4 cell counts $< 200 \times 10^6 l^{-1}$ has markedly re-

duced the incidence of this infection in HIV/AIDS, as have antiretroviral drugs.

Cytomegalovirus (CMV) may also cause a diffuse pneumonitis. It is also the commonest cause of progressive chorioretinitis in AIDS. The lesions are initially asymptomatic but, as the perivascular exudates and haemorrhages involve the macula, vision becomes impaired. Interestingly CMV pneumonitis is rare in AIDS patients because it requires active recruitment of the immune system to cause disease. In contrast, CMV retinitis is common in untreated AIDS patients as it is an uncontained cytopathic disease not requiring immunocompetence. In addition, gastrointestinal ulceration, adrenalitis and encephalitis may occur. Progression of CMV infection can be restricted by parenteral ganciclovir or foscarnet, and the institution of antiretroviral therapies has reduced the incidence and/or severity of CMV.

Cryptococcus neoformans also causes a diffuse pneumonitis, although more commonly it causes meningitis and is widely disseminated. It may also present with fever, granulocytopenia, thrombocytopenic purpura, maculopapular rashes and ulcerating gastrointestinal lesions. It may be isolated from many sites, including throat washings, urine or blood. It is treated with fluconazole or amphotericin B.

Toxoplasma gondii causes space-occupying lesions in the CNS. These patients present with fever and focal neurological signs and may have associated chorioretinitis. Serological tests for toxoplasma are unreliable, and demonstration of the organism in the affected tissues by PCR may offer a more definitive diagnosis. The differential diagnosis of cerebral lymphoma may be excluded using a highly sensitive and specific PCR for *Epstein-Barr virus* (EBV or *Human herpesvirus 4*, HHV-4). It is treated with combinations of antimicrobials.

Other CNS-related conditions include progressive HIV-associated encephalopathy, which involves inflammatory changes in white and grey matter and is characterized by foci of inflammatory cells including macrophages and multinucleate giant cells with actively replicating HIV-1.

Progressive multifocal leucoencephalopathy (PML) is a condition associated with *JC virus* producing oligodendritic lysis. It is diagnosed by characteristic histological changes and confirmed if possible by PCR for *JC virus*. No specific treatment

is available.

In addition viral (including herpes simplex) and bacterial infections are often implicated. Overall the use of combined antiretroviral therapy has had a dramatic impact on the frequency and severity of such conditions.

Mycobacterium avium and *M. intracellulare* are two closely related species of ubiquitous environmental organisms which in the past had rarely been shown to be a cause of disseminated disease. However, it is common in patients with symptomatic HIV infection, suggesting they have an immunological proclivity to these organisms. The organisms are ingested or inhaled and produce disseminated disease with non-specific symptoms, including fatigue, fever, night sweats, weight loss, abdominal pain and diarrhoea, in patients with $< 50 \times 10^6 \text{ l}^{-1}$ CD4 lymphocytes. It is diagnosed by positive blood cultures using Lowenstein-Jensen solid medium (3–4 weeks) or a non-speciating broth medium (1–2 weeks), and confirmation by PCR, in 90% of cases. Treatment and prophylaxis is with specific antituberculous combination therapy. With the advent of highly active retroviral therapy (HAART) these therapies may not be lifelong.

Both this condition and the more classical mycobacteria have become increasingly common in HIV-infected patients in the developed world, and antimicrobial resistant organisms are more evident in this new tuberculosis epidemic.

Oral candidiasis is commonly seen, and oesophageal involvement may be present with dysphagia, odynophagia and retrosternal burning. Diagnosis is based on clinical findings and simple histology. Treatment is by topical antifungal agents or intravenous therapy in the event of refractory and severe disease.

Other fungal infections like *Aspergillus* can produce life-threatening respiratory disease, with white plaque-like colonies in the bronchi, and cavitation. Infection is diagnosed by culture and treated with itraconazole or amphotericin B; the outcome is poor, and time from diagnosis to death is short (months).

Herpes simplex virus (HSV 2 > HSV1) infection commonly presents as a vesicular lesion on an erythematous base in oral, genital or perianal areas. Attacks are usually more widespread and of longer duration, with more frequent recurrences in HIV-1 infection; lesions are associated with secondary bacterial infection and have been associated with wide-

spread epidermal erosion, in some cases requiring skin grafts. Oesophageal and tracheobronchial involvement is described. Diagnosis is by virus culture and/or PCR; treatment is with aggressive use of oral or intravenous acyclovir therapy, depending on the severity of the condition.

Reactivation of *Varicella zoster virus* (VZV, HHV-3) is common in HIV-infected patients but is less often seen in advanced symptomatic disease, probably reflecting the need for the immune response in its pathogenesis. Ophthalmic zoster may be complicated with a threat to vision, and any dermatomal presentation may become disseminated. Treatment is with high dose acyclovir, antibiotics for secondary infection and analgesia.

Human papillomavirus (HPV-6 and -11)-induced warts and molluscum contagiosum (*Poxvirus*) are both common skin conditions in up to 25% of patients with HIV infection and may be of abnormal presentation, and persistent. These manifestations were often used in the past as clinical markers to suggest that further investigation of HIV infection might be indicated.

Persistent or recurrent diarrhoea, which may be copious in volume and watery in content, is a frequent problem in symptomatic patients. *Giardia lamblia*, *Entamoeba histolytica*, *Shigella*, *Salmonella* and *Campylobacter* all cause symptomatic disease; however, appropriate treatment against these pathogens does not always eliminate the watery diarrhoea. *Cryptosporidium parvum*, an enteric coccidium, attaches to the epithelial surface of both small and large intestines and produces protracted and severe diarrhoea in symptomatic HIV/AIDS patients. The diagnosis is by direct modified Ziehl–Neelsen staining of stool preparations; treatment is difficult, with a wide range of antimicrobial agents demonstrating marginal success. CMV, *Mycobacterium avium* and *M. intracellulare*, *Isospora belli*, *Microsporidium encephalozitoozon* and Kaposi's sarcoma involving the bowel wall may also produce these clinical features. There is growing evidence that HIV-1 itself may cause enteropathic signs and symptoms through infection and infiltration of local target cells. In such treatment of specific pathogens is unsuccessful and patients have both malabsorption and loss of weight. The clinical consequences of this condition may be profound; HAART has been found to be of value in some cases.

Kaposi's Sarcoma

Malignancy is a common feature of symptomatic HIV/AIDS as a consequence of the profound cell-mediated immunosuppression, and demonstrates the role of intact immunity in human cancer surveillance. KS is the commonest AIDS-defining malignancy, but non-hodgkin's lymphomas and anogenital squamous carcinomas are of importance (Weiss *et al.*, 1999).

It is striking that tumours present at late asymptomatic or during the symptomatic phase of the HIV disease, at a time of diminishing immunocompetence, and probably represent tumours of a viral aetiology.

KS is a rare vascular or lymphatic tumour (Dupin *et al.*, 1999) that has been simply classified as follows:

- The endemic indolent form seen in elderly Jewish, Greek and Italian men, African children and adults in equatorial Africa, and transplant recipients;
- the aggressive form seen in symptomatic HIV/AIDS patients.

Early studies of the epidemiology of the aggressive form defined clusters of cases in homosexual and bisexual men in the developed world, with increasing cases at sites associated with the original epidemic. Female cases were associated with bisexual male partners. The sexual practice of oroanal contact was significantly higher in those with KS and was proposed as a route of transmission of a potential infectious agent associated with this group. The disease has a lower prevalence in transfusion acquired HIV/AIDS (4%) and haemophiliacs (< 1%), suggesting the blood-borne route as a secondary pathway for transmission.

Using a modified PCR technique applied to subtractive hybridization, Chang *et al.* (1994) analysed normal and KS-associated skin and identified novel DNA sequences in the latter that had high amino acid homology with proteins of EBV or HHV-4 and *Herpes virus saimiri*. A new virus was identified related to the gamma herpesviridae initially called *KS-associated herpesvirus* or *Human herpesvirus 8* (KSHV or HHV-8). DNA from HHV-8 was found in all KS lesions, independent of HIV status (Chapter 2F). PCR and serological assays are available for testing for HHV-8. The presence of HHV-8 predicts

Table 25.8 TIS staging of Kaposi's sarcoma

Criteria	Good risk (0)	Poor risk (1)
Tumour bulk (T)	Limited to skin, lymph nodes or no oral involvement (T0)	Tumour-associated oedema or ulceration; ++ lesions in mouth, GI tract or other organs (T1)
Immune status (I)	CD4 cell counts $> 200 \times 10^6 l^{-1}$ (I0)	CD4 cell counts $< 200 \times 10^6 l^{-1}$ (I1)
Systemic disease (S)	No history of OIs or candidiasis; no B symptoms ^a ; Karnovsky score > 70 (S0)	History of OIs, candidiasis; B symptoms; Karnovsky score < 70 ; other AIDS related illness (S1)

OI = opportunistic infection.

Karnovsky score = clinical scale of HIV/AIDS disability in units of 10, from 0 = dead to 100 = normal, no signs or symptoms.

^a B symptoms—see Table 25.6.

Table 25.9 Choices of treatment of Kaposi's sarcoma

Early disease (T0, I0/1 or S0/1)	Advanced disease (T1, I0/1 or S0/1)
No treatment or Intralesional vinblastine (lesions $< 1 \text{ cm}^2$) or Radiotherapy (lesions $> 1 \text{ cm}^2$) or Interferon α	Radiotherapy or Systemic chemotherapy 1st line: bleomycin + vincristine 2nd line: liposomal anthracycline + doxil

subsequent development of KS. The increasing frequency of HHV-8 seropositivity with age (Sitas *et al.*, 1999) suggests horizontal transmission occurs, and paediatric studies confirm vertical transmission (Boshoff and Weiss, 1998).

Histopathologically a variety of features are seen, which suggests a multipotential mesenchymal cell of origin. Essentially vascular proliferation and spindle-shaped neoplastic cells, which appear to be endothelial in origin, form a network of reticulin fibres. Subclassification on the basis of the amount of vascular malformations and cellular atypia is described. The lesions start in the mid-dermis and extend towards the epidermis. Lesions in the gastrointestinal tract arise in the submucosa.

KS associated with symptomatic HIV/AIDS has a wide variety of clinical presentations. Typically single or multiple indolent lesions appear as pink macular lesions on the skin; they may evolve into

reddish-purple maculopapular lesions or nodules, increasing in size and distribution. They range from benign innocuous lesions to aggressive, invasive and fungating forms over time. Lesions may occlude or invade lymphatics, producing lymphoedema.

A disseminated form occurs, with soft gastrointestinal lesions producing dysphagia or gastrointestinal bleeding. Pulmonary KS is associated with space-occupying bronchial lesions, producing wheeze and cough, dyspnoea, a typical chest X-ray picture, and life-threatening haemoptysis. In both these presentations endoscopy and biopsy require considerable thought. The prognosis of KS is dependent upon the disease stage, the severity of HIV-associated immunosuppression and other systemic illnesses (Table 25.8).

The treatment of KS in HIV/AIDS depends on the severity of the primary disease and the extent of the KS. Broadly, in asymptomatic HIV/AIDS treatment of 'benign' skin lesions is only for psychological or cosmetic reasons, whereas in symptomatic or visceral disease it may be life saving (Table 25.9). Less than 50% respond to systemic chemotherapy and the response time is limited; intralesional vinblastine will reduce bulk and number but leave skin pigmentation. Radiotherapy is used in large skin or oral lesions; responses are good but recurrence common. Immunotherapy using interferon α , even in high doses, only produces a 30% response and is complicated by the systemic toxicity of this agent. In view of the proposed association between HHV8 and KS, experimental studies using cidofovir, gan-

cylovir and foscarnet are proposed for therapy and prophylaxis. The use of HAART for the treatment of HIV/AIDS has reduced the prevalence of KS in patients with symptomatic disease.

Cidofovir and foscarnet inhibit HHV-8 replication, and many find clinical application in controlling the development of KS.

Non-Hodgkin's Lymphoma

Most of the lymphoid malignancies are high-grade Burkitt's lymphomas and immunoblastic lymphomas. The diagnosis is 50 times more common in HIV/AIDS than the normal population. Its age distribution is bimodal, with the former at a peak in 10–20-year-olds and the latter in 50–60-year-olds. Non-Hodgkin's lymphoma is becoming more common in HIV/AIDS as patients live longer as a consequence of prophylaxis for opportunistic infections and HAART. They are usually widespread at presentation and often occur in extranodal sites, particularly the brain. Only about 50% of the lymphomas are EBV related, although higher figures have been claimed in some populations. This suggests that the pathogenesis is more complicated than the expression of an oncogenic virus in the face of immunosuppression, although it is likely that activation of virion stimulation has a role, just as in KS (Weiss *et al.*, 1999).

Diagnosis is essentially by biopsy of systemic non-Hodgkin's lymphoma, but this is not routine for suspected primary cerebral disease. In the latter case a presumptive diagnosis of a CT lesion is made in the absence of response to antitoxoplasmal therapy, a negative thalium uptake scan and a positive EBV PCR result in CSF.

Treatment of systemic disease is stratified according to prognostic factors; generally those with major adverse factors, like prior AIDS-defining illness, CD4 counts $< 100 \times 10^6 l^{-1}$, primary cerebral disease and low Karnovsky score (< 70), receive palliative care and low toxicity chemotherapy, focusing on quality of life. The minority with a better prognosis are treated with conventional 'curative' chemotherapy for non-Hodgkin's lymphoma. Primary cerebral lymphoma is associated with profound immunosuppression and very low CD4 cell counts; a brief clinical improvement is derived from brain radiotherapy and dexamethasone but

the survival time is only about 2 months.

An increased incidence of Hodgkin's disease has been reported in patients with HIV/AIDS. It is associated with intravenous drug users, and is more aggressive in nature than the disease in the general population, with bone marrow or other extranodal involvement. Patients have mixed cellularity or lymphocyte-depleted histology, and a survival time of less than 1 year.

Anogenital Squamous Carcinoma

Rapidly progressive squamous intraepithelial carcinomas develop in the anorectal junction and cervical canals of men and women respectively, with HIV/AIDS. These sites have a squamous-columnar border in common and there may be a viral causation. These regions are commonly infected with *Human papillomavirus* (HPV) in these patient groups, and, especially as immunosuppression increases in symptomatic disease, it is proposed that HPV-encoded oncoproteins (E6 and E7) known to promote genetic instability in cells may lead to tumour formation.

Studies of those with HIV/AIDS confirm an increased risk of *in situ* cervical cancer but not invasive disease (Weiss *et al.*, 1999). Furthermore, once the latter is defined it follows a more aggressive course in this patient group. More frequent (annual) cervical screening is offered to patients with HIV/AIDS but anal cytology in men has not yet been evaluated. These malignancies are treated conventionally with chemotherapy and radiotherapy.

Other tumours that appear to have a high frequency in patients with HIV/AIDS include testicular tumours, squamous cell carcinoma of the oropharynx tumours of the skin, and squamous carcinoma of the conjunctiva in Africa. These may be associated with immunosuppression and/or viral aetiology, e.g. papillomaviruses, but further evidence is awaited.

Clinical HIV/AIDS in Children

Since 1982 cases of vertically transmitted paediatric HIV infection were recognized associated with mothers in traditional risk groups (intravenous drug users, sex workers, partners of haemophiliacs,

transfusion recipients and partners of bisexuals). Further large populations of infected children were identified in sub-Saharan Africa, the seat of the epidemic. Rates of vertical transmission vary between African (30–50%), North America (20–30%) and European (14%) studies. These differences are probably due to populations at different stages of disease being investigated.

Theoretically the virus may be transmitted throughout pregnancy, during delivery and as a consequence of breast-feeding. HIV has been isolated from first/second trimester aborted fetuses; twin studies show the first born has a higher rate of infection, presumed to be associated with longer exposure to secretions; and breast-milk has been demonstrated to carry HIV and be infectious as a consequence of ingestion. Contemporary research evidence suggests the majority of transmission events occur in late pregnancy and during breast-feeding.

Strategies for interruption of vertical transmission have had a dramatic impact on the numbers of children infected with HIV-1 in the developed world. Evidence shows the treatment of the mother with zidovudine during the last trimester of pregnancy and the infant for the first 6 weeks of life produced a 60–70% reduction in vertical transmission (Study ACTG 076: 23% versus 8% transmission; Connor *et al.*, 1994). Studies of combination therapies are now underway to optimize regimens in relation to drug toxicity and duration of treatment. However, these drugs are not available worldwide and probably less than 10% of HIV-infected mothers are in a position to benefit at present. Caesarean section gave early inconclusive results, but a recent meta-analysis of European and American studies showed a 55% reduction in risk of vertical transmission. Avoiding breast-feeding will reduce the rate of transmission and this is advised in the developed world; however, in the developing world the risks to the baby of morbidity and mortality associated with gastrointestinal infections due to lack of conferred immunity from breast milk, and poor hygiene in preparation of bottle feeds, are greater than those associated with HIV infection. Thus at present the World Health Organization advise breast-feeding in the latter and avoidance in the former. Theoretically we have the technologies to almost eradicate vertical transmission of HIV but it requires knowledge of maternal HIV antibody status in early pregnancy accurately to advise

and implement preventative measures and at present this is not universally available. In the developed world the uptake of HIV antibody testing in pregnancy is only about 50%, and in the developing world only an incomplete infrastructure exists to screen patients.

Disease Presentation in Children

Paediatric HIV-1 infection exhibits some distinct qualities in relation to adult disease; the natural history has not been fully defined but infection of the host at a stage of immunological and biofunctional immaturity will clearly influence the expression of disease. Factors like time of infection, exposure to other pathogens, nutritional status, time of diagnosis and quality of care are all important. Evidence suggests two groups of vertically infected infants: 30% with early clinical problems and life-threatening illnesses in the first year of life; and 70% with few problems in early life and developing disease after several years. This has been explained by early transplacental infection in the former and late infection in the latter—a plausible view, but one must also consider issues like pathogenicity of infecting viruses and immunological maturation, which may vary widely from case to case.

CDC disease classification for children is summarized in Table 25.7.

Microbial infections are common in HIV-infected children. *Herpes simplex*, *Varicella zoster* and *Measles viruses* all produce severe forms of the recognized presentations that require prompt and prolonged therapy to avoid high morbidity and mortality. Common paediatric bacterial infections, like *Streptococcus pneumoniae*, *Haemophilus influenzae*, *Escherichia coli* and *Salmonella* species, exhibit unusual presentations and severity; prompt treatment is required until culture results are available, and multiple infections should always be suspected in unresolving cases. Antimicrobial prophylaxis and immunoglobulin are instituted by some centres.

As in adults, opportunistic infections with *Pneumocystis carinii*, *Mycobacterium tuberculosis*, *M. avium* and *M. intracellulare*, CMV, cryptosporidia and non-oral candidiasis as a consequence of immunodeficiency are common.

Failure to thrive is a common feature of paediatric HIV disease. The reasons are multiple: decrease

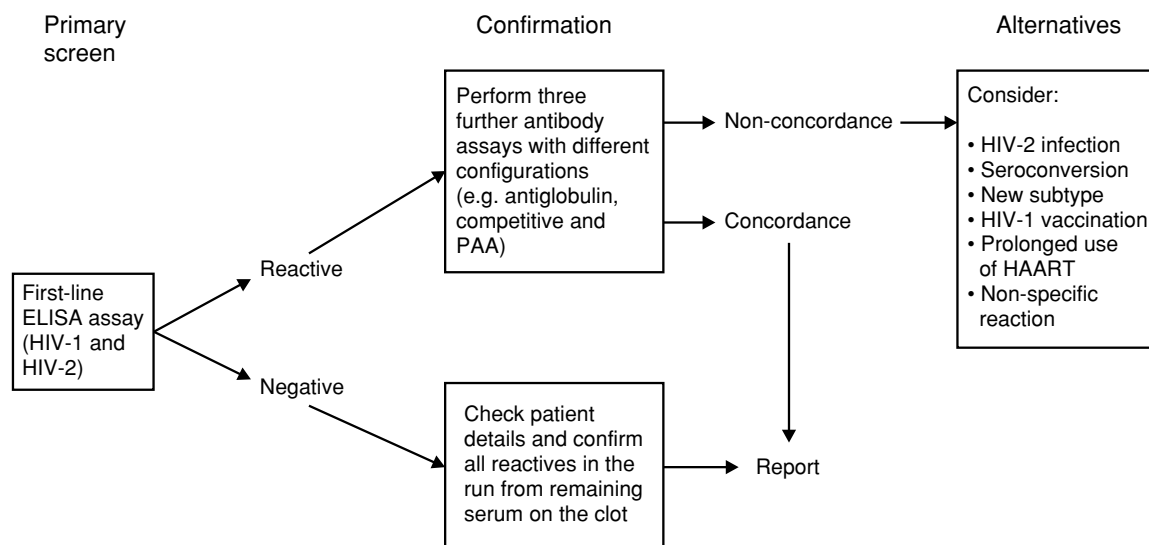

Figure 25.8 An algorithm for the diagnosis of HIV-1 infection.

food intake due to oral infections; decreased absorption due to intestinal disease and recurrent diarrhoea; and decreased calorie utilization for growth due to demands associated with inflammatory responses and tissue repair.

HIV encephalopathy usually occurs in symptomatic disease, presenting with developmental delay, motor deficits, and cognitive and behavioural disorders. It may be slow or rapid in progression, and cerebral atrophy and ventricular enlargement is seen on CT. Other infectious causes like toxoplasma, *JC virus*, mycobacteria and cryptococcus are unusual but should be excluded.

The use of antiretroviral therapies has improved the prognosis for all these clinical conditions, but we do not know the long-term prognosis of acquiring HIV at such an early phase of host development (Pizzo and Wilfert, 1994).

Diagnosis and Monitoring of HIV Infection

Serology remains the cornerstone for the diagnosis of HIV infection in adults. The ELISA assays described earlier in this chapter are based on different biological principles (e.g. antiglobulin, competitive, etc.), have extremely low false-negative rates and are inexpensive. They may be used alone to exclude

adult infection, but a positive diagnosis involves more complex algorithms that are dependent upon the mode of transmission (horizontal or vertical) and the duration of the infection. The availability of antiretroviral therapies makes rapid diagnosis imperative and strategies have therefore been devised to include PCR in the clinical algorithms.

The algorithm for diagnosis of established adult disease is summarized in Figure 25.8. After the primary screen using a sensitive HIV-1 + 2 ELISA assay format, all negative results are reported once the 'reactive' samples in the run (those with a signal greater than the mean of the negative) are confirmed and the patient identification assured. Reactive samples are entered into a confirmatory algorithm using three further ELISA assays with diverse HIV-1 antigens on the solid phase and different principles of action (e.g. antiglobulin, particle agglutination, competitive, etc.). A positive report is released if consensus results are obtained from all three assays (< 90% of cases), and a second blood is requested to confirm patient identity.

If there is non-consensus in the confirmatory tests the clinical virologist should consider HIV-2 infection, seroconversion, non-specific reactivity or rarely a new non-reactive HIV subtype. The proposed algorithm for follow-up of these samples generally resolves 99.9% of cases, but a smaller number remain that often produce alarming reactivity which may persist for life or disappear over time; these

Table 25.10 Typical serological and PCR changes associated with early primary HIV-1 infection

Time (weeks)	- 6	Illness	1	2	4	12
Immunometric	NEG	NEG	NEG	POS	POS	POS
HIV 1 + 2 ELISA	(0.4)	(0.4)	(0.85)	(2.1)	(6.9)	(10.1)
Antiblogulin	NEG	NEG	NEG	NEG	POS	POS
HIV 1 + 2 ELISA	(0.15)	(0.2)	(0.6)	(0.85)	(4.6)	(83)
Competitive	NEG	NEG	NEG	POS	POS	POS
HIV 1 ELISA	(0.4)	(0.4)	(0.9)	(1.1)	(3.7)	(91)
PAA	NEG	NEG	EQUIV	POS	POS	POS
	(< 1/16)	(< 1/16)	(1/16)	(1/32)	(1/128)	(1/512)
Western blot	NEG	NEG	NEG	EQUIV	EQUIV	POS
	(-)	(-)	(-)	(p24 wk b.d.)	(p24/gp 160)	
P24 antigen	NEG	NEG	POS	POS	NEG	NEG
ELISA	(< 10 pg)	(< 10 pg)	(56 pg)	(10 pg)	(< 10 pg)	(< 10 pg)
Diagnostic PCR	NEG	POS	POS	POS	POS	POS
(pol/gag)	(-/-)	(+/+)	(+/+)	(+/+)	(+/+)	(+/+)

cases are often resolved by repeat negative results with diagnostic PCR of proviral HIV-1 DNA from PBMCs.

The Western blot assay is relatively insensitive in relation to modern ELISA assays and is reserved for difficult cases, HIV-2 confirmation, seroconverters and research.

The adult seroconverter is confounded by initial low or non-detectable levels of anti-HIV-1 antibodies, and ELISA assays may be negative in the face of clinical signs and symptoms of PHI. If a clinical diagnosis of PHI is proposed, the sample is tested with all four serological assays, a P24 antigen assay and the diagnostic PCR test. In most cases a PCR positive result is seen prior to, or associated with, low level seroreactivity, and in approximately 50% of cases will show detectable plasma P24 antigen. This is repeated at weekly intervals and evolving signals in the serological assays confirm seroconversion. The Western blot will demonstrate the evolution of a serological response to specific HIV antigens but that post-dates the sensitive serological assays (Table 25.10).

Patients with non-specific reactivity (presumed to have cross-reacting antibodies that signal in certain or all assays) show a distinctive virological pattern but present a difficult clinical problem. They often present through the blood transfusion service as a reactive sample on whom the donation has been withheld. The clinical follow-up usually involves establishing they are PCR negative and that they have non-evolving serology. They are followed over time for reassurance, support if they proceed to any other medical investigations, repeat

testing at 6-monthly intervals, and in the majority the reactivity will eventually wane.

The diagnosis of HIV-1 infection in the newborn infant is confounded by the presence of maternal antibodies in the baby's circulation from approximately 32 weeks of gestation onwards. Early diagnosis is essential for early clinical interventions and considerable effort has been applied to establishing algorithms. One approach uses Western blot and titrated particle agglutination assays to measure qualitatively and quantitatively antibody concentrations from 3 days of life onwards, serum P24 antigen and diagnostic PCR of infant-specific HIV-1 proviral DNA (Table 25.11). If available, PBMC culture may also be added to the algorithm. Rapid diagnosis is confirmed by two positive PCR and one positive p24 antigen result in samples taken at 3 days, 3 weeks and 3 months. Titrated serology in an uninfected baby should demonstrate a halving of passive antibody concentration every 28 days; if antigen (virus) is present and evolving in an infected baby this will reflect in a levelling off of the exponential decline in antibody concentrations or an increase over time. It takes up to 18 months for all passive antibody to resolve in the majority of infants and the analysis and reporting of these events involves considerable virology experience.

Diagnostic strategies are now well-defined but the clinical decision to carry out the test(s) is less straightforward. Indeed the diagnosis of any chronic, incurable and ultimately fatal disease requires evaluation of the benefits for the patient and the implications for others closely associated with that individual.

Table 25.11a Typical serological and PCR changes from birth associated with an uninfected baby

Time	3 days	3 weeks	3 months	6 months	12 months	18 months
PAA	POS (1/600K)	POS (1/400K)	POS (1/48K)	POS (1/6K)	POS (1/200)	NEG (< 1/16)
Western blot	POS (19 bands)	POS (19 bands)	POS (14 bands)	POS (5 bands)	EQUIV (2 bands)	NEG (-)
P24 antigen	NEG	NEG	NEG	NEG	NEG	NEG
ELISA	(< 10 pg)	(< 10 pg)	(< 10 pg)	(< 10 pg)	(< 10 pg)	(< 10 pg)
Diagnostic PCR (pol/gag)	EQUIV (+ / -)	NEG (- / -)	NEG (- / -)	NEG (- / -)	NEG (- / -)	NEG (- / -)

Table 25.11b Typical serological and PCR changes from birth associated with an infected baby

Time	3 days	3 weeks	3 months	6 months	12 months	18 months
PAA	POS (1/900K)	POS (1/600K)	POS (1/90K)	POS (1/70K)	POS (1/200K)	NEG (1/980K)
Western blot	POS (19 bands)	POS (19 bands)	POS (11 bands)	POS (6 bands)	POS (3 bands)	POS (14 bands)
P24 antigen	NEG	NEG	NEG	POS	NEG	NEG
ELISA	(< 10 pg)	(< 10 pg)	(< 10 pg)	(100 pg)	(< 10 pg)	(< 10 pg)
Diagnostic PCR (pol/gag)	NEG (- / -)	POS (+ / +)	POS (+ / +)	POS (+ / +)	POS (+ / +)	POS (+ / +)

In the late 1980s molecular virologists modified PCR-based technologies to quantify HIV-1 RNA load (viral load) and genotypic resistance in plasma viruses (Kaye *et al.*, 1992; Semple *et al.*, 1993), and from 1990 this group and others used these approaches to monitor the efficacy of antiretroviral therapy in trials (Schuurman *et al.*, 1995; Katlama *et al.*, 1996) to demonstrate their predictive value for disease progression (Loveday and Hill, 1995), to demonstrate the association between failing virological response and evolving resistance *in vivo* (Loveday *et al.*, 1995) and to demonstrate the rapid initial decline in plasma HIV-1 (Loveday, 1994) that defined the dynamics of virus replication and allowed the development of new theories of pathogenesis (Coffin, 1995). By 1994 first generation commercial assays were available based upon plasma HIV-1 nucleic acid capture, reverse transcription and amplification and resulting complementary DNA signalling to quantify plasma viral load. These assays initially detected down to a level between hundreds and thousands of copies ml⁻¹ plasma, but later second-generation assays defined cut-off values around 20–50 copies ml⁻¹. The evolution of these assays is summarized in Loveday (1999). These viral load assays were initially used experimentally to define virological efficacy in clinical trials (Brun-Vezinet *et al.*, 1997), and when a large cohort study

revealed the predictive value of such measures for clinical outcome (Mellors *et al.*, 1996) viral load was established as a marker, substituting for clinical end-points, to define the efficacy of new antiretroviral drug combinations. In clinical practice patients have regular viral load measures to assist in the determination of disease stage, progression, responses to antiretroviral therapies and as evidence of early treatment failure.

Early *in vitro* studies and investigations of patients receiving monotherapies revealed that, as viral load response failed, drug-resistant viruses evolved in the plasma. These were detected using both drug sensitivity culture assays (phenotypic) and HIV genome sequencing strategies that identify base changes known to be associated with changes in drug sensitivity (genotypic). The relative advantages and disadvantages of these approaches are summarized in Table 25.12. The measurement of resistance in clinical practice is not yet universally accepted but the majority of virologists, clinicians and patients feel it will have value in optimizing the first and subsequent combination therapies (Hirsch *et al.*, 1998).

1. Attachment and fusion
2. Uncoating
3. Reverse transcription
4. RNase H degradation
5. DNA synthesis
6. Migration to the nucleus
7. Integration
8. Latency
9. Viral transcription
10. RNA nuclear transport
11. RNA stability
12. Protein synthesis
13. Protein glycosylation
14. Packaging and assembly
15. Release
16. Maturation

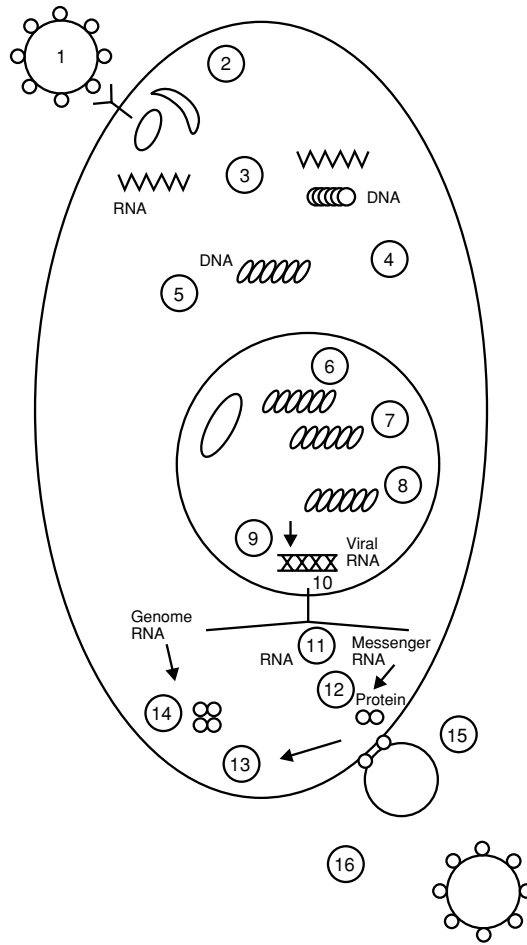

Potential therapeutics

1. T20 peptide, sCD4-Ig proteins, Modified chemokines, DMD 3200, MAbs
2. Hypericin
3. ZDV, ddC, ddI, etc.
4. ZDVMP
- 5-8. None
9. TAR decoy
10. RRE decoys, Rev trans-dominant
11. Ribozymes
12. Antisense molecules, GLQ 223
13. N-butyl, DNJ
14. U-81749, etc.
15. Interferon
16. Protease inhibitors

Figure 25.9 The life cycle of HIV indicating the stages at which potential therapeutics might act

TREATMENT OF HIV-1 INFECTION

The treatment of HIV/AIDS is subdivided into the therapies and prophylaxis for conditions associated with the profound immunosuppression (e.g. *Pneumocystis carinii* pneumonia, KS, etc.) and the anti-retroviral therapy for HIV-1 itself. The former is outlined in the appropriate sections. Since the identification of AIDS in 1981, and HIV-1 in 1983, the rate of development of new antiretroviral drugs to combat this disease has surpassed any other pharmacological developments in modern medical history. In addition, these discoveries have assisted in the understanding of retroviral pathogenesis and

have provided a foundation for the future of clinical management of viral diseases.

History

The potential sites of drug action in the HIV-1 life cycle are summarized in (Figure 25.9). In reality, only the reverse transcriptase and protease activities have so far yielded antiretroviral drugs in routine clinical use.

Historically, the first antiretroviral drug was zidovudine (ZDV or AZT), a nucleoside reverse transcriptase inhibitor (NRTI), identified in 1985

Table 25.12 Comparison of the advantages and disadvantages of genotyping and phenotyping for the determination of antiretroviral drug resistance

	Advantages	Disadvantages
Genotyping	Easily available in laboratories Rapid PCR-based methods (days) Not technically demanding Mutations precede phenotype Quantifies the proportion of wild to mutant strains	Indirect measure Limit of detection (2–5% of population) May not correlate with phenotype Complex data generated that needs virological interpretation May be difficult to interpret Expensive (> £200.00 per sample) If genetically diverse will not amplify Restricted availability (i.e. no clinical throughput system in UK) Slow (weeks) Technically demanding, needs P3 ^a Less sensitive than genotyping Very expensive (> £400.00 per sample) No analysis of sensitivities of combination of drugs
Phenotyping	Direct measure PCR-based technology gives improved variance Familiar to physicians Clear clinical relevance	

^a P3 = high containment laboratory for the culture of certain infectious pathogens like HIV-1.

and shown to exhibit a significant clinical benefit in a placebo-controlled study in patients with symptomatic disease. CD4 lymphocyte counts showed a modest and short-lived increase ($30 \times 10^6 l^{-1}$ over 3–6 months) and introduced CD4 counts as a marker of drug efficacy. High initial doses (1500 mg day⁻¹) were associated with side-effects and toxicity, especially bone marrow toxicity. Nevertheless, use of ZDV was commenced for asymptomatic and symptomatic disease until a larger placebo-controlled study (Concorde Coordinating Committee, 1994) showed early treatment with this drug was no better than deferring therapy until patients were symptomatic. Further nucleoside (ddI, ddC, 3TC, etc.) and non-NRTIs (nevirapine, etc.) were developed but had limited clinical efficacy as monotherapies. Open virological studies in the early 1990s, using quantitative PCR and culture technologies, demonstrated that this was associated with poor virological efficacy and the rapid evolution of drug-resistant viruses in those receiving the monotherapies. Three large monotherapy controlled studies (Delta, ACTG 0175 both with ZDV versus ZDV + ddI or versus ZDV + ddC, and NUCA 3001 with AZT versus AZT + 3TC) between 1992 and 1995 revealed the increased clinical, immunological and/or virological efficacy of two NRTIs over ZDV alone (Delta Coordinating Committee, 1996; Hammer *et al.*, 1996; Katlama *et al.*, 1996).

The introduction of protease inhibitors in 1995 provided a class of drugs with a new site of action that had marked potency alone (not sufficient to be used as monotherapies) and, in combination with two other RT inhibitors (HAART), had exceptional clinical effects and decreased viral load below levels of detectability (< 50 copies ml⁻¹ for more than 12 months (Carpenter *et al.*, 1997). The introduction of these drugs also coincided with virologists examining the early dynamics of viral load changes that allowed the development of models of HIV pathogenesis (Ho, 1995; Wei *et al.*, 1995; Phillips *et al.*, 1997b), and viral load responses to therapy were accepted by drug registration authorities as a preliminary alternative to clinical outcome as a marker of drug efficacy for registration. These events set the targets for modern antiretroviral therapy using multiple drugs that produce a rapid decline in plasma viral load to undetectable, with corresponding increases in CD4 cell counts, with minimal side-effects.

Antiretroviral Drugs

There are currently 14 registered antiretroviral drugs available for combination therapy (Table 25.13) and new NRTIs (dideoxyfluorothiacytidine, FTC; fluorodideoxyadenosine, FddA), nucleotide

Table 25.13 Antiretroviral drugs available to treat HIV-1 infection

Drug	Dose	Viral load ^a and Resistance ^b	Adverse reactions	Comments
<i>NRTIs</i>				
Zidovudine (ZDV)	250–300 mg b.d.	– 0.5 to 0.7 log ₁₀ codons 41, 67, 70, 215 & 219, 151	Nausea, headache myopathy, bone marrow suppression	Prodrug Enters CNS Combivir-AZT/3TC
Didanosine (ddI)	200 mg b.d. 400 mg o.d. (no food)	– 0.5 to 0.7 log ₁₀ codons 65, 74, 75 184, 151.	Nausea, diarrhoea rarely pancreatitis, peripheral neuropathy	Prodrug > Efficacy with hydroxyurea
Zalcitabine (ddC)	0.75 mg t.d.s.	– 0.5 log ₁₀ codons 65, 69 74, 75, 184, 151	Oral ulcers and peripheral neuropathy	Prodrug
Lamivudine (3TC)	150 mg b.d.	– 0.5 to 0.7 log ₁₀ codon 184	Nausea, bone marrow suppression	Prodrug Well tolerated
Stavudine (d4T)	40 mg b.d.	0.6 log ₁₀ codon 75	Peripheral neuropathy	Prodrug
Abacavir (1592)	300 mg b.d.	– 1.5 log ₁₀ codons 65, 74 115, 184	Hypersensitivity: fever, rash, and fatal rechallenge	Prodrug Rechallenge contraindicated
<i>NNRTIs</i>				
Nevirapine	200 mg b.d. initial dose escalation	NR codons 103, 106 108, 181, 188	Rash on induction > 15%, 5% grade 3, Induces cytochrome P450	Long half-life, Induction with prednisolone
Delaviridine	400 mg t.d.s. 600 mg b.d.	NR codons 103, 181 236	Rash > 20%, 5% grade 3, headache, nausea raised LFTs	USA only Inhibits cytochrome P450
Efavirenz	600 mg nocte (minimize side-effects)	NR codons: 100, 103 108, 188, 190	Headache, dizzy, vivid insomnia, rarely psychoses, raised LFTs	Induces and inhibits cytochrome P450
<i>Protease inhibitors</i>				
Indinivir	800 mg t.d.s. fasting/low fat	– 1 to 2 log ₁₀ codons: 82, 46 10 × 2nd MTs	Nausea, nephrolithiasis haematuria, lipodystrophy hyperlipidaemia	'Early efficacy late toxicity' x-resistance PIs
Ritonavir	600 mg b.d. (400 in combo)	– 1 to 2 log ₁₀ codons: 82 & 10 × 2nd MTs	Nausea, vomiting, taste changes, lipid and transaminase elevation	'Early toxicity' x-resistance PIs
Saquinavir (soft gel)	1200 mg t.d.s. (with food) 1800 mg b.d. (with food)	> – 1 log ₁₀ codons: 48, 90 7 × 2nd MTs	Nausea, diarrhoea mild abdominal pain (self-limiting)	Early formulation had poor absorpn x-resistance PIs
Nelfinavir	750 mg t.d.s. (with food) 1250 mg b.d. (with food)	– 1 to 2 log ₁₀ codons: 30 8 × 2nd MTs	Diarrhoea: controlled by drug treatment (self-limiting)	x-resistance PIs
Amprenavir	1200 mg b.d.	> – 1 log ₁₀ codons: 50 4 × 2nd MTs	Nausea, vomiting, taste changes, paraesthesia	x-resistance PIs

LFT = liver function test; MT = mutations; NRTI = nucleoside reverse transcriptase inhibitor; NNRTI = non-NRTI; NR = not recorded; PI = protease inhibitor.

^a Reduction of viral RIVA in plasma.

^b Position of mutations conferring resistance in reverse transcriptase (NRTIs, NNRTIs) and protease.

analogues (phosphonomethylmethoxyethyl adenine, PMEAs; phosphonomethoxypropyl adenine, PMPAs) and protease inhibitors (ABT-378, trimpanavir). Fusion inhibitors and integrase inhibitors are under early trials, as discussed later.

The early work on antiretroviral drugs firstly defined the relatively poor efficacy of monotherapies; secondly, the use of two drugs in combination produced a greater fall and more durable viral load response with added clinical benefit, but

still ultimately failing; thirdly, the addition of a new class of drugs (protease inhibitors) in a triple therapy with NRTIs and/or non-NRTIs (HAART) produced declines in viral load to undetectable (< 50 copies ml^{-1}) and dramatic effects on the clinical features associated with immunosuppression. However, there remains a considerable number of unanswered questions in relation to the future applications to these drugs in combination, and the addition of new drug classes.

The best time to start therapy has not yet been determined. Therapy during PHI has been proposed as an option because at the time of infection the virus population is homogeneous, not widely established and has had minimal impact upon the host immune system. Small trials (30–40 patients) to test the hypothesis of eradication of HIV-1 with HAART where commenced in 1994 (Ho, 1995); to date, approximately 50% are below the level of detectable plasma viral load (< 50 copies ml^{-1}) and the remainder have been discontinued because of drug intolerance or incomplete viral suppression. This important work demonstrates the hypothesis is theoretically feasible in a limited number of patients but is confounded by long-lived HIV-1-infected cell populations and thus does not yet translate into a clinical protocol. Further, it is not clear what the consequences of discontinuing therapy in the early stages of HIV-1 infection are for eventual clinical outcome.

Treatment during early asymptomatic disease is also limited by the durability of response to HAART, owing to evolving resistance, poor adherence and pharmacological issues. Thus, presently decisions to commence therapy with the drugs we have available should take account of the duration of HIV infection; in other words, there should be sufficient combinations available for the duration of the patient's life expectancy. These decisions should also take into account current clinical status, viral load and CD4 cell trends, as well as the patient's opinion, as one is embarking on an extremely exacting therapeutic road that requires a very positive attitude and commitment by patients. Currently, therapies may require that up to 28 tablets per day in divided doses are taken, with and without food, from early morning to midnight, with little scope for missing doses without the risk of viral breakthrough and potentially generation of resistant viruses.

Drug Resistance

The development of resistant viruses has been well understood for a number of years. Essentially, high-frequency, error-prone replication of HIV-1 in the host defines the mechanism by which HIV-1 exhibits darwinian evolution of its reverse transcriptase and protease genes. In a changing drug environment this process results in the evolution of resistant viruses and treatment failure. Genotypic and phenotypic assays have been modified to measure this evolving resistance and many clinicians and clinical virologists feel there is sufficient evidence to introduce these assays into routine clinical care. The evidence is multiple: *in vitro*, HIV-1 grown in the presence of antiretroviral agents will rapidly evolve mutations that are associated with loss of drug sensitivity. *In vivo*, early studies showed that loss of virological suppression with monotherapies was associated with the evolution of genotypic and phenotypic resistance. Retrospective analyses of stored specimens from patients in early clinical trials revealed resistance at baseline, or that evolving during therapy, was significantly associated with virological and clinical failure. Two prospective randomized controlled trials that allocated highly drug-experienced patients to resistance testing or not, provide evidence that supports its use, at least in the short term. The VIRADAPT and CPCRA-046 trials found that patients who had genotypic resistance tests had a significantly greater viral load drop at 6 months (mean difference $-0.7 \log_{10}$ copies ml^{-1}) and 4–8 weeks (mean difference $0.62 \log_{10}$ copies ml^{-1}) after changing therapy than those who did not, respectively. Further studies are underway but in the meantime some countries are already providing funding for routine testing of their patients.

The changes in drug therapy, from double to triple and more, has resulted in a population of patients who have received most available drugs and are infected with viruses that carry mutations associated with resistance to these drugs. Therapeutic strategies are being explored to use new salvage regimens with higher doses and/or more drugs to assist in controlling viral replication. Data on the long-term success of these studies are not yet available.

The use of antiretroviral therapy in HIV-2 infection is in its infancy and to date only a few small

studies involving suboptimal therapy have been reported; clearly, these will expand based on the experience of protocols for HIV-1 infection.

POTENTIAL NEW THERAPIES

The Need for New Therapies

It is now known that the viral load following infection is far higher than previously expected and the rate of virus turnover and cell death of CD4 cells is also much higher. This means that, in the early years of infection, in most cases enough CD4 cells are made to replace those lost by virus killing. HAART is highly effective at reducing the viral load up to 1000-fold, with many patients having undetectable virus in circulating lymphocytes. This is associated with a rising CD4 count and control of opportunistic infection and neoplasia. Over the last 3 years HAART has revolutionized the treatment of AIDS, literally clearing wards and making the majority of HIV treatment centres an outpatient-based service. Unfortunately HAART is likely to become more toxic the longer it is given and there is an urgent need to devise a treatment to prevent rebound of virus load, which occurs in the majority of patients who cease HAART, usually because of toxicity. This rebound is almost certainly associated with a very low level of ongoing virus activation, which can be observed even in patients with extremely low virus loads.

HAART is far too expensive for the areas of the world where most of the 38 million people infected with HIV now live. However, the fact that the immune system can reconstitute itself after the introduction of HAART gives real hope to the possibility of developing simple therapeutic vaccine regimens that will lead to long-term control of the disease not requiring the current expensive medication we use today. There is also a promise that treatment with inexpensive hydroxyurea to reduce nucleotide pools, together with a single antiviral drug such as ddI, may keep viral load down. If combined with therapeutic immunization, this may offer some hope of HIV treatment in developing countries.

New Antiviral Targets

Given the success so far of antiviral therapy tar-

geted to the two viral enzymes, reverse transcriptase and protease, it will be useful to examine each step in the virus replication cycle to see whether it could be inhibited by a potential drug or biological therapy. Several steps have been effectively blocked experimentally in studies of HIV replication in culture. Figure 25.9 illustrates the various steps that can be targeted but which remain at the research level.

Targeting the third essential viral enzyme, integrase, is one promising avenue because the integration of the DNA provirus into host chromosomal DNA is an obligatory step in HIV replication. The regulatory proteins Tat and Rev are also good targets for attempting to reduce viral load, and a number of approaches are being explored, such as antisense RNA and specific ribozymes, and decoy proteins as dominant inhibitors of regulatory function. The accessory proteins, Vif, Vpr, Vpu and Nef may also yield to inhibition. Although the absence of each individually does not completely stop replication *in vitro*, it greatly attenuates HIV replication, particularly in macrophages, which remain a reservoir for HIV in patients on HAART.

Attachment to receptors and entry into the cell has been one of the most intensively studied aspects of HIV infection. Certain sulphated sugars inhibit the initial attachment step and one (dextrin sulphate) is in clinical trial. Blocking attachment may be an approach to developing topical virucides to lessen the risk of HIV transmission during sexual intercourse.

The specific attachment receptor, CD4, is also a promising target. Soluble, recombinant forms of the CD4 protein (sCD4) showed early promise in blocking HIV in culture, but it was found to be much less effective against primary, NSI strains of HIV than against cell-culture adapted SI strains (Daar *et al.*, 1990). The reason for this difference was found to be that, while sCD4 binds to gp120 on HIV particles of both NSI and SI strains, in the latter case it induces the uncoupling of gp120 from its tethering protein, gp41, resulting in irreversible HIV inactivation, whereas in NSI strains it simply acted as a competing molecule to the cell surface receptor (Moore *et al.*, 1990). Because of the findings of Daar *et al.* (1990), pharmaceutical development of sCD4 was not pursued vigorously. However, there is recent renewed interest because certain tetrameric forms of sCD4 – immunoglobulin chimeric proteins show two advantages: they are more

potent against primary, NSI strains of HIV, and they have a long half-life in human plasma.

The next step in HIV replication after attachment, namely fusion with the cell membrane, has become a target for developing inhibitors. A peptide, T20, based on gp41 sequence, is undergoing early trial. Since the discovery that chemokine receptors act as coreceptors for HIV entry (Feng *et al.*, 1996) they have become a therapeutic target. High concentrations of chemokines themselves are correlated with slow progression to AIDS (Cocchi *et al.*, 1995) and will block HIV entry in culture. A chemically modified form of RANTES, a chemokine binding to the CCR5 receptor, potently inhibits HIV infection (Simmons *et al.*, 1997). Since individuals lacking functional CCR5 (the delta 32 homozygotes discussed earlier in the chapter) can live healthily without CCR5, it is thought that inhibitors targeted to this host cell receptor should not be toxic in blocking essential cellular or immune functions, and are therefore suitable for clinical trial.

The major coreceptor for SI strains of virus, CXCR4, can also be blocked, and a small molecular weight inhibitor, AMD3200 (Schols *et al.*, 1997; Donzella *et al.*, 1998) is about to undergo preliminary trial. Although CXCR4 is not the main coreceptor used by NSI strains of HIV that transmit from one person to another, approximately 50% of infected individuals progressing to AIDS have emerging SI, CXCR4-using HIV variants in the later stages of infection. Effective inhibitors of these HIV variants, such as AMD3200 or sCD4, may help to prevent the onset of AIDS. Of potentially greater importance is a recent report of a small-molecule antagonist of CCR5 that blocks infection of the R5, NSI strains of HIV-1 (Baba *et al.*, 1999).

Immunotherapy

A number of therapeutic approaches here have been attempted in order to 'flag' an ailing immune system (Pantaleo, 1997).

Recently the use of fluid phase immunohumoral transmitters such as cytokines have been examined. IL2 has been shown to decrease plasma viral load and increase peripheral CD4 lymphocyte counts when given as pulsed therapy, by the subcutaneous

route. The biological characteristics of these agents are that they act at a cellular level to increase viral production and then consequently deplete infected cells; thus their therapeutic effects are accompanied by an initial viral load increase during the pulse of therapy (with or without a sudden CD4 cell loss) prior to a depletion of infected cells, and thus a reset of resting viral load (lower than baseline) and CD4 count (higher than baseline). Early trials with IL-2 have shown some marked clinical and virological effects, both alone and in combination with HAART, and a large multinational trial with over 4000 patients is currently underway.

Passive immunization has also been tried by a number of investigators, using either anti-HIV plasma or selected high titre anti-HIV V3 loop antibodies and, in the case of children, normal immunoglobulin. Encouraging results have been claimed with all these approaches, although a claimed correlation between high titre anti-V3 loop antibodies and maternal child transmission could not be duplicated by others. Fears of delivering enhancing antibodies have been voiced by some critics, although no evidence exists for this *in vivo* at present.

The immune response to a variety of antigens recovers in patients on HAART, raising the possibility of actively immunizing these patients therapeutically if the correct vaccine were available. However, it may be possible to reduce the low background activation with a non-specific anti-inflammatory agent such as prednisone; its ability to reduce virus load and increase CD4 counts given alone (although it is counterintuitive for a disease which is an acquired immune deficiency) has already been documented. Diseases of chronic activation of the immune system tend to be associated with a greatly reduced cell-mediated immune cytokine profile and this is the case for HIV infection. It is possible that T_H1 modulators, such as *Mycobacterium*-based vaccines, may also be able to achieve this (Rosenberg and Walker, 1998).

'Therapeutic vaccines' have been explored in HIV-infected subjects to see whether they give benefit and as a preliminary to prophylactic immunization. Early studies involved immunizing HIV-infected patients with a variety of viral preparations. Some, such as Salk's envelope gp120-depleted formaldehyde-fixed virions, or British Biotechnology's type 24 therapeutic vaccine, have focused on the gag product (core protein), presumably to

stimulate (cytotoxic T lymphocyte (CTL) responses. This approach has not yet demonstrated any major clinical benefit.

In contrast, the US Army decided that the envelope was the best candidate for a therapeutic vaccine. They settled on a gp160 (MicroGenSys) with poor conformational similarity to gp120, which can be argued *post hoc* like Salk to be potentially advantageous. Early studies suggested a delay in CD4 depletion and improved T-cell proliferation response, with a higher level of antibodies to certain HIV peptides. A number of similar studies have included use of gp120 from several sources. No major breakthrough has occurred in this area to date and critics of this approach worry that the immune stimulation may lead to enhanced viral spread.

PROSPECT FOR HIV VACCINES

If the AIDS pandemic is to be brought under control, a safe, efficacious vaccine that protects individuals from HIV infection will be a crucial component of any public health programme. Unfortunately, despite intensive research effort, no truly effective prophylactic vaccine is in sight. Nevertheless, there are some interesting leads, and, as already discussed, there is some promise of immunotherapy for those already infected with HIV. If therapeutic vaccination were to prove valid, it might indicate useful avenues to explore for preventative vaccines (Rosenberg and Walker, 1998).

Candidate Vaccines

All the approaches to vaccine preparation that have been used to protect against other viruses and microbes have been investigated for HIV at the experimental level. They are listed in Table 25.14. Currently, most research lies in utilizing virus vectors for HIV antigens, such as modified vaccinia Ankara, or avipox virus or poliovirus chimera. These can induce both humoral and cellular immunity. Combined with DNA vaccines as a booster (or as a primary immunogen) some degree of protection looks promising in animal models.

The one really effective approach in protecting monkeys from challenge with a pathogenic SIV

Table 25.14 Possible approaches to HIV vaccines

<i>Immunogens</i>
Whole killed virions
Purified protein subunits
Recombinant proteins
Synthetic peptides
Viral vectors
<i>Vaccinia</i>
<i>Canarypox</i>
<i>Polio</i>
<i>Venezuelian equine encephalitis</i>
DNA encoding HIV antigens
Live attenuated HIV
<i>Adjuvants</i>
Those that induce T _H 1 cellular immune responses

strain is to use a live, attenuated vaccine, such as an SIV with deletion mutations in two or more genes, e.g. *nef*, *vif* and *vpx*. The problem with a live, attenuated HIV vaccine is that it would take decades to show it was indeed attenuated, let alone harmless, in phase I/II human trials. Since the pathogen itself takes a mean time of 9–10 years to cause AIDS, the prospect of defining a safe, yet efficacious, live vaccine remains daunting. It is more likely, therefore, that the lessons learned from live, attenuated vaccines in macaques will need to be applied to induce similar immune parameters in humans without exposure to live HIV.

Successful virus vaccines such as smallpox and polio produce neutralizing antibodies which are associated with protection from infection. With the emerging epidemic of HIV, it quickly became apparent that this simple approach was unlikely to succeed because, firstly, the neutralizing antibody response to HIV-1 is slow to appear and mature compared to other viruses, and, secondly, there is much antigenic variation. Moreover, immune responses may be weak during the entire course of the infection and the extensive ability of the viral envelope glycoproteins to mutate leads to escape from neutralizing epitopes. Although envelope-based immunogens have been able to protect chimpanzees and macaques from challenge by the same virus strain, this has not always correlated with the detection of neutralizing antibodies. Vaccinees in phase I and II studies in humans produced poorly or non-neutralizing antibodies against primary isolates. In those vaccinees who have become infected with HIV in spite of being vaccinated against gp120 or gp160, there appears to be no modulation by the vaccine on disease progression.

Nevertheless, passive transfer experiments with a tetrameric form of soluble CD4 will protect against HIV-1 infection by primary, NSI isolates in a human PBMC/SCID mouse model, suggesting that neutralizing antibodies could also protect, in theory, against infection. In order to obtain a better understanding of the epitopes required for an effective vaccine, an extraordinary amount of work has gone into understanding the structures and interactions of the outer envelope glycoprotein, gp120, and the membrane-bound gp41, as well as the CD4 and the chemokine receptors used by HIV. It is thought likely that the gp120 has different conformational structures, with the variable V1/V2/V3 loops being dominant and covering conserved binding sites for CD4 and the coreceptors. These conserved antigenic sites are only exposed during virus fusion with the cell membrane, although cell-passaged, SI strains of HIV allow exposure. In addition, primary HIV isolates expressing oligomeric envelope antigens have different neutralizing epitopes than monomeric gp120 or gp160, which may explain the observation that antibodies raised against the monomeric form are not effective against primary isolates. Recombinant antigen based on gp120 or gp160 with deletion of variable loops may elicit broader protective humoral and cellular immune responses.

The main function of a neutralizing antibody would appear to be the inhibition of attachment or interaction between the virus envelope and its cellular receptor, either to CD4 or the chemokine coreceptor. Although novel strategies using oligomeric-based vaccines with variable regions deleted and reduced glycosylation may be effective, a major limitation with the antibody approach alone is the fact that when it is induced it is relatively short-lived, being only 40–60 days.

Cell-Mediated Immunity

The failure to induce clear protection with neutralizing antibodies has led to the exploration of other immune modalities, such as the cell-mediated immune response. Cytotoxic T lymphocytes (CTLs) specific for HIV can be detected without any prior culture in cells *ex vivo* without stimulation, which is unusual in virus infection (Ogg *et al.*, 1998). This suggests that there is an unusually high precursor

frequency of CTLs during HIV infection. Stimulation of CTLs allows the identification of specific CTL epitopes. Many HIV peptide epitopes have now been identified with their specific HLA restrictions. They are present on Gag, gp120, gp41, reverse transcriptase and Nef. Unlike neutralizing antibodies, there is a rapid rise in HIV-specific CTL precursors, which coincides with a fall in viraemia in primary infection of many patients. However, other studies have shown that long-term non-progressors have no detectable CTL precursors specific for Gag, envelope and Nef, from which it may be inferred that CTLs are not always necessary, at least for the long-term control of viral infection. Nevertheless, HIV-specific CTLs have been found in exposed but uninfected individuals, such as commercial sex workers in Africa.

Candidate vaccines based on presenting CTL epitopes are now under test. It is not clear if the recombinant viruses or DNA vaccines will be able to induce strong enough response for long-term protection. The most effective protection documented to date in the SIV macaque model is an attenuated live virus which induces strong CTL activity in protection from wild-type virus challenge. If CTLs are important in protecting against HIV infection, the vaccine will need to include conserved epitopes across the HIV subtypes, and which need to be presented by the multiple HLA types and genetic background of the population.

Animal Models and Human Trials

The absence of a clear-cut correlation between infection and neutralizing antibodies, or CTLs has led to a detailed search for correlates of infection, which are complicated by the variability of the research settings in both primates and humans. A major complication has been the failure of most chimpanzees to develop disease following HIV infection, as these rare apes needing protection are the only animals susceptible to HIV infection. However, there is a pathogenic SIV macaque model. Moreover, the SIV envelope can be replaced by the HIV envelope or other genes to form pathogenic chimeric HIV/SIV viruses known as SHIV. A possible limitation is the fact that only one HIV gene can be assessed at a time. Nevertheless, this model has shown that consistently successful vaccination

based on gp120 induces both cell-mediated and humoral responses, with brisk T_H1 followed by T_H2 associated cytokine production. In addition to providing the appropriate antigen, raising a sustained T_H1 immune response is likely to be crucial. Thus, the type of adjuvant employed may be as important as the immunogen for determining longlasting protective immunity.

Clinical studies have commenced at a number of centres despite the failure of therapeutic vaccination with gp160 to alter the course of the disease. Together with the lack of protection in many primate experiments, it led to a cautious approach by the National Institutes of Health and other funding bodies to vaccine development. Pressure groups and patient lobbies have led others to pursue similar approaches into volunteers, even though one randomized study in high-risk uninfected people indicated that vaccinees immunized with gp120 became infected with HIV at a higher rate than the controls. It is not clear whether the vaccine induced enhancing antibodies, making infection upon exposure more likely, or whether the vaccinees, despite careful counselling, indulged in less safe sexual practices. Most vaccines are focused on the envelope of HIV, although one whole killed virus preparation pioneered by Jonas Salk was rendered depleted of gp120, although containing gp41 and the more conserved gag protein. Longitudinal studies suggest a slower rate of disease progression in HIV-positive patients that make a good delayed-type hypersensitivity response, but bias in selection of vaccinees has not been rigorously avoided. Long-term studies are now underway.

CONCLUSIONS AND PROSPECTS

AIDS was first recognized in 1981, HIV-1 was first isolated in 1983 and HIV-2 in 1986. The expanding HIV pandemic of HIV-1 has made AIDS a major infectious disease. In parts of Africa it has swamped clinics and hospitals and the mean expectation of life has been reduced by 20 years. The social and economic impact of AIDS reaches beyond those individuals infected with HIV. Some Asian countries, such as India, may see a similar caseload in the coming decades. Currently, social counselling and health education are the only means of slowing down the spread of HIV; recent surveillance in

Uganda indicates that social policy can be effective, to some extent.

Since the identification of HIV-1, an unprecedented worldwide effort to research and develop effective treatments and vaccines against the virus has ensued. Progress has been marked by both unexpected successes and failures. The cellular and molecular biology of HIV is relatively well understood and the development of the reverse transcriptase and protease inhibitors in current therapies was based on this knowledge. An understanding of viral dynamics *in vivo* has led to hypotheses and models of how the virus may cause disease, and to rational design of drug regimens. Our understanding of precisely how HIV causes AIDS remains enigmatic, where the immune system is part of the pathogenesis as well as the defence against the disease (Weiss, 1993; Levy, 1998).

The rapid heterosexual spread of HIV/AIDS in Africa, Asia and South America has been seen to a much lesser extent in the developed world, but now threatens parts of Russia. In the West, HIV infection remains largely focused in high-risk groups, with secondary cases in low-risk populations. Nevertheless, about 30% of incident cases of HIV infection in the UK now occur among women. That, with the ability to infect the neonate and the persistent and chronic nature of the disease, with horizontal transmission, poses a continuous risk to the population at large. The use of antiretroviral therapies as a prophylaxis is highly effective in preventing vertical transmission but is relatively unproven for horizontal transmission.

The next decade will see the fine tuning of existing combination therapies to establish optimum viral suppression, with minimum pill burden to achieve maximum adherence and thus highly durable responses. In addition, the use of immunotherapies and therapeutic vaccines in combination with traditional and novel antiretroviral drugs may see a direct attack on virus-infected cells. If a new class of drug is developed with the same efficacy as the protease inhibitors one would also predict profound declines in viral load and viral replication, such that existing laboratory technologies might be of little value for monitoring viral load or detection of resistance. One may speculate that the use of more refined assays for quantitative proviral DNA and/or HIV-specific RNA will become more valuable in assessing infection. Current technologies would be reserved for research and salvage therapy

patients. The prospect, however, for total eradication of virus from the host are not good.

A number of pessimistic predictions have been made about the chances of a prophylactic vaccine working. A new generation of preventative vaccines is showing some success in primate models, although this will not easily translate into success in humans. HIV/AIDS burst upon us suddenly about 20 years ago, but it will not disappear. The only realistic long-term approach to the control of this disease is to develop a safe, efficacious vaccine.

REFERENCES

- Achong, B.G., Mansell, P.W.A., Epstein, M.A. *et al.* (1971) An unusual virus in cultures from a human nasopharyngeal carcinoma. *Journal of the National Cancer Institute*, **46**, 299–307.
- Ali, M., Taylor, G.P., Pitman, R.J. *et al.* (1996) No evidence of antibody to human foamy virus in widespread human populations. *AIDS Research and Human Retroviruses*, **12**, 1473–1483.
- Baba, M., Nishimura, O., Kanzaki, N. *et al.* (1999) A small-molecule, nonpeptide CCR5 antagonist with highly potent and selective anti-HIV-1 activity. *Proceedings of the National Academy of Sciences of the USA*, **96**, 5698–5703.
- Barré-Sinoussi, F., Chermann, J.C., Rey, F. *et al.* (1983) Isolation of a T-lymphotropic retrovirus from a patient at risk for acquired immune deficiency syndrome (AIDS). *Science*, **220**, 868–870.
- Berger, E.A., Doms, R.W., Fenjo, E.M. *et al.* (1998) A new classification for HIV-1. *Nature*, **391**, 240.
- Berry, N. and Tedder, R.S. (1999) HIV-1 and HIV-2 molecular diagnosis. In *HIV and the New Viruses* (eds A.G. Dalgleish and R.A. Weiss), pp 207–222. Academic Press, London.
- Boshoff, C.H. and Weiss, R.A. (1998) Kaposi's sarcoma-associated herpesvirus. *Advances in Cancer Research*, **75**, 57–86.
- Brun-Vezinet, F., Boucher, C., Loveday, C. *et al.* (1997) HIV viral load, phenotype and resistance in a subset of drug-naïve participants from the Delta trial. *Lancet*, **350**, 983–990.
- Carpenter, C.J., Fischl, M.A., Hammer, S.M. *et al.* (1997) Antiretroviral therapy for HIV infection in 1997: updated recommendations of the International AIDS Society. *JAMA*, **277**, 1962–1969.
- Centers for Disease Control (1985) Revision of the case definition of acquired immunodeficiency syndrome for national reporting: United States. *MMWR. Morbidity and Mortality Weekly Report*, **34**, 373–375.
- Centers for Disease Control (1993) Review classification system for HIV infection and expanded case definition for AIDS amongst adolescents and adults. *MMWR. Morbidity and Mortality Weekly Report*, **43**, 1–19.
- Centers for Disease Control (1994) Review classification system for human immunodeficiency virus infection in children less than 13 years of age. *MMWR. Morbidity and Mortality Weekly Report*, **43**, RR-12.
- Chang, Y., Cesarman, E., Pessia, M.S. *et al.* (1994) A new herpes virus detected in Kaposi's sarcoma. *Science*, **266**, 1865–1869.
- Cheingsong-Popov, R., Weiss, R.A., Dalgleish, A.G. *et al.* (1984) Prevalence of antibody to HTLV/LAV in AIDS and AIDS-risk patients in Britain. *Lancet*, **ii**, 477–480.
- Clavel, F., Guetard, D., Brun-Vezinet, F. *et al.* (1986) Isolation of a new human retrovirus from West African patients. *Science*, **223**, 343–346.
- Cocchi, F., DeVico, A.L., Garzino-Demo, A. *et al.* (1995) Identification of RANTES, MIP-1 α and MIP-1 β as the major HIV-suppressive factors produced by CD8⁺ T cells. *Science*, **270**, 1811–1815.
- Coffin, F., Hughes, S.H. and Varmus, H.E. (1997) *Retroviruses*. Cold Spring Harbor Laboratory Press, Cold Spring Harbor NY.
- Coffin, J.M. (1995) HIV population dynamics *in vivo*: implications for genetic variation, pathogenesis and therapy. *Science*, **267**, 483–489.
- Collins, K.L., Chen, B.K., Kalams, S.A. *et al.* (1998) HIV-1 Nef protein protects infected primary cells against killing by cytotoxic T lymphocytes. *Nature*, **391**, 397–401.
- Concorde Coordinating Committee (1994) Concorde MRC/ANRS randomised double-blind controlled trial in immediate and deferred zidovudine in symptom-free HIV infection. *Lancet*, **343**, 871–881.
- Connor, E.M., Sperling, R.S., Gelber, R. *et al.* (1994) Reduction of maternal infant transmission of human immunodeficiency virus type 1 with zidovudine treatment. *New England Journal of Medicine*, **331**, 1173–180.
- Conrad, B., Weissmahr, R.N., Boni, J. *et al.* (1997) A human endogenous retroviral superantigen as candidate autoimmune gene in type I diabetes. *Cell*, **90**, 303–313.
- Daar, E.S., Li, X., Moudgil, T. *et al.* (1990) High concentrations of recombinant soluble CD4 are required to neutralize primary human immunodeficiency virus type 1 isolates. *Proceedings of the National Academy of Sciences of the USA*, **87**, 6574–6578.
- Dalgleish, A.G., Beverley, P.C.L., Clapham, P.R. *et al.* (1984) The CD4 (T4) antigen is essential component of the receptor for the AIDS retrovirus. *Nature*, **213**, 736–767.
- Dalgleish, A.G., Marriott, J.B., Souberbielle, B. *et al.* (1999) The role of HIV gp120 in the disruption of the immune system. *Immunology Letters*, **66**, 81–87.
- Delta Coordinating Committee (1996) Delta: a randomised double blind controlled trial comparing combinations of zidovudine plus didanosine or zalcitabine with zidovudine alone in HIV infected individuals. *Lancet*, **348**, 283–291.
- Dittmar, M.T., Simmons, G., Hibbitts, S. *et al.* (1997) Langerhans cell tropism of human immunodeficiency virus type 1 subtype A through F isolates derived from different transmission groups. *Journal of Virology*, **71**, 8008–8013.
- Donzella, G.A., Schols, D., Lin, S.W. *et al.* (1998) AMD3100, a small molecule inhibitor of HIV-1 entry via the CXCR4 coreceptor. *Nature Medicine*, **4**, 72–77.
- Dupin, N., Fisher, C., Kellam, P. *et al.*, (1999) Distribution of human herpesvirus-8 latently infected cells in Kaposi's sarcoma, multicentric Castlemans disease, and primary effusion lymphoma. *Proceedings of the National Academy of Sciences of the USA*, **96**, 4546–4551.
- Emerman, M. and Malim, M.H. (1998) HIV-1 regulatory/accessory genes: keys to unravelling viral and host cell biology. *Science*, **280**, 1880–1884.
- Feng, Y., Broder, C.C., Kennedy, P.E. *et al.* (1996) HIV-1 entry cofactor: functional cDNA cloning of a seven-transmembrane,

- G protein-coupled receptor. *Science*, **272**, 872–877.
- Gallo, R.C., Salahuddin, S.Z., Popovic, M. *et al.* (1984) Human T-lymphotropic retrovirus, HTLV-III isolated from AIDS patients and donors at risk for AIDS. *Science*, **224**, 500–503.
- Gao, F., Yue, L., White, A.T. *et al.* (1992) Human infection by genetically diverse SIVSM-related HIV-2 in west Africa. *Nature*, **358**, 495–499.
- Gao, F., Bailes, E., Robertson, D.L. *et al.* (1999). Origin of HIV-1 in the chimpanzee, *Pan troglodytes troglodytes*. *Nature*, **397**, 436–441.
- Gottlieb, M.S., Schroff, R., Schander, H.M. *et al.* (1981) *Pneumocystis carinii* pneumonia and mucosal candidiasis in previously healthy homosexual men: evidence for a new acquired cellular immunodeficiency. *New England Journal of Medicine*, **305**, 1421–1424.
- Gougeon, M.L. and Debatin, K.M. (1999) Molecular control of programmed cell death in HIV infection: contribution to the dysregulation of T cell homeostasis and to CD4 depletion. In *HIV and the New Viruses* (eds A.G. Dalgleish and R.A. Weiss), pp 99–114. Academic Press, London.
- Griffiths, D.J., Cooke, S.P., Hervé, C. *et al.* (1999) Detection of human retrovirus 5 in patients with arthritis and systemic lupus erythematosus. *Arthritis and Rheumatism*, **42**, 448–454.
- Haase, A.T., Henry, K., Zupancic, M. *et al.* (1996) Quantitative image analysis of HIV-1 infection in lymphoid tissue. *Science*, **274**, 985–989.
- Hammer, S., Katzenstein, D., Hughes, M. *et al.* (1996) A trial comparing nucleoside monotherapy with combination therapy in HIV-infected adults with CD4 cell counts from 200–500 per cu mm. *New England Journal of Medicine*, **335**, 1081–1090.
- Heneine, W., Switzer, W.M., Sandstrom, P. *et al.* (1998) Identification of a human population infected with simian foamy viruses. *Nature Medicine*, **4**, 403–407.
- Hirsch, M., Conway, B., D'Aquila, R. *et al.* (1998) Antiretroviral drug resistance testing in adults with HIV-1 infection: implications for clinical management. *JAMA*, **279**, 1984–1991.
- Ho, D.D. (1995) Time to hit HIV early and hard. *New England Journal of Medicine*, **333**, 450–451.
- Ho, D.D., Neumann, A.U., Perelson, A.S. *et al.* (1995) Rapid turnover of plasma virions and CD4 lymphocytes in HIV-1 infection. *Nature*, **373**, 123–126.
- Katlama, C., Ingrand, D., Loveday, C. *et al.* (1996) Safety and efficacy of lamivudine (3TC) and zidovudine (ZDV) combination in antiretroviral naive HIV-1 infected patients: a comparison with monotherapy. *JAMA*, **276**, 118–125.
- Kaye, S., Loveday, C. and Tedder, R.S. (1992) A microtitre format point mutation assay: application to the detection of drug resistance in human immunodeficiency virus type 1 infected patients treated with AZT. *Journal of Medical Virology*, **37**, 241–246.
- Kostrikis, L.G., Huang, Y., Moore, J.P. *et al.* (1998) A chemokine receptor CCR2 allele delays HIV-1 disease progression and is associated with a CCR5 promoter mutation. *Nature Medicine*, **4**, 350–353.
- Levy, J.A. (1998) *HIV and the Pathogenesis of AIDS*. American Society of Microbiology Press, Washington DC.
- Levy, J.A., Hoffman, A.D., Kramer, S.M. *et al.* (1984) Isolation of lymphocytotropic retroviruses from San Francisco patients with AIDS. *Science*, **225**, 840–842.
- Livingstone, W.J., Moore, M., Innes, D. *et al.* (1996) Frequent infection of peripheral blood CD8-positive T-lymphocytes with HIV-1. *Lancet*, **348**, 649–654.
- Loveday, C. (1994) An Approach to quantification of serum HIV-1 RNA load by PCR (viral dynamics). Annual Scientific Meeting of the Association of Clinical Pathologists Ect. 20–21st 1994. In *Yearbook* (ed. M.R. Haeney), pp 70–73. Association of Clinical Pathologists, London.
- Loveday, C. (1999) Ultrasensitive assays for nucleic acid quantification. Ed. H. Simmonds. In *Scientific and Clinical Implications of Resistance to Anteretroviral Agents* (ed. H. Simmonds). Mediscript Press. (in press)
- Loveday, C. and Hill, A. (1995) Prediction of progression to AIDS with serum HIV-1 RNA and CD4 counts. *Lancet*, **245**, 790–791.
- Loveday, C., Kaye, S., Tennant Flowers, M. *et al.* (1995) HIV-1 RNA load and mutant genotypes during zidovudine therapy. *Lancet*, **345**, 820–824.
- Löwer, R., Löwer, J. and Kurth, R. (1996) The viruses in all of us: characteristics and biological significance of human endogenous retrovirus sequences. *Proceedings of the National Academy of Sciences of the USA*, **93**, 5177–5184.
- Maddon, P.J., Dalgleish, A.G., McDougal, J.S. *et al.* (1986) The T4 gene encodes the AIDS virus receptor and is expressed in the immune system and the brain. *Cell*, **47**, 333–348.
- Mellors, J.W., Rinaldo, C.R., Gupta, P. *et al.* (1996) Prognosis of HIV-1 infection predicted by the quantity of virus in plasma. *Science*, **272**, 1167–1170.
- Moore, J.P., McKeating, J.A., Weiss, R.A. *et al.* (1990) Dissociation of gp120 from HIV-1 virions induced by soluble CD4. *Science*, **250**, 1139–1142.
- O'Brien, S. (1997) In search of AIDS-resistance genes. *Scientific American*, **277**, 44–51.
- Ogg, G.S., Xia, J., Bonhoeffer, S. *et al.* (1998) Quantitation of HIV-1-specific cytotoxic T lymphocytes and plasma load of viral RNA. *Science*, **279**, 2103–2106.
- Pantaleo, G. (1997) How immune-based interventions can change HIV therapy. *Nature Medicine*, **3**, 483–486.
- Pantaleo, G., Graziosi, C., Demarest, J.F. *et al.* (1993) HIV infection is active and progressive in lymphoid tissue during the clinically latent stage of disease. *Nature*, **362**, 355–358.
- Perron, H., Garson, J.A., Bedin, F. *et al.* (1997) Molecular identification of a novel retrovirus repeatedly isolated from patients with multiple sclerosis. *Proceedings of the National Academy of Sciences of the USA*, **94**, 7583–7588.
- Phillips, A.N., Eron, J.J., Bartlett, J.A. *et al.* (1997a) HIV-1 RNA levels and the development of clinical disease. *AIDS*, **10**, 859–865.
- Phillips, A., McLean, A., Loveday, C. *et al.* (1997b) HIV-1 dynamics after transient antiretroviral therapy: implications for pathogenesis and clinical management. *Journal of Medical Virology*, **53**, 261–265.
- Pizzo, P. and Wilfert, C. (eds) (1994) *Paediatric AIDS*. Williams and Wilkins, Baltimore.
- Rosenberg, E.S. and Walker, B.D. (1998) HIV-1-specific helper T cells: a critical host defense. *AIDS Research and Human Retroviruses*, **14** (suppl. 2), S143–S147.
- Rosenblum, L. and McClure, M.O. (1999) Non-lentiviral primate retroviruses. In *HIV and the New Viruses* (eds A.G. Dalgleish and R.A. Weiss), pp 251–279. Academic Press, London.
- Schols, D., Este, J.A., Henson, G. *et al.* (1997) Bicyclams, a class of potent anti-HIV agents, are targeted at the HIV coreceptor

- fusin/CXCR4. *Antiviral Research*, **35**, 147–156.
- Schuurman, R., Nijhuis, M., Van Leeuwen, I. *et al.* (1995) HIV RNA load and appearance of resistance of resistant virus populations in persons treated with 3TC. *Journal of Infectious Diseases*, **171**, 1411–1419.
- Semple, M.G., Kaye, S., Loveday, C. *et al.* (1993) HIV-1 plasma viraemia quantification: a non-culture measurement needed for therapeutic trials. *Journal of Virological Methods*, **41**, 167–180.
- Serwadda, D., Mugerwa, R.D., Sewankambo, N.K. *et al.* (1985) Slim disease in Uganda and its association with HTLV-III infection. *Lancet*, **ii**, 849–852.
- Simmons, G., Clapham, P.R., Picard, L. *et al.* (1997) Potent inhibition of HIV-1 infectivity in macrophages and lymphocytes by a novel CCR5 antagonist. *Science*, **276**, 276–279.
- Sitas, F., Carrara, H., Beral, V., *et al.* (1999) Antibodies against human herpesvirus-8 in black South African patients with cancer. *New England Journal of Medicine* **340**, 1863–1871.
- UNAIDS (1998) <http://www.unaids.org/unaids/graphics>. [For information on the AIDS epidemic worldwide.]
- Venables, P., Brookes, S.M., Griffiths, D. *et al.* (1995) Abundance of an endogenous retroviral envelope protein in placental trophoblasts suggests a biological function. *Virology*, **211**, 589–592.
- Wei, X., Ghosh, S.K., Taylor, M.E. *et al.* (1995) Viral dynamics in human immunodeficiency type 1 infection. *Nature*, **373**, 117–122.
- Weiss, R.A. (1993) How does HIV cause AIDS? *Science*, **260**, 1273–1279.
- Weiss, R.A. (1998) Xenotransplantation. *BMJ*, **317**, 931–934.
- Weiss, R.A. and Clapham, P.R. (1996) Hot fusion of HIV. *Nature*, **381**, 647–648.
- Weiss, R.A., Beral, V. and Newton, R. (1999) *Infections and Human Cancer*. Cold Spring Harbor Laboratory Press, Cold Spring Harbor, NY.
- Westby, M., Manca, F. and Dalgleish, A.G. (1996) The role of host immune responses in determining the outcome of HIV infection. *Immunology Today*, **17**, 120–126.
- Zhu, T., Korber, B.T., Nahmias, A.J. *et al.* (1998) An African HIV-1 sequence from 1959 and implications for the origin of the epidemic. *Nature*, **391**, 594–597.

Human T-Cell Lymphotropic Viruses

Graham P. Taylor

Imperial College School of Medicine, London, UK

INTRODUCTION

The HTLV-BLV viruses are a subfamily of retroviruses. They comprise *Human T-cell lymphotropic virus type I* and *type II* (HTLV-I, HTLV-II), *Bovine leukaemia virus* (BLV), and an increasing number of simian or primate T-cell lymphotropic viruses (STLV/PTLVs) closely related to HTLV-I and -II. In a small proportion of cattle infected naturally, BLV is associated with a B-cell leukaemia. However, leukaemia is very common in sheep infected experimentally with BLV. HTLV-I is associated with malignant and inflammatory diseases in humans with evidence of mild immunosuppression. HTLV-II has recently been associated with myelopathy and an increased risk of infections, particularly of the respiratory tract, though its disease associations are less well established than those of HTLV-I. STLVs have been associated with malignant disease in non-human primates, but not necessarily in the primary host species.

THE VIRUS

The discovery of HTLV-I as an important human pathogen was the result of two distinct lines of research. One, the search for cancer-causing retroviruses, culminating in the discovery of the virus in 1980 by Gallo and colleagues in the USA (Poiesz *et*

al., 1980), was the result of years of research and was dependent on the earlier discovery and refinement of tests for reverse transcriptase, together with the identification and use in tissue culture of T cell growth factor, now known as interleukin 2 (IL-2). The second line of research was the recognition (1974) and description (1977) of a new disease entity, adult T cell leukaemia/lymphoma (ATLL) by Takatsuki and colleagues, in Japan (Uchiyama *et al.*, 1977). The clustering of this disease, particularly in southwest Japan, suggested an environmental or infectious aetiology. One of the many transformed T cell lines derived from leukaemia/lymphoma patients and cultivated in the laboratory of Gallo was found to contain a retrovirus. This virus, now known as *Human T-cell lymphotropic virus type I*, is also known as *Human T-cell leukaemia/lymphoma virus type I*. The cell line was derived from the lymphocytes of a Black American (Afro-American) patient originally thought to have an aggressive form of cutaneous T cell lymphoma. However, this was subsequently recognized to be cutaneous ATLL. In 1981, Miyoshi and colleagues produced an immortalized T cell line by the coculture of peripheral blood lymphocytes from a Japanese woman with ATLL with cord blood cells from a male umbilical cord (Miyoshi *et al.*, 1981). This cell line (MT-2), which has an XY karyotype, was observed to produce numerous extracellular type C retroviral particles and was positive for adult T cell leukaemia antigen by indirect immunofluorescence

(Hinuma *et al.*, 1981). Using viral antigens from the MT-2 cells they developed a serological test and showed that nearly all ATLL patients and a high proportion of the relatives had antibodies to this virus (Yoshida *et al.*, 1982). Known initially in Japan as *Adult T cell leukaemia virus* (ATLV), sequence analysis showed that ATLV was almost identical with HTLV-I. Serological studies revealed that ATLV/HTLV-I was endemic in southwest Japan, with 15% of the population seropositive, rising to 30% in some villages. In central Japan only 1% of the population were seropositive, with higher rates again in the north. The inhabitants of central Japan are believed to have come from mainland Asia c. 300 BC, displacing the 'older' population to the north and southwest. The distribution of HTLV-I in the population suggests that HTLV-I has been present in Japan since before this migration.

A related virus, HTLV-II was isolated from the cells of a patient with an atypical hairy cell leukaemia (HCL) in 1982 (Kalyanaraman *et al.*, 1982). Hairy cell leukaemias are usually of B cell origin, while the cell line derived in culture had T cell markers which suggests that the HCL was unrelated to the HTLV-II infection. Although a second isolation of HTLV-II from a patient with HCL was made, subsequently extensive investigation has failed to confirm a disease association. HTLV-II shares 60–70% sequence homology with HTLV-I and is detected by HTLV-I lysate or whole virus based assays.

Simian T-lymphotropic viruses have been found in macaques and other Old World monkeys, and STLV-I appears to be related more closely to HTLV-I than to other STLV/PTLVs. HTLV-I/STLV-I strains cluster geographically rather than by host species. A newly identified PTLV has been shown to be a distant relative of HTLV-II, while another recent isolate is not sufficiently similar to either HTLV-I/STLV-I or HTLV-II to be grouped with these families. It has therefore been assigned to a discrete third family, PTLV-L (the L stands for Leuven where the virus was isolated; HTLV-III has already been used as a former name for *Human immunodeficiency virus type I*, HIV-I) (Van Brussel *et al.*, 1998).

Morphologically HTLV-I and -II resemble C-type retroviruses (Figure 25A.1). They can be grown *in vitro* in immortalized lines which are obtained by culturing patients' cells with phytohaemagglutinin

(PHA) and IL-2. *De novo* infection of T cells and cell lines requires cocultivation using irradiated or mitomycin-C treated HTLV producer cell lines. The HTLVs are not readily transmissible in cell-free form and this is reflected in the observation that only whole fresh blood transfusion and not plasma or other cell-free fractions leads to transmission (Okochi *et al.*, 1984). HTLV infection is not found usually in haemophilia patients (who are generally treated only with cell-free plasma derivatives).

Susceptible cell lines can be identified by the formation of syncytia (giant multinucleated cells) upon contact with virus-producing cells. This interaction requires the presence of the HTLV-I envelope and specific cell membrane ligands (receptors). The syncytial assay has proved useful for studying HTLV-I, particularly in the detection of neutralizing antibody and cellular receptors (Clapham *et al.*, 1984). *In vivo* HTLV-I primarily infects CD4 + cells, while HTLV-II infects CD8 + cells. *In vitro* many cell types from a broad range of species, including astrocytes, can be infected. Although the cellular receptor has not been identified, the coding gene has been localized to chromosome 17 and may be a member of the VCAM family. The envelope proteins of HTLV-I and HTLV-II are the target for neutralizing antibodies. Sera from British or American patients and asymptomatic carriers of HTLV-I neutralize equally viruses from other countries including Japan (Clapham *et al.*, 1984); this suggests that there is a single worldwide serotype for HTLV-I.

The 9 kb genome of HTLV-I contains the three major open reading frames (ORFs) *gag*, *pol* and *env* of all retroviruses flanked by two long terminal repeats (LTRs) with an additional regulatory region, pX (Figure 25A.2). The names, product size and functions of the genes of HTLV-I are summarized in Table 25A.1. The HTLV-II genome is very similar except that five ORFs have been identified in pX.

The first major reading frame codes for a *gag* precursor of 429 amino acids that is cleaved into the three *gag* proteins: 19 kDa (matrix protein), 24 kDa (capsid protein) and 15 kDa (nucleocapsid protein). A second major reading frame within the *gag-pol* complex codes for proteinase. This frame slightly overlaps with *gag* and is generated by a frameshift suppression of the *gag* terminator codon. The reverse transcriptase (which uses Mg²⁺ as a divalent cation) and integrase are encoded by a different



Figure 25A.1 Electron micrograph of HTLV-I particles produced by a T cell line transformed *in vitro*. Note the variable size of the particles and the diffuse spherical core

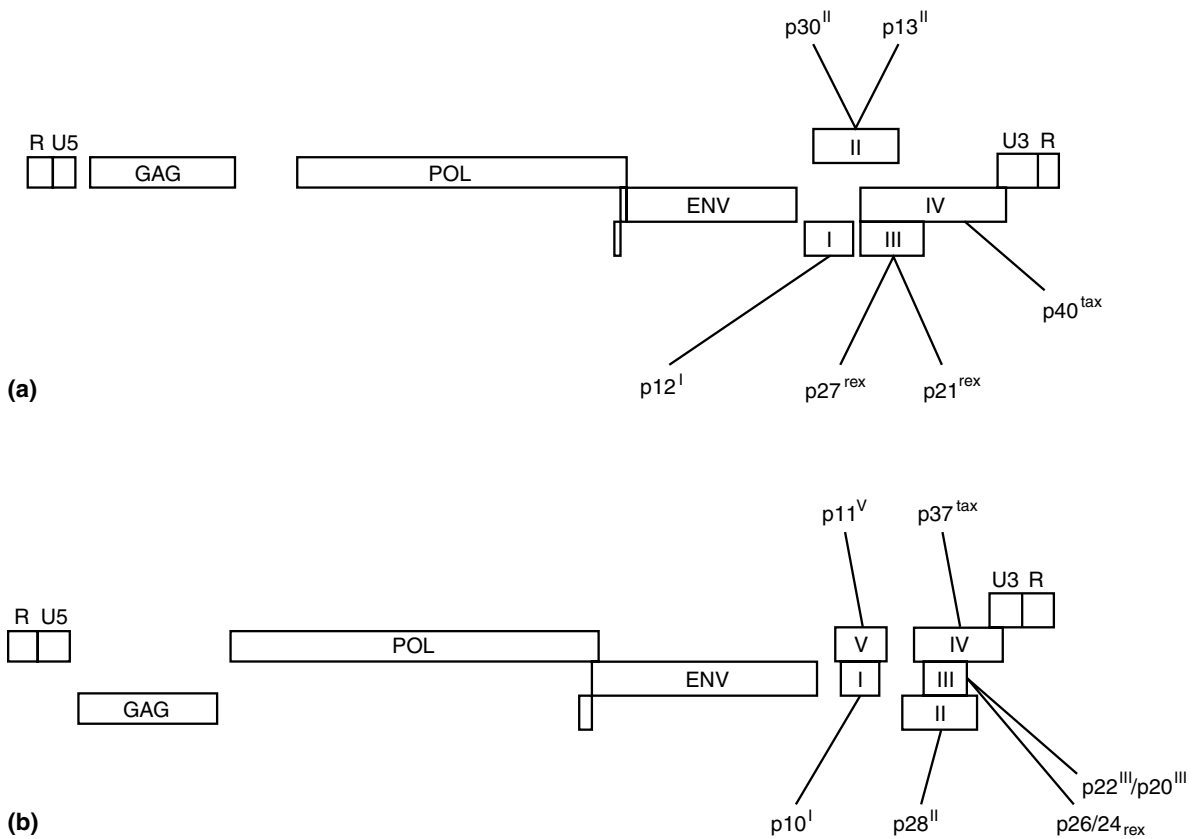

Figure 25A.2 (a) HTLV-I and (b) HTLV-II genomes. (Reproduced with permission from Franchini G (1995) *Blood*, **86**, 3619–3639)

Table 25A.1 Products of HTLV-I genes

5' LTR	Contains regulatory elements essential for viral replication			
<i>gag</i>	Group antigen	nucleocapsid protein	p19	matrix
			p24	capsid
			p15	nucleocapsid
<i>pol</i>	Polymerase	reverse transcriptase	RT	transcription of DNA from RNA
		proteinase		splicing of protein precursors
		RNaseH		synthesis of RNA
		integrase		Integration of proviral DNA into host genome
<i>env</i>	Envelope	Surface glycoprotein	gp46	(SU)
		Transmembrane	gp21	(TM)
<i>pX</i>	ORF I		p12 ^I	
	ORF II		p13 ^{II}	
			p30 ^{II}	
	ORF III		p27	Rex
			p21 ^{rexIII}	Regulatory gene of 'X' region Cytoplasmic protein unknown function
	ORF IV		p40	Tax
3' LTR	Contains regulatory elements essential for viral replication			Transactivating gene of 'X' region

ORF and are cleaved from a 99 kDa precursor protein.

Env codes for a protein of 481 amino acids which, after glycosylation, has a molecular weight of 62 kDa and is processed into an outer surface protein of 46 kDa and a transmembrane protein of 21 kDa. The envelope precursor is translated from a 4.2 kb mRNA in which the *gag* and *pol* have been spliced out.

The fifth genomic region referred to as pX is located between *env* and the 3' LTR. The region codes for *tax* and *rex*, which are translated from a double-spliced 2.1 kb mRNA. In addition there are at least four additional proteins encoded by ORFs I, II and III, although their function is not clear. *Tax* activates transcription from the LTR and is therefore an important upregulator of viral replication. In addition *Tax* transactivates a range of host cellular genes through which it is thought to affect cell replication and play an important role in the pathogenesis of ATLL. The immunodominant peptides for the host cytotoxic T lymphocyte response are also found in the *Tax* protein, which may be important both for the control of infection and in the pathogenesis of inflammatory disease associated with HTLV-I, of which the archetype is HTLV-I-associated myelopathy. The *Rex* protein determines the export of unspliced *gag-pol* mRNA and singly spliced *env* mRNA out of the nucleus, thereby controlling the production of viral proteins and infectious virus. (*Rex* production results in increased export of *env* mRNA and unspliced viral RNA for the *gag/pol* proteins essential for the pro-

duction of new virions and aids a shift from doubly-spliced pX RNA to *gag-pol* and *env* RNA.) Thus the overall effect of *Rex* may be virion production soon after infection, followed by downregulation of viral expression which would protect the infected cell from death due to the cytolytic effect of virion production and protect both the infected cell and the virus from the host immune response (Hidaka *et al.*, 1988). The *Tax* (p37) and *Rex* (p26) proteins of HTLV-II are slightly smaller than those of HTLV-I. *Px* encodes three additional proteins, p10, p28 and p11 from ORFs I, II and V respectively (reviewed in Ciminale *et al.*, 1996).

DIAGNOSIS

Detection of HTLV-I and -II infection is primarily by serology. A particle agglutination assay based on whole viral lysate is sensitive for both viruses but limited by poor specificity. First generation commercial enzyme immunoassays (EIAs) were more specific than the agglutination assays but less sensitive, particularly for HTLV-II. The new generation of EIAs incorporating recombinant peptides are highly sensitive and specific for HTLV-I and HTLV-II. Immunofluorescence assays using fixed infected cells with uninfected cells as controls can be used to confirm and type infections but is 'operator' dependent. Peptide-based assays which discriminate between HTLV-I and HTLV-II are available. HTLV-I infection is usually confirmed by the detec-

tion of gag (p19 and p24) and env (gp21 and gp46) antibodies by Western blot, although radioimmune precipitation assays (RIPAs), radioimmune binding assays (RIBAs), line immunoprecipitation assays (LIAs) and competitive ELISAs can also be used. p19 antibody is often absent in, and not required to confirm, HTLV-II infection. Recombinant env peptides have improved the sensitivity and specificity of Western blots and type-specific antigens rgp46-I and rgp46-II enable the infections to be discriminated without resort to molecular methods. Western blots which reveal some virus-specific bands but which are not sufficient to make a positive diagnosis are termed 'indeterminate'. Further investigation is then warranted, including DNA amplification using generic or type-specific primers. Viral culture may be required to confirm an infection but is costly, time consuming and must be conducted in a category 3 laboratory (HTLV European Research Network, 1996).

VIRAL VARIATION

HTLV-I has a highly conserved genome with only about 4% sequence variation between isolates from around the world. The only exceptions are isolates from Australian aborigines and Melanesians, which form a distinct genotype or clade, HTLV-I_{MEL}, and which have up to 8% diversity in LTR and/or env. Most other isolates from Africa, Japan or the Caribbean belong to the Cosmopolitan clade, HTLV-I_{COS}. Two other clades have been recognized from Central Africa and from Zaire. In phylogenetic analyses HTLV-I, which is almost identical to HTLV-I, clusters with HTLV-I by geography rather than by species (Figure 25A.3). This suggests that there have been a number of simian-human transmissions (Koralnik *et al.*, 1994). HTLV-II shares 60–70% sequence homology with HTLV-I. HTLV-II isolates belong to either genotype a or b but can be further discriminated into subtypes 1–6 by sequencing or restriction enzyme analysis. A number of new primate T-lymphotropic virus isolates fall outside the recognized HTLV/STLV clades (Giri *et al.*, 1994; Goulbau *et al.*, 1994; Liu *et al.*, 1994).

EPIDEMIOLOGY

It has been estimated that 20 million persons worldwide are infected with HTLV-I, including 1.2 million in Japan, where up to 15% of the population in the southwest are seropositive. Other endemic areas are the Caribbean, parts of the southeastern states of USA, Melanesia, parts of sub-Saharan Africa, especially the West and Central Africa (Figure 25A.4a, *see* Plate V). Recently HTLV-I infection has been found to be relatively common in southern Africa, particularly Natal. Up to 0.5% of blood donors in Brazil are HTLV-I seropositive, with considerable interstate variation. HTLV-I infection is recognized among many native South American indigenous peoples as well as among black and Japanese immigrants. However, population mixing has been extensive and in Brazil the proportion of neurology patients with HTLV-I-associated myelopathy/tropical spastic paraparesis (HAM/TSP) is equal among the main racial groups. Northern Iran is another recently described area of HTLV-I infection, with cases described in neighbouring Middle East and central Asian countries. The prevalence of HTLV-I among European Union (EU) blood donors is low (2–7 per 100 000) but remarkably similar across the length and breadth of the EU. Seroprevalence rates 50–100 times higher have been found among women attending antenatal clinics and among men and women attending sexually transmitted disease clinics. However the numbers tested are much smaller and in many countries such studies have not been conducted (Figure 25A.5). In Central and Eastern Europe very few studies have been conducted, but cases of HTLV-I related pathology have been diagnosed in EU member states among patients from Bulgaria, eastern Germany and Romania. ATLL has been described in Georgia and a relatively high rate of HTLV EIA seroreactivity has been reported in Latvian blood donors (reviewed by Taylor, 1996).

HTLV-II infection is found among native American Indians in North, Central and South America and was until recently considered a New World virus (Figure 25A.4b, *see* Plate V). At some time prior to the acquired immune deficiency syndrome (AIDS) epidemic, HTLV-II infection moved into, and has been spread around the developed world by, injecting drug users (IDUs) (Hall *et al.*, 1996). In Europe HTLV-II is common among IDUs in Eire,

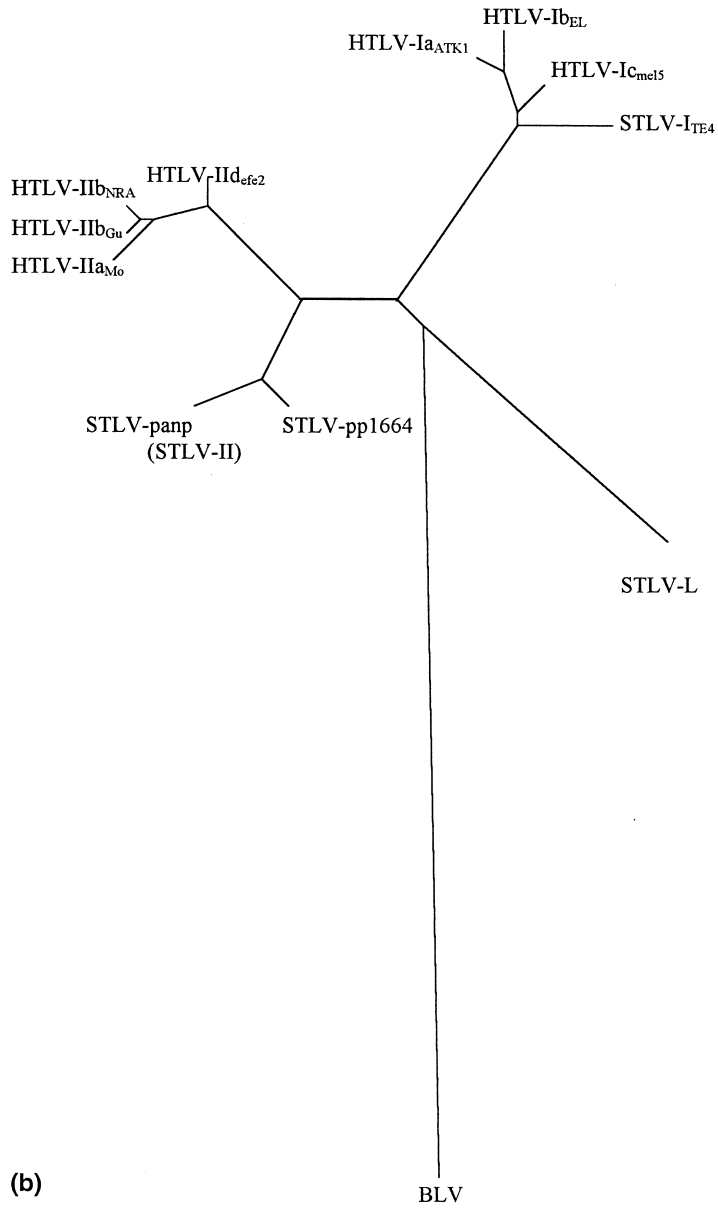

(b) The relationship between members of the HTLV-BLV family. (Modified from Van Brussel *et al.* (1998) *Virology*, **243**, 366–379)

Spain, Italy and Scandinavia, but rare in Germany and France. The recent isolation of HTLV-II from a number of African pygmy tribes (Goubau *et al.*, 1992; Gessain *et al.*, 1995) and of an HTLV-II-like primate virus in Central Africa suggests that HTLV-II, like HTLV-I, originated in Africa. However, a number of questions remain as HTLV-II is widely spread throughout the Americas but has been found in few populations in Africa. To date PTLVs have not been identified in New World primates and, with the exception of a report of HTLV-II in Mongolia, which may have been a recently imported infection, there is no population-based evidence of HTLV-II migrating from the old to the new world.

Studies in Japan show an increasing seroprevalence of HTLV-I with age. It has been suggested that this as a cohort effect; however, similar observations have been made in the Caribbean, Seychelles and Melanesia which cast doubt on this explanation.

For both viruses transmission may be by three routes: from mother-to-child; through sexual intercourse; and through blood-blood contact. Family studies in Japan suggested that HTLV-I was mainly transmitted from mother-to-child (Kajiyama *et al.*, 1986). HTLV-I was identified in lymphocytes in breast milk and transmission through breast-feeding was demonstrated in marmosets and rabbits. The mother-to-child transmission rate in Japan was 25% if babies were breast-fed, but only 5% if babies were bottle-fed. However, maternal anti-HTLV antibodies seem to protect breast-feeding infants until their titre starts to decline, so that in one study in Japan short-term breast-fed babies were no more likely to be infected than bottle-fed babies (Takahashi *et al.*, 1991). Breast-feeding for 6 months is associated with higher rates of transmission which continue to increase as weaning is further delayed. Between 3 and 5% of babies are infected despite avoidance of breast milk. Although HTLV-I has been detected in cord blood, none of these babies became infected. HTLV-I has been detected but not quantified in cervicovaginal secretions, and the contribution of *in utero* and during delivery infections to the total infection rate is uncertain. There are conflicting data on the mother-to-child transmission of HTLV-II but among the Kayapo Indians in Brazil the risk of transmission from an HTLV-II-infected mother to her child was found to be 30–50% (Ishak *et al.*, 1995).

The above family studies also indicated that infection was likely to pass from husband to wife. In a Japanese cohort study of 100 discordant couples practising unprotected sexual intercourse there were seven seroconversions during 5 years of observation. Uninfected females were 3.9 times more likely to become infected than uninfected males (Stuver *et al.*, 1993). Higher rates of transmission have been reported: 60% of wives of seropositive husbands over 10 years in one study, but only 0.4% of husbands of seropositive wives; 50% of wives during 1–4 years of marriage in another. In a study of HTLV-I and HTLV-II infected blood donors in the United States, those with higher HTLV-I proviral loads were more likely to have an infected partner. A similar association of transmission with high proviral load was seen in HTLV-II, although the viral burden is generally much less than in HTLV-I (Kaplan *et al.*, 1996). Both HTLV-I and HTLV-II are more common in females, supporting the importance of sexual transmission. It is reasonable to assume that condoms will efficiently protect against transmission.

HTLV-I is transmitted by cell-containing blood products but not by plasma or plasma-derived products. This has been demonstrated in the rabbit model and through clinical observation. Fresh blood is more infectious than older blood due to the short life of stored lymphocytes. Infection has occurred following transfusion of less than 50 ml blood. The incubation period of HTLV-I-associated myelopathy/tropical spastic paraparesis (HAM/TSP) following infection by transfusion is shorter than by other routes, and averages 3 years. Approximately 20% of HAM/TSP patients in Japan have been transfused, suggesting that transfusion-acquired infection is an important cause of HAM/TSP in endemic areas. The incidence of HAM/TSP in Japan has fallen since the introduction of blood donor screening. HTLV-I is also transmitted through intravenous drug use but this route is more commonly associated with HTLV-II. Indeed, outside of the endemic areas of America, HTLV-II is primarily transmitted through reuse of injection paraphernalia. It seems likely that HTLV-II was introduced into the IDU population of the USA during the 1970s and into Europe slightly later.

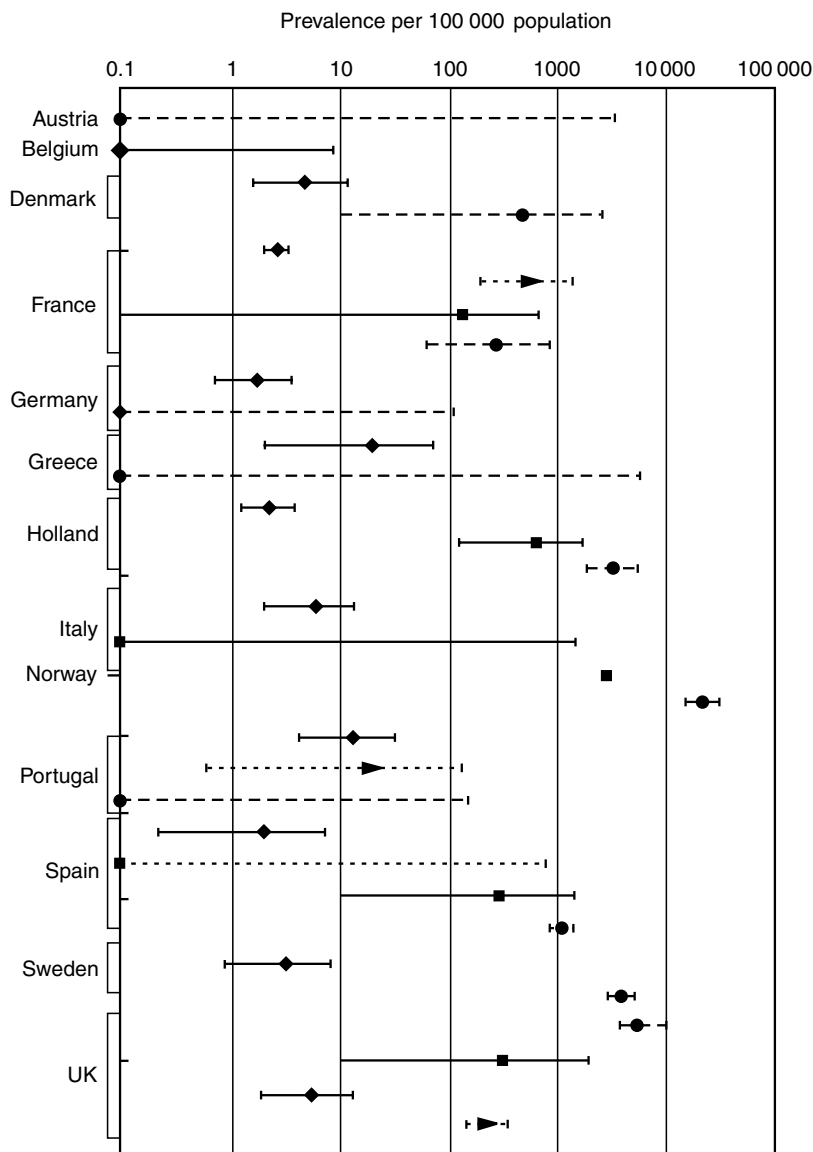

Figure 25A.5 Comparison between HTLV-I/II seroprevalence rates in different risk groups in Europe. ▼ Blood donors; ■ sexually transmitted disease clinic attenders; ▲ pregnant women; ● intravenous drug users. Rates of HTLV-I/II among European blood donors are low but relatively uniform. Rates among the three other groups tend to have much wider 95% confidence intervals due to the smaller sample size. The seroprevalence rate of (predominantly) HTLV-II among intravenous drug users are approximately 1000-fold higher than among blood donors. The seroprevalence rates of (predominantly) HTLV-I among pregnant women and among men and women attending clinics for sexually transmitted infections are approximately 100-fold higher than among blood donors. (Data from G.P. Taylor, 1996)

HTLV-ASSOCIATED DISEASE

HTLV-I is recognized as a carcinogen by the International Agency for Research on Cancer (IARC). HTLV-I is clearly associated with ATLL and

serological documentation of HTLV-I infection is an essential part of confirming this diagnosis, although demonstrating clonality is only required in unusual cases. The search for seroepidemiological evidence of an association between HTLV-I and other malignancies has been complicated by the

frequent history of previous blood transfusion in patients with malignant disease included in such studies. However, two studies have demonstrated an increased rate of cervical carcinoma in patients with HTLV-I, and in one of these studies patients with HTLV-I were also found to have more advanced disease than those not infected with HTLV-I. The significance of this association is perhaps increased by the absence of any association with ovarian carcinoma in the same study and by the biologically plausible explanation of an interaction between HTLV-I and HPV (IARC, 1996). However, since both human papilloma virus and HTLV-I are transmitted sexually, the association may reflect sexual activity rather than a biological interaction between two oncogenic viruses. Although originally described in two patients with typical hairy cell leukaemia, there are as yet no convincing data associating HTLV-II with malignancy, although it immortalizes T cells *in vitro*.

ATLL cells are CD3 + CD4 + and CD25 + (IL-2 receptor) and in the leukaemic form are characterized by the presence of polylobed 'flower' cells (Figure 25A.6). Although the cells are morphologically mature, the malignancy is aggressive and survival measured in months. Hypercalcaemia due to expression of parathroid hormone-related peptide is common. The most common presentation is acute leukaemia followed by lymphoma. Chronic and smouldering forms are associated with longer survival (Matutes and Catovsky, 1992).

HTLV-I is associated with a number of inflammatory conditions characterized by a lymphocytic infiltration of the target organ (Figure 25A.7, see Plate V). Gessain *et al.* (1985) described a high seroprevalence of HTLV-I in patients in Martinique with TSP, and Osame *et al.* (1986) described an identical condition in Japan. TSP has been described in HTLV-I uninfected patients but when HAM is diagnosed the association must of course have been shown. The disease, commonly referred to as HAM/TSP, occurs in the lifetime of 2–7% of infected persons except in Japan, where the lifetime risk in HTLV-I-infected persons has been estimated at 0.25%. HAM/TSP has been diagnosed in about 100 patients in the UK, mostly of Caribbean origin, but also in Caucasians. This includes one case following an infected blood transfusion in the UK. The condition is a chronic progressive spastic paraparesis without the relapsing/remitting character of multiple sclerosis. Chronic backache, a hyperactive

bladder and impotence are common. Sensory signs and upper limb disease are unusual but can be found in longstanding disease. The female to male ratio is 2:1 and the onset is most common in the 3rd and 4th decades, resulting in decades of morbidity. The condition is rarely fatal.

Uveitis is more common in HTLV-I patients than in the general population. Treatment with topical steroids, and less often systemic steroids, is required. The condition is generally mild but recurs in 25% of cases.

Polymyositis, alveolitis, arthritis and thyroiditis have been associated with HTLV-I, often in patients with HAM/TSP. While these associations have not been confirmed epidemiologically, the histology/cytology are characteristic. Infective dermatitis is an eczematous condition of children which only responds to long-term antibiotic treatment against streptococcal and staphylococcal species that are otherwise not usually considered pathogenic. Skin biopsies reveal an inflammatory infiltrate.

Studies in Japan have repeatedly shown reduced delayed hypersensitivity to tuberculin in HTLV-I-infected persons. Recently an increased adjusted odds risk of previous tuberculosis was reported in HTLV-II-positive blood donors in the United States (Murphy *et al.*, 1997). Encrusted (Norwegian) scabies has been reported in patients with HTLV-I and suggested as a marker for the development of ATLL. Failure to clear *Strongyloides stercoralis* despite appropriate treatment is also recognized with HTLV-I infection and investigation for HTLV-I is considered an essential part of the management of patients with proven strongyloidiasis.

HTLV-II infection is occasionally associated with myelopathy similar to that seen with HTLV-I, although some patients are also ataxic (Harrington *et al.*, 1993). In one study respiratory and urinary infections have been more common than in matched controls (Murphy *et al.*, 1997).

An association between mycosis fungoides and the presence of HTLV-I tax DNA has now been refuted. There appears to be an association between HTLV-I and Sjögren's syndrome in endemic areas but this has not yet been confirmed in properly aged-matched studies. HTLV-I-defective provirus has been amplified from the salivary glands of seronegative patients with Sjögren's syndrome. Rare cases of seronegative but PCR-positive HAM/TSP are reported with defective provirus. HTLV-I

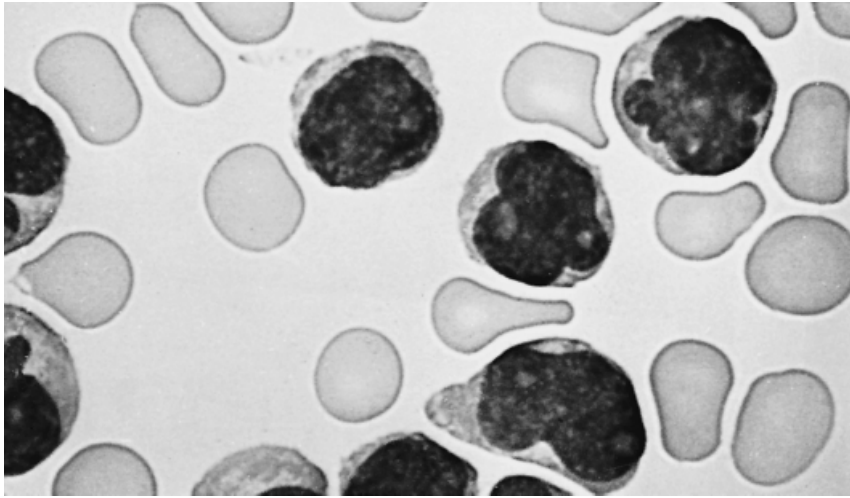

Figure 25A.6 A blood smear showing characteristic convoluted T cells in ATLL. (Courtesy of Dr E. Matutes and Professor D. Catovsky)

is also defective frequently in ATLL. *Tax* sequences are present in all these conditions. The absence of both humoral and cellular immune responses in these exceptional cases makes an understanding of the pathogenesis of these inflammatory conditions even more elusive.

PATHOGENESIS

Knowledge of the pathogenesis of ATLL is incomplete, based to a large extent on *in vitro* studies of HTLV-I and *Tax* constructs and has to take into account a number of apparent discrepancies. HTLV-I can immortalize T lymphocytes *in vitro* but there is low or absent expression of HTLV-I by adult T-cell leukaemia cells *in vivo*. Only a small proportion (2–4%) of those infected with HTLV-I develop ATLL, and then only after many decades of infection. Indeed the observation that only a proportion of the mothers of patients with HAM but all the mothers of ATLL patients are carriers of HTLV-I suggests that infection during infancy is important for the development of ATLL. In common with other malignancies it is likely that transformation is a multistep phenomenon, with the infection of a lymphocyte by HTLV-I being only one of several events leading to ATLL. Since HTLV-I does not contain an oncogene and malignant transformation is not related to the integration

disturbing cellular genes important in oncogenesis, the transactivating characteristics of *Tax* assume importance. Although adult T-cell leukaemic cells contain randomly clonally integrated HTLV-I which may be defective, *tax* is preserved (reviewed by Taylor and McClure, 1998).

Examples of the cellular genes known to be trans-activated by *Tax* are listed in Table 25A.2. These include a number of interleukins, the α chain of the IL-2 receptor, house-keeping genes, such as vimentin, and several oncogenes. *Tax* has an inhibitory effect on β -polymerase, a DNA repair gene. This may increase the likelihood of mutagenesis. *Tax* does not act directly on the cellular genes, nor indeed on the promoter sequences in the (viral) LTR, but binds to a number of specific transcription factors with resulting enhancement of their interaction with the target genes. Although others may exist, the three recognized target sequences are the cyclic AMP-response element (CRE), the NF κ B binding site and the serum responsive element (SRE). *Tax* can bind to one or several members of a family of cellular transcription factors, which in turn bind to the CRE promoters. Similarly *Tax* can bind to various members of the NF κ B family of transcription activators.

The interaction between the IL-2R α gene and *Tax* has been of particular interest because of the high expression of IL-2R (CD25) by T lymphocytes in ATLL. IL-2R α expression normally only occurs after antigenic stimulation by the T-cell receptor.

Table 25A.2 Cellular genes transactivated by HTLV-I Tax

Genes		Pathway of activation
IL-1, IL-2, IL-3, IL-6, IL-8	Interleukins	
IL-2R α	Interleukin-2 receptor α chain (CD25)	NF κ B
Vimentin	House-keeping gene	
Class 1 MHC	Human leucocyte antigens	
GM-CSF	Granulocyte-macrophage colony stimulating factor	NF κ B
NGF	Nerve growth factor	CRE
TGF β 1	Transforming growth factor	
PTHr-P	Parathyroid hormone-related protein	
TNF α , TNF β	Tumour necrosis factor (cachexin)	NF κ B
<i>c-fos</i> , <i>c-myc</i>	Cellular oncogenes (proteins localize to nucleus)	CRE
<i>c-sis</i>	Growth factor related to platelet-derived growth factor	
PCNA	Proliferating cell nuclear antigen (cyclin)	
MDR1	Multidrug resistance gene	
Early response cellular genes	E.g. <i>egr-1</i> , <i>egr-2</i>	SRE

NF κ B = nuclear factor; CRE = c-AMP response elements; SRE = serum responsive element.

However it appears that Tax is able to induce constitutive expression of the IL-2R α gene. There is a 12 bp sequence in the 5' IL-2R α gene promoter required for *tax trans*-activation which shows homology with the NF κ B binding site. The NF κ B precursor, a p105 heterodimer, is usually found in the cytoplasm because of masking of its nuclear localization signal. Tax is able to cause NF κ B to dissociate from its inhibitor, I κ B, which results in increased transport of NF κ B to the nucleus where the NF κ B p50 is able to activate transcription of IL-2R α . A secondary effect of Tax is that the dissociation of p50 from the heterodimer releases the p65 protein, which is then free to dimerize with the product of the c-Rel oncogene. This p65-Rel heterodimer is also able to activate the NF κ B motif. Thus Tax may further enhance the activation of the many genes under the influence of NF κ B.

One theory of T cell transformation by HTLV-I has been that Tax, by promoting activity of both IL-2R and IL-2 genes, gives rise to continuous proliferation of the cells by positive feedback—the autocrine loop theory. However, stimulation of Tax-transduced T cells can occur in an IL-2-independent manner, tax-transfected cells continue to grow after anti-CD3 stimulation in the absence of IL-2 and not all tax-transformed T cells express IL-2, although they all express IL-2R.

The pathogenesis of HAM/TSP is also incompletely understood. It is rare to obtain histopathology at the time of the initial symptoms but a perivascular lymphocytic infiltration of the spinal cord, which is at first CD4 + and later predomi-

nantly CD8 +, is followed by demyelination and atrophy. HTLV-I is rarely found in the lesions, and when detected is probably in circulating CD4 + lymphocytes. The peripheral lymphocyte proviral load is approximately tenfold higher in HAM/TSP than in asymptomatic carriers, although there is considerable overlap between the ranges. HTLV-I Tax-specific cytotoxic T lymphocytes (CTLs) are found in the majority of HAM/TSP patients (Jacobsen *et al.*, 1990) and asymptomatic carriers (Parker *et al.*, 1992), and by limiting dilution assays have been found in high frequency (Daenke *et al.*, 1996). Polyclonal expansion of HTLV-I-infected lymphocytes has been reported in patients (without malignancy) with high proviral load, particularly patients with HAM/TSP. As in the oligo/monoclonal proliferation of T lymphocytes in ATLL, viral replication in these cells is occurring through cell division, using cellular polymerases without the need for reverse transcription and integration. Thus, HTLV-I appears to be able to replicate through two quite distinct mechanisms, cell division and virion production. The relative contribution of 'cellular' and 'viral' replication to HTLV-I proviral load in patients with HAM/TSP and in asymptomatic carriers is uncertain. The continuous presence of a strong anti-Tax CTL response suggests continuing expression of Tax by some cells. It is possible that this may drive the proliferation of the clonally expanding cell populations.

There are three main theories concerning HAM/TSP pathogenesis: (1) the inflammatory response is directed against virus in the CNS; (2) the inflamma-

tory response against HTLV-I targets similar host CNS peptides: and (3) CNS tissue is an innocent bystander, damaged when CTLs recognize migrating, HTLV-I-expressing, CD4 + cells (Höllsberg, 1997).

Although HAM/TSP is associated with high proviral load, differences in the rates of HAM/TSP per HTLV-I infected subjects in different populations suggests that other, possibly, host factors are important. Of the candidate factors, HLA types have attracted considerable interest. HLA types are known to be associated with other inflammatory diseases but could also influence outcome by controlling viral replication. In Japanese ATLL patients HLA-A26, -B61 and -DR9 were found at an increased frequency, while HLA-A24 and HLA-Cw1 were less frequently found than in controls. Conversely, in patients with HAM/TSP, HLA-Cw7, -B7 and -DR1 were found more commonly than in controls and patients with ATLL. It has been suggested that in Japan the A26Cw3B61DR9DQ3 haplotype is representative of ATLL and is associated with a low immune response, while A24Cw7B7DR1DQ1 is the representative haplotype of HAM/TSP and is associated with a high immune response. Among different ethnic groups HLA class I haplotypes were variable but examination of class II suggested that some haplotypes associated with disease are panethnic, while others are ethnospesific (Sonoda *et al.*, 1996). HLA-A02 seems to offer some protection against HAM/TSP by more efficient control of viral replication (Jeffery *et al.*, 1999).

TREATMENT

There are very few instances of successful treatment for ATLL reported, and no reports of controlled clinical trials. Until recently the overall management has been to treat the disease not as if it were associated with a virus but as a clinical oncological problem, and the regimens for non-Hodgkin's lymphoma such as CHOP (cyclophosphamide, adriamycin, vincristine and prednisolone) are favoured. Although successive improvements in chemotherapy have increased remission rates to 42%, ATLL is essentially a highly drug-resistant malignancy: survival time remains less than 12 months for acute and lymphomatous presentations.

Enhanced transcription of the multidrug resistance gene (MDR1) with significant P glycoprotein-mediated drug efflux in the T cells of HTLV-I-infected individuals, with and without malignancy, has been demonstrated, as has the ability of HTLV tax protein to activate the MDR1 promoter. Other treatments such as deoxycyformycin, interferons β and γ , topoisomerase II and, since CD25 is expressed by all ATLL cells, anti-Tac (CD25) antibodies have been tried, with limited success. ^{99}Y -labelled anti-Tac antibodies are currently under investigation. Successful eradication, not only of ATLL cells but also of HTLV-I infection, has been reported following bone marrow transplantation (BMT) but patients often fail to survive to or through BMT. Improved remission rates and survival have been reported in uncontrolled studies by two groups using the combination of interferon α and zidovudine (Gill *et al.*, 1995, Hermine *et al.*, 1995). The mechanism of activity of these compounds in ATLL is not clear; they are not effective when given independently and do not appear to have a cytotoxic effect, although zidovudine was originally identified as a potential anticancer therapy. Interest in this treatment followed anecdotal improvement in a patient with ATLL and HIV. The immune suppression seen in patients with ATLL is more severe than in other malignancies, and prophylaxis against *Pneumocystis carinii* pneumonia is recommended.

HAM/TSP is also difficult to treat, and there have to date been no controlled studies. Early reports of the use of pulsed high-dose steroids, steroid-sparing cytotoxics and plasmapheresis, all targeting the immune response, were encouraging (Osame *et al.*, 1990) but no long-term improvements have been reported (Matsuo *et al.*, 1990). High-dose vitamin C (Kataoka *et al.*, 1993) and oxpentifylline have also been favoured (Shirabe *et al.*, 1997). Extensive research into the treatment of HIV-1 has resulted in the licensing of three classes of antiretroviral therapy. Unfortunately the protease inhibitors have no activity against HTLV-I. The nucleoside analogue reverse transcription inhibitors (NRTIs) zidovudine and zalcitabine have been shown to be active against HTLV-I *in vitro* and in animal models. Unfortunately zalcitabine and two other NRTIs, didanosine and stavudine, are neurotoxic. Zidovudine was reported to improve mobility in ambulant patients in one study (Sheremata *et al.*, 1993) but not in another (Gout *et al.*, 1991). Neither reported proviral load measurements.

When considering the management of HAM/TSP it is important to realize that in longstanding disease demyelination and atrophy may rule out improvement even if successful reduction of virus or of damaging cytokines has been effected. The bladder spasticity, frequently, nocturia and incontinence are often distressing. The anabolic steroid Danazol has been reported to improve these symptoms. Recently, intravesical instillation of capsaicin has been shown to reduce the bladder spasticity in these patients, with symptomatic improvement lasting months (Dasgupta *et al.*, 1996).

PREVENTION OF DISEASE

Although the association of HAM/TSP with high proviral load suggests that proviral load reduction with antiretroviral therapy may in the future be part of the treatment or prevention of this disease, current strategies must be directed at preventing infection. Vaccines are currently being tested in animal models. Two transmission routes can be relatively easily targeted. Many blood transfusion services now include HTLV-I/II antibody screening of all or of new donors. This was first introduced in Japan in 1985 where blood transfusion accounted for up to 60% of seroconversions in the Kyushu region of southwest Japan (Kamihira *et al.*, 1987). Blood donor screening has been standard practice in the United States and Australia for many years and has more recently been introduced in South American countries. With the commercial production of suitably sensitive and specific screening assays, HTLV-I/II blood donor testing has been introduced in the majority of EU countries. In France, 300 HTLV-I-positive blood donors have been detected since screening began in 1991, and similar numbers might be expected in the UK if screening were introduced. Screening of blood donors undoubtedly prevents infection in recipients, but cost-effectiveness in terms of preventing HTLV-I-associated disease in them has been questioned (Tynell *et al.*, 1998). In such analyses more weight has been given to the 'cost' of developing ATLL following transfusion rather than HAM/TSP, although the latter causes more morbidity. Litigation costs have not been considered in European models.

Eighty per cent of mother-to-child transmission, which gives rise to the majority of cases of ATLL,

can be prevented by avoidance of breast-feeding (Hino *et al.*, 1987). In Japan, carrier mothers are identified through antenatal screening programmes, resulting in reduced transmission in so far as these mothers refrain from breast-feeding. In the UK the prevalence of HTLV-I/II infection in women attending metropolitan antenatal clinics is approximately 1:200 (cf. HIV-1) but HTLV-I antibody testing has never been offered as a routine part of antenatal care. Although breast-feeding is less common in the UK, there is now increasing concern to prevent the transmission of other viral infections by this route and recognition that, when offered, there is a high uptake by the mothers of interventions to reduce transmission. Reduction of HTLV-I transmission from mother to infant is likely to prevent most cases of end-stage HTLV-associated disease in the UK (ATLL by preventing infection of the infant, HAM/TSP by preventing both early and later sexual transmission), although the effect on the incidence of disease would not be seen for several decades.

ACKNOWLEDGEMENTS

This chapter updates the section on HTLV from the third edition. The cooperation of Robin Weiss and Gus Dalgleish in writing this version has been invaluable, as has the constructive criticism of Dr Philip Mortimer of the Central Public Health Laboratory, Colindale.

REFERENCES

- Ciminale, V., D'Agostino, D.M., Zotti, L. *et al.* (1996) Coding potential of the X region of human T-cell leukemia/lymphotropic virus type II. *Journal of Acquired Immune Deficiency Syndrome and Human Retrovirology*, **13**(suppl. 1), S220–227.
- Clapham, P., Nagy, K. and Weiss, R.A. (1984) Pseudotypes of human T-cell leukaemia virus types 1 and 2: neutralisation by patients sera. *Proceedings of the National Academy of Sciences of the USA*, **81**, 2886–2889.
- Daenke, S., Kermonde, A., Hall, S.E. *et al.* (1996) High activated and memory cytotoxic T-cell responses to HTLV-I in healthy carriers and patients with tropical spastic paraparesis. *Virology*, **139**–146.
- Dasgupta, P., Fowler, C.J., Scaravilli, F. *et al.* (1996) Bladder biopsies in tropical spastic paraparesis and the effect of intravesical capsaicin on nerve densities. *European Urology*, **30**, S2–237 (abstract).
- Gessain, A., Vernant, J.C., Maurs, L. *et al.* (1985) Antibodies to

- human T-lymphotropic virus type-I in patients with tropical spastic paraparesis. *Lancet*, **ii**, 407–409.
- Gessain, A., Maucière, P., Froment, A. *et al.* (1995) Isolation and molecular characterisation of a human T-cell lymphotropic virus type II (HTLV-II), subtype B, from a healthy pygmy living in a remote area of Cameroon: an ancient origin for HTLV-II in Africa. *Proceedings of the National Academy of Sciences of the USA*, **92**, 4041–4045.
- Gill, P., Harrington, W., Kaplan, M. *et al.* (1995) Treatment of adult T-cell leukaemia-lymphoma with a combination of interferon- α and zidovudine. *New England Journal of Medicine*, **332**, 1744–1748.
- Giri, A., Markham, P., Digilio, L. *et al.* (1994) Isolation of a novel simian T-cell lymphotropic virus from *Pan paniscus* that is distantly related to the human T-cell leukaemia/lymphotropic virus types I and II. *Journal of Virology*, **68**, 8392–8395.
- Goulbau, P., Desmyter, J. and Ghesquiere, J. (1992) HTLV-II among pygmies (letter). *Nature*, **359**, 201.
- Goubau, P., Van Brussel, M., Vandamme, A.-M. *et al.* (1994) A primate T-lymphotropic virus, PTLV-L, different from human T-lymphotropic viruses types I and II in a wild caught baboon (*Papio hamadryas*). *Proceedings of the National Academy of Sciences of the USA*, **9**, 2848–2852.
- Gout, O., Gessain, A., Iba-Zizen, M. *et al.* (1991) The effect of zidovudine on chronic myelopathy associated with HTLV-I (letter). *Journal of Neurology*, **238**, 108–109.
- Hall, W.W., Ishak, R., Zhu, S.W. *et al.* (1996) Human T-lymphotropic virus type II (HTLV-II): epidemiology, molecular properties and clinical features of infection. *Journal of Acquired Immune Deficiency Syndrome Human Retrovirus*, **13** (suppl. 1), S204–214.
- Harrington, W.J. Jr., Sheremata, W.A., Hjelle, B. *et al.* (1993) Spastic ataxia associated with HTLV-II infection. *Annals of Neurology*, **33**, 411–414.
- Hermine, O., Bouscary, D., Gessain, A. *et al.* (1995) Treatment of HTLV-I associated adult T-cell leukaemia-lymphoma with a combination of zidovudine and interferon- α . *New England Journal of Medicine*, **332**, 1749–1751.
- Hidaka, M., Inoue, J., Yoshida, M. *et al.* (1988) Post-transcriptional regulator (rex) of HTLV-I initiates expression of viral structural proteins but suppresses expression of regulatory proteins. *EMBO J*, **7**, 519–523.
- Hino, S., Sugiyama, H., Doi, H. *et al.* (1987) Breaking the cycle of HTLV-I transmission via carrier mothers' milk (letter). *Lancet*, **ii**, 158–159.
- Hinuma, Y., Nagata, K., Hanaoka, M. *et al.* (1981) Adult T-cell leukaemia: Antigen in an ATL cell line and detection of antibodies to the antigen in human sera. *Proceedings of the National Academy of Sciences of the USA*, **78**, 6476–6480.
- Höllsberg, P. (1997) Pathogenesis of chronic progressive myelopathy associated with human T-cell lymphotropic virus type I. *Acta Neurologica Scandinavica. Supplementum*, **169**, 86–93.
- HTLV European Research Network (1996) Seroepidemiology of human T-cell leukaemia/lymphoma viruses in Europe. *Journal of Acquired Immune Deficiency Syndromes and Human Retrovirology*, **13**, 68–77.
- IARC (1996) Human immunodeficiency viruses and human T-cell lymphotropic viruses. *IARC Monographs on the Evaluation of Carcinogenic Risk to Humans*, **67**.
- Ishak, R., Harrington, W.J. Jr, Azevedo, V.N. *et al.* (1995) Identification of human T cell lymphotropic virus type IIa infection in the Kayapo, an indigenous population of Brazil. *AIDS Research and Human Retroviruses*, **11**, 813–821.
- Jacobson, S., Shida, H., McFarlin, D.E. *et al.* (1990) Circulating CD8 + cytotoxic T lymphocytes specific for HTLV-I pX in patients with HTLV-I associated neurological disease. *Nature*, **348**, 245–248.
- Jeffrey, K.J.H., Nagai, H., Hall, S.E. *et al.* (1999) HLA-A*02 protects against HAM/TSP by reducing HTLV-I proviral load. *Proceedings of the National Academy of Sciences of the USA*, **96**, 3848–3853.
- Kajiyama, W., Kashiwagi, S., Ikematsu, H. *et al.* (1986) Intrafamilial transmission of adult T leukemia virus. *Journal of Infectious Diseases*, **154**, 851–857.
- Kalyanamaraman, V.S., Sargadharan, M.G., Robert-Guroff, M. *et al.* (1982) A new subtype of human T-cell leukemia virus (HTLV-II) associated with a T-cell variant of hairy cell leukemia. *Science*, **218**, 571–573.
- Kamihira, S., Nakasima, S., Oyakawa, Y. *et al.* (1987) Transmission of human T cell lymphotropic virus type I by blood transfusion before and after mass screening of sera from seropositive donors. *Vox Sanguinis*, **52**, 43–44.
- Kaplan, J.E., Khabbaz, R.F., Murphy, E.L. *et al.* (1996) Male-to-female transmission of human T-cell lymphotropic virus types I and II: association with viral load. The Retrovirus Epidemiology Donor Study Group. *Journal of Acquired Immune Deficiency Syndromes and Human Retrovirology*, **12**, 193–201.
- Kataoka, A., Imai, H., Inayoshi, S. *et al.* (1993) Intermittent high-dose vitamin C therapy in patients with HTLV-I associated myelopathy. *Journal of Neurology, Neurosurgery and Psychiatry*, **56**, 1213–1216.
- Koralnik, I.J., Boeri, E., Saxinger, W.C. *et al.* (1994) Phylogenetic associations of human and simian T-cell leukaemia/lymphotropic virus type I strains: evidence for interspecies transmission. *Journal of Virology*, **68**, 2693–2707.
- Liu, H.-F., Vandamme, A.-M., Van Brussel, M. *et al.* (1994) New retroviruses in human and simian T-lymphotropic viruses (letter). *Lancet*, **344**, 265–266.
- Matsuo, H., Nakamura, T., Shibayama, K. *et al.* (1990) Long-term follow-up of immunomodulation in treatment of HTLV-I associated myelopathy (letter). *Lancet*, **i**, 790.
- Matutes, E. and Catovsky, D. (1992) Adult T-cell leukaemia. In *Leukaemia*, 2nd edn (ed. J.A. Whitaker), pp 416–433. Blackwell Scientific, London.
- Miyoshi, I., Kubonishi, I., Yoshimoto, S. *et al.* (1981) Type C virus particles in a cord (blood) T-cell line derived by cocultivating normal human cord leukocytes and human leukaemic T-cells. *Nature*, **294**, 770–771.
- Murphy, E.L., Glynn, S.A., Frider, J. *et al.* For the Retrovirus Epidemiology Donor Study (REDS) Study Group (1997) Increased prevalence of infectious diseases and other adverse outcomes in human T lymphotropic virus types I- and II-infected blood donors. *Journal of Infectious Diseases*, **176**, 1468–1475.
- Okochi, K., Sato, H. and Hunima, Y. (1984) A retrospective study in transmission of adult T-cell leukaemia virus by blood transfusions: seroconversion of recipients. *Vox Sanguinis*, **46**, 245–253.
- Osame, M., Usuku, K., Izumo, S. *et al.* (1986) HTLV-I associated myelopathy, a new clinical entity (letter). *Lancet*, **i**, 1031–1032.
- Osame, M., Igata, A., Matsumoto, M. *et al.* (1990) HTLV-I

- associated myelopathy (HAM). Treatment trials, retrospective survey and clinical and laboratory findings. *Hematology Reviews*, **3**, 271–284.
- Parker, C.E., Daenke, S.D., Nightingale, S. *et al.* (1992) Activated HTLV-I specific cytotoxic T lymphocytes are found in healthy seropositives as well as in patients with tropical spastic paraparesis. *Virology*, **188**, 628–636.
- Poiesz, B.J., Ruscetti, F.W., Gazdar, A.F. *et al.* (1980) Detection and isolation of type C retrovirus particles from fresh and cultured cells of a patient with cutaneous T-cell lymphoma. *Proceedings of the National Academy of Sciences of the USA*, **77**, 7415–7419.
- Sheremata, W.A., Benedict, B.S., Squilacote, D.C. *et al.* (1993) High-dose zidovudine induction in HTLV-I associated myelopathy: safety and possible efficacy. *Neurology*, **43**, 2125–2129.
- Shirabe, S., Nakamura, T., Tsujino, A. *et al.* (1997) Successful application of pentoxifylline in the treatment of HTLV-I-associated myelopathy. *Journal of Neurological Sciences*, **151**, 97–101.
- Sonoda, S., Fujiyoshi, T. and Yashiki, S. (1996) Immunogenetics of HTLV-I/II and associated disease. *Journal of Acquired Immune Deficiency Syndromes and Human Retrovirology*, **13**(suppl. 1), S119–123.
- Stuver, S.O., Tachibana, N., Okayama, A. *et al.* (1993) Heterosexual transmission of human T-cell leukaemia/lymphoma virus type I among married couples in south-western Japan: an initial report from the Miyazaki Cohort Study. *Journal of Infectious Diseases*, **167**, 57–65.
- Takahashi, K., Takezaki, T., Oki, T. *et al.* (1991) Inhibitory effect of maternal antibody on mother-to-child transmission of human T-cell lymphotropic virus type I. *International Journal of Cancer*, **49**, 673–677.
- Taylor, G.P. (1996) The epidemiology of HTLV-I in Europe. *Journal of Acquired Immune Deficiency Syndromes and Human Retrovirology*, **13** (suppl. 1), S8–14.
- Taylor, G.P. and McClure, M.O. (1998) Human oncoretroviruses. In *Viruses and Human Cancer* (eds J.R. Arrand and D.R. Harper), pp 109–142. *βios*, Oxford.
- Tynell, E., Andersson, S., Lithander, E. *et al.* (1998) Screening for human T-cell leukaemia/lymphoma virus among blood donors in Sweden; cost effectiveness analysis. *British Medical Journal*, **316**, 1417–1422.
- Uchiyama, T., Yodoi, J., Sagawa, K. *et al.* (1977) Adult T-cell leukaemia: clinical and haematological features of 16 cases. *Blood*, **50**, 481–492.
- Van Brussel, M., Salemi, M., Liu, H.-F., *et al.* (1999) The discovery of two new divergent STLVs has implications for the evolution and epidemiology of HTLV. *Reviews in Medical Virology*, **9**, in press.
- Yoshida, M., Miyoshi, I. and Hinuma, Y. (1982) A retrovirus from human leukemia cell lines: its isolation, characterization, and implication in human adult T-cell leukemia (ATL). *Prin-cess Takamatsu Symposia*, **12**, 285–294.

Human Prion Diseases

Stanley B. Prusiner

University of California, San Francisco, California, USA

INTRODUCTION

The sporadic form of Creutzfeldt–Jakob disease (CJD) is the most common prion disorder in humans. Sporadic CJD (sCJD) accounts for ~ 85% of all cases of human prion disease while inherited prion diseases account for 10–15% of all cases (Table 26.1) (Kirschbaum, 1968; Masters *et al.*, 1978). The infectious prion diseases represent a small minority and account for less than 1% of all cases. Although the transmissibility of prions is an important biological feature, infection does not seem to play an important role in the natural history of the disease in most cases. Familial CJD, Gerstmann–Sträussler–Scheinker disease (GSS), and fatal familial insomnia (FFI) are all dominantly inherited prion diseases that have been shown to be caused by mutations in the PrP gene (Hsiao *et al.*, 1989; Dlouhy *et al.*, 1992; Petersen *et al.*, 1992; Poulter *et al.*, 1992; Gabizon *et al.*, 1994). Kuru of the New Guinea Fore people is thought to have resulted from the consumption of brains from dying relatives during ritualistic cannibalism (Gajdusek, 1977). Iatrogenic CJD (iCJD) is thought to result from the accidental inoculation of patients with prions (Fradkin *et al.*, 1991).

Six diseases of animals are caused by prions (Table 26.1). Scrapie of sheep and goats is the prototypic prion disease. Mink encephalopathy, chronic wasting disease, bovine spongiform encephalopathy (BSE), feline spongiform encephalopathy and exotic ungulate encephalopathy are all thought

to occur after the consumption of prion-infected foodstuffs.

For many decades, scrapie was considered an enigmatic disorder of sheep and goats, the aetiology of which was unknown. By 1938, experimental transfer of scrapie from one sheep to goats began to argue for an infectious aetiology. Meanwhile, observations that the genetic backgrounds of flocks profoundly influence their susceptibility to scrapie raised the possibility that scrapie might be a heritable disorder. These opposing views sparked many controversial encounters and foreshadowed a series of equally bitter arguments about the possible structure of the transmissible scrapie agent (Pattison, 1988).

Although the notion of prions was initially met with considerable scepticism, the steady accumulation of experimental data over the past 10 years has created a rather convincing edifice which argues that prions are unique among all infectious pathogens (Prusiner, 1998). While the human prion diseases once presented a rather confusing picture, the finding that prion diseases may be both inherited and transmissible brought considerable clarity. The situation with the natural prion diseases of animals remains more problematic. Progress in understanding the human prion diseases has its roots in reports of familial cases, transmission to animals, discovery of the prion protein, and molecular cloning of the PrP gene.

Prions are composed largely, if not entirely, of an abnormal isoform of cellular PrP designated PrP^{Sc}.

Table 26.1 The prion diseases

Disease	Host	Mechanism of pathogenesis
Kuru	Fore people	Infection through ritualistic cannibalism
iCJD	Humans	Infection from prion-contaminated HGH, dura mater grafts, etc.
vCJD	Humans	Infection from bovine prions?
fCJD	Humans	Germline mutations in PrP gene
GSS	Humans	Germline mutations in PrP gene
FFI	Humans	Germline mutation in PrP gene (D178N, M129)
sCJD	Humans	Somatic mutation or spontaneous conversion of PrP ^C into PrP ^{S^c} ?
SFI	Humans	Somatic mutation or spontaneous conversion of PrP ^C into PrP ^{S^c} ?
Scrapie	Sheep	Infection in genetically susceptible sheep
BSE	Cattle	Infection with prion-contaminated MBM
TME	Mink	Infection with prions from sheep or cattle
CWD	Mule deer, elk	Unknown
FSE	Cats	Infection with prion-contaminated beef
Exotic ungulate encephalopathy	Greater kudu, nyala, oryx	Infection with prion-contaminated MBM

Abbreviations: BSE = bovine spongiform encephalopathy; CJD = Creutzfeldt–Jakob disease; sCJD = sporadic CJD; fCJD = familial CJD; iCJD = iatrogenic CJD; vCJD = (new) variant CJD; CWD = chronic wasting disease; FFI = fatal familial insomnia; FSE = feline spongiform encephalopathy; SFI = sporadic fatal insomnia; GSS = Gerstmann–Sträussler–Scheinker disease; HGH = human growth hormone; MBM = meat and bone meal; TME = transmissible mink encephalopathy.

PrP^{S^c} is formed from cellular PrP (PrP^C) by a post-translational process in which PrP^{S^c} acquires a high β -sheet content (Pan *et al.*, 1993). Several lines of evidence argue that PrP^{S^c} formation occurs in caveolae-like domains (CLDs) near the surface of the cell. It seems likely that a protein provisionally designated protein X facilitates the conversion of PrP^C into PrP^{S^c}.

Although genetic ablation of the PrP gene caused disease in two lines of PrP-deficient (Prnp^{0/0}) mice at about 18 months of age, two other lines remained healthy (Büeler *et al.*, 1992; Manson *et al.*, 1994; Sakaguchi *et al.*, 1996). The Prnp^{0/0} mice were resistant to scrapie and did not replicate prions (Büeler *et al.*, 1993; Prusiner *et al.*, 1993). Restoring PrP expression by genetic crosses rendered the mice susceptible to prions and made them permissive for prion replication. The susceptible mice developed disease with incubation times of less than 3 months. These findings are in accord with the inherited human prion diseases, which are autosomal dominant

disorders in which mutant PrP^C is converted into mutant PrP^{S^c} and the accumulation of PrP^{S^c} produces central nervous system (CNS) dysfunction (Gabizon *et al.*, 1996). Thus, there is no evidence that a deficiency of PrP^C is responsible for malfunction of the brain in any of the prion diseases.

PRION DISEASES ARE SPORADIC, GENETIC AND INFECTIOUS

The four human prion diseases, often referred to as kuru, CJD, GSS and FFI, are variants of the same disorder and thus share many features. The human prion diseases manifest as sporadic, genetic and infectious disorders of the CNS. All three forms of the human prion diseases have been transmitted to experimental animals (Gajdusek, 1977; Telling *et al.*, 1996b). Kuru is thought to have been spread exclusively through the infectious mechanism by

ritualistic cannibalism (Gajdusek, 1977).

Although a few CJD cases can be traced to inoculation with prions, i.e. human growth hormone (HGH), cornea transplantation and cerebral electrode implantation, most are sporadic, despite considerable efforts to implicate scrapie-infected sheep as an exogenous source of prions (Cousens *et al.*, 1990; Fradkin *et al.*, 1991). Although sCJD could be explained by prions being ubiquitous in our food chain, with their efficiency of infection being very low, there is no evidence to support this hypothesis. Of note, infection by the oral route is 10^9 times less efficient than intracerebral inoculation in hamsters. Whether or not sCJD can arise endogenously without any exogenous prion source remains to be established, but somatic mutation of the PrP gene or the infrequent spontaneous conversion of PrP^C into PrP^{Sc} seem to be likely explanations for sCJD (Prusiner, 1998).

About 10–15% of CJD and virtually all cases of GSS are inherited. Familial CJD (fCJD) and GSS as well as FFI are caused by germline mutations in the PrP gene. Five mutations of the PrP gene have been genetically linked to the development of the human prion diseases. Although some investigators argue that PrP^C is a receptor for the putative scrapie ‘virus’, and mutations in PrP^C render people more susceptible to this ubiquitous ‘virus’, considerable evidence militates against such a hypothesis.

TERMINOLOGY

The term ‘prion’ is used to denote the small proteinaceous infectious particles that lack nucleic acid (Table 26.2) (Prusiner, 1998). Prions cause scrapie and other related transmissible neurodegenerative diseases of animals and humans (Table 26.1). Prions are composed largely, if not entirely, of a protein designated as the scrapie isoform of the prion protein designated PrP^{Sc}. A post-translational conformational change generates PrP^{Sc} from the normal, cellular isoform of the prion protein denoted PrP^C. A major feature that distinguishes prions from viruses is the finding that both PrP isoforms are encoded by a chromosomal gene. In humans, the PrP gene is designated PRNP and is located on the short arm of chromosome 20. In mice, the PrP gene is designated *Prnp* and is located on chromosome 2. PrP^{Sc} is readily distinguished from PrP^C by its dif-

Table 26.2 Glossary of prion terminology

Prion	Proteinaceous infectious particle that lacks nucleic acid. Prions are composed largely, if not entirely, of PrP ^{Sc} molecules. They can cause scrapie in animals and related neurodegenerative diseases of humans such as Creutzfeldt–Jakob disease (CJD). ‘Scrapie agent’ is a synonym
PrP ^{Sc}	Scrapie isoform of the prion protein. This protein is the only identifiable macromolecule in purified preparations of scrapie prions
PrP ^C	Cellular isoform of the prion protein
PrP 27–30	Digestion of PrP ^{Sc} with proteinase K generates PrP 27–30 by truncation of the N-terminus
PRNP	PrP gene located on human chromosome 20
<i>Prnp</i>	PrP gene located on mouse chromosome 2. <i>Prnp</i> is congruent with the <i>Sinc</i> and <i>Prn-i</i> genes that control scrapie incubation times in mice
<i>Pid-1</i>	A locus on mouse chromosome 17 that appears to influence experimental CJD and scrapie incubation times
Prion rod	An aggregate of prions composed largely of PrP 27–30 molecules. Created by detergent extraction and limited proteolysis of PrP ^{Sc} . Morphologically and histochemically indistinguishable from many amyloids
PrP amyloid	Amyloid containing PrP in the brain of animals or humans with prion disease; often accumulates as plaques

ferent biochemical and biophysical properties. Limited proteolysis of PrP^{Sc} produces a smaller protease-resistant molecule of ~ 142 amino acids designated PrP 27–30; under the same conditions, PrP^C is completely hydrolysed. In the presence of detergent, PrP 27–30 polymerizes into amyloid rods. These prion amyloid rods formed by limited proteolysis and detergent extraction are indistinguishable from the filaments that aggregate to form PrP amyloid plaques in the CNS. Both the rods and the PrP amyloid filaments found in brain tissue exhibit similar ultrastructural morphology and green-gold birefringence after staining with Congo red dye. To differentiate the amyloid plaques found in the prion diseases from those found in aged brains, Alzheimer’s disease (AD) and Down’s syndrome, it has been suggested that the former be labeled PrP plaques and the latter be called A β plaques.

Four diseases of humans are caused by prions or mutations in the PrP gene (Table 26.1). Whereas kuru is confined to the mountainous Fore region of Papua New Guinea, the other three diseases are found worldwide. Distinguishing between these

three disorders has grown increasingly difficult with the recognition that fCJD, GSS and FFI are autosomal dominant diseases that are caused by mutations in the PRNP gene. Initially, we thought that a specific PrP mutation was very frequently associated with a particular clinical and neuropathological presentation. Although that is often the case, an increasing number of exceptions are beginning to accumulate. In a single family with a particular PrP mutation, different clinical and neuropathologic manifestations of the same genetic disease can be seen (Hsiao *et al.*, 1989; Johnson and Gibbs, 1998). These different constellations of CNS symptoms, signs and neuropathological lesions would seem to render the old system of classification obsolete because the precise chemical cause is now known. Instead, it has been suggested that these disorders be labelled prion diseases followed by the mutation. For example, many patients with a PrP mutation at codon 117 present with a dementing disorder, in which numerous PrP amyloid plaques characteristic of GSS are found (Doh-ura *et al.*, 1989; Hsiao *et al.*, 1991); however, other patients with the same mutation present primarily with ataxia (Mastrianni *et al.*, 1995).

Although the above proposal for a new terminology may eventually prove preferable because it is based on the molecular lesion, some clinicians currently prefer the old terminology in which CJD usually connotes a dementing illness and GSS an ataxic disorder in which numerous PrP amyloid plaques are found at autopsy. In the interest of clarity, much of the older terminology is retained in this chapter.

MEASUREMENT OF PRION INFECTIVITY

The experimental transmission of scrapie from sheep to mice (Chandler, 1961) gave investigators a more convenient laboratory model, which yielded considerable information on the nature of the unusual infectious pathogen that causes scrapie (Alper *et al.*, 1967). Yet progress was slow because quantification of infectivity in a single sample required holding 60 mice for 1 year before accurate scoring could be accomplished (Chandler, 1961).

The availability of a more rapid and economical bioassay for the scrapie agent in Syrian golden

hamsters accelerated purification of the infectious particles (Prusiner *et al.*, 1980). Bioassays for transmission of the human prion diseases to experimental animals were initially confined to apes and monkeys (Brown *et al.*, 1994). The incubation periods were quite prolonged, which made experimental studies difficult. Subsequently, CJD and GSS were transmitted to laboratory rodents; only a few animals developed disease after prolonged incubation times of 500 days or more on primary passage. Fewer cases have been transmitted to goats, marmosets, cats and laboratory rodents (Gajdusek, 1977). On second passage, the incubation time was reduced when homologous prions were inoculated. Before the molecular mechanisms responsible for prion replication were elucidated, most investigators assumed that prions that had originated in humans but were subsequently passaged in mice were different from those that had originated in sheep and were then passaged in mice. We now understand that, regardless of the origin, prions passaged in mice become mouse prions on primary passage (Prusiner, 1998). Having stated that prions passaged in mice become mouse prions on the first passage, it is noteworthy that the original strain of prions may persist or be changed when prions are passaged from one species to another.

Transgenic (Tg) mice have revolutionized the study of prion diseases. Mice expressing human (Hu) or chimeric Hu/mouse (Mo) PrP transgenes provide a much more rapid and economical means of studying Hu prions and permit the preservation of the strain of prions found in the Hu specimen (Telling *et al.*, 1996b; Prusiner, 1998). Similarly, mice expressing bovine (Bo) PrP transgenes allow the study of BSE prions (Scott *et al.*, 1997b).

PRION DISEASES OF ANIMALS

Scrapie of Sheep and Goats

Although scrapie was recognized as a distinct disorder of sheep with respect to its clinical manifestations as early as 1738, the disease remained enigmatic even with respect to its pathology for more than two centuries. Some veterinarians thought that scrapie was a disease of muscle caused by parasites, whereas others thought that it was a dystrophic process. An investigation into the aetiology of

scrapie followed the vaccination of sheep for loop-ing ill virus with formalin-treated extracts of ovine lymphoid tissue unknowingly contaminated with scrapie prions (Gordon, 1946). Two years later, more than 1500 sheep developed scrapie from this vaccine.

Even after the transmissibility of scrapie became well established, the spread of scrapie within and among flocks of sheep remained puzzling. Parry argued that host genes were responsible for the development of scrapie in sheep. He was convinced that natural scrapie is a genetic disease that could be eradicated by proper breeding protocols (Parry, 1983). He considered its transmission by inoculation of importance primarily for laboratory studies and communicable infection of little consequence in nature. Other investigators viewed natural scrapie as an infectious disease and argued that host genetics only modulates susceptibility to an endemic infectious agent. The incubation time gene for experimental scrapie in Cheviot sheep called *Sip* is said to be linked to a PrP gene restriction fragment length polymorphism (Hunter *et al.*, 1989), a situation perhaps analogous to the locus initially called *Sinc* in mice.

PrP gene Polymorphisms and Scrapie

In sheep, polymorphisms at codons 136, 154 and 171 of the PrP gene have been studied with respect to the occurrence of scrapie (Figure 26.1, *see* Plate VI) (Goldmann *et al.*, 1990a). Studies of natural scrapie in the USA have shown that ~ 85% of the afflicted sheep are of the Suffolk breed. Only those Suffolk sheep homozygous for Gln (Q) at codon 171 were found with scrapie, although healthy controls with QQ, QR and RR genotypes were also found (Westaway *et al.*, 1994). These results argue that susceptibility in Suffolk sheep is governed by the PrP codon 171 polymorphism. Indeed, sheep encoding the R/R polymorphism at position 171 seem to be resistant to scrapie (Hunter *et al.*, 1997); presumably, this was the genetic basis of Parry's scrapie eradication programme in Great Britain 30 years ago (Parry, 1983). In Cheviot sheep, the PrP codon 171 polymorphism has a profound influence on susceptibility to scrapie, as in Suffolks, but codon 136 also seems to modulate susceptibility.

Since sheep heterozygous for R171 appear equally resistant as homozygotes, the substitution of this basic residue appears to act as a dominant

negative. Studies on the mapping of the site of interaction of PrP^C with protein X provide an explanation for this phenomenon (Kaneko *et al.*, 1997). Substitution of an R in PrP^C at the site where protein X binds abolished PrP^{Sc} formation. Those studies suggested that the mutated PrP^C binds to protein X but is not released, and thus acts as a dominant negative.

Bovine Spongiform Encephalopathy

Prion strains and the species barrier are of paramount importance in understanding the BSE epidemic in Great Britain, in which it is estimated that almost one million cattle were infected with prions (Anderson *et al.*, 1996; Nathanson *et al.*, 1997). The mean incubation time for BSE is about 5 years. Most cattle therefore did not manifest disease because they were slaughtered between 2 and 3 years of age (Stekel *et al.*, 1996). Nevertheless, more than 175 000 cattle, primarily dairy cows, have died of BSE over the past decade (Figure 26.2a) (Anderson *et al.*, 1996). BSE is a massive common-source epidemic caused by meat and bone meal (MBM) fed primarily to dairy cows (Wilesmith *et al.*, 1991; Nathanson *et al.*, 1997). The MBM was prepared from the offal of sheep, cattle, pigs and chickens as a high protein nutritional supplement. In the late 1970s, the hydrocarbon-solvent extraction method used in the rendering of offal began to be abandoned, which resulted in MBM with a much higher fat content (Wilesmith *et al.*, 1991). It is now thought that this change in the rendering process allowed scrapie prions from sheep to survive rendering and to be passed into cattle. Alternatively, bovine prions were present at low levels prior to modification of the rendering process and, with the processing change, survived in sufficient numbers to initiate the BSE epidemic when inoculated back into cattle orally through MBM. Against the latter hypothesis is the widespread geographical distribution throughout England of the initial 17 cases of BSE, which occurred almost simultaneously (Wilesmith *et al.*, 1991; Nathanson *et al.*, 1997). Furthermore, there is no evidence of a pre-existing prion disease of cattle, either in Great Britain or elsewhere.

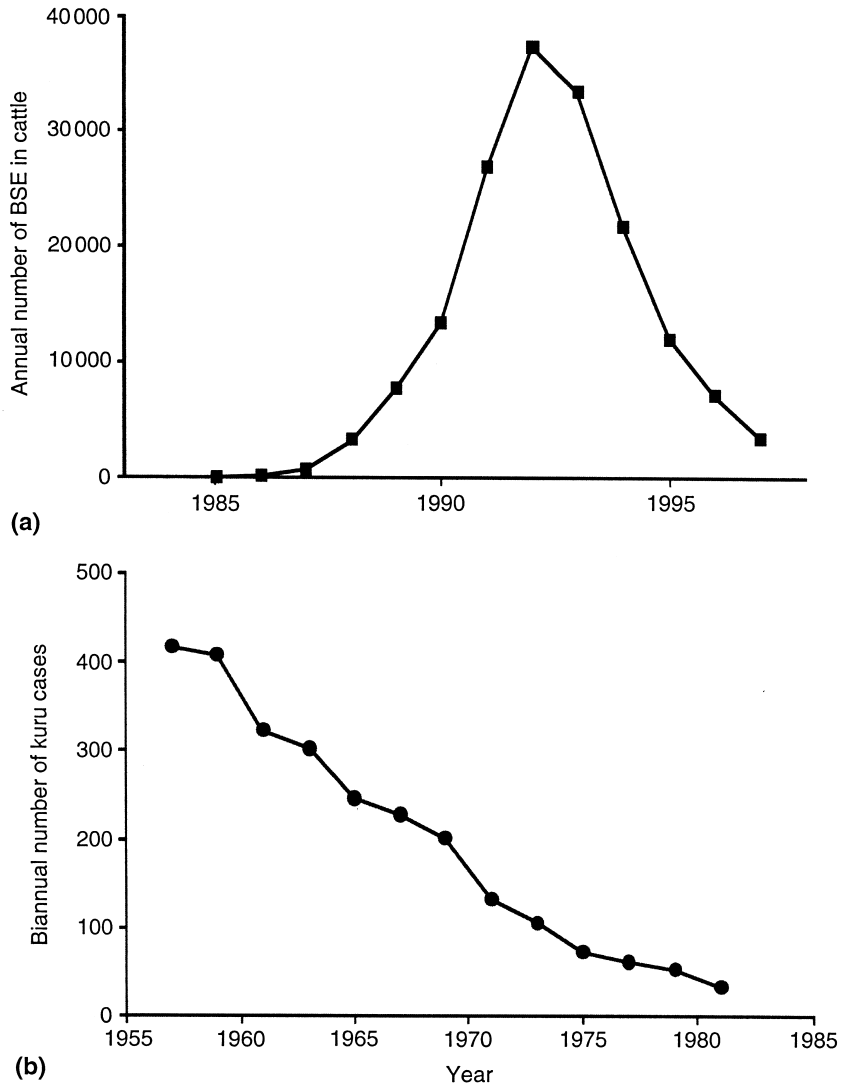

Figure 26.2 Disappearance of the kuru and BSE epidemics. (a) Number of annual cases of BSE in cattle in Great Britain. (b) Number of biannual cases of kuru in Papua New Guinea. (Data compiled for BSE by John Wilesmith and for kuru by Michael Alpers; from Prusiner, S.B. (1997) *Science*, **278**, 245–251)

Origin of BSE Prions?

The origin of the bovine prions causing BSE cannot be determined by examining the amino acid sequence of PrP^{Sc} in cattle with BSE because the PrP^{Sc} in these animals has the bovine sequence, whether the initial prions in MBM came from cattle or sheep. The bovine PrP sequence differs from that of sheep at seven or eight positions (Goldmann *et al.*, 1990b). In contrast to the many PrP polymor-

phisms found in sheep, only one PrP polymorphism has been found in cattle. Although most bovine PrP alleles encode five octarepeats, some encode six. PrP alleles encoding six octarepeats do not seem to be overrepresented in BSE (Figure 26.1, *see* Plate VI) (Hunter *et al.*, 1994).

Brain extracts from BSE cattle cause disease in cattle, sheep, mice, pigs and mink after intracerebral inoculation (Bruce *et al.*, 1997), but prions in brain extracts from sheep with scrapie fed to cattle pro-

duced illness substantially different from BSE (Robinson *et al.*, 1995). However, no exhaustive effort has been made to test different strains of sheep prions or to examine the disease following bovine to bovine passage. The annual incidence of sheep with scrapie in Britain over the past two decades has remained relatively low (J. Wilesmith, unpublished data). In July 1988, the practice of feeding MBM to sheep and cattle was banned. Recent statistics argue that the epidemic is now disappearing as a result of this ruminant feed ban (Figure 26.2a) (Anderson *et al.*, 1996), reminiscent of the disappearance of kuru in the Fore people of New Guinea (Gajdusek, 1977) (Figure 26.2b).

Monitoring Cattle for BSE Prions

Although more than 30 million cattle of age 30 months or older have been culled from herds to minimize BSE-infected tissues from entering the human food chain, it seems more important to monitor the frequency of prion infection in asymptomatic cattle. It is estimated that more than one million cattle in Great Britain were infected with BSE prions over the past 15 years (Anderson *et al.*, 1996). How much the slaughter of older cattle has reduced the apparent incidence of BSE (Figure 26.2a) is unclear.

No reliable, specific test for prion infection in live animals is available, but immunoassays for PrP^{Sc} in the brainstems of cattle might provide a reasonable approach to establishing the incidence of subclinical BSE in cattle entering the human food chain (Safar *et al.*, 1998). Determining how early in the incubation period PrP^{Sc} can be detected by immunological methods is now possible because a reliable bioassay has been created by expressing the BoPrP gene in Tg mice (Scott *et al.*, 1997b). Prior to development of Tg(BoPrP)Prnp^{0/0} mice, non-Tg mice inoculated intracerebrally with BSE brain extracts required more than 300 days to develop disease. Depending on the titre of the inoculum, the structures of PrP^C and PrP^{Sc} and the structure of protein X, the number of inoculated animals developing disease can vary over a wide range. Some investigators have stated that transmission of BSE to mice is quite variable, with incubation periods exceeding 1 year, whereas others report low prion titres in BSE brain homogenates compared to rodent brain scrapie.

SPORADIC CREUTZFELDT-JAKOB DISEASE

The recognition that the neuropathology of a cerebellar disorder of New Guinea natives was similar to that of scrapie prompted Hadlow to suggest that transmission studies in apes be performed with extracts of brain tissue from patients dying of kuru (Hadlow, 1959). The success of those studies (Gajdusek *et al.*, 1966) was followed by the transmission of CJD to apes (Gibbs *et al.*, 1968), based on the earlier recognition that the neuropathological changes in kuru were similar to those found in CJD (Figure 26.4a, *see* Plate VIII) (Klatzo *et al.*, 1959). In 1920, Creutzfeldt reported the case of a 23-year-old woman who died of a neurologic disease, and the following year Jakob reported five cases. Ironically, some investigators doubt that Creutzfeldt described the disease that now bears his name (Richardson and Masters, 1995).

Infectious, sporadic and inherited forms of CJD are now recognized. The only documented cases of the infectious form of CJD are iatrogenic. The great majority of CJD cases are sporadic, whereas 10–15% of cases are familial and inherited as an autosomal dominant trait with variable penetrance.

Epidemiology

CJD is found throughout the world. The incidence of sporadic CJD is approximately one case per million population (Masters *et al.*, 1978). Although many geographical clusters of CJD have been reported, each has been shown to segregate with a PRNP gene mutation, which results in a non-conservative substitution. Attempts to identify a common exposure to some aetiological agent have been unsuccessful, both for the sporadic and familial cases, to date (Cousens *et al.*, 1990). Some families have multiple cases of both CJD and AD. The relationship, if any, between CJD and AD remains to be established.

Ingestion of scrapie-infected sheep or goat meat as a cause of CJD in humans has not been shown by epidemiologic studies, although speculation about this potential route of inoculation continues (Johnson and Gibbs, 1998). On the other hand, it is assumed that the transmission of kuru among New Guinea tribesmen occurred after the consumption

of kuru-infected brain during ritualistic cannibalism (Gajdusek, 1977). Studies with Syrian hamsters provided convincing evidence that the oral route of inoculation, although extremely inefficient, can, with regularity, be a source of prion infection (Prusiner *et al.*, 1985).

General Clinical Features

Non-specific prodromal symptoms occur in about a third of CJD patients and may include fatigue, sleep disturbance, weight loss, headache, general malaise, and ill-defined pain (Kirschbaum, 1968; Roos *et al.*, 1973; Cathala and Baron, 1987; Johnson and Gibbs, 1998). The majority of CJD patients present with deficits in higher cortical function. These deficits virtually always progress to a state of profound dementia, characterized by memory loss, impaired judgement and a decline in virtually all aspects of intellectual function (Nevin *et al.*, 1960). A minority of patients present with either visual impairment or cerebellar gait and coordination deficits. Frequently, the cerebellar deficits are rapidly followed by progressive dementia (Gomori *et al.*, 1973). Visual problems often begin with blurred vision and diminished acuity, rapidly followed by dementia.

Generally, patients with CJD are between 50 and 75 years of age; however, patients as young as 17 and as old as 83 have been recorded (Masters *et al.*, 1978; Cathala and Baron, 1987; Holman *et al.*, 1996).

Other symptoms and signs include extrapyramidal dysfunction manifested as rigidity, mask-like facies or choreoathetoid movements; pyramidal signs (usually mild); seizures (usually major motor) and, less commonly, hypoaesthesia; supranuclear gaze palsy; optic atrophy; and vegetative signs such as changes in weight, temperature, sweating or menstruation (Kirschbaum, 1968; Cathala and Baron, 1987). One study indicates that lower motor neuron disease in association with a progressive dementing syndrome is not transmissible to apes and monkeys (Salazar *et al.*, 1983). Based on these findings, the authors argue that the term 'amyotrophic Creutzfeldt–Jakob disease' is not a useful label.

Myoclonus

Most patients (~90%) with CJD exhibit myoclonus appearing at various times throughout the illness (Kirschbaum, 1968; Roos *et al.*, 1973; Cathala and Baron, 1987). Unlike other involuntary movements, myoclonus persists during sleep. Startle myoclonus elicited by loud sounds or bright lights is frequent. It is important to stress that myoclonus is neither specific nor confined to CJD. Dementia with myoclonus can also be due to AD as well as to cryptococcal encephalitis or Unverricht–Lundborg disease, etc.

Electroencephalography

The electroencephalogram (EEG) is often useful in the diagnosis of CJD. During the early phase of CJD, the EEG is usually normal or shows only scattered theta activity. In most advanced cases, repetitive, high voltage, triphasic and polyphasic sharp discharges are seen. The presence of these stereotyped periodic bursts of < 200 ms duration, occurring every 1–2 s, makes the diagnosis of CJD very likely (Nevin *et al.*, 1960; Kirschbaum, 1968; Cathala and Baron, 1987; Johnson and Gibbs, 1998). These discharges are frequently but not always symmetrical: there may be a one-sided predominance in amplitude. As CJD progresses, normal background rhythms become fragmentary and slower. The appearance of these periodic electrical complexes during the clinical course of CJD is variable and in many cases their presence is transient.

Clinical Course

In documented cases of accidental transmission of CJD to human subjects, an incubation period of 1.5–2.0 years preceded the development of clinical disease (Duffy *et al.*, 1974; Bernoulli *et al.*, 1977). In other cases, incubation periods of up to 30 years have been suggested. Most patients with CJD live 6–12 months after the onset of clinical signs and symptoms (Kirschbaum, 1968; Masters *et al.*, 1978; Cathala and Baron, 1987), whereas some live for up to 5 years.

Clinical Diagnosis

The constellation of dementia, myoclonus, and periodic electrical bursts in an afebrile 60-year-old patient generally indicates CJD (Kirschbaum, 1968). Clinical abnormalities in CJD are confined to the CNS. Fever, elevated sedimentation rate, leucocytosis in blood or a pleocytosis in cerebrospinal fluid (CSF) should alert the physician to another aetiology to explain the patient's CNS dysfunction.

Differential Diagnosis

Many conditions may mimic CJD superficially. AD is occasionally accompanied by myoclonus but is usually distinguished by its protracted course and lack of motor and visual dysfunction (Kirschbaum, 1968; Johnson and Gibbs, 1998).

Intracranial vasculitides may produce nearly all of the symptoms and signs associated with CJD, sometimes without systemic abnormalities. Myoclonus is exceptional with cerebral vasculitis, but focal seizures may confuse the picture; furthermore, myoclonus is often absent in the early stages of CJD. Stepwise change in deficits, prominent headache, abnormal CSF fluid, and focal tomographic or angiographic abnormalities all favour vasculitis.

Neurosyphilis may present with dementia and myoclonus relatively rapidly but is easily distinguished from CJD by CSF findings, as is cryptococcal meningoencephalitis. A diffuse intracranial tumour may occasionally be confused with CJD. In rare cases of CNS neoplasia in which computerized tomography (CT) is normal and there are no signs of increased intracranial pressure, CSF protein is usually elevated. Kuf's disease and myoclonic epilepsy with Lafora bodies may be responsible for dementia, myoclonus, and ataxia, but the less acute courses and prominent seizures distinguish them from CJD (Austin and Sakai, 1976).

A number of diseases that may simulate CJD are easily discriminated by noting the clinical setting in which they occur. These include anoxic encephalopathy, subacute sclerosing panencephalitis, progressive rubella panencephalitis, herpes simplex encephalitis (in immunoincompetent hosts), dialysis dementia, uraemia and portosystemic shunt encephalopathy.

When CJD begins atypically, it may for a short

time resemble other disorders, such as Parkinson's disease, progressive supranuclear palsy or progressive multifocal leucoencephalopathy. However, this resemblance usually fades early in the course of CJD (Cathala and Baron, 1987).

The acquired immune deficiency syndrome (AIDS) dementia complex may occasionally imitate CJD in onset, early course, physical signs, CT findings and lack of abnormalities on routine CSF studies (Levy *et al.*, 1985). The few such patients without manifestations of systemic immunodeficiency (< 10%) should have enquiries into risk factors and should have serum antibodies to the human immunodeficiency virus (HIV) determined. Additionally, more specific CSF tests are likely to be abnormal; in one study, CSF oligoclonal bands were present in 6 of 9 patients, and intrablood-brain barrier synthesis of IgG specific for HIV was elevated in 8 of 9.

Ancillary Tests

With the exception of brain biopsy, there are no specific tests for CJD. EEG is the most helpful. CT may be normal or show cortical atrophy; to date, magnetic resonance imaging studies have not been more helpful. Positron emission tomography shows a loss of normal metabolic landmarks, which is felt by some to be of differential significance but by others to be indistinguishable from the pattern produced by AD. CSF is nearly always normal but may show a minimal protein elevation (Cathala and Baron, 1987). Two-dimensional gel electrophoresis of CSF proteins from CJD patients found a protein 14-3-3 that was elevated in most CJD patients. However, similar elevations of 14-3-3 levels in the CSF of patients with herpes simplex virus encephalitis, multi-infarct dementia and stroke have been found (Johnson and Gibbs, 1998; Zerr *et al.*, 1998). In AD, 14-3-3 is generally not elevated. In the serum of some patients with CJD, the S-100 protein is elevated but, as with 14-3-3, this elevation is not specific (Zerr *et al.*, 1998). The lack of specificity found with this test argues that these proteins are released into the CSF as a result of injury to the CNS.

Brain Biopsy

If the constellation of pathological changes frequently found in CJD is seen in a brain biopsy, then the diagnosis is reasonably secure (Figure 26.4a, and b, *see* Plate VIII). However, the enthusiasm for brain biopsies in patients with suspected CJD is quite low for two reasons: first, there is no specific effective treatment for CJD, and second, decontamination of surgical instruments requires special protocols, described below.

Transmission to Animals

CJD has been transmitted to a variety of laboratory animals. Over 300 cases of human prion disease have been transmitted to apes and monkeys (Brown *et al.*, 1994). Fewer cases have been transmitted to goats, marmosets, cats and laboratory rodents. Typically, only a minority of these non-primates develop prion disease after inoculation with human brain extracts from patients who died of prion disease. Moreover, the incubation times are greatly prolonged upon transmission from humans to a relatively distant species. Generally, the more similar the PrP sequences are for two species, the more readily prions are transmitted between them. After the inoculated animals develop signs of neurological dysfunction, a progressive impairment of the CNS ensues, with death following in a few weeks. With a few exceptions, the neuropathological changes in animals are roughly similar to those found in humans.

Extracts of brains from patients who died with sporadic CJD, fCJD(E200K), fCJD(V210I), and FFI readily transmit disease to mice expressing a chimeric Hu/Mo (MHu2M) PrP transgene (Telling *et al.*, 1995, 1996b). In contrast to non-Tg mice inoculated with brain extracts that required > 500 days for ~ 10% of the animals to develop CNS disease (Tateishi *et al.*, 1996), all of the Tg(MHu2M, P102L)Prnp^{0/0} mice showed signs of neurological dysfunction ~ 200 days after inoculation. Human CJD prions from British and American patients seem to transmit disease infrequently to non-Tg mice, whereas most Japanese cases readily transmit disease to ~ 10% of the inoculated animals (Tateishi *et al.*, 1996). Mice expressing appropriate PrP transgenes offer bioassays that are much shorter,

less expensive and probably more sensitive than those in non-human primates.

Immunological Studies

The rapid and reliable diagnosis of CJD post mortem can be accomplished by using antisera to PrP. Initially, partial purification of 1–2 g of infected brain tissue using detergent extractions, differential centrifugation and enzyme digestions was required to detect protease-resistant PrP^{Sc} in cases of CJD analysed by Western immunoblots (Bockman *et al.*, 1987). Brains from control patients with anoxic encephalopathy or AD did not contain these protease-resistant, immunoreactive prion proteins. Subsequently, two additional procedures were developed for diagnostic evaluations of CJD; one protocol used a dot blot whereby the sample was first digested with proteinase K and then denatured with GdnHCl (Serban *et al.*, 1990). The other protocol was designated histoblotting and utilized the same limited proteolysis followed by GdnHCl denaturation to enhance PrP^{Sc} antigenicity (Taraboulos *et al.*, 1992). These immunoassays have, for the most part, replaced transmission studies using apes and monkeys.

Numerous Western blotting studies have consistently demonstrated PrP immunoreactive proteins that are proteinase K-resistant in the brains of patients with CJD. Although there is wide agreement about the specificity of PrP^{Sc}, some investigators have tried to use migration and intensity of proteinase K-resistant PrP^{Sc} on Western blots. The usefulness of such approaches clinically remains to be established (Collinge *et al.*, 1996; Parchi *et al.*, 1996), but it has proved quite efficacious in some experimental studies (Telling *et al.*, 1996b). It is noteworthy that PrP^{Sc} is not uniformly distributed throughout the CNS so that the apparent absence of PrP^{Sc} in a limited sample such as a biopsy does not rule out prion disease. Although PrP^{Sc} is found in the thalamus of patients who die of FFI, it is frequently absent from other regions, such as the cerebral cortex and the cerebellum (Monari *et al.*, 1994).

Since considerable data indicate that PrP^{Sc} is an essential, and very probably the only, component of the prion, we expect to find PrP^{Sc} in all cases of prion disease (Prusiner, 1998). Although many cases

of human and animal prion diseases are accompanied by the accumulation of a protease-resistant form of PrP^{Sc}, protease resistance is not an absolute requirement (Telling *et al.*, 1996a).

Using a new immunoassay for PrP^{Sc} that does not depend on the protease resistance of PrP^{Sc} to distinguish it from PrP^C, it is likely that cases of prion disease will be identified in which the deposition of protease-resistant PrP^{Sc} is minimal. This conformation-dependent immunoassay (CDI) depends on the use of antibodies that react with epitopes of PrP that are exposed in PrP^C but become buried in PrP^{Sc} (Safar *et al.*, 1998). The immunoassay measures the increase in immunoreactivity that occurs when the cryptic epitopes are exposed by denaturation with GdnHCl. The assay is extremely sensitive because the antibody is labelled with Eu, which can be measured by time-resolved fluorescence (TRF); in fact, the assay is so sensitive that about 10⁵ PrP^{Sc} molecules in a sample can be measured, which is equivalent to one ID⁰ unit.

PrP immunostaining of amyloid plaques is diagnostic of prion disease, but a minority of CJD cases exhibit PrP plaques. In 16 of 17 CJD cases with amyloid plaques (94%), we have found PrP immunoreactive plaques (Roberts *et al.*, 1988). Because not all cases of CJD have readily identifiable amyloid plaques, immunostaining of tissue sections fixed in formaldehyde and embedded in paraffin is only useful when positive. The use of other fixatives such as McLean's appears to be superior to formaldehyde in preserving PrP antigenicity.

Care of Patients

It is important to stress that CJD is neither a contagious nor communicable disease, but it is transmissible. Although the risk of accidental inoculation by aerosols is very small, procedures producing aerosols should be performed in certified biosafety cabinets. Biosafety level 2 practices, containment equipment and facilities are recommended by the Centers for Disease Control and National Institutes of Health (Richardson and Barkley, 1988).

The primary problem in caring for patients with CJD is the inadvertent infection of healthcare workers by needle and stab wounds, whereas the possible transmission of a contagion through the air has never been documented. Accidental parenteral

inoculation, especially with neural tissues and including formalin-fixed specimens, is potentially very hazardous (Gorman *et al.*, 1992). Electroencephalographic and electromyographic needles should not be reused after studies on CJD patients have been performed.

There is no rational, scientific reason for surgeons or nurses to resist performing biopsies on demented patients when this operation is warranted medically. Likewise, there is no reason for pathologists or mortuary attendants to resist performing autopsies on patients whose clinical diagnosis was CJD. Progress in the diagnosis, care and treatment of CJD patients requires the dedicated efforts of physicians, nurses and other healthcare workers. The standard microbiological practices outlined here, together with specific recommendations for decontamination, seem to be adequate precautions for the care of CJD patients and the handling of infected specimens.

Decontamination of Prions

Prions are extremely resistant to common inactivation procedures (Gordon, 1946; Alper *et al.*, 1967; Gajdusek, 1977; Prusiner, 1982).

Procedures for decontamination of CJD-infected materials have been defined (Gajdusek, 1977; Brown *et al.*, 1984; Prusiner *et al.*, 1984; Richardson and Barkley, 1988). Although there is general agreement about the extreme resistance of prions to inactivation, there is some disagreement about the optimal conditions for sterilization. Little is known about the resistance of the human CJD prion to inactivation; most of our knowledge comes from animal models of experimental CJD, scrapie and BSE (Manuelidis, 1997; Taylor *et al.*, 1997). The most widely studied murine CJD model uses an isolate from a Japanese case of GSS (Tateishi *et al.*, 1996).

Although some investigators argue that GSS or CJD prions passaged into rodents retain the properties of the human CJD prion (Manuelidis, 1997), this view is erroneous and seems to emanate from the old idea that CJD is caused by a slow or unconventional virus. Once human CJD prions are passaged into mice, the resulting prion is a mouse prion. Whether or not this murine CJD prion accurately reflects the properties of human CJD prions

remains to be established.

Although some investigators recommend treating CJD-contaminated materials once with 1 N NaOH at room temperature (Brown *et al.*, 1984), we believe this procedure may be inadequate for sterilization. Autoclaving at 132°C for 5 hours or treatment with 2 N NaOH for several hours is recommended for sterilization of prions (Prusiner *et al.*, 1984). The term 'sterilization' implies complete destruction of prions; any residual infectivity can be hazardous.

The greatest possible contamination of hospital equipment will most likely occur in the neurosurgical operating room. Sterilization of surgical instruments by 2 N NaOH or autoclaving at 132°C seems mandatory, especially if the cranium has been opened. By analogy to experimental scrapie, the human CJD brain probably has higher titres of prions than any other organ. Furthermore, the intracerebral route of inoculation of scrapie prions in hamsters is approximately 10^9 times more efficient than oral ingestion (Prusiner *et al.*, 1985). These data emphasize the extreme danger of introducing small numbers of prions into the CNS tissue during neurosurgical procedures.

It has been argued that subclinical cases of CJD will harbour high titres of the infectious prions, but these will not be manifest until some time after the surgery is completed, when the patient develops a neurological disorder. Although this is particularly disconcerting, the rarity of CJD clearly indicates that very few, if any, patients develop CJD as a result of neurosurgical procedures.

The development of Tg mice that detect human prions (Telling *et al.*, 1995) and extremely sensitive immunoassays for human PrP^{Sc} using TRF (Safar *et al.*, 1998) offers the possibility of assessing the resistance of human prions to various sterilization procedures and of developing effective schemes for complete inactivation.

Prevention and Therapeutics

There is no known effective therapy for treating or preventing CJD. There are no well-documented cases of patients with CJD showing recovery, either spontaneously or after therapy, with one possible exception (Manuelidis *et al.*, 1976) for which there is no confirmatory example. Amantadine has been

used in the treatment of CJD but without any convincing success (Terzano *et al.*, 1983). When HPA-23, an inhibitor of viral glycoprotein synthesis, is given to scrapie-infected animals around the time of inoculation but not later, it profoundly extends the length of the incubation period. The effects of HPA-23 in human CJD are uncertain (Cathala and Baron, 1987). DEAE, dextran and cortisone have also extended the incubation period in experimental scrapie (Ehlers and Diringer, 1984). Interferon has been used in experimental scrapie of rodents but the incubation times were unaltered (Worthington, 1972). Although amphotericin has been used to prolong scrapie incubation periods in rodents, it is not effective in treating patients with CJD (Masullo *et al.*, 1992).

Although antibodies have been raised against the scrapie prion protein and these crossreact with prion proteins in CJD human brains, passive immunization or even vaccination would seem to be of little value. CJD and scrapie both progress in the absence of any immune response to the offending prions; however, neutralization of scrapie prion infectivity was accomplished when the infectious particles were dispersed into detergent-lipid-protein complexes (Gabizon *et al.*, 1988b).

As our understanding of prion propagation increases, it should be possible to design effective therapeutics. Because people at risk for inherited prion diseases can now be identified decades before neurological dysfunction is evident, the development of an effective therapy for these fully penetrant disorders is imperative (Chapman *et al.*, 1994). Although we have no way of predicting the number of individuals who may develop neurological dysfunction from bovine prions in the future (Cousens *et al.*, 1997), it would be prudent to seek an effective therapy now (Prusiner, 1998). Interfering with the conversion of PrP^C into PrP^{Sc} seems to be the most attractive therapeutic target. Either stabilizing the structure of PrP^C by binding a drug or modifying the action of protein X, which might function as a molecular chaperone (Figure 26.3, *see* Plate VII), are reasonable strategies. Whether it is more efficacious to design a drug that binds to PrP^C at the protein X binding site or one that mimics the structure of PrP^C with basic polymorphic residues that seem to prevent scrapie and CJD remains to be determined (Kaneko *et al.*, 1997; Shibuya *et al.*, 1998b). Because PrP^{Sc} formation seems limited to caveolae-like domains (Gorodinsky and Harris,

1995; Taraboulos *et al.*, 1995), drugs designed to inhibit this process need not penetrate the cytosol of cells but they do need to be able to enter the CNS. Alternatively, drugs that destabilize the structure of PrP^{Sc} might also prove useful.

The production of domestic animals that do not replicate prions may also be important with respect to preventing prion disease. Sheep encoding the R/R polymorphism at position 171 seem to be resistant to scrapie (Westaway *et al.*, 1994; Hunter *et al.*, 1997); presumably, this was the genetic basis of Parry's scrapie eradication programme in Great Britain 30 years ago (Parry, 1983). A more effective approach using dominant negatives for producing prion-resistant domestic animals, including sheep and cattle, is probably the expression of PrP transgenes encoding basic residues at the putative protein X binding site (Figure 26.3, *see* Plate VII) (Kaneko *et al.*, 1997). Such an approach can be readily evaluated in Tg mice and, once shown to be effective, it could be instituted by artificial insemination of sperm from males homozygous for the transgene. More difficult is the production of PrP-deficient cattle and sheep. Although such animals would not be susceptible to prion disease (Büeler *et al.*, 1993; Prusiner *et al.*, 1993), they might suffer some deleterious effects from ablation of the PrP gene (Sakaguchi *et al.*, 1996).

Whether or not gene therapy for the human prion diseases, using the dominant negative approach described above for prion-resistant animals, will prove feasible depends on the availability of efficient vectors for delivery of the transgene to the CNS.

INFECTIOUS CREUTZFELDT-JAKOB DISEASE

Infection is a rare cause of prion disease in humans. Iatrogenic CJD, kuru and possibly variant CJD in Europe are human prion diseases caused by transmission of prions from one host to another.

Iatrogenic CJD

Accidental transmission of CJD to humans appears to have occurred with corneal transplantation (Duffy *et al.*, 1974), contaminated EEG electrode

implantation (Bernouilli *et al.*, 1977) and surgical operations using contaminated instruments or apparatus (Will and Matthews, 1982). Corneas unknowingly removed from donors with CJD have been transplanted to apparently healthy recipients who developed CJD after prolonged incubation periods. Corneas of animals have significant levels of prions, which makes this scenario seem quite probable. The same improperly decontaminated EEG electrodes that caused CJD in two young patients with intractable epilepsy were found to cause CJD in a chimpanzee 18 months after their experimental implantation.

Surgical procedures may have resulted in accidental inoculation of patients with prions during their operations (Gajdusek, 1977; Will and Matthews, 1982), presumably because some instrument or apparatus in the operating theatre became contaminated when a CJD patient underwent surgery. Although the epidemiology of these studies is highly suggestive, no proof for such episodes exists.

Dura Mater Grafts

Since 1988, more than 80 cases of CJD after implantation of dura mater grafts have been recorded (Centers for Disease Control, 1997). All of the grafts were thought to have been acquired from a single manufacturer whose preparative procedures were inadequate to inactivate human prions. One case of CJD occurred after repair of an eardrum perforation with a pericardium graft (Tange *et al.*, 1989).

Human Growth Hormone Therapy

The possibility of transmission of CJD from contaminated HGH preparations derived from human pituitaries has been raised by the occurrence of fatal cerebellar disorders with dementia in 112 patients ranging in age from 10 to 41 years (Fradkin *et al.*, 1991). While one case of spontaneous CJD in a 20-year-old woman has been reported, CJD in patients under 40 years of age is very rare. These patients received injections of HGH every 2–4 days for 4–12 years (PHS, 1997). Interestingly, most of the patients presented with cerebellar syndromes that progressed over periods varying from 6 to 18

months. Some patients became demented during the terminal phase of their illnesses. The clinical courses of some patients with dementia occurring late resemble kuru more than ataxic CJD in some respects. Assuming these patients developed CJD from injections of prion-contaminated HGH preparations, the possible incubation periods range from 4 to 30 years. Incubation periods of 2–3 decades have been suggested to explain cases of kuru in recent years (Gajdusek *et al.*, 1977). Many patients received several common lots of HGH at various times during their prolonged therapies, but no single lot was administered to all the American patients. How many lots of the HGH might have been contaminated with prions is unknown. HGH from one suspect lot has been reported to transmit disease to one monkey, but no confirmatory report has been published.

Although CJD is a rare disease with an incidence of approximately one per million population (Masters *et al.*, 1978), it is reasonable to estimate that it is at least 100 times more common among dead people from whom pituitaries were taken for hormone extractions. Since 10 000 human pituitaries were typically processed in a single HGH preparation, the possibility of hormone preparations contaminated with CJD prions is not remote. The concentration of CJD prions within infected human pituitaries is unknown; it is interesting that widespread degenerative changes have been observed in both the hypothalamus and pituitary of sheep with scrapie. The forebrains from scrapie-infected mice have been added to human pituitary suspensions to determine if prions and HGH copurify. Bioassays in mice suggest that prions and HGH do not copurify with currently used protocols (Taylor *et al.*, 1985). Although these results seem reassuring, especially for patients treated with HGH over much of the last decade, the relatively low titres of the murine scrapie prions used in these studies may not have provided an adequate test. The extremely small size and charge heterogeneity exhibited by prions may complicate procedures designed to separate pituitary hormones from these slow infectious pathogens. Even though additional investigations argue for the efficacy of inactivating prions in HGH fractions prepared from human pituitaries using 6 mol l^{-1} urea, it seems doubtful that such protocols will be used for purifying HGH because recombinant HGH is available.

Four cases of CJD have occurred in women re-

ceiving human pituitary gonadotrophin (Cochius *et al.*, 1990).

Variant CJD

In 1994, the first cases of CJD in teenagers and young adults that were eventually labelled new variant (v)CJD occurred in Great Britain (Will *et al.*, 1996). Despite the young age of these patients (Bateman *et al.*, 1995; Britton *et al.*, 1995), their brains showed numerous PrP amyloid plaques surrounded by a halo of intense spongiform degeneration (Figure 26.4e, f, *see* Plate VIII) (Ironsides, 1997). Later, one French case meeting these criteria followed (Chazot *et al.*, 1996). These unusual neuropathological changes have not been seen in CJD cases in the United States, Australia or Japan (Centers for Disease Control, 1996). Both macaque monkeys and marmosets developed neurological disease several years after inoculation with bovine prions (Baker *et al.*, 1993), but only the macaques exhibited numerous PrP plaques similar to those found in vCJD.

Have Bovine Prions Been Transmitted to Humans?

The restricted geographical occurrence and chronology of vCJD have raised the possibility that BSE prions have been transmitted to humans. Only ~ 45 vCJD cases have been recorded and the incidence has remained relatively constant, which makes establishing the origin of vCJD difficult. No set of dietary habits distinguishes vCJD patients from apparently healthy people. Moreover, there is no explanation for the predilection of vCJD for teenagers and young adults. Why have older individuals not developed vCJD-based neuropathological criteria? It is noteworthy that epidemiological studies over the past three decades have failed to find evidence for transmission of sheep prions to humans (Cousens *et al.*, 1990). Attempts to predict the future number of cases of vCJD, assuming exposure to bovine prions prior to the offal ban, have been uninformative because so few cases of vCJD have occurred (Cousens *et al.*, 1997). Are we at the beginning of a human prion disease epidemic in Great Britain, like those seen for BSE and kuru (Figure 26.2), or will the number of

vCJD cases remain small, as seen with iCJD caused by cadaveric GHG (PHS, 1997)?

Strain of BSE Prions

Was a particular conformation of bovine PrP^{Sc} selected for heat resistance during the rendering process, and then reselected multiple times as cattle infected by ingesting prion-contaminated MBM were slaughtered and their offal rendered into more MBM? Recent studies of PrP^{Sc} from brains of patients who died of vCJD show a pattern of PrP glycoforms different from those found for sCJD or iCJD (Collinge *et al.*, 1996; Hill *et al.*, 1997). But the utility of measuring PrP glycoforms is questionable in trying to relate BSE to vCJD (Somerville *et al.*, 1997) because PrP^{Sc} is formed after the protein is glycosylated (Borchelt *et al.*, 1990; Caughey and Raymond, 1991) and enzymatic deglycosylation of PrP^{Sc} requires denaturation. Alternatively, it may be possible to establish a relationship between the conformations of PrP^{Sc} from cattle with BSE and those from humans with vCJD by using Tg mice, as was done for strains generated in the brains of patients with FFI or iCJD (Telling *et al.*, 1996b; Scott *et al.*, 1997b). A relationship between vCJD and BSE has been suggested by finding similar incubation times in non-Tg RIII mice of ~ 310 days after inoculation with Hu or Bo prions (Bruce *et al.*, 1997).

KURU

Kuru devastated the lives of the Fore Highlanders of Papua New Guinea (Gajdusek, 1977). The high incidence of the disease among women left a society of motherless children raised by their fathers. It was unusual in the Fore region to see an older woman. With the cessation of traditional warfare, older men are now found. Many of these older men have had a succession of wives who each died of kuru, leaving several children. Because contamination during ritualistic cannibalism appears to have been the mode of spread of kuru among the Fore people and because cannibalism had ceased by 1960 in the Fore region, the patients now developing kuru presumably were exposed to the kuru agent more than two decades ago (Gajdusek, 1977). In many cases, histories have been obtained from patients and their families of the episode in which they cannibalized

the remains of a near relative who had died of kuru, which presumably provided the source of infection. That the kuru prions could remain apparently quiescent in these patients for periods of two decades and then manifest themselves in the form of a fatal neurological disease is supported by incubation periods of over 7.5 years in some monkeys inoculated with kuru agent.

The incidence of kuru has progressively declined with the cessation of ritualistic cannibalism in the highlands of New Guinea in the late 1950s (Figure 26.2b). Each year the youngest kuru cases have been older, in accord with the hypothesis that kuru was transmitted by cannibalism (Gajdusek, 1977), even though this proposition has been challenged. The lack of eyewitness accounts of cannibalism in the Fore region has caused some scientists to ask if cannibalism was in fact the route by which kuru was transmitted.

Clinical Features

In one report describing 15 patients with kuru seen in 1978 and 1980, 13 of these received detailed neurological examinations (Prusiner *et al.*, 1982). Ten of the 15 patients were women, and all were adults. The mean age of all the patients was 40.2 years and their ages ranged from 29 to 60. The mean age of the 10 women was 43.2 years and of the five men, 34.2. Five men and four women were under 40; all those over 40 were female. The youngest patient, a male, was 29 years old. All but three of the patients lived in the South Fore, the others in the North Fore. The duration of clinical disease ranged from 5 to 22 months, the onset being taken as difficulty walking.

All 15 patients related a history of joint pain preceding the onset of difficulty walking by several months. Eleven of the 15 also reported diffuse headache as a prodromal symptom. The diagnosis of kuru was first made by the patients themselves upon recognizing that they were having difficulty walking. The rugged, mountainous terrain, which is frequently muddy from tropical rains, provided an ample test for assessing their balance on a daily basis.

Eleven of the 15 patients showed no signs of dementia at the time of examination, whereas four were disoriented and confused and had loss of memory. The latter individuals exhibited diminished

speech and frontal lobe release signs consisting of suck, snout, bite, and both hand and foot grasps. Three of the demented patients required a stick to maintain balance while standing, and one was unable to stand. With advanced kuru, truncal ataxia and tremor were so severe that the stick had to be implanted into earth, and patients with advanced disease were unable to walk without the assistance of another person. In all patients still able to walk with the assistance of a stick or an observer, marked truncal ataxia was evident.

All the patients exhibited an apprehensive facial expression, which remained unchanged for periods as long as 30 minutes. It could be interrupted, however, by laughter with other members of the village. All patients were able to smile when requested to do so. Examination of the cranial nerves revealed no abnormalities except for ataxic movements of the eyes during tests of conjugate gaze. Optokinetic nystagmus was diminished or absent bilaterally in most kuru patients, even at an early stage of the disease.

There was no evidence of muscle wasting or diminished strength, though one patient had coarse fasciculations intermittently in the triceps, quadriceps and gastrocnemius muscles. No fasciculations of the tongue were observed.

Of the 13 patients who had neurological examinations, four showed increased resistance to passive movements, while an additional seven exhibited mild rigidity with demonstrable cogwheeling. The initial clinical descriptions of kuru emphasized this aspect of the disease as well as the cerebellar dysfunction. No patient was hypotonic. Nine of the 15 patients exhibited choreiform movements. All 15 had normal strength. In 8 of 13 patients, hyperactive deep tendon reflexes were demonstrable but confined to the lower extremities. Seven patients had ankle clonus. Two showed unilateral extensor plantar responses, while two others exhibited bilateral responses. In one case a unilateral extensor plantar response was accompanied by normal deep tendon reflexes. In five patients in whom clonus at the ankles was readily elicited, no extensor plantar response was seen.

On sensory examination, responses to pinprick, temperature, touch and vibration were normal. Cortical sensory testing failed to reveal deficits.

Marked ataxia of the upper and lower extremities was pronounced in all patients, and all exhibited a prominent intention tremor. Marked difficulties

with all tests for coordination were observed. Rapid alternating movements were of uneven amplitude and rhythm.

Uniformity of Clinical Signs

The uniform clinical presentation of kuru is remarkable (Hornabrook, 1968). The prodromal symptoms and onset of the disease were similar in all the patients of one study (Prusiner *et al.*, 1982). Even the time interval between the prodromal symptoms of headache and joint pain and the onset of difficulty walking was always 6–12 weeks. In most cases the disease progressed to death within 12 months, and all patients were dead within 2 years of onset. The average duration of illness for the 15 patients in this study was 16 months (Prusiner *et al.*, 1982). Invariably, signs of cerebellar dysfunction dominate the clinical picture. All patients remain ambulatory with the aid of a stick for more than half of the clinical phase of their illness. These clinical characteristics are similar to those reported for adult patients at the peak of the kuru epidemic (Hornabrook, 1968).

There has been debate about dementia in kuru (Hornabrook, 1968). Findings of memory loss and disorientation accompanied by primitive reflexes, such as snout, bite, suck, rooting and hand grasps, leave no doubt that patients become demented at an advanced stage of the disease (Prusiner *et al.*, 1982). The same patients also exhibited considerable muscle paratonia or gegenhalten.

The uniformity of presentation and clinical course in kuru contrasts with that of CJD, in which a wide spectrum of clinical manifestations is found (Kirschbaum, 1968; Roos *et al.*, 1973). Whereas most CJD patients exhibit dementia, myoclonus and pyramidal tract dysfunction at an early stage of the clinical illness, 10–20% present with an ataxic illness (Gomori *et al.*, 1973). However, the dementia appears at an earlier clinical stage in ataxic CJD than in kuru. During the ambulatory phase of disease, no patients with kuru were found to be as severely demented as are most patients with CJD.

Incubation Periods That Exceed Three Decades

No individual born in the South Fore after 1959 has

developed kuru. Kuru has progressively disappeared, first among children and thereafter among adolescents. The number of deaths in adult females has decreased steadily and adult male deaths have remained almost invariant. No one born in a village since cannibalism ceased has ever developed kuru. Each year the youngest new patients are older than those of the previous year. These observations predict no kuru victims under the age of 40 in the future.

Of several hundred kuru orphans born since 1957 to mothers dying of kuru, none has yet developed the disease. Thus, the many children with kuru seen in the 1950s were not infected prenatally, perinatally or neonatally by their mothers. There is no evidence for transmission *in utero* or by human milk. The regular disappearance of kuru is inconsistent with the existence of any natural reservoirs for kuru besides humans. Indeed, there is no evidence for animal or insect reservoirs.

While patients currently afflicted with kuru exhibit greatly prolonged incubation periods, children with kuru who were observed 30 years ago provide some information on the minimum incubation period. The youngest patient with kuru was 4 years old at the onset of the disease and died at age 5. It is not known at what age young children were infected. Accidental transmission of CJD to humans has required only 18 months after intracerebral or intraoptical inoculation (Duffy *et al.*, 1974; Bernoulli *et al.*, 1977). An incubation period of 18 months has also been found in chimpanzees inoculated intracerebrally with the kuru agent.

Transmission by Cannibalism

Considerable evidence implicates ritualistic cannibalism as the mode of transmission for kuru among the Fore and neighboring tribes (Gajdusek, 1977). Oral transmission of kuru to monkeys has been documented. Proposed transmission routes through laceration of the skin and rubbing of the eyes remains to be established (Gajdusek, 1977). These routes were suggested when early experiments on oral transmission to apes and monkeys failed. The experimental results from oral transmission of scrapie to hamsters suggests that insufficient doses of the kuru agent or prions were used in those protocols (Prusiner *et al.*, 1985).

Origin of Kuru

It has been suggested that kuru began at the turn of the century as a spontaneous case of CJD that was propagated by ritualistic cannibalism (Gajdusek, 1977). Whether or not the Fore people and their immediate neighbours provide an especially permissive genetic background that allows multiplication of kuru prions remains to be established. Sequencing of the open reading frame of the PrP gene from three kuru patients failed to reveal any mutations. A case of CJD outside the kuru region in Papua New Guinea is noteworthy.

Transmission to Animals

Kuru has been regularly transmitted after intracerebral inoculation to apes and monkeys (Gajdusek, 1977). Occasional cases have been transmitted to cats but not to rodents. The prolonged incubation periods in experimental animals are similar to those observed with CJD and GSS. Oral transmission of kuru to apes and monkeys has been difficult (Gajdusek, 1977), but recent studies have demonstrated transmission to monkeys. Presumably, the difficulties in transmitting human kuru prions to apes and monkeys orally are due to the inefficiency of this route (Prusiner *et al.*, 1985) and the crossing of a species barrier.

GERSTMANN–STRÄUSSLER–SCHEINKER DISEASE

Gerstmann–Sträussler–Scheinker disease (GSS), also known as Sträussler's disease and Gerstmann–Sträussler syndrome, was first described by Gerstmann and coworkers in 1936 (Gerstmann *et al.*, 1936). This syndrome originally referred to a familial condition, but sporadic cases resembling GSS clinically and pathologically have been reported and are now generally included under the same rubric (Masters *et al.*, 1981). The different clinical presentations of GSS suggested that it may be a heterogeneous disorder, and it was defined as a 'spinocerebellar ataxia with dementia and plaque-like deposits'.

Molecular genetic investigations of GSS have defined four syndromes, each with a different PRNP

gene point mutation. An ataxic form of GSS is caused by a point mutation at codon 102 (Hsiao *et al.*, 1989); this mutation was also found in the original family described by Gerstmann, Sträussler and Scheinker (Gerstmann *et al.*, 1936). While a telencephalic form of GSS was eventually shown to be caused by a mutation at codon 117 (Doh-ura *et al.*, 1989; Hsiao *et al.*, 1991), an ataxic form caused by the same mutation has also been recorded (Mastrianni *et al.*, 1995). A form of GSS in which ataxia is often accompanied by parkinsonism and dementia is genetically linked to a PRNP mutation at codon 198 (Dlouhy *et al.*, 1992). In the codon 198 form of GSS, and another caused by a mutation at codon 217, PrP amyloid plaques are found surrounded by numerous neurofibrillary tangles (NFTs).

Epidemiology

GSS is rare: it comprises less than 2% of nearly 1000 cases of CJD or CJD-related diseases (Masters *et al.*, 1981). Assuming that the incidence of CJD is less than 1 per million, a rough estimate of the incidence of GSS is less than 2 per hundred million. This estimate may underrepresent GSS, because GSS frequently resembles other chronic degenerative diseases, such as spinocerebellar degeneration, olivopontocerebellar degeneration and multiple sclerosis (Masters *et al.*, 1981).

All reported cases of GSS have originated in the northern hemisphere—in Europe, Canada, the United States and Japan (Masters *et al.*, 1981). Cases from the southern hemisphere will undoubtedly be recognized in the future.

Clinical Features

The diversity of clinical manifestations in GSS, even within the same pedigree, is well documented; however, patients typically complain of difficulty walking and unsteadiness, sometimes accompanied by leg pains or paraesthesias in the early stages of the disease. On examination, cerebellar ataxia, dysarthria, ocular dysmetria, hypo- or areflexia in the lower extremities with extensor plantar responses, and mild wasting or weakness in the lower extremities may be found. Hypo- or areflexia in the lower extremities may be helpful in distinguishing GSS

from dominantly inherited olivopontocerebellar degenerations. Sensory disturbances, usually impairment of vibratory and proprioceptive sensations, are occasionally detected on examination. Later in the course, mental deterioration may occur; sometimes it is quite mild or is difficult to assess because of severe dysarthria. Dysphagia frequently develops and contributes to inanition in the late stages of disease. Deafness, blindness, gaze palsies and extrapyramidal rigidity have been reported in several cases. Convulsions may occur but are rare. Myoclonus seldom occurs; when it does, it may be confined to the lower extremities.

The majority of patients present with symptoms in the fourth to sixth decades. The average age of onset is 43 years and ranges from 24 to 66 years. Symptoms may initially be relapsing, and thus GSS can be mistaken for multiple sclerosis. Eventually, inexorable progression of symptoms leads to death. The duration of illness ranges from 1 to 11 years, with a mean of 5 years. The mean age at death is 48 years. The age of onset may vary as much as three decades within a single pedigree (Hudson *et al.*, 1983).

Clinically, GSS is thought to be distinguished from CJD by the prominence of ataxia in the former and the prominence of dementia with myoclonus in the latter. Yet, paradoxically, the clinical manifestations of both GSS and CJD may occur in different members of the same family. In one such family, the characteristic amyloid plaques of GSS were found in all afflicted members, including one member who died with a rapidly progressive dementia and myoclonus clinically consistent with CJD (Rosenthal *et al.*, 1976; Masters *et al.*, 1981). This patient's father and sister had both been afflicted with slowly progressive ataxia and little or no accompanying dementia as is characteristic for GSS. Such a pedigree raises the question of whether CJD and GSS are distinct entities and perhaps demonstrates how a single allele can be variably expressed against different genetic backgrounds.

GSS and kuru differ in duration of clinical illness (up to 5 years in GSS versus 1–2 years in kuru), morphology of amyloid plaques (multicentric in GSS versus unicentric in kuru), and mode of transmission (vertical in GSS versus horizontal in kuru). However, the symptoms and distribution of neuropathological lesions in GSS and kuru are strikingly similar, thus also calling into question whether they are separate diseases.

Genetics and Diagnostic Evaluation

Most cases of GSS are familial (Masters *et al.*, 1981), exhibiting an autosomal dominant pattern with nearly complete penetrance. The premortem diagnosis of GSS is secure if a non-conservative mutation of the PrP gene is found (Hsiao *et al.*, 1989). Before the discovery of PrP gene mutations causing GSS, the diagnosis of GSS was rarely made prior to autopsy. Biopsy of the cerebellum was occasionally diagnostic when PrP amyloid plaques were found. Serological and CSF examinations are normal. CT of the brain sometimes reveals cerebellar and brainstem atrophy. The EEG is normal or shows non-specific, diffuse changes. Periodic complexes have not been reported in GSS except in those cases whose clinical manifestations resembled CJD. Electromyography may reveal denervation potentials in lumbosacral myotomes. Sensory and motor nerve conduction velocities are normal.

Transmission to Animals

In 1978, Tateishi and coworkers produced experimental spongiform encephalopathy in mice and rats by using brain tissue from a patient with a chronic spongiform encephalopathy and kuru plaques (Tateishi *et al.*, 1996). Although this case was not thought to be familial at the time, its clinicopathological features resembled those of GSS, and subsequently Masters suggested that this case be classified as GSS (Masters *et al.*, 1981). In 1981, transmission of GSS to monkeys using brain tissue from a patient with familial disease was reported (Masters *et al.*, 1981). Subsequently, brain tissue from another afflicted member of the same family was used to transmit disease to marmosets. No diagnostic conclusions can as yet be made from such transmission studies because transmissibility of GSS appears to be variable, even within a single pedigree (Masters *et al.*, 1981).

Extracts of brains from patients who died with GSS(P102L) did not transmit disease to mice expressing a chimeric Hu/Mo (MHu2M) PrP transgene. However, they did transmit disease if this chimeric MHu2M transgene carried the P102L mutation (Telling *et al.*, 1995). In contrast to non-Tg mice inoculated with brain extracts that required > 500 days for ~ 10% of the animals to develop

CNS disease (Tateishi *et al.*, 1996), all of the Tg(MHu2M, P102L)Prnp^{0/0} mice showed signs of neurological dysfunction ~ 150 days after inoculation. Mice expressing appropriate PrP transgenes offer bioassays that are much shorter, less expensive, and probably more sensitive than those in non-human primates.

Immunological Studies

Using PrP antiserum, protease-resistant immunoreactive proteins have been demonstrated in the brain extracts of many patients with GSS (Bockman *et al.*, 1987; Tateishi *et al.*, 1990). A dot blot procedure for detection of PrP^{Sc} in brain homogenates provides a rapid and reliable method for the diagnosis of GSS, provided multiple regions of the brain are sampled (Serban *et al.*, 1990). Isolation of amyloid plaques from the brains of GSS patients and subsequent purification and sequencing of a major 11 kDa protein has shown that this protein is a proteolytic fragment of PrP (Tagliavini *et al.*, 1994).

NEUROPATHOLOGY OF THE HUMAN PRION DISEASES

The triad of microscopic features that characterizes the prion diseases consists of: (1) spongiform degeneration of neurons, (2) severe astrocytic gliosis, which often appears to be out of proportion to the degree of nerve cell loss, and (3) amyloid plaque formation (Figure 26.4, *see* Plate VIII), (DeArmond and Prusiner, 1997).

Spongiform degeneration consists of intracellular vacuoles that focally dilate neuronal processes, which gives the grey matter a microvacuolated appearance by light microscopy. Ultrastructurally, the vacuoles display splitting of the unit cell membrane with the formation of blister-like membrane expansions and multiple septa. In addition, the abnormal membranes are focally thickened and necrotic. Indeed, these neuronal membrane alterations are consistent with the prion protein being a sialoglycoprotein that, during the course of the disease, accumulates within neurons.

Selective Neuronal Targeting

In addition to measurements of the length of incubation times, neuropathological profiles of spongiform change have been used to characterize prion strains (Fraser and Dickinson, 1968). However, recent studies with PrP transgenes argue that such profiles may not reflect the intrinsic properties of strains (Carp *et al.*, 1997; DeArmond *et al.*, 1997). The mechanism by which prion strains modify the pattern of spongiform degeneration was perplexing, as earlier investigations had shown that PrP^{Sc} deposition precedes neuronal vacuolation and reactive gliosis (DeArmond *et al.*, 1987b). When FFI prions were inoculated into Tg(MHu2M) mice, PrP^{Sc} was confined largely to the thalamus (Figure 26.5a), as is the case for FFI in humans (Telling *et al.*, 1996b). In contrast, fCJD(E200K) prions inoculated into Tg(MHu2M) mice produced widespread deposition of PrP^{Sc} throughout the cortical mantle and many of the deep structures of the CNS (Figure 26.5b), as is seen in fCJD(E200K) of humans. To examine whether the diverse patterns of PrP^{Sc} deposition are influenced by Asn-linked glycosylation of PrP^C, we constructed Tg mice expressing PrPs mutated at one or both of the Asn-linked glycosylation consensus sites (DeArmond *et al.*, 1997). These mutations resulted in aberrant neuroanatomical topologies of PrP^C within the CNS, whereas pathological point mutations adjacent to the consensus sites did not alter the distribution of PrP^C. Tg mice with mutation of the second PrP glycosylation site exhibited prion incubation times of > 500 days and unusual patterns of PrP^{Sc} deposition. These findings raise the possibility that glycosylation can modify the conformation of PrP and affect either the turnover of PrP^C or the clearance of PrP^{Sc}. Regional differences in the rate of deposition or clearance would result in specific patterns of PrP^{Sc} accumulation.

Neuropathology of CJD

Frequently, the brains of patients with CJD show no recognizable abnormalities upon gross examination. In patients surviving several years, variable degrees of cerebral atrophy are likely to result in brain weights as low as 850 g.

The pathological hallmarks of CJD at the light

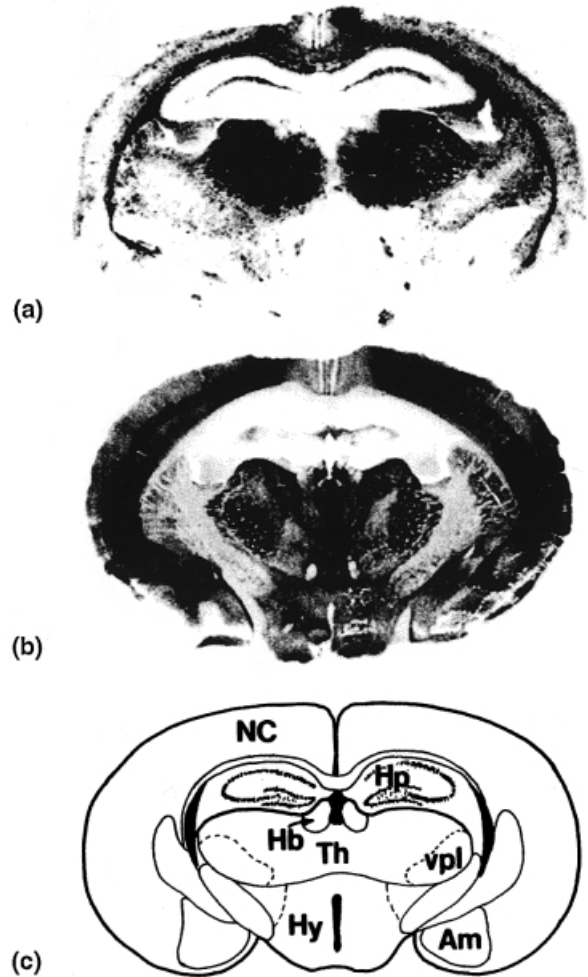

Figure 26.5 Regional distribution of PrP^{Sc} deposition in Tg(MHu2M)Prnp^{0/0} mice inoculated with prions from humans who died of inherited prion diseases. Histoblot of PrP^{Sc} deposition in a coronal section of a Tg(MHu2M)Prnp^{0/0} mouse through the hippocampus and thalamus (Telling *et al.*, 1996b). (a) The Tg mouse was inoculated with brain extract prepared from a patient who died of FFI. (b) The Tg mouse was inoculated with extract from a patient with fCJD(E200K). Cryostat sections were mounted on nitrocellulose and treated with proteinase K to eliminate PrP^C (Taraboulos *et al.*, 1992). To enhance the antigenicity of PrP^{Sc}, the histoblots were exposed to 3 mol l⁻¹ guanidinium isothiocyanate before immunostaining using α -PrP 3F4 mAb. (c) Coronal section of the hippocampus/thalamus region. NC = neocortex; Hp = hippocampus; Hb = habenula; Th = thalamus; vpl = ventral posterior lateral thalamic nucleus; Hy = hypothalamus; Am = amygdala. (From Prusiner, S.B. *et al.* (1998) *Cell*, **93**, 337–348)

microscopic level are spongiform degeneration and astrogliosis (Figure 26.4a,b, *see* Plate VIII). The lack of an inflammatory response in CJD and other prion diseases is an important pathological feature of these degenerative disorders. Generally, the spongiform changes occur in the cerebral cortex, putamen, caudate nucleus, thalamus and molecular layer of the cerebellum. Spongiform degeneration is characterized by many 1–5 μm vacuoles in the neuropil between nerve cell bodies. By electron microscopy the vacuoles appear to be swollen neuronal processes and seem to be surrounded by a membrane. Frequently, many membrane fragments can be seen within them. In some brains with CJD, we have seen no recognizable spongiform degeneration. Generally, the white matter is devoid of lesions, but several cases of CJD in Japan have exhibited well-documented vacuolar changes. In natural scrapie of sheep, vacuolization is very limited, whereas experimental scrapie of rodents is accompanied by widespread vacuolar changes. In transmissible mink encephalopathy, there is generally widespread vacuolation, but infected Aleutian mink fail to show vacuolar change (Marsh *et al.*, 1976). Thus, vacuolation, although a common feature of prion diseases, does not seem to be an obligatory change.

Astrocytic gliosis is a constant but non-specific feature of prion diseases (DeArmond and Prusiner, 1997). Widespread proliferation of fibrous astrocytes is found throughout the grey matter of brains infected with CJD prions. Astrocytic processes filled with glial filaments form extensive networks. Whether or not prions possess some glial growth or maturation activity remains to be established. Alternatively, changes in neuronal function may provoke this attendant gliosis.

Amyloid plaques have been found in 5–10% of CJD cases. Purified CJD prions from humans and animals exhibit the ultrastructural and histochemical characteristics of amyloid (Prusiner *et al.*, 1983). In first passage from some human Japanese CJD cases, amyloid plaques have been found in mouse brains (Tateishi *et al.*, 1996). These plaques stain with antisera raised against scrapie hamster PrP 27–30 protein (Roberts *et al.*, 1988).

The majority of cases of kuru show plaques that are presumably comprised of amyloid within their cores (Klatzo *et al.*, 1959). The kuru plaques differ from senile plaques in that senile plaques have a collection of amorphous material, presumably de-

generating dendrites around their amyloid core. The kuru plaques do not possess such a large halo. Both kuru and senile plaques have been reported in CJD, but they are not a constant feature of the disease. Kuru plaques do seem to be a constant feature of GSS (Masters *et al.*, 1981).

Neuropathology of GSS

The neuropathological diagnosis of GSS is based upon the presence of characteristic amyloid plaque deposition, degeneration of white matter tracts and neuronal loss throughout the brain, variably accompanied by spongiform changes and gliosis. The distribution and extent of these neuropathological changes differs widely between patients, even within one pedigree.

The amyloid plaques of GSS are distinct from those seen in kuru, AD or scrapie. GSS plaques consist of a central dense core of amyloid surrounded by smaller globules of amyloid (Figure 26.4c,d, *see* Plate VIII). Ultrastructurally, they consist of a radiating fibrillar network of amyloid fibrils with scant or no neuritic degeneration. The plaques can be distributed throughout the brain but are most frequently found in the cerebellum. They are often located adjacent to blood vessels. Congophilic angiopathy has been noted in some cases of GSS. In addition to the multicentric plaques of GSS, unicentric kuru plaques may also be seen (Masters *et al.*, 1981).

In numerous cases of GSS, there are PrP-immunoreactive proteins within the amyloid plaques (DeArmond *et al.*, 1987a; Roberts *et al.*, 1988). Thus, like CJD and kuru, the amyloid plaques of GSS specifically stain with antisera raised against PrP 27–30 isolated from scrapie-infected hamster brains. PrP immunostaining of formalin-fixed brain embedded in paraffin blocks, as well as dot blot immunostaining of PrP^{Sc} in brain homogenates, can be used to establish the diagnosis of GSS (Serban *et al.*, 1990).

The pattern of white matter degeneration resembles that of other system degenerations, such as hereditary spinocerebellar degeneration (Friedreich's), cerebellar degeneration (Marie), and dentatorubral degeneration (Ramsay Hunt). The principal tracts involved include the dorsal and ventral spinocerebellar tracts, the posterior columns, the

superior, middle and inferior cerebellar peduncles, and the corticospinal tracts.

Neuronal loss occurs in scattered areas throughout the brain and spinal cord. The nuclei and regions which may be affected include Clarke's column, anterior horn cells, vestibular and cochlear nuclei, dentate nuclei, Purkinje and granule cells in the cerebellum, pontine nuclei, inferior olive, thalamus, substantia nigra, striatum, globus pallidus, subthalamic nucleus and all layers of the cerebral cortex and hippocampus.

The presence of spongiform changes can vary even within a given pedigree (Masters *et al.*, 1981). Transmission of GSS to experimental animals was achieved only in cases with severe spongiform changes (Masters *et al.*, 1981) until Tateishi and coworkers demonstrated transmission to rodents from a case of GSS with minimal spongiform changes (Tateishi *et al.*, 1996).

Prior to the availability of immunocytochemical analyses for PrP, some cases of GSS were incorrectly diagnosed as familial AD, as histochemistry showed NFTs and amyloid plaques of the Alzheimer type. While NFTs confined to the hippocampus may be incidental, the distribution of NFTs throughout the cerebral cortex along with plaques suggests AD or the simultaneous occurrence of AD and GSS. Subsequent immunostaining studies have shown that the amyloid plaques in some of these cases are composed of prion proteins and do not bind antibodies raised to the β -amyloid peptide (Ghetti *et al.*, 1989). Molecular genetic investigations elucidated the point mutations of the PrP gene in each of these prion disorders.

Neuropathology of Kuru

The neuropathological changes in kuru are much like those described for CJD and GSS. Spongiform changes, astrogliosis and amyloid or 'kuru' plaques are the pathological hallmarks of kuru. Most but not all cases of kuru exhibit amyloid plaques (Klatzo *et al.*, 1959). These plaques have been found to contain prion proteins by immunostaining (Tateishi *et al.*, 1996).

INHERITED HUMAN PRION DISEASES

By 1930, a pedigree of the Backer family with

multiple members apparently afflicted with CJD was published. Subsequently, there were many reports of familial cases of CJD (Kirschbaum, 1968; Rosenthal *et al.*, 1976; Masters *et al.*, 1978), and in 1973, the first fCJD cases transmitted to apes and monkeys were reported (Roos *et al.*, 1973). These transmission studies followed earlier findings of the transmissibility of sporadic CJD and kuru of the Fore to apes and monkeys (Gajdusek *et al.*, 1966; Gibbs *et al.*, 1968). Subsequently, isolation of the 'CJD virus' from members of families with GSS and with Alzheimer's disease was reported (Masters *et al.*, 1981). These findings were interpreted within the framework of a viral illness occurring more frequently in some families than in others. Explanations offered for such data included: (1) spread of the CJD virus among family members living in close proximity, (2) an inherited predisposition to infection with the ubiquitous CJD virus, and (3) vertical transmission of the CJD virus from parent to offspring.

Unrelated to the foregoing observations, which had apparently provided a reasonable explanation, were developments that subsequently provided a molecular basis for diseases that are manifest as infectious, sporadic or genetic illnesses. In these seemingly unrelated studies, a protein unique to scrapie-infected hamster brains was discovered by progressively enriching fractions for scrapie infectivity (Prusiner, 1998). The protein, called PrP 27–30, was subjected to Edman degradation and the N-terminal amino acid sequence was determined. Knowledge of the PrP 27–30 sequence permitted synthesis of oligonucleotide probes that permitted recovery of cognate molecular clones encoding the protein. Subsequently, molecular clones of the human PrP gene were sequenced and mutations were found in both fCJD and GSS (Hsiao *et al.*, 1989). A genetic linkage study showed that the P102L mutation in the PrP gene was likely to be the cause of GSS (Hsiao *et al.*, 1989).

With the discovery of PrP gene mutations in the familial prion diseases, it was possible to explain how a single pathogenic process could give rise to infectious, sporadic and genetic illnesses. Within the framework of the prion hypothesis rather than the spread of a virus, it was possible to construct a consistent scenario (Prusiner, 1998). This new framework was particularly significant because concurrent epidemiological studies failed to demonstrate an infectious aetiology for sporadic CJD,

which is the most common form of prion diseases (Cousens *et al.*, 1990). However, it should be mentioned that some investigators interpreted the finding of PrP mutations as evidence for a mutant viral receptor that increases the likelihood of infection by a highly ubiquitous virus.

As evidence supporting the prion hypothesis accumulated, many additional PrP gene mutations were found in members of families afflicted with heritable prion diseases. Moreover, genetic linkage of different PrP gene mutations with the development of neurological disease and the production of transgenic mice that developed spontaneous disease when expressing mutant PrP made the virus scenario increasingly unlikely.

Human PrP Gene Mutations

GSS

The discovery of a proline (P) → leucine (L) mutation at codon 102 of the human PrP gene that was genetically linked to GSS permitted the unprecedented conclusion that prion disease can have both genetic and infectious aetiologies (Hsiao *et al.*, 1989). In that study, the codon 102 mutation was linked to development of GSS with a logarithm of the odds (LOD) score exceeding 3, demonstrating a tight association between the altered genotype and the disease phenotype (Figure 26.1). This mutation may be caused by the deamination of a methylated CpG in a germline PrP gene, resulting in the substitution of a thymine (T) for cytosine (C). The mutation has been found in many families in numerous countries, including the original GSS family.

fCJD Caused by Octarepeat Inserts

An insert of 144 bp containing six octarepeats at codon 53, in addition to the five that are normally present, was described in patients with CJD from four families residing in southern England (Poulter *et al.*, 1992). Genealogical investigations have shown that all four families are related, arguing for a single founder born more than two centuries ago. The LOD score for this extended pedigree exceeds 11. Studies from several laboratories have demonstrated that inserts of two, four, five, six, seven, eight or nine octarepeats in addition to the normal five

are found in individuals with inherited CJD (Figure 26.1).

fCJD in Libyan Jews

The unusually high incidence of CJD among Israeli Jews of Libyan origin was thought to be due to the consumption of lightly cooked sheep brain or eyeballs. Molecular genetic investigations revealed that Libyan and Tunisian Jews with fCJD have a PrP gene point mutation at codon 200 resulting in a Glu → Lys substitution (Figure 26.1) (Goldfarb *et al.*, 1990). The E200K mutation has been genetically linked to the mutation with a LOD score exceeding 3 (Gabizon *et al.*, 1993), and the same mutation has also been found in patients from Orava in North Central Slovakia, in a cluster of familial cases in Chile, and in a large German family living in the United States.

Most patients are heterozygous for the mutation, and thus express both mutant and wt PrP^C. In the brains of patients who die of fCJD(E200K), the mutant PrP^{Sc} is both insoluble and protease resistant, while much of wild-type (wt) PrP differs from both PrP^C and PrP^{Sc} in that it is insoluble but readily digested by proteases. Whether this form of PrP is an intermediate in the conversion of PrP^C into PrP^{Sc} remains to be established (Gabizon *et al.*, 1996).

Penetrance of fCJD

Life table analyses of carriers harbouring the codon 200 mutation exhibit complete penetrance (Chapman *et al.*, 1994). In other words, if the carriers live long enough, they will all eventually develop prion disease. Some investigators have argued that the inherited prion diseases are not fully penetrant, and thus an environmental factor such as the ubiquitous 'scrapie virus' is required for illness to be manifest, but, as reviewed above, no viral pathogen has been found in prion disease.

Fatal Familial Insomnia

Studies of inherited human prion diseases demonstrate that changing a single polymorphic residue at position 129 in addition to the D178N pathogenic mutation alters the clinical and neuropathological phenotype. The D178N mutation combined with a Met encoded at position 129 results in a prion

disease called fatal familial insomnia (FFI) (Figure 26.1) (Goldfarb *et al.*, 1992). In this disease, adults generally over age 50 present with a progressive sleep disorder and usually die within about a year. In their brains, deposition of PrP^{Sc} is confined largely within the anteroventral and the dorsomedial nuclei of the thalamus. The D178N mutation has been linked to the development of FFI with a LOD score exceeding 5 (Petersen *et al.*, 1992). More than 30 families with FFI have been recorded worldwide. In contrast, the same D178N mutation with a Val encoded at position 129 produces fCJD in which the patients present with dementia, and widespread deposition of PrP^{Sc} is found post mortem. The first family to be recognized with CJD was recently found to carry the D178N mutation.

Human PrP Gene Polymorphisms

The M → V polymorphism at position 129 appears able to influence prion disease expression not only in inherited forms but also in iatrogenic and sporadic forms of prion disease (Figure 26.1). A second polymorphism resulting in an amino acid substitution at codon 219 (E → K) has been reported to occur with a frequency of about 12% in the Japanese population but not in Caucasians (Shibuya *et al.*, 1998a). A third polymorphism is the deletion of a single octarepeat (24 bp) that has been found in 2.5% of Caucasians. In another study of over 700 individuals, this single octarepeat was found in 1.0% of the population.

Studies of Caucasian patients with sCJD have shown that most are homozygous for Met or Val at codon 129 (Palmer *et al.*, 1991). This contrasts with the general population, in which frequencies for the codon 129 polymorphism in Caucasians are 12% v/v, 37% m/m, and 51% m/v. In contrast, the frequency of the Val allele in the Japanese population is much lower and heterozygosity at codon 129 (m/v) is more frequent (18%) in CJD patients than in the general population, in which the polymorphism frequencies are 0% v/v, 92% m/m, and 8% m/v (Tateishi and Kitamoto, 1993).

Although no specific mutations have been identified in the PrP gene of patients with sporadic CJD, homozygosity at codon 129 in sCJD (Palmer *et al.*, 1991) is consistent with the results of Tg mouse studies. The finding that homozygosity at codon

129 predisposes to sCJD supports a model of prion production that favours PrP interactions between homologous proteins, as appears to occur in Tg mice expressing SHaPrP inoculated with either hamster prions or mouse prions (Prusiner *et al.*, 1990; Prusiner, 1991), as well as in Tg mice expressing a chimeric SHa/Mo PrP transgene inoculated with 'artificial' prions.

De Novo Generation of Prions in Tg Mice Expressing Mutant PrP

Introduction of the codon 102 point mutation found in GSS patients into the MoPrP gene resulted in Tg(MoPrP-P101L) mice that developed CNS degeneration indistinguishable from experimental murine scrapie, with neuropathology consisting of widespread spongiform morphology, astrocytic gliosis and PrP amyloid plaques (Telling *et al.*, 1996a). Brain extracts prepared from spontaneously ill Tg(MoPrP-P101L) mice transmitted CNS degeneration to Tg196 mice (Telling *et al.*, 1996a). The Tg196 mice express low levels of the mutant transgene MoPrP-P101L and do not develop spontaneous disease, whereas the Tg(MoPrP-P101L) mice expressing high levels of the mutant transgene product do develop CNS degeneration spontaneously. These studies, as well as transmission of prions from patients who died of GSS to apes, monkeys (Masters *et al.*, 1981) and Tg(MHu2M-P102L) mice (Telling *et al.*, 1995), argue persuasively that prions are generated *de novo* by mutations in PrP. In contrast to species-specific variations in PrP, all of the known point mutations in PrP occur either within or adjacent to regions of putative secondary structure in PrP and as such appear to destabilize the structure of PrP (Prusiner, 1998).

The initial attempt to detect *de novo* production of prions in uninoculated Tg(MoPrP-P101L) mice used non-Tg CD-1 mice, Syrian hamsters and the Tg196 mice. None of the CD-1 mice developed disease, whereas many of the Syrian hamsters did. We chose Syrian hamsters not as negative controls but because these animals have relatively short incubation times and thus are sensitive hosts for prion formation. How the presence of a Leu at codon 102 might alter binding of mutant PrP^{Sc} to wt PrP^C is unknown, but its place in the central region of PrP suggested the position is critical. Not unexpectedly,

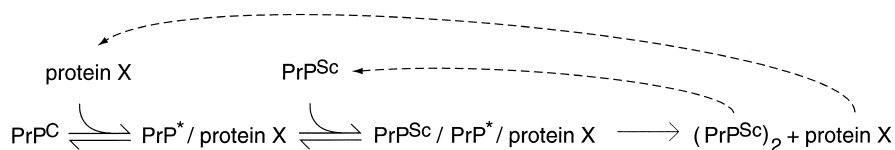

Figure 26.6 Template-assisted PrP^{Sc} formation.

In the initial step, PrP^C binds to protein X to form the PrP^{*}/protein X complex. Next, PrP^{Sc} binds to PrP^{*} that has already formed a complex with protein X. When PrP^{*} is transformed into a nascent molecule of PrP^{Sc}, protein X is released and a dimer of PrP^{Sc} remains. The inactivation target size of an infectious prion suggests that it is composed of a dimer of PrP^{Sc}. In the model depicted here, a fraction of infectious PrP^{Sc} dimers dissociate into uninfected monomers as the replication cycle proceeds, while most of the dimers accumulate in accord with the increase in prion titre that occurs during the incubation period. The precise stoichiometry of the replication process remains uncertain. (From Prusiner, S.B. *et al.* (1998) *Cell*, **93**, 337–348)

Tg196 mice expressing the mutant transgene proved to be the best hosts. It is noteworthy that extracts from the brains of patients who died with GSS (P102L) have transmitted disease to Tg(MHu2M-P102L) mice but not to Tg(MHu2M) mice (Telling *et al.*, 1995). In contrast, human prions from patients with sCJD, fCJD(E200K) and FFI have all transmitted disease to Tg(MHu2M) (Telling *et al.*, 1995, 1996b).

Why mutations of the PrP gene that produce seemingly unstable PrP^C molecules require many decades in humans to be manifest as CNS dysfunction is unknown. In Tg(MoPrP-P101L) mice, the level of expression of the mutant transgene is inversely related to the age of disease onset. In addition, the presence of the wt MoPrP gene slows the onset of disease and diminishes the severity of the neuropathological changes.

PRION REPLICATION

In an uninfected cell, PrP^C with the wt sequence exists in equilibrium in its monomeric α -helical, protease-sensitive state or bound to protein X (Figure 26.6). We denote the conformation of PrP^C that is bound to protein X as PrP^{*}; this conformation is likely to be different from that determined under aqueous conditions for monomeric recombinant PrP. The PrP^{*}/protein X complex will bind PrP^{Sc}, thereby creating a replication competent assembly. Order of addition experiments demonstrate that for PrP^C, protein X binding precedes productive PrP^{Sc} interactions (Kaneko *et al.*, 1997). A conformational change takes place wherein PrP, in a shape competent for binding to protein X and PrP^{Sc}, represents the initial phase in the formation of infectious PrP^{Sc}.

Several lines of evidence argue that the smallest infectious prion particle is an oligomer of PrP^{Sc}, perhaps as small as a dimer. Upon purification, PrP^{Sc} tends to aggregate into insoluble multimers that can be dispersed into liposomes (Gabizon *et al.*, 1988a).

In attempts to form PrP^{Sc} *in vitro*, PrP^C was exposed to 3 mol l⁻¹ GdnHCl and then diluted tenfold prior to binding to PrP^{Sc} (Kocisko *et al.*, 1994). Based on these results, we presume that exposure of PrP^C to GdnHCl converts it into a PrP^{*}-like molecule. Whether this PrP^{*}-like protein is converted into PrP^{Sc} is unclear. Although the PrP^{*}-like protein bound to PrP^{Sc} is protease resistant and insoluble, this protease-resistant PrP has not been isolated in order to assess whether or not it was converted into PrP^{Sc}. It is noteworthy that recombinant PrP can be refolded into either α -helical or β -sheet forms, but none have been found to possess prion infectivity as judged by bioassay.

Inherited and Sporadic Prion Diseases

For inherited and sporadic prion diseases, the major question is how the first PrP^{Sc} molecules are formed. Once these are formed, replication presumably follows the mechanism outlined for infectious disease. Several lines of evidence suggest that PrP^{Sc} is more stable than PrP^C, and a kinetic barrier precludes the formation of PrP^{Sc} under normal conditions. In the case of the initiation of inherited prion diseases, the barrier to PrP^{Sc} formation must be lower for the mutant (Δ PrP^C) than the wild type (wt), and thus Δ PrP^{*} can spontaneously rearrange to form Δ PrP^{Sc}. Although the known mutations would appear to be destabilizing to the structure of

PrP^C, we lack useful information about the structure of the transition state for either the mutant or wt sequences. Studies of PrP in the brains of patients who were heterozygous for the E200K mutation revealed Δ PrP^{Sc}(E200K) molecules that were both detergent insoluble and resistant to limited proteolysis, while most wt PrP was detergent insoluble but protease sensitive (Gabizon *et al.*, 1996). These results suggest that in fCJD(E200K), insoluble wt PrP might represent a form of PrP* (Gabizon *et al.*, 1996). In studies with CHO cells, expression of Δ PrP(E200K) was found to be accompanied by the post-translational acquisition of resistance to limited proteolysis (Lehmann and Harris, 1996), but such results could not be obtained when other cell lines expressing Δ PrP(E200K) were tested, including cultured fibroblasts obtained from a patient who was homozygous for the E200K mutation (Z. Meiner, R. Gabizon and S.B. Prusiner, unpublished data). It is noteworthy that levels of proteinase K used in the studies in which Δ PrP(E200K) was expressed in CHO cells were lower by a factor of 10–100 compared to digestions of PrP^{Sc} derived from brain or ScN2a cells. Whether these alterations in the properties of Δ PrP(E200K) in CHO cells provide evidence for Δ PrP* or such changes lie outside the pathway of Δ PrP^{Sc}(E200K) formation remains to be determined.

Initiation of sporadic disease may follow from a somatic mutation and thus take a path similar to that for germline mutations in inherited disease. In this situation, the mutant PrP^{Sc} must be capable of coopting wt PrP^C, a process known to be possible for some mutations (e.g. E200K, D178N) but less likely for others (e.g. P102L) (Telling *et al.*, 1995, 1996b). Alternatively, the activation barrier separating wt PrP^C from PrP^{Sc} could be crossed on rare occasions when viewed in the context of a population. Most individuals would be spared, while presentations in the elderly, with an incidence of \sim 1 per million, would be seen.

Mechanism of Prion Propagation?

From the foregoing formalism, we can ask ‘What is the rate-limiting step in prion formation?’ If the assembly of PrP^{Sc} into a specific dimeric or multimeric arrangement were difficult, then a nucleation-

polymerization (NP) formalism would be relevant. In NP processes, nucleation is the rate-limiting step, and elongation or polymerization is facile. These conditions are frequently observed in peptide models of aggregation phenomena (Jarrett and Lansbury, 1993). However, studies with Tg mice expressing foreign PrP genes suggest that a different process is operative. From investigations with mice expressing both the SHaPrP transgene and the endogenous MoPrP gene, it is clear that PrP^{Sc} provides a template for directing prion replication (Prusiner *et al.*, 1990). Inoculation of these mice with SHaPrP^{Sc} leads to the production of SHaPrP^{Sc} and not MoPrP^{Sc}. Conversely, inoculation of the Tg(SHaPrP) mice with MoPrP^{Sc} results in MoPrP^{Sc} formation and not SHaPrP^{Sc}. Even stronger evidence for templating has emerged from studies of prion strains passaged in Tg(MHu2M)Prnp^{0/0} mice expressing a chimeric Hu/MoPrP gene.

When a prion strain containing MHu2MPrP^{Sc} derived from the brains of FFI patients is passaged in Tg(MHu2M)Prnp^{0/0} mice, the molecular size of the protease-resistant core is 19 kDa, as described in more detail below. In contrast, when a prion strain containing MHu2MPrP^{Sc} derived from the brains of fCJD(E200K) patients is passaged in Tg(MHu2M)Prnp^{0/0} mice, the protease-resistant core is 21 kDa (Telling *et al.*, 1996b; Prusiner, 1998). Although the conformational templates were initially generated with PrP^{Sc} molecules having different sequences, these templates are sufficient to direct replication of distinct PrP^{Sc} molecules when the amino acid sequences of the PrPs are identical. If the formation of this template were rate limiting, then an NP model could apply. However, studies of PrP^{Sc} formation in ScN2a cells point to a distinct rate-limiting step.

Cell biological and transgenic investigations argue for the existence of a chaperone-like molecule, referred to as protein X, that is required for PrP^{Sc} formation (Telling *et al.*, 1995). As described below, mutagenesis experiments have created dominant negative forms of Δ PrP^C that block the formation of wt PrP^{Sc} by binding protein X (Kaneko *et al.*, 1997). This implies that the rate-limiting step *in vivo* in prion replication must be the conversion of PrP^C to PrP* because a dominant negative derived from a single point mutation could only gate a kinetically critical step in a cellular process. In the template-directed model, the conversion of PrP^C to

PrP* is a first-order process. By contrast, NP processes follow higher order kinetics ($[\text{monomer}]^m$ where m is the number of monomers in the nucleus). The experimental implications of these rate relationships are apparent in transgenic studies; if first-order kinetics operate, halving the gene dose (hemizygotes) should double the incubation time, while doubling the dose of a transgene array should halve the time to disease. This quantitative behaviour has been observed in several studies in mice with altered levels of PrP expression (Prusiner *et al.*, 1990; Carlson *et al.*, 1994). The existence of prion strains that are conformational isoforms of PrP^{Sc} with distinct structures, incubation times and neurohistopathology must also be considered in an analysis of the kinetics of PrP^{Sc} accumulation. Since the rate-limiting step in PrP^{Sc} formation cannot involve the unique template provided by a strain, differential rates of clearance seem most likely to account for the variation in incubation times (Safar *et al.*, 1998).

Protein X and PrP^{Sc} Formation

The passage of prions between species is often a stochastic process, almost always characterized by prolonged incubation times during the first passage in the new host (Pattison, 1965). This prolongation is often referred to as the 'species barrier'. Prions synthesized *de novo* reflect the sequence of the host PrP gene and not that of the PrP^{Sc} molecules in the inoculum derived from the donor. On subsequent passage in a homologous host, the incubation time shortens to a value that remains constant for all subsequent passages. From studies with Tg mice, three factors have been identified that contribute to the species barrier: (1) the difference in PrP sequences between the prion donor and recipient; (2) the strain of prion, and (3) the species specificity of protein X, a factor defined by molecular genetic studies that binds to PrP^C and facilitates PrP^{Sc} formation. This factor is likely to be a protein, hence the provisional designation protein X (Telling *et al.*, 1995; Kaneko *et al.*, 1997). The prion donor is the last mammal in which the prion was passaged and its PrP sequence represents the 'species' of the prion. The strain of prion, which seems to be enciphered in the conformation of PrP^{Sc}, conspires with the PrP sequence, which is specified by the

Table 26.3 Influence of prion species and strains on transmission across a species barrier

Inoculum Host		Incubation time [days \pm SEM] (n/n ₀)	
		Sc237	139H
SHa	SHa	77 \pm 1(48/48)	167 \pm 1(94/94)
SHa	non-Tg mice	> 700(0/9)	499 \pm 15(11/11)
SHa	Tg(SHaPrP)81/ FVB mice	75 \pm 2(22/22)	110 \pm 2(19/19)
SHa	Tg(SHaPrP)81/ Prnp ^{0/0} mice	54 \pm 1(9/9)	65 \pm 1(15/15)

Data from references in Prusiner (1998).

recipient, to determine the tertiary structure of nascent PrP^{Sc}. These principles are demonstrated by studies on the transmission of Syrian hamster (SHa) prions to mice, showing that expression of a SHaPrP transgene in mice abrogated the species barrier (Table 26.3). Besides the PrP sequence, the strain of prion modified transmission of SHa prions to mice (Table 26.3) (Scott *et al.*, 1997a).

Evidence for Protein X

Protein X was postulated to explain the results on the transmission of Hu prions to Tg mice (Table 26.4) (Telling *et al.*, 1995). Mice expressing both Mo and HuPrP were resistant to Hu prions, whereas those expressing only HuPrP were susceptible. These results argue that MoPrP^C inhibited transmission of Hu prions, i.e. the formation of nascent HuPrP^{Sc}. In contrast to the foregoing studies, mice expressing both MoPrP and chimeric MHu2MPrP were susceptible to Hu prions, and mice expressing MHu2MPrP alone were only slightly more susceptible. These findings contend that MoPrP^C has only a minimal effect on the formation of chimeric MHu2MPrP^{Sc}.

When the data on Hu prion transmission to Tg mice were considered together, they suggested that MoPrP^C prevented the conversion of HuPrP^C into PrP^{Sc} by binding to another Mo protein but had little effect on the conversion of MHu2M into PrP^{Sc}. We interpreted these results in terms of MoPrP^C binding to this Mo protein with a higher affinity than does HuPrP^C. We postulated that MoPrP^C had little effect on the formation of PrP^{Sc} from MHu2M (Table 26.4) because MoPrP and

Table 26.4 Evidence for protein X from transmission studies of human prions

Inoculum	Host	MoPrP gene	Incubation time [days \pm SEM] (n/n ₀)
sCJD	Tg(HuPrP)	Prnp ^{+/+}	721(1/10)
sCJD	Tg(HuPrP)Prnp ^{0/0}	Prnp ^{0/0}	263 \pm 2(6/6)
sCJD	Tg(MHu2M)	Prnp ^{+/+}	238 \pm 3(8/8)
sCJD	Tg(MHu2M)Prnp ^{0/0}	Prnp ^{0/0}	191 \pm 3(10/10)

MHu2M share the same amino acid sequence at the COOH-terminus. This also suggested that MoPrP^C only weakly inhibited transmission of SHa prions to Tg(SHaPrP) mice (Table 26.3) because SHaPrP is more closely related to MoPrP than is HuPrP.

Using scrapie-infected mouse (Mo) neuroblastoma cells transfected with chimeric Hu/Mo PrP genes, we extended our studies of protein X. Substitution of a Hu residue at position 214 or 218 prevented PrP^{Sc} formation (Figure 26.3, see Plate VII) (Kaneko *et al.*, 1997). The side chains of these residues protrude from the same surface of the COOH-terminal α helix, forming a discontinuous epitope with residues 167 and 171 in an adjacent loop. Substitution of a basic residue at positions 167, 171 or 218 prevented PrP^{Sc} formation; these mutant PrPs appear to act as 'dominant negatives' by binding protein X and rendering it unavailable for prion propagation. Our findings seem to explain the protective effects of basic polymorphic residues in PrP of humans and sheep (Westaway *et al.*, 1994; Shibuya *et al.*, 1998b).

Is Protein X a Molecular Chaperone?

Because PrP undergoes a profound structural transition during prion propagation, it seems likely that other proteins such as chaperones participate in this process. Whether protein X functions as a classical molecular chaperone or participates in PrP binding as part of its normal function but can also facilitate pathogenic aspects of PrP biology is unknown. Interestingly, scrapie-infected cells in culture display marked differences in the induction of heat-shock proteins (Tatzelt *et al.*, 1995), and Hsp70 mRNA has been reported to increase in scrapie of mice (Kenward *et al.*, 1994). Although attempts to isolate specific proteins that bind to PrP have been disappointing, PrP has been shown to interact with Bcl-2

and Hsp60 by two-hybrid analysis in yeast (Edenhofer *et al.*, 1996; Kurschner and Morgan, 1996). Weiss and coworkers have used a similar approach to show that PrP binds the laminin receptor protein (Weiss, 1997). Although these studies are suggestive, no molecular chaperone involved in prion formation in mammalian cells has been identified.

STRAINS OF PRIONS

The existence of prion strains raises the question of how heritable biological information can be enciphered in a molecule other than nucleic acid (Dickinson *et al.*, 1968; Bruce and Dickinson, 1987; Weissmann, 1991; Ridley and Baker, 1996). Strains or varieties of prions have been defined by incubation times and the distribution of neuronal vacuolation (Dickinson *et al.*, 1968; Fraser and Dickinson, 1973). Subsequently, the patterns of PrP^{Sc} deposition were found to correlate with vacuolation profiles and these patterns were also used to characterize strains of prions (DeArmond *et al.*, 1987b; Bruce *et al.*, 1989).

The typing of prion strains in C57Bl, VM and F1(C57Bl x VM) inbred mice began with isolates from sheep with scrapie. The prototypic strains, called Me7 and 22A, gave incubation times of \sim 150 and \sim 400 days in C57Bl mice, respectively (Dickinson *et al.*, 1968; Bruce and Dickinson, 1987). The PrPs of C57Bl and I/Ln (and later VM) mice differ at two residues and control incubation times (Carlson *et al.*, 1994; Moore *et al.*, 1998).

Until recently, support for the hypothesis that the tertiary structure of PrP^{Sc} enciphers strain-specific information (Prusiner, 1991) was minimal except for the DY strain isolated from mink with transmissible encephalopathy (Bessen and Marsh, 1994). PrP^{Sc} in DY prions showed diminished resistance to proteinase K digestion as well as an anomalous

Table 26.5 Distinct prion strains generated in humans with inherited prion diseases and transmitted to transgenic mice

Inoculum	Host species	Host PrP genotype	Incubation time [days \pm SEM] (n/n ₀)	PrP ^{Sc} (kDa)
None	Human	FFI(D178N, M129)		19
FFI	Mouse	Tg(MHu2M)	206 \pm 7(7/7)	19
FFI \rightarrow Tg(MHu2M)	Mouse	Tg(MHu2M)	136 \pm 1(6/6)	19
None	Human	fCJD(E200K)		21
fCJD	Mouse	Tg(MHu2M)	170 \pm 2(10/10)	21
fCJD \rightarrow Tg(MHu2M)	Mouse	Tg(MHu2M)	167 \pm 3(15/15)	21

Data from Prusiner (1998) and Telling *et al.* (1996b).

site of cleavage. The DY strain presented a puzzling anomaly because other prion strains exhibiting similar incubation times did not show this altered susceptibility to proteinase K digestion of PrP^{Sc} (Scott *et al.*, 1997a). Also notable was the generation of new strains during passage of prions through animals with different PrP genes (Scott *et al.*, 1997a).

PrP^{Sc} Conformation Enciphers Variation in Prions

Persuasive evidence that strain-specific information is enciphered in the tertiary structure of PrP^{Sc} comes from transmission of two different inherited human prion diseases to mice expressing a chimeric MHu2MPrP transgene (Telling *et al.*, 1996b). In FFI, the protease-resistant fragment of PrP^{Sc} after deglycosylation has an M_r of 19 kDa, whereas in fCJD(E200K) and most sporadic prion diseases, it is 21 kDa (Table 26.5) (Monari *et al.*, 1994; Parchi *et al.*, 1996). This difference in molecular size was shown to be due to different sites of proteolytic cleavage at the NH₂-termini of the two human PrP^{Sc} molecules reflecting different tertiary structures (Monari *et al.*, 1994). These distinct conformations were not unexpected because the amino acid sequences of the PrPs differ.

Extracts from the brains of FFI patients transmitted disease into mice expressing a chimeric MHu2MPrP gene about 200 days after inoculation and induced formation of the 19 kDa PrP^{Sc}, whereas fCJD(E200K) and sCJD produced the 21 kDa PrP^{Sc} in mice expressing the same transgene (Telling *et al.*, 1996b). On second passage, Tg(MHu2M) mice inoculated with FFI prions showed an incuba-

tion time of \sim 130 days and a 19 kDa PrP^{Sc}, whereas those inoculated with fCJD(E200K) prions exhibited an incubation time of \sim 170 days and a 21 kDa PrP^{Sc} (Prusiner, 1998). The experimental data demonstrate that MHu2MPrP^{Sc} can exist in two different conformations based on the sizes of the protease-resistant fragments; yet the amino acid sequence of MHu2MPrP^{Sc} is invariant.

The results of our studies argue that PrP^{Sc} acts as a template for the conversion of PrP^C into nascent PrP^{Sc}. Imparting the size of the protease-resistant fragment of PrP^{Sc} through conformational templating provides a mechanism for both the generation and propagation of prion strains.

Interestingly, the protease-resistant fragment of PrP^{Sc} after deglycosylation with an M_r of 19 kDa has been found in a patient who died after developing a clinical disease similar to FFI. As both PrP alleles encoded the wt sequence and a Met at position 129, we labelled this case fatal sporadic insomnia (FSI). At autopsy, the spongiform degeneration, reactive astrogliosis and PrP^{Sc} deposition were confined to the thalamus (Mastrianni *et al.*, 1997). These findings argue that the clinicopathological phenotype is determined by the conformation of PrP^{Sc} in accord with the results of the transmission of human prions from patients with FFI to Tg mice (Telling *et al.*, 1996b).

Evidence for Different Conformations of PrP^{Sc} in Eight Prion Strains

A highly sensitive CDI that discriminated PrP^{Sc} molecules among eight different prion strains propagated in Syrian hamsters was developed (Safar *et al.*, 1998). This immunoassay for PrP^{Sc} does

not depend on the protease resistance of PrP^{Sc} to distinguish it from PrP^C but instead utilizes antibodies that react with epitopes of PrP that are exposed in PrP^C but become buried in PrP^{Sc}. The CDI measures the increase in immunoreactivity that occurs when the cryptic epitopes are exposed by denaturation with GdnHCl. The assay is extremely sensitive because the antibody is labelled with europium (Eu), which can be measured by TRF.

Brains from Syrian hamsters were collected when the animals displayed signs of neurological dysfunction; the incubation times for the prion strains varied from 70 to 320 days. Most of the PrP in the brains of Syrian hamsters with signs of neurological disease was PrP^{Sc}, as defined by the β -sheet conformation. The level of PrP^{Sc} in the brains of these clinically ill animals exceeded that of PrP^C by three- to ten-fold as determined by CDI (Figure 26.7a). The highest levels of PrP^{Sc} were found in the brains of Syrian hamsters infected with the Me7-H strain; in contrast, the lowest levels were found in the brains of Syrian hamsters inoculated with the SHa(Me7) strain (Figure 26.7a). Interestingly, the Me7-H and SHa(Me7) strains, which were both derived from Me7 passaged in mice (Scott *et al.*, 1997a), possessed similar denatured/native PrP ratios, but they accumulated PrP^{Sc} at quite different levels (Figure 26.7a,b). The highest denatured/native PrP ratio of all tested strains was SHa(RML).

In a plot of the ratio of antibody binding to denatured/native PrP graphed as a function of the concentration of PrP^{Sc}, each strain occupied a unique position, indicative of a particular PrP^{Sc} conformation (Figure 26.7b,c) (Safar *et al.*, 1998). This conclusion was supported by a unique pattern of equilibrium unfolding of PrP^{Sc} found with each strain. When the incubation times of these eight strains were plotted as a function of the concentration of either PrP^{Sc} or PrP 27–30, no relationship could be discerned. Incubation times were also plotted as a function of the ratio of denatured/native PrP and again no correlation could be found.

In contrast to the lack of any correlation with incubation times noted above, an excellent correlation was found when the proteinase K-sensitive fraction of PrP^{Sc} ($[\text{PrP}^{\text{Sc}}] - [\text{PrP } 27-30]$) was plotted as a function of the incubation time for all eight prion strains (Figure 26.7d) (Safar *et al.*, 1998). The proteinase K-sensitive fraction of PrP^{Sc} can be considered a surrogate for PrP^{Sc} clearance. Since the binding of PrP^C or a metastable intermediate PrP*

to protein X seems to be the rate-limiting step in prion replication (Kaneko *et al.*, 1997), it follows that the different incubation times of various prion strains should arise predominantly from distinct rates of PrP^{Sc} clearance rather than from the different rates of PrP^{Sc} formation. In accord with the excellent correlation between proteinase K-sensitive PrP^{Sc} and incubation times, prion strains that seem to be readily cleared have prolonged incubation times, whereas those that are poorly cleared display abbreviated incubation periods. However, it is important to recognize that proteinase K sensitivity is an imperfect model for *in vivo* clearance and that only one strain with a long incubation time exceeding 300 days has been studied.

PRIONS ARE UNPRECEDENTED

Although the study of prions has taken several unexpected directions over the past three decades, a novel and fascinating story of prion biology is emerging. Investigations of prions have elucidated a previously unknown mechanism of disease in humans and animals. Although learning the details of the structures of PrPs and deciphering the mechanism of PrP^C transformation into PrP^{Sc} will be important, the fundamental principles of prion biology have become reasonably clear. Although some investigators prefer to view the composition of the infectious prion particle as unresolved, such a perspective denies an enlarging body of data, none of which refutes the prion concept. Moreover, the discovery of prion-like phenomena mediated by proteins unrelated to PrP in yeast and other fungi serve not only to strengthen the prion concept but also to widen it (Wickner, 1997).

The discovery that prion diseases in humans are uniquely both genetic and infectious greatly strengthened and extended the prion concept. To date, 20 different mutations in the human PrP gene, all resulting in non-conservative substitutions, have been found either to be linked genetically to, or to segregate with, the inherited prion diseases (Figure 26.1). Yet, the transmissible prion particle is composed largely, if not exclusively, of an abnormal isoform of the prion protein designated PrP^{Sc} (Prusiner, 1991).

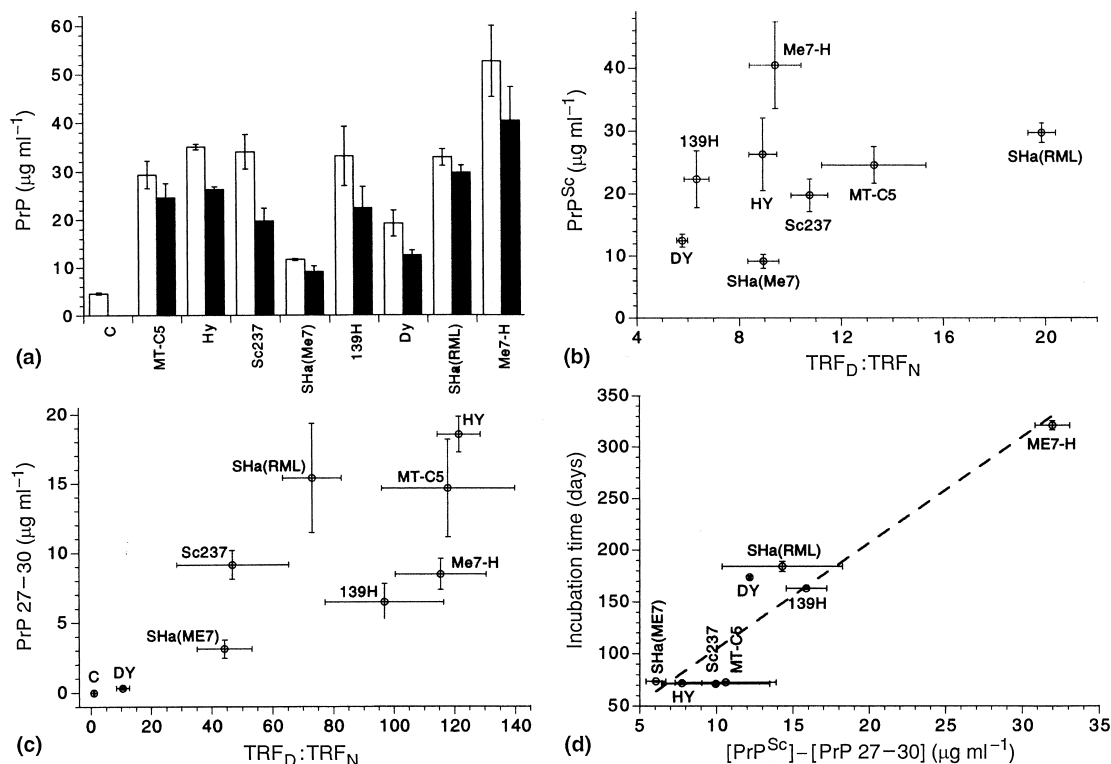

Figure 26.7 Eight prion strains distinguished by the conformation-dependent immunoassay. (a) Concentration of total PrP (■) and PrP^{Sc} (□). The columns and bars represent the average \pm SEM obtained from three different brains of LVG/LAK Syrian hamsters infected with different prion strains and measured in three independent experiments. (b) Ratio of antibody binding to denatured/native PrP and a function of concentration of PrP^{Sc} in the brains of Syrian hamsters infected with different prion strains. Concentration of PrP^{Sc} (formula 1) and the ratio of antibody binding to denatured/native PrP were measured by the conformation-dependent immunoassay. (c) Brain homogenates of Syrian hamsters inoculated with different scrapie strains and uninoculated controls, denoted C, were digested with $50 \mu\text{g ml}^{-1}$ proteinase K for 2 h at 37°C prior to the conformation-dependent immunoassay. (d) Incubation time plotted as a function of the concentration of the proteinase K-sensitive fraction of PrP^{Sc} ([PrP^{Sc}] - [PrP 27-30]). (Data from Safar *et al.*, 1998)

Aberrant PrP Metabolism

The hallmark of all prion diseases—whether sporadic, dominantly inherited or acquired by infection—is that they involve the aberrant metabolism and resulting accumulation of the prion protein (Table 26.1) (Prusiner, 1991). The conversion of PrP^C into PrP^{Sc} involves a conformation change whereby the α -helical content diminishes and the amount of β sheet increases (Pan *et al.*, 1993). These findings provide a reasonable mechanism to explain the conundrum presented by the three different manifestations of prion disease.

Understanding how PrP^C unfolds and refolds into PrP^{Sc} will be of paramount importance in

transferring advances in the prion diseases to studies of other degenerative illnesses. The mechanism by which PrP^{Sc} is formed must involve a templating process whereby existing PrP^{Sc} directs the refolding of PrP^C into a nascent PrP^{Sc} with the same conformation. Not only will a knowledge of PrP^{Sc} formation help in the rational design of drugs that interrupt the pathogenesis of prion diseases, but it may also open new approaches to deciphering the causes of and developing effective therapies for the more common neurodegenerative diseases, including AD, Parkinson's disease and amyotrophic lateral sclerosis (ALS). Indeed, the expanding list of prion diseases and their novel modes of transmission and pathogenesis (Table 26.1), as well as the unprecedented mechanisms of prion propagation and infor-

mation transfer (Table 26.5), indicate that much more attention to these fatal disorders of protein conformation is urgently needed.

But prions may have even wider implications than those noted for the common neurodegenerative diseases. If we think of prion diseases as disorders of protein conformation and do not require the diseases to be transmissible, then what we have learned from the study of prions may reach far beyond these common illnesses.

Conformational Diversity

The discovery that proteins may have multiple biologically active conformations may prove no less important than the implications of prions for diseases. How many different tertiary structures can PrP^{Sc} adopt? This query not only addresses the issue of the limits of prion diversity but also applies to proteins as they normally function within the cell or act to affect homeostasis in multicellular organisms. The expanding list of chaperones that assist the folding and unfolding of proteins promises much new knowledge about this process. For example, it is now clear that propeptases can carry their own chaperone activity, in which the *pro* portion of the protein functions as a chaperone in *cis* to guide the folding of the proteolytically active portion before it is cleaved (Shinde *et al.*, 1997). Such a mechanism might well feature in the maturation of polypeptide hormones. Interestingly, mutation of the chaperone portion of prosubtilisin resulted in the folding of a subtilisin protease with different properties than the one folded by the wt chaperone. Such chaperones have also been shown to work in *trans* (Shinde *et al.*, 1997). Besides transient metabolic regulation within the cell and hormonal regulation of multicellular organisms, it is not unreasonable to suggest that assembly of proteins into multimeric structures such as intermediate filaments might be controlled at least in part by alternative conformations of proteins. Such regulation of multimeric protein assemblies might occur either in the proteins that form the multimers or in the proteins that function to facilitate the assembly process. Additionally, apoptosis during development and throughout adult life might also be regulated, at least in part by alternative tertiary structures of proteins.

Future Studies

The wealth of data establishing the essential role of PrP in the transmission of prions and the pathogenesis of prion diseases has provoked consideration of how many biological processes are controlled by changes in protein conformation. The extreme radiation resistance of scrapie infectivity suggested that the pathogen causing this disease and related illnesses would be different from viruses, viroids and bacteria (Alper *et al.*, 1967). Indeed, an unprecedented mechanism of disease has been revealed whereby an aberrant conformational change in a protein is propagated. The future of this emerging area of biology should prove even more interesting and productive as many new discoveries emerge.

ACKNOWLEDGMENTS

I am indebted to F. Cohen, S. DeArmond and M. Scott for their help in summarizing these studies. This research was supported by grants from the National Institute of Aging and the National Institute of Neurologic Diseases and Stroke of the National Institutes of Health, the National Science Foundation, International Human Frontiers of Science Program and the American Health Assistance Foundation, as well as by gifts from the Sherman Fairchild Foundation, the Keck Foundation, the G. Harold and Leila Y. Mathers Foundation, the Bernard Osher Foundation, the John D. French Foundation, the Howard Hughes Medical Institute, R. J. Reynolds, National Medical Enterprises and Centeon.

REFERENCES

- Alper, T., Cramp, W.A., Haig, D.A. *et al.* (1967). Does the agent of scrapie replicate without nucleic acid? *Nature*, **214**, 764–766.
- Anderson, R.M., Donnelly, C.A., Ferguson, N.M. *et al.* (1996) Transmission dynamics and epidemiology of BSE in British cattle. *Nature*, **382**, 779–788.
- Austin, J. and Sakai, M. (1976) Disorder of glycogen and related molecules in the nervous system. In *Handbook of Clinical Neurology*, vol. 27 (eds P.J. Vinken and G.W. Bruyn). pp 169–219. American Elsevier, New York.
- Baker, H.F., Ridley, R.M. and Wells, G.A.H. (1993) Experimental transmission of BSE and scrapie to the common marmoset. *Veterinary Record*, **132**, 403–406.
- Bateman, D., Hilton, D., Love, S. *et al.* (1995) Sporadic Creutz-

- zfeldt-Jakob disease in a 18-year-old in the UK (letter). *Lancet*, **346**, 1155–1156.
- Bernoulli, C., Siegfried, J., Baumgartner, G. *et al.* (1977) Danger of accidental person to person transmission of Creutzfeldt-Jakob disease by surgery. *Lancet*, **i**, 478–479.
- Bessen, R.A. and Marsh, R.F. (1994) Distinct PrP properties suggest the molecular basis of strain variation in transmissible mink encephalopathy. *Journal of Virology*, **68**, 7859–7868.
- Bockman, J.M., Prusiner, S.B., Tateishi, J. *et al.* (1987) Immunoblotting of Creutzfeldt-Jakob disease prion proteins: host species-specific epitopes. *Annals of Neurology*, **21**, 589–595.
- Borchelt, D.R., Scott, M., Taraboulos, A. *et al.* (1990) Scrapie and cellular prion proteins differ in their kinetics of synthesis and topology in cultured cells. *Journal of Cell Biology*, **110**, 743–752.
- Britton, T.C., Al-Sarraj, S., Shaw, C. *et al.* (1995) Sporadic Creutzfeldt-Jakob disease in a 16-year-old in the UK (letter). *Lancet*, **346**, 1155.
- Brown, P., Rohwer, R.G., and Gajdusek, D.C. (1984) Sodium hydroxide decontamination of Creutzfeldt-Jakob disease virus. *New England Journal of Medicine*, **310**, 727.
- Brown, P., Gibbs, C.J. Jr., Rodgers-Johnson, P. *et al.* (1994) Human spongiform encephalopathy: the National Institutes of Health series of 300 cases of experimentally transmitted disease. *Annals of Neurology*, **35**, 513–529.
- Bruce, M.E. and Dickinson, A.G. (1987) Biological evidence that the scrapie agent has an independent genome. *Journal of General Virology*, **68**, 79–89.
- Bruce, M.E., McBride, P.A. and Farquhar, C.F. (1989) Precise targeting of the pathology of the sialoglycoprotein, PrP, and vacuolar degeneration in mouse scrapie. *Neuroscience Letters*, **102**, 1–6.
- Bruce, M.E., Will, R.G., Ironside, J.W. *et al.* (1997) Transmissions to mice indicate that 'new variant' CJD is caused by the BSE agent. *Nature*, **389**, 498–501.
- Büeler, H., Fischer, M., Lang, Y. *et al.* (1992) Normal development and behaviour of mice lacking the neuronal cell-surface PrP protein. *Nature*, **356**, 577–582.
- Büeler, H., Aguzzi, A., Sailer, A. *et al.* (1993) Mice devoid of PrP are resistant to scrapie. *Cell*, **73**, 1339–1347.
- Carlson, G.A., Ebeling, C., Yang, S.-L. *et al.* (1994) Prion isolate specified allotypic interactions between the cellular and scrapie prion proteins in congenic and transgenic mice. *Proceedings of the National Academy of Sciences of the USA*, **91**, 5690–5694.
- Carp, R.I., Meeker, H. and Sersen, E. (1997) Scrapie strains retain their distinctive characteristics following passages of homogenates from different brain regions and spleen. *Journal of General Virology*, **78**, 283–290.
- Cathala, F. and Baron, H. (1987) Clinical aspects of Creutzfeldt-Jakob disease. In *Prions—Novel Infectious Pathogens Causing Scrapie and Creutzfeldt-Jakob Disease* (eds S.B. Prusiner and M.P. McKinley), pp 467–509. Academic Press, Orlando.
- Caughey, B. and Raymond, G.J. (1991) The scrapie-associated form of PrP is made from a cell surface precursor that is both protease- and phospholipase-sensitive. *Journal of Biological Chemistry*, **266**, 18217–18223.
- Centers for Disease Control (1996) Surveillance for Creutzfeldt-Jakob disease—United States. *MMWR Morbidity and Mortality Weekly Report*, **45**, 665–668.
- Centers for Disease Control (1997) Creutzfeldt-Jakob disease associated with cadaveric dura mater grafts—Japan, January 1979–May 1996. *MMWR Morbidity and Mortality Weekly Report*, **46**, 1066–1069.
- Chandler, R.L. (1961) Encephalopathy in mice produced by inoculation with scrapie brain material. *Lancet*, **i**, 1378–1379.
- Chapman, J., Ben-Israel, J., Goldhammer, Y. *et al.* (1994) The risk of developing Creutzfeldt-Jakob disease in subjects with the PRNP gene codon 200 point mutation. *Neurology*, **44**, 1683–1686.
- Chazot, G., Broussolle, E., Lapras, C.I. *et al.* (1996) New variant of Creutzfeldt-Jakob disease in a 26-year-old French man. *Lancet*, **347**, 1181.
- Cochius, J.I., Mack, K., Burns, R.J. *et al.* (1990) Creutzfeldt-Jakob disease in a recipient of human pituitary-derived gonadotrophin. *Australian and New Zealand Journal of Medicine*, **20**, 592–593.
- Collinge, J., Sidle, K.C.L., Meads, J. *et al.* (1996) Molecular analysis of prion strain variation and the aetiology of 'new variant' CJD. *Nature*, **383**, 685–690.
- Cousens, S.N., Harries-Jones, R., Knight, R. *et al.* (1990) Geographical distribution of cases of Creutzfeldt-Jakob disease in England and Wales 1970–84. *Journal of Neurology, Neurosurgery and Psychiatry*, **53**, 459–465.
- Cousens, S.N., Vynnycky, E., Zeidler, M. *et al.* (1997) Predicting the CJD epidemic in humans. *Nature*, **385**, 197–198.
- DeArmond, S.J. and Prusiner, S.B. (1997) Prion diseases. In *Greenfield's Neuropathology*, 6th edn (eds P. Lantos and D. Graham), pp 235–280. Edward Arnold, London.
- DeArmond, S.J., Kretschmar, H.A., McKinley, M.P. *et al.* (1987a) Molecular pathology of prion diseases. In *Prions—Novel Infectious Pathogens Causing Scrapie and Creutzfeldt-Jakob Disease* (eds S.B. Prusiner and M.P. McKinley), pp 387–414. Academic Press, Orlando.
- DeArmond, S.J., Mobley, W.C., DeMott, D.L. *et al.* (1987b) Changes in the localization of brain prion proteins during scrapie infection. *Neurology*, **37**, 1271–1280.
- DeArmond, S.J., Sánchez, H., Yehiely, F. *et al.* (1997) Selective neuronal targeting in prion disease. *Neuron*, **19**, 1337–1348.
- Dickinson, A.G., Meikle, V.M.H. and Fraser, H. (1968) Identification of a gene which controls the incubation period of some strains of scrapie agent in mice. *Journal of Comparative Pathology*, **78**, 293–299.
- Dlouhy, S.R., Hsiao, K., Farlow, M.R. (1992) Linkage of the Indiana kindred of Gerstmann-Sträussler-Scheinker disease to the prion protein gene. *Nature Genetics*, **1**, 64–67.
- Doh-ura, K., Tateishi, J., Sasaki, H. *et al.* (1989) Pro- > Leu change at position 102 of prion protein is the most common but not the sole mutation related to Gerstmann-Sträussler syndrome. *Biochemical and Biophysical Research Communications*, **163**, 974–979.
- Donne, D.G., Viles, J.H., Groth, D. *et al.* (1997) Structure of the recombinant full-length hamster prion protein PrP(29–231): the N terminus is highly flexible. *Proceedings of the National Academy of Sciences of the USA*, **94**, 13452–13457.
- Duffy, P., Wolf, J., Collins, G. *et al.* (1974) Possible person to person transmission of Creutzfeldt-Jakob disease. *New England Journal of Medicine*, **290**, 692–693.
- Edenhofer, F., Rieger, R., Famulok, M. *et al.* (1996) Prion protein PrP^C interacts with molecular chaperones of the Hsp60 family. *Journal of Virology*, **70**, 4724–4728.

- Ehlers, B. and Diringer, H. (1984) Dextran sulphate 500 delays and prevents mouse scrapie by impairment of agent replication in spleen. *Journal of General Virology*, **65**, 1325–1330.
- Fradkin, J.E., Schonberger, L.B., Mills, J.L. *et al.* (1991) Creutzfeldt–Jakob disease in pituitary growth hormone recipients in the United States. *JAMA*, **265**, 880–884.
- Fraser, H. and Dickinson, A.G. (1968) The sequential development of the brain lesions of scrapie in three strains of mice. *Journal of Comparative Pathology*, **78**, 301–311.
- Fraser, H. and Dickinson, A.G. (1973) Scrapie in mice. Agent-strain differences in the distribution and intensity of grey matter vacuolation. *Journal of Comparative Pathology*, **83**, 29–40.
- Gabizon, R., McKinley, M.P., Groth, D. *et al.* (1988a) Immunoaffinity purification and neutralization of scrapie prion infectivity. *Proceedings of the National Academy of Sciences of the USA*, **85**, 6617–6621.
- Gabizon, R., McKinley, M.P., Groth, D.F. *et al.* (1988b) Properties of scrapie prion protein liposomes. *Journal of Biological Chemistry*, **263**, 4950–4955.
- Gabizon, R., Rosenmann, H., Meiner, Z. *et al.* (1993) Mutation and polymorphism of the prion protein gene in Libyan Jews with Creutzfeldt–Jakob disease (CJD). *American Journal of Human Genetics*, **53**, 828–835.
- Gabizon, R., Rosenman, H., Meiner, Z. *et al.* (1994) Mutation in codon 200 and polymorphism in codon 129 of the prion protein gene in Libyan Jews with Creutzfeldt–Jakob disease. *Philosophical Transactions of the Royal Society of London. Series B: Biological Sciences*, **343**, 385–390.
- Gabizon, R., Telling, G., Meiner, Z. (1996) Insoluble wild-type and protease-resistant mutant prion protein in brains of patients with inherited prion disease. *Nature Medicine*, **2**, 59–64.
- Gajdusek, D.C. (1977) Unconventional viruses and the origin and disappearance of kuru. *Science*, **197**, 943–960.
- Gajdusek, D.C., Gibbs, C.J., Jr and Alpers, M. (1966) Experimental transmission of a kuru-like syndrome to chimpanzees. *Nature*, **209**, 794–796.
- Gajdusek, D.C., Gibbs, C.J., Jr, Asher, D.M. *et al.* (1977) Precautions in medical care, and in handling materials from patients with transmissible virus dementia (Creutzfeldt–Jakob disease). *New England Journal of Medicine*, **297**, 1253–1258.
- Gerstmann, J., Strüssler, E. and Scheinker, I. (1936) Über eine eigenartige hereditär-familiäre Erkrankung des Zentralnervensystems zugleich ein Beitrag zur frage des vorzeitigen lokalen Alterns. *Zeitschrift Neurologie*, **154**, 736–762.
- Ghetti, B., Tagliavini, F., Masters, C.L. *et al.* (1989) Gerstmann–Strüssler–Scheinker disease. II. Neurofibrillary tangles and plaques with PrP-amyloid coexist in an affected family. *Neurology*, **39**, 1453–1461.
- Gibbs, C.J. Jr, Gajdusek, D.C., Asher, D.M. *et al.* (1968) Creutzfeldt–Jakob disease (spongiform encephalopathy): transmission to the chimpanzee. *Science*, **161**, 388–389.
- Goldfarb, L.G., Mitrova, E., Brown, P. *et al.* (1990) Mutation in codon 200 of scrapie amyloid protein gene in two clusters of Creutzfeldt–Jakob disease in Slovakia. *Lancet*, **336**, 514–515.
- Goldfarb, L.G., Petersen, R.B., Tabaton, M. *et al.* (1992) Fatal familial insomnia and familial Creutzfeldt–Jakob disease: disease phenotype determined by a DNA polymorphism. *Science*, **258**, 806–808.
- Goldmann, W., Hunter, N., Foster, J.D. (1990a) Two alleles of a neural protein gene linked to scrapie in sheep. *Proceedings of the National Academy of Sciences of the USA*, **87**, 2476–2480.
- Goldmann, W., Hunter, N., Manson, J. *et al.* (1990b) The PrP gene of the sheep, a natural host of scrapie. *Proceedings of the VIIIth International Congress of Virology*, Berlin, Aug. 26–31 284.
- Gomori, A.J., Partnow, M.J., Horoupian, D.S. *et al.* (1973) The ataxic form of Creutzfeldt–Jakob disease. *Archives of Neurology*, **29**, 318–323.
- Gordon, W.S. (1946) Advances in veterinary research. *Veterinary Research*, **58**, 516–520.
- Gorman, D.G., Benson, D.F., Vogel, D.G. *et al.* (1992) Creutzfeldt–Jakob disease in a pathologist. *Neurology*, **42**, 463.
- Gorodinsky, A. and Harris, D.A. (1995) Glycolipid-anchored proteins in neuroblastoma cells form detergent-resistant complexes without caveolin. *Journal of Cell Biology*, **129**, 619–627.
- Hadlow, W.J. (1959) Scrapie and kuru. *Lancet*, **2**, 289–290.
- Hill, A.F., Desbruslais, M., Joiner, S. *et al.* (1997) The same prion strain causes vCJD and BSE. *Nature*, **389**, 448–450.
- Holman, R.C., Khan, A.S., Belay, E.D. *et al.* (1996) Creutzfeldt–Jakob disease in the United States, 1979–1994: using national mortality data to assess the possible occurrence of variant cases. *Emerging Infectious Diseases*, **2**, 333–337.
- Hornabrook, R.W. (1968) Kuru—a subacute cerebellar degeneration: the natural history and clinical features. *Brain*, **91**, 53–74.
- Hsiao, K., Baker, H.F., Crow, T.J. *et al.* (1989) Linkage of a prion protein missense variant to Gerstmann–Sträussler syndrome. *Nature*, **338**, 342–345.
- Hsiao, K.K., Cass, C., and Schellenberg, G.D. (1991) A prion protein variant in a family with the telencephalic form of Gerstmann–Sträussler–Scheinker syndrome. *Neurology*, **41**, 681–684.
- Huang, Z., Prusiner, S.B. and Cohen, F.E. (1995) Scrapie prions: a three-dimensional model of an infectious fragment. *Folding and Design*, **1**, 13–19.
- Hudson, A.J., Farrell, M.A., Kalnins, R. *et al.* (1983) Gerstmann–Sträussler–Scheinker disease with coincidental familial onset. *Annals of Neurology*, **14**, 670–678.
- Hunter, N., Foster, J.D., Dickinson, A.G. *et al.* (1989) Linkage of the gene for the scrapie-associated fibril protein (PrP) to the Sip gene in Cheviot sheep. *Veterinary Record*, **124**, 364–366.
- Hunter, N., Goldmann, W., Smith, G. *et al.* (1994) Frequencies of PrP gene variants in healthy cattle and cattle with BSE in Scotland. *Veterinary Record*, **135**, 400–403.
- Hunter, N., Moore, L., Hosie, B.D. *et al.* (1997) Association between natural scrapie and PrP genotype in a flock of Suffolk sheep in Scotland. *Veterinary Record*, **140**, 59–63.
- Ironside, J.W. (1997) The new variant form of Creutzfeldt–Jakob disease: a novel prion protein amyloid disorder (editorial). *Amyloid: International Journal of Experimental and Clinical Investigation*, **4**, 66–69.
- James, T.L., Liu, H., Ulyanov, N.B. *et al.* (1997) Solution structure of a 142-residue recombinant prion protein corresponding to the infectious fragment of the scrapie isoform. *Proceedings of the National Academy of Sciences of the USA*, **94**, 10086–10091.
- Jarrett, J.T. and Lansbury, P.T. Jr (1993) Seeding ‘one-dimensional crystallization’ of amyloid: a pathogenic mechanism in Alzheimer’s disease and scrapie? *Cell*, **73**, 1055–1058.
- Johnson, R.T. and Gibbs, C.J. Jr (1998) Creutzfeldt–Jakob disease and related transmissible spongiform encephalopathies.

- New England Journal of Medicine*, **339**, 1994–2004.
- Kaneko, K., Zulianello, L., Scott, M. *et al.* (1997) Evidence for protein X binding to a discontinuous epitope on the cellular prion protein during scrapie prion propagation. *Proceedings of the National Academy of Sciences of the USA*, **94**, 10069–10074.
- Kenward, N., Hope, J., Landon, M. *et al.* (1994) Expression of polyubiquitin and heat-shock protein 70 genes increases in the later stages of disease progression in scrapie-infected mouse brain. *Journal of Neurochemistry*, **62**, 1870–1877.
- Kirschbaum, W.R. (1968) *Jakob–Creutzfeldt Disease*. Elsevier, Amsterdam.
- Klatzo, I., Gajdusek, D.C. and Zigas, V. (1959) Pathology of kuru. *Laboratory Investigation*, **8**, 799–847.
- Kocisko, D.A., Come, J.H., Priola, S.A. *et al.* (1994) Cell-free formation of protease-resistant prion protein. *Nature*, **370**, 471–474.
- Kurschner, C. and Morgan, J.I. (1996) Analysis of interaction sites in homo- and heteromeric complexes containing Bcl-2 family members and the cellular prion protein. *Molecular Brain Research*, **37**, 249–258.
- Lehmann, S. and Harris, D.A. (1996) Two mutant prion proteins expressed in cultured cells acquire biochemical properties reminiscent of the scrapie isoform. *Proceedings of the National Academy of Sciences of the USA*, **93**, 5610–5614.
- Levy, R.M., Bredeken, D.E. and Rosenblum, M.L. (1985) Neurological manifestations of the acquired immunodeficiency syndrome (AIDS): experience at UCSF and review of the literature. *Journal of Neurosurgery*, **62**, 475–495.
- Manson, J.C., Clarke, A.R., Hooper, M.L. *et al.* (1994) 129/Ola mice carrying a null mutation in PrP that abolishes mRNA production are developmentally normal. *Molecular Neurobiology*, **8**, 121–127.
- Manuelidis, E., Kim, J., Angelo, J. *et al.* (1976) Serial propagation of Creutzfeldt–Jakob disease in guinea pigs. *Proceedings of the National Academy of Sciences of the USA*, **73**, 223–227.
- Manuelidis, L. (1997) Decontamination of Creutzfeldt–Jakob disease and other transmissible agents. *Journal of Neurovirology*, **3**, 62–65.
- Marsh, R.F., Sipe, J.C., Morse, S.S. *et al.* (1976) Transmissible mink encephalopathy: reduced spongiform degeneration in aged mink of the Chediak–Higashi genotype. *Laboratory Investigation*, **34**, 381–386.
- Masters, C.L., Harris, J.O., Gajdusek, D.C. *et al.* (1978) Creutzfeldt–Jakob disease: patterns of worldwide occurrence and the significance of familial and sporadic clustering. *Annals of Neurology*, **5**, 177–188.
- Masters, C.L., Gajdusek, D.C. and Gibbs, C.J. Jr (1981) Creutzfeldt–Jakob disease virus isolations from the Gerstmann–Sträussler syndrome. *Brain*, **104**, 559–588.
- Mastrianni, J.A., Curtis, M.T., Oberholtzer, J.C. *et al.* (1995) Prion disease (PrP-A117V) presenting with ataxia instead of dementia. *Neurology*, **45**, 2042–2050.
- Mastrianni, J., Nixon, F., Layzer, R. *et al.* (1997) Fatal sporadic insomnia: fatal familial insomnia phenotype without a mutation of the prion protein gene. *Neurology*, **48** (suppl.), A296.
- Masullo, C., Macchi, G., Xi, Y.G. *et al.* (1992) Failure to ameliorate Creutzfeldt–Jakob disease with amphotericin B therapy. *Journal of Infectious Diseases*, **165**, 784–785.
- Monari, L., Chen, S.G., Brown, P. *et al.* (1994) Fatal familial insomnia and familial Creutzfeldt–Jakob disease: different prion proteins determined by a DNA polymorphism. *Proceedings of the National Academy of Sciences of the USA*, **91**, 2839–2842.
- Moore, R.C., Hope, J., McBride, P.A. *et al.* (1998) Mice with gene targeted prion protein alterations show that *Prn-p*, *Sinc* and *Prni* are congruent. *Nature Genetics*, **18**, 118–125.
- Nathanson, N., Wilesmith, J. and Griot, C. (1997) Bovine spongiform encephalopathy (BSE): cause and consequences of a common source epidemic. *American Journal of Epidemiology*, **145**, 959–969.
- Nevin, S., McMenemy, W.H., Behrman, S. *et al.* (1960) Subacute spongiform encephalopathy—a subacute form of encephalopathy attributable to vascular dysfunction (spongiform cerebral atrophy). *Brain*, **83**, 519–564.
- Palmer, M.S., Dryden, A.J., Hughes, J.T. *et al.* (1991) Homozygous prion protein genotype predisposes to sporadic Creutzfeldt–Jakob disease. *Nature*, **352**, 340–342.
- Pan, K.-M., Baldwin, M., Nguyen, J. *et al.* (1993) Conversion of α -helices into β -sheets features in the formation of the scrapie prion proteins. *Proceedings of the National Academy of Sciences of the USA*, **90**, 10962–10966.
- Parchi, P., Castellani, R., Capellari, S. *et al.* (1996) Molecular basis of phenotypic variability in sporadic Creutzfeldt–Jakob disease. *Annals of Neurology*, **39**, 767–778.
- Parry, H.B. (1983) *Scrapie Disease in Sheep*. Academic Press, New York.
- Pattison, I.H. (1965) Experiments with scrapie with special reference to the nature of the agent and the pathology of the disease. In *Slow, Latent and Temperate Virus Infections*, NINDB Monograph 2 (eds D.C. Gajdusek, C.J. Gibbs Jr and M.P. Alpers). pp 249–257. US Government Printing, Washington DC.
- Pattison, I.H. (1988) Fifty years with scrapie: a personal reminiscence. *Veterinary Record*, **123**, 661–666.
- Petersen, R.B., Tabaton, M., Berg, L. *et al.* (1992) Analysis of the prion protein gene in thalamic dementia. *Neurology*, **42**, 1859–1863.
- PHS (1997) *Report on Human Growth Hormone and Creutzfeldt–Jakob Disease*. Public Health Service Interagency Coordinating Committee. US Government Printing, Washington DC.
- Poulter, M., Baker, H.F., Frith, C.D. *et al.* (1992) Inherited prion disease with 144 base pair gene insertion. 1. Genealogical and molecular studies. *Brain*, **115**, 675–685.
- Prusiner, S.B. (1982) Novel proteinaceous infectious particles cause scrapie. *Science*, **216**, 136–144.
- Prusiner, S.B. (1991) Molecular biology of prion diseases. *Science*, **252**, 1515–1522.
- Prusiner, S.B. (1998) Prions. *Proceedings of the National Academy of Sciences of the USA*, **95**, 13363–13383.
- Prusiner, S.B., Groth, D.F., Cochran, S.P. *et al.* (1980) Molecular properties, partial purification, and assay by incubation period measurements of the hamster scrapie agent. *Biochemistry*, **21**, 4883–4891.
- Prusiner, S.B., Gajdusek, D.C. and Alpers, M.P. (1982) Kuru with incubation periods exceeding two decades. *Annals of Neurology*, **12**, 1–9.
- Prusiner, S.B., McKinley, M.P., Bowman, K.A. *et al.* (1983) Scrapie prions aggregate to form amyloid-like birefringent rods. *Cell*, **35**, 349–358.
- Prusiner, S.B., McKinley, M.P., Bolton, D.C. *et al.* (1984) Prions:

- methods for assay, purification and characterization. In *Methods in Virology* (eds K. Maramorosch and H. Koprowski), pp 293–345. Academic Press, New York.
- Prusiner, S.B., Cochran, S.P. and Alpers, M.P. (1985) Transmission of scrapie in hamsters. *Journal of Infectious Diseases*, **152**, 971–978.
- Prusiner, S.B., Scott, M., Foster, D. *et al.* (1990) Transgenic studies implicate interactions between homologous PrP isoforms in scrapie prion replication. *Cell*, **63**, 673–686.
- Prusiner, S.B., Groth, D., Serban, A. *et al.* (1993) Ablation of the prion protein (PrP) gene in mice prevents scrapie and facilitates production of anti-PrP antibodies. *Proceedings of the National Academy of Sciences of the USA*, **90**, 10608–10612.
- Richardson, E.P.J. and Masters, C.L. (1995) The nosology of Creutzfeldt–Jakob disease and conditions related to the accumulation of PrP^{CJD} in the nervous system. *Brain Pathology*, **5**, 33–41.
- Richardson, J.H. and Barkley, W.E. (1988) *Biosafety in Microbiological and Biomedical Laboratories*. US Department of Health and Human Services, Public Health Service, Centers for Disease Control and National Institutes of Health. US Government Printing, Washington, DC.
- Ridley, R.M. and Baker, H.F. (1996) To what extent is strain variation evidence for an independent genome in the agent of the transmissible spongiform encephalopathies? *Neurodegeneration*, **5**, 219–231.
- Roberts, G.W., Lofthouse, R., Allsop, D. *et al.* (1988) CNS amyloid proteins in neurodegenerative diseases. *Neurology*, **38**, 1534–1540.
- Robinson, M.M., Hadlow, W.J., Knowles, D.P. *et al.* (1995) Experimental infection of cattle with the agents of transmissible mink encephalopathy and scrapie. *Journal of Comparative Pathology*, **113**, 241–251.
- Roos, R., Gajdusek, D.C. and Gibbs, C.J. Jr (1973) The clinical characteristics of transmissible Creutzfeldt–Jakob disease. *Brain*, **96**, 1–20.
- Rosenthal, N.P., Keeseey, J., Crandall, B. *et al.* (1976) Familial neurological disease associated with spongiform encephalopathy. *Archives of Neurology*, **33**, 252–259.
- Safar, J., Wille, H., Itri, V. *et al.* (1998) Eight prion strains have PrP^{Sc} molecules with different conformations. *Nature Medicine*, **4**, 1157–1165.
- Sakaguchi, S., Katamine, S., Nishida, N. *et al.* (1996) Loss of cerebellar Purkinje cells in aged mice homozygous for a disrupted PrP gene. *Nature*, **380**, 528–531.
- Salazar, A.M., Masters, C.L., Gajdusek, D.C. *et al.* (1983) Syndromes of amyotrophic lateral sclerosis and dementia: relation to transmissible Creutzfeldt–Jakob disease. *Annals of Neurology*, **14**, 17–26.
- Scott, M.R., Groth, D., Tatzelt, J. *et al.* (1997a) Propagation of prion strains through specific conformers of the prion protein. *Journal of Virology*, **71**, 9032–9044.
- Scott, M.R., Safar, J., Telling, G. *et al.* (1997b) Identification of a prion protein epitope modulating transmission of bovine spongiform encephalopathy prions to transgenic mice. *Proceedings of the National Academy of Sciences of the USA*, **94**, 14279–14284.
- Serban, D., Taraboulos, A., DeArmond, S.J. *et al.* (1990) Rapid detection of Creutzfeldt–Jakob disease and scrapie prion proteins. *Neurology*, **40**, 110–117.
- Shibuya, S., Higuchi, J., Shin, R.-W. *et al.* (1998a) Codon 219 Lys allele of PRNP is not found in sporadic Creutzfeldt–Jakob disease. *Annals of Neurology*, **43**, 826–828.
- Shibuya, S., Higuchi, J., Shin, R.-W. *et al.* (1998b) Protective prion protein polymorphisms against sporadic Creutzfeldt–Jakob disease. *Lancet*, **351**, 419.
- Shinde, U.P., Liu, J.J. and Inouye, M. (1997) Protein memory through altered folding mediated by intramolecular chaperones. *Nature*, **389**, 520–522.
- Somerville, R.A., Chong, A., Mulqueen, O.U. *et al.* (1997) Biochemical typing of scrapie strains. *Nature*, **386**, 564.
- Stekel, D.J., Nowak, M.A. and Southwood, T.R.E. (1996) Prediction of future BSE spread. *Nature*, **381**, 119.
- Tagliavini, F., Prelli, F., Porro, M. *et al.* (1994) Amyloid fibrils in Gerstmann–Sträussler–Scheinker disease (Indiana and Swedish kindreds) express only PrP peptides encoded by the mutant allele. *Cell*, **79**, 695–703.
- Tange, R.A., Troost, D. and Limburg, M. (1989) Progressive fatal dementia (Creutzfeldt–Jakob disease) in a patient who received homograft tissue for tympanic membrane closure. *European Archives of Otorhinolaryngology*, **247**, 199–201.
- Taraboulos, A., Jendroska, K., Serban, D. *et al.* (1992) Regional mapping of prion proteins in brains. *Proceedings of the National Academy of Sciences of the USA*, **89**, 7620–7624.
- Taraboulos, A., Scott, M., Semenov, A. *et al.* (1995) Cholesterol depletion and modification of COOH-terminal targeting sequence of the prion protein inhibits formation of the scrapie isoform. *Journal of Cell Biology*, **129**, 121–132.
- Tateishi, J. and Kitamoto, T. (1993) Developments in diagnosis for prion diseases. *British Medical Bulletin*, **49**, 971–979.
- Tateishi, J., Kitamoto, T., Doh-ura, K. *et al.* (1990) Immunohistochemical, molecular genetic, and transmission studies on a case of Gerstmann–Sträussler–Scheinker syndrome. *Neurology*, **40**, 1578–1581.
- Tateishi, J., Kitamoto, T., Hoque, M.Z. *et al.* (1996) Experimental transmission of Creutzfeldt–Jakob disease and related diseases to rodents. *Neurology*, **46**, 532–537.
- Tatzelt, J., Zuo, J., Voellmy, R. *et al.* (1995) Scrapie prions selectively modify the stress response in neuroblastoma cells. *Proceedings of the National Academy of Sciences of the USA*, **92**, 2944–2948.
- Taylor, D.M., Dickinson, A.G., Fraser, H. *et al.* (1985) Preparation of growth hormone free from contamination with unconventional slow viruses. *Lancet*, **ii**, 260–262.
- Taylor, D.M., Woodgate, S.L., Fleetwood, A.J. *et al.* (1997) Effect of rendering procedures on the scrapie agent. *Veterinary Record*, **141**, 643–649.
- Telling, G.C., Scott, M., Mastrianni, J. *et al.* (1995) Prion propagation in mice expressing human and chimeric PrP transgenes implicates the interaction of cellular PrP with another protein. *Cell*, **83**, 79–90.
- Telling, G.C., Haga, T., Torchia, M. *et al.* (1996a) Interactions between wild-type and mutant prion proteins modulate neurodegeneration in transgenic mice. *Genes and Development*, **10**, 1736–1750.
- Telling, G.C., Parchi, P., DeArmond, S.J. *et al.* (1996b) Evidence for the conformation of the pathologic isoform of the prion protein enciphering and propagating prion diversity. *Science*, **274**, 2079–2082.
- Terzano, M.G., Montanari, E., Calzetti, S. *et al.* (1983) The effect of amantadine on arousal and EEG patterns in Creutzfeldt–Jakob disease. *Archives of Neurology*, **40**, 555–559.

- Weiss, R. (1997) Study of 'mad cow' disease challenges prevailing theory. *International Herald Tribune*, January 18–19, 2.
- Weissmann, C. (1991) A 'unified theory' of prion propagation. *Nature*, **352**, 679–683.
- Westaway, D., Zuliani, V., Cooper, C.M. *et al.* (1994) Homozygosity for prion protein alleles encoding glutamine-171 renders sheep susceptible to natural scrapie. *Genes and Development*, **8**, 959–969.
- Wickner, R.B. (1997) A new prion controls fungal cell fusion incompatibility (commentary). *Proceedings of the National Academy of Sciences of the USA*, **94**, 10012–10014.
- Wilesmith, J.W., Ryan, J.B.M. and Atkinson, M.J. (1991) Bovine spongiform encephalopathy: epidemiologic studies on the origin. *Veterinary Record*, **128**, 199–203.
- Will, R.G. and Matthews, W.B. (1982) Evidence for case-to-case transmission of Creutzfeldt–Jakob disease. *Journal of Neurology, Neurosurgery and Psychiatry*, **45**, 235–238.
- Will, R.G., Ironside, J.W., Zeidler, M. *et al.* (1996) A new variant of Creutzfeldt–Jakob disease in the UK. *Lancet*, **347**, 921–925.
- Worthington, M. (1972) Interferon system in mice infected with the scrapie agent. *Infection and Immunity*, **6**, 643–645.
- Zerr, I., Bodemer, M., Gefeller, O. *et al.* (1998) Detection of 14-3-3 protein in the cerebrospinal fluid supports the diagnosis of Creutzfeldt–Jakob disease. *Annals of Neurology*, **43**, 32–40.

Index

Note: page numbers in *italics* refer to figures and tables

- abortion
 - B19 virus* 652–3
 - filoviruses 579
 - Lassa fever 567
 - mumps 424
 - Rift Valley fever 533
 - spontaneous with maternal rubella 400
 - acquired immune deficiency syndrome (AIDS) 12, 661
 - acyclovir-resistant VZV 73
 - adenoviruses 248, 316, 322
 - anogenital squamous carcinoma 677
 - Aspergillus* 674
 - astrovirus 248
 - Burkitt's lymphoma 138
 - candidiasis 674
 - case definition 672
 - CD8+ cells 670
 - clinical disease 670
 - Cryptococcus neoformans* 674
 - Cytomegalovirus* 92, 94, 106, 109–10, 111, 112
 - diarrhoea 675
 - human 155
 - pneumonitis 674
 - dementia 670
 - diarrhoeal disease 248
 - EBV 138
 - encephalitis 155
 - epidemic 663
 - HAART 112
 - HCMV 155
 - herpes simplex virus (HSV) 19, 673, 674–5
 - herpesvirus multiple infections 155
 - herpetic retinal necrosis 65
 - HHV-6 and HHV-7 141, 148, 153, 160
 - history 662
 - HSV-8 19
 - Kaposi's sarcoma 175, 181, 182, 183, 673, 675–7
 - KSHV distribution 180–1
 - management 670
 - measles vaccination 383
 - Mycobacterium avium* 674, 675
 - Mycobacterium intracellulare* 674, 675
 - Mycobacterium tuberculosis* 673
 - non-Hodgkin's lymphoma 677
 - opportunistic infections 673–5
 - oral lesions 124, 138, 673
 - PML 636, 641, 674
 - incidence 638
 - Pneumocystis carinii* pneumonia 673–4
 - progression markers 155
 - quantitative detection methods 11
 - retinitis 155
 - SRSVs 245
 - symptomatic disease 673
 - Toxoplasma gondii* 673, 674
 - Varicella zoster virus* 675
 - zoster 66
 - see also HIV infection; human immunodeficiency virus (HIV)
- acyclovir
 - CMV 108, 109
 - HSV 40–1, 43, 44
 - mode of action 40, 42
 - varicella 69–70, 73
 - VZV prophylaxis 73
 - Adenoviridae* 235
 - adenovirus death protein (ADP) 310
 - adenoviruses 307
 - acute haemorrhagic cystitis 320
 - Ad3 315–16
 - Ad7 315–16
 - agglutination patterns 325
 - AIDS 248, 316, 322
 - antigens 324, 325
 - bone marrow transplantation 316, 321
 - capsid 307, 308, 313
 - capsomers 307–8, 313
 - cell lines 323
 - classification 310, 311, 312
 - clinical syndromes 318–22
 - CNS infection 321
 - coeliac disease 321
 - conjunctivitis 316, 317
 - cysteine protease 309
 - cytopathic effect 322, 323
 - disseminated disease 326
 - DNA homology 310
 - DNA homology cluster
 - B:1 315–16
 - B:2 316
 - DNA hybridization techniques 324
 - DNA restriction enzyme analysis 315, 324
 - DNA restriction fragments 310, 312, 313
 - early transcription regions 309
 - enteric 235, 236, 241–2
 - epidemiology 313–18
 - evolutionary variant 312
 - eye infections 316, 317, 319–20, 325
 - fibres 307, 308
 - gastrointestinal infections 315, 317–18, 319, 320–1
 - gene therapy vectors 326
 - genetic variability 310, 312
 - genome type 312
 - genomic cluster 312
 - gluten intolerance 321
 - glycoproteins 308, 309
 - hexons 324
 - hyperlucent lung disease 319
 - identification 307, 323–4
 - immunocompromised patients 317, 321–2
 - immunofluorescence 2
 - infection prevention 325–6
 - intranuclear inclusion 313, 314
 - intussusception 321
 - isolate typing 324–5
 - keratoconjunctivitis 317, 320, 325
 - lactose intolerance 321
 - laryngotracheobronchitis 318
 - oncogenicity 310
 - pathogenesis 313
 - penton bases 307–8, 313
 - pentons 323
 - pertussis syndrome 319
 - pharyngoconjunctival fever 317, 319–20

- adenoviruses (*cont.*)
 pneumonia 318–19, 325
 polypeptides 308, 309–10
 protein synthesis 309
 recombinant 312
 renal transplantation 320, 321–2
 replication 309–10, 323
 respiratory disease 313–14, 315, 316,
 317, 318–19, 325–6
 acute 319
 Reye's syndrome 264
 serology 323–4, 324–5
 serotypes 307, 308, 312
 sexual transmission 317
 solid-phase immune electron
 microscopy 325
 specimen collection 322–3
 strain 312
 structure 307–9
 subgenera 307, 310, 311, 312, 314–18
 subgenus A 314–15
 subgenus B 315–16
 subgenus C 316–17
 subgenus D 317
 subgenus E 317
 subgenus F 317–18
 taxonomic terminology 312
 vaccines 325
 vectors 326
 virus isolation 1, 322–4
- adrenatitis, CMV 94
- adult T cell leukaemia/lymphoma
 (ATLL) 661, 695
 breast-feeding 708
 cells 704, 705
 HLA types 707
 HTLV-I association 703
 IL-2R expression 705–6
 immune suppression 707
 mother-to-child transmission 708
 pathogenesis 705–6
Pneumocystis carinii pneumonia
 prophylaxis 707
Tax gene 698
 treatment 707
- Aedes* mosquito 471, 472
Chikungunya virus vector 474, 475
 control strategies 496
Dengue virus
 hosts 498, 499
 isolation 501
 transmission 485
 vector eradication 502
Powassan virus vector 512
 Rift Valley fever vectors 530
Wesselsbron virus 496
 yellow fever
 transmission 492
 vectors 493, 494–5, 496
- AIDS *see* acquired immune deficiency
 syndrome
- Aino virus* 519, 527–8
Akabane virus 519, 527–8
 alanine aminotransferase 188–9, 225, 226
Alanquer virus 529
 alcohol consumption, HCV 224, 225
 alcoholism, secondary bacterial
 pneumonia in influenza 264
Alphaherpesvirinae 19, 20, 23
Alphavirus 467
 alphaviruses 467
 antigenic properties 468–9
 biochemical/biophysical properties 468
 capsid (C) protein 468
 disease spectrum 469
 encephalitis 477–82
 envelope (E) glycoproteins 468
 expression vectors 467
 fever 470–7
 genotypic properties 468–9
 glycoproteins 467
 hosts 467
 infection diagnosis 470
 management 470
 morphology 467, 468
 mosquito bite protection 470
 non-structural proteins (NSPs) 468
 polyarthritis 470–7
 prevention 470
 recombinant vaccines 467
 replication 468
 transmission 467
 vaccine 470, 473, 476
 vector control 470
- Alzheimer's disease
 amyloid plaques 713
 sporadic Creutzfeldt–Jakob disease 717
- aminopeptidase N (APN) 349, 350
- amyloid plaques
 Creutzfeldt–Jakob disease *xxiv*, 731
 Gerstmann–Sträussler–Scheinker
 disease *xxiv*, 728–9, 731–2
 kuru 731, 732
 prion diseases *xxiv*, 713, 714, 729
 PrP 713, 714
 immunostaining 721
 new variant CJD 724
- anaemia
 dyshaemopoietic 652
see also haemolytic anaemia
- Andes virus* 545
- anogenital squamous carcinoma,
 HIV/AIDS 677
- Anopheles* mosquito
 alphavirus vector 476
Bunyaviridae vector 519
Powassan virus vector 512
- Anopheles* serogroup A 518, 524
- anti-B19 IgG 655–6
 anti-B19 IgM 655
 anti-HBc 206
 anti-HBe 209, 210
- anti-HBs 206
 vaccine-induced 211
 anti-HD IgM 220
 antibody avidity tests 5
 antigen detection 2–3
 antigenic drift, *Influenza virus* 260–1
 antigenic shift, *Influenza virus* 258–60
 antiretroviral therapy, HIV 667
 antivaccinia γ -globulin 460
 antiviral therapy
 molecular assay monitoring 12–13
 VZV resistance 72–3
- Apeu virus* 518, 524–5
- aplastic crisis
B19 virus 646, 647, 649, 652, 653
 haemolytic anaemia 646, 647
 sickle cell anaemia 646
- apnoea, respiratory syncytial virus 300
- apoptosis
 HIV infection 667
 protein alternative tertiary structures
 742
- arboviruses 467, 486
- arenaviruses 551
 ambisense coding 556
 antibodies 559, 559–60
 antigenic relationships 557–8
 antigen–antibody complex 558
 deposition 561
 cell-mediated immunity 559, 560
 chemical composition 554–6
 complement fixation test 557
 cytopathic effect (CPE) 557
 distribution 552–3
 emerging infections 569
 filamentous strands 553
 glycoprotein precursor polypeptide
 (GPC) 554, 555
 glycoprotein species 555
 immune response 558–9
 infected cells 553
 infection diagnosis 556–7
 infection pathology 560–9
 interferon induction 558–9
 L RNA strand 556
 mRNA 556
 natural history 551–3
 nomenclature 551–3
 nucleic acid 555–6
 nucleocapsid-associated (N) protein
 555
 persistent infection 559–60
 properties 551–6
 replication 553, 556, 558
 S strand 555–6
 ultrastructure 553, 554
 Z protein 555
- argasid ticks, *Bunyaviridae* vectors 519
- Argentinian haemorrhagic fever
 clinical features 562–3
 diagnosis 562

- endemic zone 563
 epidemiology 563
 pathogenesis 560–1
 pathology 562–3
 prophylaxis 564
 therapy 563–4
 arthritis, varicella 62
 arthropathy, *B19 virus* 651
 aspartic aminotransferase 188–9, 226
Aspergillus, AIDS 674
 asthma exacerbation by rhinoviruses 335, 337
 astrocytic gliosis 729
 CJD xxiv, 731
Astroviridae 235
 astrovirus 235, 236, 236, 246–7
 AIDS 248
 classification 246
 diagnosis 247
 epidemiology 247
 genome 246
 pathogenesis 246
 replication 246
 species specificity 247
 structure 246
 transmission 247
 treatment 247
 athymic aplasia, congenital 29
 atopy, respiratory syncytial virus 300–1
 aural herpes 65
 aural zoster 64
Avian infectious bronchitis virus (IBV) 347

B19 virus 645
 anti-B19 IgG 655–6
 anti-B19 IgM 655
 aplastic crisis 646, 647, 649, 652, 653
 arthropathy 651
 blood products 650
 case-to-case intervals 649
 cell receptor 648
 cell tropism 648–9
 clinical features 650–3
 cycles of incidence 649
 detection 654
 distribution 652
 DNA 646
 detection 648
 epidemiology 649–50
 erythema infectiosum xx, 647, 648, 650–1
 erythrocyte 652
 precursor 649
 fetal loss 652–3
 genome 647
 organization 646
 giant pronormoblasts 649
 globoside 648–9
 haemolytic anaemia 651
 haemophiliacs 650
 human immunoglobulin treatment 656
 hydrops fetalis 647, 653, 655
 IgM 648
 immunocompromised patients 653
 in situ hybridization 654
 joint involvement 651
 laboratory diagnosis 653–6
 maternal infection 654
 megakaryocytopoiesis inhibition 649
 minor illness 650
 non-structural (NS) protein 646
 normoblasts 649
 P antigen 648–9
 pathogenesis 647–9
 PCR techniques 654
 pregnancy 652–3, 654
 prevention 656
 promoter sites 646
 proteins 646–7
 purpuric rash 651
 rash illness 650–1, 655
 respiratory tract infection 647–8, 650
 RNA transcripts 646
 seasonality 649
 self-assembling capsids 656
 serology 5
 sickle cell anaemia 652
 specific antibody detection 654–6
 specimen collection 653–4
 structural (VP) proteins 646–7
 structure 646
 transmission 649–50
 treatment 656
 vaccination 656
 variation 647
 viraemia 648
 B cell lymphoma, abdominal cavity 19
 B cells
 EBV-infected 126, 127, 132, 136, 137
 immortalization 123, 132
 infectious mononucleosis 125, 129
 B virus 20–1
Babanki virus 470
Bangui virus 546, 547
Barmah Forest virus 469, 473–4
 glomerulonephritis 474
Batai virus 518, 523
 bats, rabies virus reservoir 584
Bayou virus 545
Berne virus (BEV) 345
 M protein 348
 N protein 348
 S protein 348
 structure 347, 348
Bhanja virus 546, 547
 bilirubin, hepatitis 189
Birnaviridae 235, 248
 bismuth subsalicylate 236
BK virus (BKV) 619
 antibodies in serum and CSF 639–40
 brain tissue 633
 cell specificity 621
 CNS infection 633, 634–5
 disease associations 634–5
 DNA
 in human infection 631
 replication 623
 in tumours 637, 638
 IgM assays 640
 immune deficiency 634
 infection site 630
 JC virus concomitant infection 632–3
 kidney infection 634
 oncogenicity 636–8
 persistent infection 630
 T antigen expression 637
 tumour types 637
Black Creek Canal virus 545
 blood donors, HTLV infection 702, 708
 blood transfusion, CMV transmission 87
 body-cavity associated lymphoma *see*
 primary effusion lymphoma (PEL)
 Bolivian haemorrhagic fever
 clinical features 564
 diagnosis 562
 epidemiology 564–5
 transmission 565
Bolomys obscurus 569
 bone marrow transplant 12, 95, 105, 109
 adenoviruses 316, 321
 CMV 88–9
 HCMV 151
 HHV-6 and HHV-7 151
 HTLV-1 707
 KSHV 181
Bordetella pertussis 319
 Bornholm disease 438
Bovine coronavirus (BCV) 347
 HE proteins 350
 S proteins 350
Bovine leukaemia/lymphoma (ATLL)
 virus (BLV) 695
Bovine papillomavirus 4 (BPV-4) 612
 Bovine spongiform encephalopathy (BSE)
 711, 715–17
 cattle cull 717
 disappearance of epidemic 716
 prion origin 716–17
 bovine torovirus (BoTV) 345, 347
 structure 347, 348
 brain
 AIDS dementia 670
 BK virus (BKV) 633
 human polyomaviruses 634
 JC virus (JCV) 632, 633
 branched chain DNA (bDNA) 8, 10
 Brazilian haemorrhagic fever 569
 breast milk 85, 86, 95
 breast-feeding
 ATLL 708
 HIV infection 678
 HTLV-1 702
Breda virus 345

- bronchiolitis
 hyperinflation 296
 parainfluenza viruses 286
 respiratory syncytial virus 286, 296, 297, 299
- bronchitis 263
 respiratory syncytial virus 299
- bronchoalveolar lavage 2
- bronchodilators and respiratory syncytial virus 303
- bronchopulmonary dysplasia 300
- buffalopox 457
- Bunyamwera serogroup 518, 522–4
Bunyamwera virus 515, 518, 522–3
Bunyaviridae 515
Bunyavirus 515
 Anopheles serogroup A 518, 524
 antigenic grouping 518, 519
 biochemical properties 515
 biological characteristics 517, 519
 California serogroup 518, 525–7
 classification 515, 517, 518–19
 genome 517
 genus 518–19, 522–8
 glycoprotein spikes 516
 Guama serogroup 519, 527–8
 laboratory diagnosis 521–2
 Nyando serogroup 519, 527
 peplomers 516
 possible members 546–7
 serogroup C 518, 524–5
 serology 522
 Simbu serogroup 519, 527–8
 structure 516–17
 transmission 519–21
 virus detection/identification 521–2
- Burkitt's lymphoma 19, 117, 124, 131–4
 AIDS 138
 BL-derived cell lines 132
 chromosomal abnormalities 132
 clinical features 133
 cofactors 132, 134
 cyclophosphamide sensitivity 133
 diagnosis 133, 134
 EBV association 132
 epidemiology 131
 HHV-6–positive cell line 153
 macrophages 134
 malaria 132, 134
 mortality 133
 nucleolated lymphoid cells 134
 pathogenesis 132
 prevention 134
 sickle cell trait 132
 treatment 133–4
- Bwamba virus* 518, 524
- Cache Valley virus* 518, 523–4
Caliciviridae 235, 242–3
 calicivirus 235, 236
 AIDS 248
 classical 243, 244
 genome composition 243
 ORFs 243
- California encephalitis 518, 520
 serology 522
California encephalitis virus 518, 525–6
Calomys 563
Calomys callosus 564
Calovo virus 518, 523
Campylobacter 675
 candidiasis, oral in AIDS 674
Candiru virus 529
Canine coronavirus (CCV) 347
Canine distemper virus (CDV) 358
 canine parvovirus 647
 cannibalism, ritualistic 711, 713, 718, 725, 727
 cap snatching, *Influenza virus* 257
Caraparu virus 518, 524–5
 carcinoembryonic antigen (CEA) 349
 cardiac dysrhythmias, rabies 595
 cardiomyopathy, dilated 439–40
 Castleman's disease, multicentric 183
 cat, cowpox infection 455, 458, 460
Catu virus 519, 527
 caveolae, PrP^{Sc} formation 722–3
 caveolae-like domains (CLDs) 712
 CCR5 coreceptor 669–70
 CD4+ T cells
 HAV 193
 HHV-6 and HHV-7 141, 142–3, 155, 156
 HIV 667, 669, 670
 CD4:CD8 ratio, HIV infection 670
 CD4 cell surface antigen 669
 CD4 T cells
 antigen expression 156, 157–8
 cell death 686
 counts 12, 13, 667, 673, 683
 HCV 188
 lymphopenia 670–1
 soluble recombinant protein 686
 soluble tetrameric 688–9
 turnover 13
 CD8+ T cells 29
 HAV 193
 infectious mononucleosis 126, 129
 CD46 362–3
 cell culture, routine 1, 2
 cell-mediated immunity
 arenaviruses 559, 560
 Measles virus (MV) 377, 379, 381
 rabies 605–6
Central European encephalitis (CEE)
 virus 508, 509
 clinical features 510
 control 510
 epidemiology 509
 central nervous system (CNS)
 adenoviruses 321
 AIDS-associated PML 641
 congenitally-acquired rubella 402–3, 403–4
 coronaviruses 352–3
 enteroviral infection 437
 human polyomaviruses 631–2, 633, 634–5
 measles 370
 mumps 422
 poliovirus entry 444
 PrP^{Sc} accumulation 712
 Rabies virus 591–2
 see also brain
Cercopithecine herpesvirus 1 20
 cervical cancer 613
 cofactors 615
 cervical intraepithelial neoplasia, interferon therapy 617
 cervix, HPV infection 613–15
Chagres virus 529
 chaperones, prions 742
 chemokine receptors, HIV infection 669, 687
 chickenpox
 haemorrhagic 62
 see also varicella
Chikungunya virus 473, 474–6
 diagnosis 475–6
 haemorrhagic forms 475
 paediatric disease 475
 vaccine 476
 chimpanzee coryza agent see respiratory syncytial virus
 chorioretinitis, HSV 33
 chronic fatigue syndrome, enteroviruses 441–2
 chronic wasting disease 711
 cirrhosis 189
 HBV infection 218, 226
 HCV infection 224, 225, 226
 interferon therapy 226
 classification of viruses 13
 coeliac disease, adenoviruses 321
 cold sores xvii, 32
 common cold, rhinoviruses 329, 336
 complement fixation test 4
 condylomata acuminata 613
 congenital malformations and influenza 264–5
 conjunctivitis and enteroviruses 440
 contagious pustular dermatitis 459, 460
 cornea, ocular HSV xvii, 33
 corneal transplantation, iatrogenic CJD 723
Coronaviridae 235, 248
 coronaviruses 235, 248, 345
 aminopeptidase N (APN) 349, 350
 antigenic structure 349
 attachment process 350
 attachment to cells 349–50
 central nervous system 352–3
 enteric infections 345

- epidemiology 351–2
 epitope mapping 349
 glyicans 350–1
 glycoprotein spikes 346, 347
 growth *in vitro* 349
 haemagglutinin-esterase (HE) protein 348–9, 350
 HIV 352
 homosexual men 352
 human enteric tract 352
 lower respiratory tract disease 351
 multiple sclerosis 352–3
 receptors 349
 respiratory infections 345
 strains 345
 structure 345, 346, 347–8
 surface projections 345, 346
 tropism molecular basis 351
 upper respiratory tract disease 351
 virus-neutralizing antibodies 349
see also human coronavirus
- cot death syndrome *see* sudden infant death syndrome
- Cottontail rabbit papillomavirus* (CRPV) 612
- cowpox 458–60
 clinical features 458–9
 control 460
 diagnosis 459
 epidemiology 460
 lesions 458–9
 pathogenesis 458
- Cowpox virus* 458
 cytopathic effect (CPE) 459
 type A inclusions 455, 458
 vaccinia vaccination 457
- Coxsackie A virus 434, 435
 Bornholm disease 438
 herpangina 438
 isolation 442–3
 meningitis 437
 myopericarditis 439
 respiratory infections 438
 rubelliform rashes 438
 sequence comparisons 433
- Coxsackie B virus 434, 435
 Bornholm disease 438
 DNA probes 443–4
 IgM 443
 meningitis 437
 murine disease 440
 myopericarditis 438–9
 neonatal infection 437
 pancreatitis 441
 receptor sites 432
 respiratory infections 438
 sequence comparisons 433
- Coxsackie virus 247, 427
 infection prevention 444
- Coxsackie virus A1* 247
- Coxsackie virus A7*, polio-like illness 436
- Coxsackie virus B5*, Reye's syndrome 264
- CRE binding protein (CREB) 626
- Creutzfeldt–Jakob disease (CJD) 712
 amyloid plaques *xxiv*, 724, 731
 astrogliosis *xxiv*, 731
 contaminated material treatment 721–2
 corneal transplantation 723
 dementia 726
 dura mater grafts 723
 familial 711, 713, 714, 732
 Libyan Jews 733
 gene therapy 723
 Gerstmann–Sträussler–Scheinker disease association 728
 human growth hormone therapy 723–4
 iatrogenic 711, 723
 infectious 723–5
 kuru origin 727
 myoclonus 726
 neuropathology *xxiv*, 717, 731
 neurosurgical equipment decontamination 722
 octarepeat inserts 733
 penetrance 733
 prion decontamination 721–2
 prion inoculation 713
 PrP point mutations 733
 selective neuronal targeting 730
 spongiform degeneration 731
 sporadic 711, 717–23
 ancillary tests 719
 animal transmission 720
 biosafety practice 721
 brain biopsy 720
 care of patients 721
 clinical course 718
 clinical features 718
 diagnosis 718, 719
 differential diagnosis 719
 electroencephalography 718
 epidemiology 717–18
 immunology 720–1
 laboratory diagnosis 720–1
 myoclonus 718
 neuropathology *xxiv*
 prevention 722
 PRNP gene mutation 717
 protein 14–3–3 levels 719
 PrP gene polymorphisms 734
 S-100 protein 719
 therapeutics 722–3
- subclinical 722
 vacuolation 731
 variant 723, 724–5
 neuropathology *xxiv*, 724
 origin 724
 PrP glycoforms 725
- Crimean–Congo haemorrhagic fever 520, 521, 535–9
 antibodies 539
 prevalence 537
- clinical pathology 538
 control 539
 differential diagnosis 539
 distribution 536
 incubation 537
 infection 537
 laboratory diagnosis 539
 symptoms 537–8
 treatment 538–9
 virus isolation 536
- croup 280, 281–5
 attack rates 283–4
 influenza 262
 management 289
 virus isolation 283
- cryotherapy for HPV treatment 617
- Cryptococcus neoformans* 674
- Cryptosporidium parvum* 675
- Culex* mosquito 470, 471, 472
Bunyaviridae vectors 519
Japanese encephalitis virus vector 503
Murray Valley encephalitis virus vector 508
St Louis encephalitis virus vectors 505
Venezuelan equine encephalitis virus 480
West Nile virus vector 506, 507
Western equine encephalitis virus 479
- Culiseta* mosquito 471, 478
Highlands J virus 479
- cyclic AMP-response element (CRE) 626
 HTLV-I 705
- cystitis, adenovirus 320
- cytokines
 hepatitis B 210
 Kaposi's sarcoma-associated herpesvirus 171–2, 175
see also interleukins
- cytomegalic inclusion disease 92, 103
- cytomegalovirus (CMV)
 acyclovir 108, 109
 adenitis 94
 AIDS 92, 94, 106, 109–12, 674, 675
 amniotic fluid testing 103
 antibody prevalence 85
 antiviral drug strategies 107, 108, 109–10, 111, 112
 blood transfusion 87
 bone marrow transplantation 88–9, 95, 105, 109
 breast milk 85, 86, 95
 cell cultures 97
 cell-mediated immunity *xviii*, 91–2
 cellular functions 84
 cidofovir 107
 clinical features 92–5
 complement fixation 100
 congenital infection 92–3, 95, 101–2, 103–4
 prevention 105
 CPE 97, 98
 DEAFF technique 97, 98, 99

- cytomegalovirus (CMV) (*cont.*)
 diagnosis 95–7, 98, 99–101
 diarrhoeal disease 248
 disease prediction 89
 DNA detection 99
 drug resistance 14
 ear infection 93
 early proteins 83
 EIA 99
 electron microscopy 97
 epidemiology 84–6
 excretion rate 90
 Fc receptor expression 84
 foscarnet 107, 110, 111, 112
 ganciclovir 102, 107, 108, 109, 110, 111, 112
 genes *xvii*, 79–80, 92
 genital secretions 85, 86
 genome 80
 expression control 81–2
 glycoprotein complexes 83, 84
 Golgi apparatus 84
 growth *in vitro* 84
 gut infection 235
 HAART 112
 hearing loss 93
 HIV interaction 92, 248
 homosexual men 87, 106
 host defences 90–2
 humoral immunity 90–1
 IgG antibodies 90, 91, 101
 assays 100
 markers 100
 passive transfer 101
 prevalence 85
 IgM antibodies 90, 91, 101
 detection 100–1
 immediate-early genes 82, 83
 immune response detection 100–1
 immunocompromised patients 94–5, 96, 104–5
 prevention 105–7
 immunofluorescence 2–3
 assays 100
 incubation 89–90
 infection routes 86–8
 interferon- α 108, 109
 intranuclear inclusions 79, 96
 intrauterine infection 86
 JC virus interaction 627
 latex agglutination 3
 leaky-late genes 81
 leucocytes 96
 major immediate-early proteins 82, 83
 management 101–5
 mononucleosis 86–7, 94, 101, 103
 morphology 79
 multiplex PCR 7
 myelosuppressive 94, 95
 nucleic acid 79–80
 organ transplantation 11, 13, 87–90, 91, 94
 antiviral therapy 109
 immunosuppressive therapy 104–5
 owl's eye intranuclear inclusions 79, 96–7
 pathogenesis 88–92
 PCR assay 99
 sensitivity 11
 perinatal infection 85, 86, 93–4, 95, 101, 102
 plaque reduction assay 14
 pneumonitis 93–4, 102, 104, 110, 112
 postnatal infection 86–7, 94, 102–4
 ppUL83 protein 91, 96
 pre-emptive therapy 11–12
 pre-exposure immunization 106–7
 pregnancy 86, 88, 89, 90, 91, 95–6
 future 101–2
 primary 103, 104
 termination 103–4
 prevention 105–7
 prognosis 101–2
 prophylaxis 107, 108, 109
 protein cascade synthesis 81, 82
 proteins *xvii*, 82–4
 qualitative detection 11
 recurrent infection 86
 replication 83
 resistance to antiviral drugs 112
 retinitis 94, 110
 Reye's syndrome 264
 risk factors 88–9
 seroconversion 89
 sexual transmission 87
 sites for examination 95–6
 specimen collection 95
 strains 80, 83–4
 syndrome 94
 T cell immunotherapy 107
 TATA binding protein 82
 therapy 13
 tissue immunofluorescence 97
 transmission 85, 86
 in utero 91
 prevention 105–6
 treatment 107, 108, 109–10, 111, 112
 UL97 gene 15
 vaccine 106–7
 valaciclovir 109, 110
 vertical transmission 86
 virions 89
 virus isolation 1
 see also human cytomegalovirus (HCMV)
- cytopathic effect (CPE) 1, 2
 adenoviruses 322, 323
 arenaviruses 557
 Cowpox virus 459
 enteroviruses 442
 measles 378
 Rabies vaccine 604
- respiratory syncytial virus 302
 rhinoviruses 338
 Rubella virus 388, 393, 407
 cytosine arabinoside (ARA-C) 640–1
 cytotoxic T cells
 chronic hepatitis B 216
 EBV-specific 137
 enteric adenovirus 242
 hepatitis B infection 209–10
 HIV infection 689
 rotavirus 240
- Davidsohn–Henry test *see* heterophil antibody test
- deafness
 congenitally-acquired rubella 399, 400, 401, 403
 mumps 423
- decay accelerating factor (DAF) 432
- delta antigen (HDAg) 219
- dendritic cells, *Measles virus* (MV) 373–4
- dengue 497–502
 clinical features 499–500
 control 501–2
 diagnosis 500–1
 disease surveillance 502
 epidemics 497
 epidemiological surveillance 501–2
 epidemiology 498–9
 fever 497
 forest cycle 498
 history 497
 rural/semirural 498
 serological surveillance 502
 spread 498–9
 transmission cycles 498
 travel 498
 upsurge in endemic areas 498–9
 urban cycle 498
 vector control 502
 viral surveillance 502
- dengue haemorrhagic fever 497
- dengue haemorrhagic fever/dengue shock syndrome 499
 diagnosis 500
 immunological theory 500
 pathogenesis 500
 severity 499–500
 strain virulence theory 500
 virus serotypes 501
- dengue shock syndrome 497
- Dengue virus* 485, 491, 497
 host range 497–8
 properties 497–8
 serotypes 501
- Densovirinae* 645
- detection of early antigen fluorescent foci (DEAFF) technique 97, 98, 99
- diabetes mellitus
 congenitally-acquired rubella 399, 403
 enteroviruses 440–1

- influenza 265
 secondary bacterial pneumonia in influenza 264
 diagnostic assay, evaluation 10–11
 diarrhoeal disease 235–7
 adenovirus 241–2
 astroviruses 246–7
 CMV 248
 coronavirus 248
 Coxsackie virus A1 247
 HIV 248
 parvovirus 248
 reovirus 248
 rotavirus 237–41
 SRSVs 242–6
 torovirus 248
 treatment 236
 DiGeorge syndrome *see* athymic aplasia, congenital
 disease
 diagnosis 11
 prediction 11–12
 replication relationship 11–12
 DNA polymerase 6
 DNA viral genome 6
Dobrava virus 540, 542, 543, 544
Dolphin morbillivirus (DMV) 358
 drug resistance 14–16
 CMV 112
 HSV 14
 VZV 14, 72–3
 drug toxicity, rabies differential diagnosis 597
 drug users, intravenous, KS 182, 183
Dugbe virus 540
 Duncan's syndrome *see*
 lymphoproliferative syndrome, X-linked
 dura mater grafts, iatrogenic CJD 723
Duvenhage virus 584

 Eastern equine encephalitis (EEE) 469
Eastern equine encephalitis virus 477–9
Ebola virus 571
 antigens 575
 clinical features 579
 divergence from *Marburg virus* 574
 endemic 578
 envelope glycoprotein 575, 580
 epidemics 576, 577–8
 epidemiology 576–8
 genome sequence 573–4
 glycoproteins 574
 haemorrhagic manifestations 580
 inactivation susceptibility 573
 monkey infections 578
 nucleocapsid protein 575
 pathology 579–80
 prevention 580–1
 proteins 574
 replication 575
 serology 575–6
 strains 574–5
 surveillance 578
 transmission 577
 treatment 580–1
 ultrastructure 573
 virion 572
 zoonosis evidence 578
Echovirus 9, rubelliform rashes 438
 echoviruses 247, 434, 435
 decay accelerating factor (DAF) 432
 human group O erythrocyte agglutination 443
 infection prevention 444
 meningitis 437
 myopericarditis 439
 neonatal infection 437
 receptor sites 432
 Reye's syndrome 264
 sequence comparisons 433, 434
 eczema herpeticum 36
 electrodiathermy for HPV treatment 617
 electron microscopy 3
 encephalitis
 AIDS 155
 equine viruses 469, 477–9, 480–2
 herpes zoster 65
 herpetic 44
 HHV-6 150–1, 155
 HSV 34–5
 infectious mononucleosis 128
 influenza 262, 265
 measles
 inclusion body 369–70, 374
 postinfectious 370, 371, 374, 379, 381
 mosquito-borne 491
 mumps 423
 rabies differential diagnosis 596–7
 tick-borne 491, 508–10
 varicella 62
 virus genome detection 11
 see also Murray Valley encephalitis; rabies, encephalitic; *Russian spring–summer encephalitis* (RSSE) virus; St Louis encephalitis
 encephalopathy
 fulminant demyelinating 21
 influenza 264
 endocardial fibroelastosis 424
Entamoeba histolytica 675
 enteric infection
 coronaviruses 345, 352
 toroviruses 352
 see also gastroenteritis; gastrointestinal infection
 enterocytopathic human orphan viruses 427
 enterovirus 71, flaccid paralysis 436
 enteroviruses 235, 236, 427
 68–71 427
 animal viruses 434–5
 antigenic structure 430–1
 Bornholm disease 438
 cell cultures 442
 cellular receptor sites 431–2
 central nervous system spread 436
 cerebrospinal fluid 442, 444
 chronic fatigue syndrome 441–2
 classification 434
 clinical aspects 434–42
 CNS infections 437
 conjunctivitis 440
 cytopathic effect (CPE) 442
 diabetes mellitus 440–1
 dilated cardiomyopathy 439–40
 diseases 431–2
 encephalitis 437
 entry into body 435
 exanthemata 438
 gastrointestinal 247
 genome detection 443–4
 genomic RNA 429, 431, 432
 herpangina 438
 host range 435
 hypogammaglobulinaemia 437
 IgG 443
 incubation period 436
 infection prevention 444–6
 infectious particle 429
 laboratory diagnosis 442–4
 meningitis 437
 messenger RNA 432
 myopericarditis 438–40
 neonatal infection 437
 neurovirulence potential 440
 neutralization tests 443
 neutralizing antibody binding sites 431
 pancreatitis 440–1
 pathobiology 434–42
 PCR technique 444
 physical characteristics 427–9
 replication 435, 436
 strategies 432–4
 respiratory infections 438
 RNA synthesis 432–3
 sequence comparisons 433–4
 serological techniques 443
 serotypes 427
 target organs 435–6
 viraemic phase 435, 436
 viral culture 442
 virion structural proteins 429–30
 virion structure 428–9
 virus isolation 1, 442–3
 virus particle assembly 433
 see also human enteroviruses
 enzyme immunoassay (EIA) 99
 enzyme-linked immunosorbent assay (ELISA) 1, 3
 capture 4, 5
 competitive 4, 5

- enzyme-linked immunosorbent assay
(*cont.*)
formats 4–5
indirect 4–5
- epidemic haemorrhagic fever *see*
haemorrhagic fever with renal
syndrome (HFRS)
- epidermal growth factor receptor (EGFR)
610
- epidermodysplasia verruciformis 611–12
squamous cell carcinoma 613
virus association 615
- epilepsy, myoclonic 719
- Epstein-Barr virus* (EBV) 19, 117
AIDS 138
associated diseases 124–5
B cell immortalization 123
Burkitt's lymphoma 132
chronic fatigue syndrome 441
CR2 cell surface receptor 122
early genes 121–2
envelope 118
epidemiology 123–4
fatal haemophagocytosis syndrome 129
gene expression 120
genome 119, 170
glycoproteins 122
Hodgkin's disease 124, 127, 136
host range 122
human homologues 122
immediate-early genes 121
immortalization 120, 122–3, 124
Burkitt's lymphoma 132
immune compromised patients 117,
124, 136–8
infection 124
infectious mononucleosis 117, 125, 126,
128, 129–30
laboratory handling 123
late genes 122
latent infection 119
latent membrane protein (LMP) 120,
121, 123, 135, 136
latent proteins 119–21
lymphoproliferative lesions/lymphoma
117, 124, 128, 137
lytic cycle proteins 121–2, 137
nasal T cell lymphoma 124
nuclear antigen complex (EBNA)
119–20, 123, 129
Burkitt's lymphoma 132
Hodgkin's disease 136
X-LPS 137
oral hairy leucoplakia 124, 138
organ transplantation 137–8
PEL 183
seroconversion 117, 123
strains 119
variation 148
structure 117–18
vaccine development 138
- VCA antibodies 137
infectious mononucleosis 126, 128,
129, 130, 131
nasopharyngeal carcinoma 134, 135
X-LPS 137
viral capsid protein (VCA) 122, 123,
124
viral-coded proteins 119–22
virus-associated antigens 126
see also Burkitt's lymphoma; infectious
mononucleosis; nasopharyngeal
carcinoma
- Equidae see* horses
- equine rabies immune globulin (ERIG)
599–600, 602
- erythema infectiosum *xx*, 647, 648, 650–1
frequency 649
- erythema multiforme 36
orf 460
- erythrocyte P antigen 648–9
erythrocytes, *B19 virus* 652
Erythrovirus 645
European bat lassavirus 584–5
Everglades virus 480
- exanthem subitum *xix*, 21, 149
- exanthemata
enteroviruses 438
rubelliform rashes 438
- exotic ungulate encephalopathy 711
- extracellular enveloped virus (EEV) 452,
453, 454
- eye defects, congenitally-acquired rubella
404
- eye infection
adenoviruses 316, 317, 319–20, 325
herpetic 33, 44
Rift Valley fever 533
zoster 65
- facial palsy, herpes zoster 64, 65
- famciclovir
hepatitis B 214
herpes zoster 72
HSV 41, 42, 43
varicella 70
- fatal familial insomnia (FFI) 711, 712, 714
D178N mutation 734
PrP gene mutations 734
selective neuronal targeting 730
- fatal sporadic insomnia (FSI) 739
- Fc receptor, HSV infection 29
- Feline coronavirus* (FCV) 347
Feline infectious peritonitis virus (FIPV)
347
- feline spongiform encephalopathy 711
- fetal loss *see* abortion
- fever blisters *see* erythema infectiosum
- fifth disease *see* erythema infectiosum
- filoviruses 571
abortion 579
classification 571–2
- clinical features of infection 579
- epidemiology 576–8
gene products 573
genome 573
morphology 572
mortality 579
nomenclature 571–2
nucleic acid 573–4
nucleocapsid structural protein (NP)
573, 574
nucleocapsids 572
outbreaks 572, 577
pathology 579–80
physicochemical properties 572–3
postexposure prophylaxis 581
proteins 574
replication 575
sample handling 579
serology 575–6
ultrastructure 572, 573
vaccine development 580–1
variation among isolates 574–5
virion 572, 573
- Flaviviridae* 467, 485, 520
- Flavivirus* 485–6, 486
antigenic properties 490
biochemical/biophysical properties
488–9
genome 488
morphology 487, 488
see also *Yellow fever virus*
- flaviviruses 485
antigenic classification 491
geographical distribution 485
fluorescent antibody to membrane
antigen (FAMA) technique 69
- Fort Sherman virus* 518, 523–4
- foscarnet
HHV-7 159
HSV 42
- fusion (F) glycoprotein 279
- fusion (F) proteins, *Measles virus* (MV)
358
- gag cleavage sites 15
- ganciclovir
hepatitis B 213–14
HHV-7 158–9
HSV 42
- Ganjam virus* 540
- gastroenteritis 235
acute 237
astrovirus 247
diagnosis of viral 3
SRSV 245
see also enteric infection
- gastrointestinal infection, adenoviruses
317–18, 319, 320–1
- GB virus 227
- GB virus C (GBV-C)
biology 227–8

- clinical significance 228–9
discovery 227
prevalence 228
transmission 228
- gene therapy vectors, adenoviruses 326
- genital herpes 32
epidemiology 31
neonatal infection 32, 33, 34
recurrent 32
- genital secretions, maternal and CMV
transmission 85, 86
- genital warts
benign 613
pregnancy 615
- genotypic assays 15–16
- German measles *see* rubella
- Germiston virus* 518, 523
- Gerstmann–Sträussler–Scheinker disease
711, 712, 713, 714, 727–9
amyloid plaques *xxiv*, 728–9, 731–2
CJD association 728
clinical features 728–9
diagnostic evaluation 729
epidemiology 728
genetics 729
immunology 729
kuru association 728–9
neuropathology *xxiv*, 731–2
PRNP gene point mutations 728
PrP gene mutations 733
PrP point mutations 732
PrP-immunoreactive proteins 731–2
syndromes 728
transmission to animals 729, 732
white matter degeneration 732
- Getah virus* 482
- giant cell pneumonia in measles 369
- giant cells, multinucleate
measles 364, 368, 377
VZV infection 66
- giant pronormoblasts, *B19 virus* 649
- Giardia lamblia* 675
- globoside 648–9
- glomerulonephritis, *Barmah Forest virus*
474
- gluten intolerance, adenoviruses 321
- glycoprotein spikes
Bunyavirus 516
coronavirus 346, 347
HSV 24–5, 28
Respovirus 279
Rubella virus (RB) 389, 390
toroviruses 346, 347–8
- Guama serogroup 519, 527–8
Guama virus 519, 527
Guanarito virus 551, 569
Guaroa virus 519, 526–7
- Guillain–Barré syndrome
herpes zoster 65
infectious mononucleosis 128
influenza 265
- rabies differential diagnosis 596
- haemadsorption and *Influenza virus* 267,
268
- haemagglutination inhibition 4
- haemagglutinin (H) proteins in *Measles virus* (MV) 358
- haemagglutinin (HA)
Influenza virus 254–5, 256, 257,
258–9
host response 271
pathogenesis 262
virus classification 261
virus recognition 267
parainfluenza viruses 287
- haemagglutinin inhibition (HI)
antibody 271, 272, 273
tests 258, 259, 267, 268, 271
- haemagglutinin neuraminidase (HN)
glycoprotein 279–80
- haemagglutinin-esterase (HE) protein
347, 348–9
- haemagglutinin-esterase-fusion (HEF)
protein 348
influenza C virus 350
- Haemagogus* mosquito 477
yellow fever vectors 493
- Haemaphysalis* ticks
Ganjam virus vector 540
Kyasanur Forest disease virus vector
512
Powassan virus vector 512
- haemolytic anaemia
aplastic crisis 646, 647
B19 virus 649, 651
congenitally-acquired rubella 402
- haemophagocytosis syndrome, fatal
EBV-associated 129
- haemophilia
B19 virus infection 650
hepatitis B immunization 212
HIV infection 663
Kaposi's sarcoma 182
- haemorrhagic fever with renal syndrome
(HFRS) 520, 521, 540–1, 542,
543–6
Balkan 544
far eastern 543–4
incubation period 544
treatment 545–6
- hairy cell leukaemia 696
- hairy leucoplakia, oral 124, 138, 673
- hand, foot and mouth disease 438
- Hantaan virus* 540, 541, 542, 543, 544
- Hantavirus* 515
diagnosis 546
distribution 543
genus 540–1, 542, 543–6
infection 543
investigations 546
laboratory studies 546
- serological classification 541, 542, 543
- hantavirus pulmonary syndrome (HPS)
520, 540, 545
- Hazara virus* 516
- HBcAg synthesis 204
- HBeAg 199, 203
- acute hepatitis B diagnosis 207
chronic hepatitis B 212–13
diagnosis 208, 209
seropositivity 205
synthesis 204
- hemiparesis, contralateral in ophthalmic
zoster 65
- Henderson–Patterson bodies 461
- Hepacivirus* 486
- Hepadnaviridae* 200
- hepatitis 187
acute 187–8
albumin serum levels 189
autoimmune 194, 225
cholestasis 188
chronic 188
cirrhosis 189
clinical manifestations 189
endemic 196
enterically transmitted non-A, non-B
(ET-NANBH) 196, 197
fulminant 188, 189
icteric 188, 189
Kupffer cells 188
non-A, non-B 221, 227
pregnancy 189
prothrombin time 189
varicella 62
- hepatitis A antigen (HAAg) 193
- Hepatitis A virus* (HAV) 187, 189–90, 191,
192–6
age incidence 190
antigen 193
attenuated strains 195
biology 190, 192
cell culture 192–3
classification 192
clinical course 194
clinical signs 189
control 194–5
epidemics 190
faecal contamination 190
genetic organization 192
genome 192, 193
IgM 193
immunity 193
immunoglobulin immunization 194,
195
incubation 190
laboratory diagnosis 193, 194
mutation rate 193
particles 191
passive immunization 194, 195
pathogenesis 193
prevention 194–5

- Hepatitis A virus (HAV)* (*cont.*)
 reclassification 427
 recombinant vaccinia virus 195
 seasonal pattern 190
 serology 5
 seroprevalence 189–90
 spread 190
 structure 192
 vaccine 194, 195–6
- hepatitis B
 acute 209
 diagnosis 207–8
 alanine aminotransferase
 concentrations 207–8
 antiviral therapy 212–16
 childhood infection 213
 chronic 199–200, 205
 adefovir dipivoxil 215
 biologic response modifiers 215–16
 diagnosis 208
 DNA-based immunization 216
 famciclovir 214
 ganciclovir 213–14
 HBeAg 212–13
 IL-12 215–16
 immunotherapy 216
 interferon- α treatment 212–13
 lamivudine 214–15
 natural history 208–9
 nucleoside analogues 213–15
 thymosin therapy 216
 vaccine 216
 chronic glomerulonephritis 213
 cirrhosis 218, 226
 combined immunoprophylaxis 211
 control 210–16
 cytokine release 210
 diagnosis 206–9
 epidemiology 198–9
 fulminant 208, 209
 icteric 209
 immunization
 active 210–11
 DNA-based 216
 HBsAg 210
 indications 211–12
 passive 210
 interferon- α therapy 212–13, 226
 pathogenesis of infection 209–10
 prevention 210–16
 vaccination 211, 219, 221
- hepatitis B immunoglobulin (HBIG) 210
 combined immunoprophylaxis 211
 HBV prophylaxis 210
 immunization indications 212
- hepatitis B surface antigen (HBsAg) 198,
 199, 201–3
 active immunization 210
 acute hepatitis B diagnosis 207
 assay 206
 carrier 217, 218
 ELISA 3
 HDV coating 219
 phenotypes 202–3
 positivity in hepatocellular carcinoma
 216, 217
 pre-S region 211
 protein 201–2
- Hepatitis B virus (HBV)* 187
 antigen 201
 biology 200
 blood/blood product contamination
 198, 199
 carriers 199, 200, 211–12
 chronic hepatitis 188, 199–200
 core antigen 203
 disease prediction 12
 DNA assay 206–7
 DNA in primary liver tumours 217
 epidemiology 198–9
 extrahepatic tissues 205–6
 family clusters 199
 genome organization 202
 HBcAg expression 209
 HBeAg expression 209
 HBsAg phenotypes 202–3
 HDV helper function 219
 HDV superinfection 219, 220
 host immunity 209
 infection 205
 liver cancer 216–19
 oncogenesis mechanisms 218–19
 other species 200
 perinatal transmission 199
 pre-S proteins 218
 precore mutants 213
 pregenome reverse transcription 205
 prevalence 198, 200
 prodromal phase 189
 replication 203–5
 seroconversion 206
 serological tests 208
 serum DNA quantitation 12
 structure 200–1
 surface protein 200
 surface variants 203
 transmission 198–9
 vaccines 210–11, 221
 viral load decline 13
 virion 200
 X gene 218, 219
- hepatitis C
 acute 224
 chronic 224–5
 diagnosis 222–3
 interferon- α 224, 225
 prevention 226
 relapse 225
 ribavirin treatment 225–6
 treatment 224–6
- Hepatitis C virus (HCV)* 187, 485, 486
 antigens 188
 biochemical/biophysical properties
 489–90
 carriers 224
 diagnosis 10
 disease prediction 12
 genome 488
 genome organization 221–2
 genotypes 224
 hepatocellular carcinoma association
 224, 226
 immunoblot methods 5
 infection persistence 223–4
 liver enzymes 189
 LKM1 antibody 189
 non-A, non-B hepatitis 221
 pathological features 188
 PCR 223
 prevalence 223
 prodromal phase 189
 replication 222
 serological tests 223
 steatosis 188
 therapy response 13
 transmission 226
 prediction 13
 viral load decline 13
- hepatitis D
 clinical features 220
 fulminant 220
 HBV replication interference 220
 treatment 220–1
 vaccination 221
- Hepatitis D virus (HDV)* 187, 219–21
 anti-HD IgM 220
 epidemiology 219
 genome 219
 HBV helper 219
 HDAg coding 220
 laboratory diagnosis 220
 pathogenesis 220
 replication 219–20
 structure 219–20
- Hepatitis E virus (HEV)* 187, 196–8
 antibody 197
 biology 196–7
 clinical features 198
 diagnosis 197–8
 genome 197
 immunization 198
 incubation 196
 pathogenesis 197
 pregnancy 189
 seroprevalence 196
- Hepatitis G virus (HGV)* 227, 486
 biology 227–8
 clinical significance 228–9
 discovery 227
 prevalence 228
 transmission 228
- hepatocellular carcinoma (HCC)
 animal models 217

- core antigen expression 218
- environmental factors 218
- HBsAg positivity 216, 217
- HBV association 216–17
- HBV vaccination 219
- HCV association 224, 226
- incidence 216
- insertional mutagenesis 218–19
- oncogenesis mechanisms 218–19, 224
- promoter insertion hypothesis 218
- hepatocytes
 - acute hepatitis B 209
 - HBeAg expression 209
 - HBV infection 203
 - chronic hepatitis 188
 - hepatosplenomegaly, congenitally-acquired rubella 402
- Hepatitisvirus* 192
- herons, *Japanese encephalitis virus* dissemination 503
- herpangina, Coxsackie A virus 438
- herpes
 - aural 65
 - neonatal 33–4, 39, 44
 - perinatal infection 32, 33
 - ocular 32, 43–4
 - traumatic 36
- herpes febrilis 32
- herpes gladiatorum 36
- herpes keratitis 33
 - stromal 44
- herpes labialis 31, 32
- Herpes simplex virus* (HSV)
 - acyclovir 40–1, 43, 44
 - AIDS 673, 674–5
 - antigen sharing with VZV 53–4, 68
 - antigen-mediated capillary blot technique 40
 - antiviral chemotherapy 40–1
 - asymptomatic oral shedding 32
 - β -gene products 26
 - cell-mediated immunity 28–9, 40
 - clinical features 31–6
 - complement fixation tests 38–9
 - corneal graft *xvii*, 33
 - cross reactivity with VZV 53–4
 - CSF detection 39–40
 - diagnosis 36–40
 - DNA detection in CSF 37–8
 - drug resistance 14, 41
 - electron microscopy 37
 - encephalitis 34–5
 - epidemiology 29–31
 - erythema multiforme 36
 - famciclovir 41, 42, 43
 - Fc receptor 29
 - foscarnet 42
 - ganciclovir 42
 - gB glycoprotein 53
 - genital infection 32
 - genome 24
 - similarity to VZV 49
 - glycoprotein complex 29
 - glycoprotein post-translational modification 26
 - glycoprotein spikes 24–5, 28
 - gut infection 235
 - HIV infection, paediatric 678
 - human host 26
 - humoral immunity 28
 - IgA antibody 28
 - IgG antibody 28
 - IgM antibody 39
 - immune response to infection 28–9
 - immunization 42–3
 - immunoassay 37
 - immunocompromised patients 29, 35
 - immunofluorescence 2
 - in situ* hybridization 38
 - in situ* PCR 38
 - infection 26
 - latency 27–8
 - latency-associated transcripts 27
 - light microscopy 36
 - management 40–4
 - morphology 23–4
 - multiplex PCR 7
 - natural killer cells 28
 - neonatal 32, 33–4, 39, 44
 - nucleic acid detection 37, 38
 - nucleocapsid 25, 26
 - OCTs 26, 27
 - ocular infection *xvii*, 32–3, 43–4
 - oropharyngeal/orofacial infection *xvii*, 31–2
 - pathogenesis 26–9
 - PCR 37–8
 - penciclovir 41
 - peripheral blood antibody response 38–9
 - plaque reduction assay 14
 - reactivation 28
 - recurrent infection 43
 - replication 24–6
 - Reye's syndrome 264
 - secondary infection 43
 - serology 38–40
 - steroid therapy 43
 - tegument proteins 25
 - α -TIF 26, 27
 - transmission 26–8
 - vaccine 42
 - valaciclovir 41, 43
 - viraemia 26–7
 - virion escape 26
 - virus-induced modulation of immune response 29
 - viruses 23–4
 - culture 37
 - isolation 1–2
 - release 28
 - VZV cross-reactivity 53–4, 68
 - zosteriform 36
 - see also Human herpesvirus 1; Human herpesvirus 2*
- herpes zoster 49
 - acyclovir 71, 72
 - adjunctive treatment 72
 - AIDS 66
 - antiviral drugs 71–2
 - bacterial infection 64–5
 - complications 64–6
 - drug resistance 72–3
 - encephalitis 65
 - facial palsy 64, 65
 - famciclovir 72
 - forme fruste 64
 - Guillain-Barré syndrome 65
 - HIV infection 66
 - IgM antibody detection 69, 70
 - immunocompromised patients 64, 72
 - incidence 47
 - management 71–3
 - myelitis 65
 - neuralgia 65
 - penciclovir 72
 - recurrent infection 64, 66
 - serological diagnosis 68
 - transverse myelitis 65
 - urinary tract 64
 - vaccine for prevention 76
 - valaciclovir 72
 - VZIG treatment 73, 74
 - ZAP 65, 71
 - see also* ophthalmic zoster; *Varicella zoster virus* (VZV)
- Herpesviridae* 19–20, 235
 - capsid 19, 23, 24
 - classification 19–21
 - envelope 24
 - genome expression control 81–2
 - infection 19
 - morphology 23–4
 - nomenclature 20
 - oncogenic associations 19
 - reactivation 19
 - subfamilies 19
 - tegument 19, 24
 - torus 23
 - transmission 19
 - see also* cytomegalovirus (CMV); *Epstein-Barr virus* (EBV)
- herpesvirus
 - latency 158
 - PCR 3
 - phylogenetic relationships 168, 169
 - skin lesion electron microscopy 3
- herpetic dermatitis 32, 35–6
- herpetic eye disease 33
 - late stage 44
- herpetic whitlow 32, 36
- heterophil antibody test 130
- Highlands J virus* 479

- highly active antiretroviral therapy
(HAART) 674, 675, 677, 683, 684, 685
 CMV disease 112
 cost 686
 IL-2 combination 687
 rebound 686
- histamine
 rhinoviruses 334
 vascular leakage 334
- HIV infection
 AIDS defining illness 671
 anogenital squamous carcinoma 677
 antiretroviral drugs 682–3, 683–5, 690
 apoptosis 667, 686
 astroviruses 247
 asymptomatic phase 673
 BK virus (BKV) and *JC virus* (JCV)
 concomitant infection 632–3
 breast-feeding 678
 CCR5 receptor 687
 CD4:CD8 ratio 670
 CD4
 cell death 686
 counts 12, 13, 667, 673, 683
 lymphopenia 670–1
 soluble recombinant protein 686
 soluble tetrameric 688–9
 cell-mediated immunity 689
 chemokine coreceptors 687
 chronic activation 669
 classification 670, 672
 of effects 671
 clinical disease 670–1, 672, 673–81
 clinical phase 668
 CMV
 IgG antibody prevalence 85
 interaction 92, 248
 commercial assays 681
 CXCR4 coreceptor 687
 cytotoxic T lymphocytes 689
 developing world 663
 diagnosis 679–81
 neonates 680
 diarrhoea 675
 drug action sites 682
 drug resistance 685
 EBV 138
 encephalopathy in children 679
 fluid phase immunohumoral
 transmitters 687
 gp120 669, 688, 689
 gp160 688, 689, 690
 haemophilia 663
 heterosexual transmission 663, 690
 HHV-6 and HHV-7 154–6
 HLA types 669
 homosexual transmission 662, 663
 Human papillomavirus 675
 immunological phase 668
 immunosuppression 673
- immunotherapy 687–8
 integrase inhibitors 684
 Kaposi's sarcoma 181, 182–3, 675–7
 KSHV distribution 180–1
 lymph node infections 156
 lymphadenopathy 670, 673
 lymphocyte count 670
 lymphocyte depletion 667
 lymphoid tissue infection 667
 management 670–1, 672, 673–81
 measles vaccination 383
 molluscum contagiosum 462, 675
 monitoring 679–81
 mucocutaneous disease 670
 neonatal 690
 new antiviral targets 686–7
 new therapies 686
 non-Hodgkin's lymphoma 677
 nucleoside reverse transcriptase
 inhibitors (NRTI) 682–3
 paediatric 678–9
 antiretroviral therapy 679
 classification 670, 672
 clinical 677–8
 infection 672
 presentation 678–9
 passive immunization 687
 pathogenesis 667, 668, 669–70
 PCR 680, 681
 PML 631–2, 636
 Poxvirus 675
 pregnancy 678
 primary 667, 670–1
 progression to disease 12, 669
 protease 686
 protease inhibitor drugs 683, 684
 receptor attachment 686
 recurrent HSV infection 35
 reverse transcriptase 686
 rubella vaccination 411
 serology 679, 680
 symptomatic disease 673
 therapy 682–5
 goal 12
 initiation 12
 targets 686
 timing 685
 triple 684–5
 TNF receptor 667
 vaccines 688–90
 animal models 689–90
 candidate 688–9
 CTL epitopes 689
 development 691
 envelope 688, 689, 690
 envelope-based immunogens 688
 human trials 689–90
 live attenuated 688
 therapeutic 687–8
 vertical transmission prevention 690
 viral load decline 13
- virological phase 668
 VZV 58
 women infected 690
 worldwide prevalence 663, 664
 zoster 66
 see also acquired immune deficiency
 syndrome (AIDS); highly active
 antiretroviral therapy (HAART);
 human immunodeficiency virus
 (HIV)
- HIV-associated encephalopathy 674
 HLA types 669, 707
- Hodgkin's disease
 EBV 124, 127, 136
 HHV-6 153
 VZV 58
- homosexual men 106
 CMV 87
 coronaviruses 352
 HIV infection 662, 663
 KSHV 180, 182, 183
- horses
 alphaviruses 469
 Eastern equine encephalitis virus 477,
 478
 Venezuelan equine encephalitis virus 480
- HTLV-I-associated myelopathy/tropical
 spastic paraparesis (HAM/TSP)
 699, 702
 antiretroviral therapy 707–8
 disease prevention 708
 HLA types 707
 HTLV-1 CTLs 706
 pathogenesis 706–7
 peripheral lymphocytes 706
 prevalence 704
 proviral load 706, 707
 treatment 707–8
- Hu prions 737–8
 human coronavirus 345, 347
 cell receptors 349–51
 clinical features 351–3
 diagnosis 353–4
 epidemiology 351–2
 genes 348
 growth *in vitro* 349
 haemagglutinin-esterase (HE) protein
 348
 incidence 352
 M protein 348
 N gene cloning 354
 N protein 348
 protein detection 354
 protein sequence 348–9
 RNA detection 354
 serological response 352
 serology 354
 treatment 354–5
 virus isolation 353–4
- human cytomegalovirus (HCMV)
 AIDS 155

- antigenic targets 157
- antiviral drugs 158–9
- bone marrow transplantation 151
- gene regulation 146
- genome organization 144, 145, 146
- HHV-6 and -7 relationship 144
- organ transplantation 151
- retinitis 155
- strain variation 148
- virus culture 37
- human endogenous retroviruses (HERV) 661
- human enteroviruses 434–5
- human foamy virus (HFV) 661
- human growth hormone therapy, iatrogenic CJD 723–4
- human herpesvirus 20
 - oncogenic associations 19
 - phylogenetic relationships 141, 142
 - U1102 strain 141
 - Z29 strain 141
 - see also* herpes simplex virus (HSV)
- Human herpesvirus 1* (HSV-1) 23
 - capsid 24
 - CPE 37
 - ELISA procedures 39
 - encephalitis 34
 - envelope 24
 - genetic map 24
 - genome 23–4
 - glycoprotein spikes 25, 28
 - immunization 42
 - infection 26
 - neonatal 34, 44
 - ocular 32
 - primary 29, 30
 - recurrent 31
 - site 27
 - maternal immunity 30
 - morphology 23–4
 - reinfection 31
 - seroconversion 30
 - seroepidemiology 31
 - seroprevalence 30
 - tegument 24
 - transcapsomeric channels 24
 - virus culture 37
 - virus release 28
 - see also* Herpes simplex virus (HSV)
- Human herpesvirus 2* (HSV-2) 23
 - capsid 24
 - CPE 37
 - ELISA procedures 39
 - encephalitis 34
 - envelope 24
 - genetic map 24
 - genital 32
 - genome 23
 - glycoprotein spikes 25, 28
 - immunization 42
 - infection 26
 - neonatal 33, 34, 44
 - primary 29, 30–1
 - recurrent 31
 - site 27
 - morphology 23–4
 - reinfection 31
 - seroprevalence 30
 - tegument 24
 - transcapsomeric channels 24
 - transmission 30
 - virus culture 37
 - see also* Herpes simplex virus (HSV)
- Human herpesvirus 6* (HHV-6) 21, 141, 143–4
 - acyclovir 159
 - AIDS 141, 148, 153, 154–6, 160
 - antigenic targets 156–7
 - antiviral drug sensitivity 158–9
 - balloon cells 141, 143
 - bone marrow transplantation 151, 159
 - Burkitt lymphoma cell line 153
 - CD4+ T cells 141, 142–3, 155, 156
 - cell-mediated response 157
 - clinical characteristics 148–54
 - CPE 141, 143
 - cytokine regulation 158
 - diagnosis 153–4
 - disseminated infection 154–5
 - encephalitis 150–1, 155
 - exanthem subitum *xix*, 149
 - fever 149, 150
 - foscarnet 159
 - ganciclovir 158–9
 - gene regulation 146, 155–6
 - gene therapy 159–60
 - genes 144, 146, 148
 - genome organization 144, 145
 - genomic sequence 144
 - glycoproteins 144, 146
 - growth 142–3
 - HIV infection 154–6
 - Hodgkin's disease 153
 - immune evasion 158
 - immune reaction 156–8
 - immune therapy 160
 - immunosuppression 157–8
 - immunosuppressive action 152–3
 - infection
 - primary 148–50
 - secondary 150–2
 - sequential 149
 - isolation 142
 - latency 158
 - lymph node infections 156
 - misdiagnosis 150
 - molecular biology 144, 145, 146, 147, 148
 - multiple sclerosis 152
 - neurological conditions 151–2
 - neutralizing antibodies 156–7
 - oncogenic activity 153
 - organ transplantation 141, 151
 - p100 antigen 157
 - PCR 143
 - pneumonitis 151, 153, 155
 - quantitative detection 11
 - rash 149, 150
 - salivary gland epithelium 143
 - small T cell lymphoma 153
 - strain variation 147, 148
 - T cells 142–3
 - therapy 158–60
 - transmission 143
- Human herpesvirus 7* (HHV-7) 141
 - AIDS 141, 148, 153, 154–6, 160
 - antigenic targets 156–7
 - antiviral drugs 158–9
 - balloon cells 141
 - bone marrow transplantation 151
 - CD4+ T cells 141, 142–3, 155, 156
 - cell-mediated response 157
 - clinical characteristics 148–54
 - CPE 141
 - diagnosis 153–4
 - exanthem subitum 149
 - fever 149, 150
 - foscarnet 159
 - ganciclovir 158–9
 - gene regulation 146
 - gene therapy 159–60
 - genes 144, 146, 148
 - genome organization 144, 145
 - genomic sequence 144
 - glycoproteins 144, 146
 - growth 142–3
 - HIV infection 154–6
 - immune reaction 156–8
 - immune therapy 160
 - immunosuppression 157–8
 - immunosuppressive action 152–3
 - infection
 - primary 148–50
 - secondary 150–2
 - sequential 149
 - isolation 142
 - latency 143–4
 - misdiagnosis 150
 - molecular biology 144, 145, 146, 147, 148
 - neurological conditions 151–2
 - neutralizing antibodies 157
 - organ transplantation 141, 151
 - p100 antigen 157
 - PCR 143
 - quantitative detection 11
 - rash 149, 150
 - salivary gland epithelium 143
 - strain variation 148
 - T cells 142–3
 - therapy 158–60
 - transmission 143

- Human herpesvirus 8* (HHV-8) 19, 675–6, 677
 see also Kaposi's sarcoma-associated herpesvirus (KSHV)
- human immunodeficiency virus (HIV)
 235, 248, 662
 antigens 666
 antiretroviral therapy 667
 bDNA method 8
 CCR5 coreceptor 669–70
 CD4+ cells 669, 670
 cell tropism 669–70
 chemokine receptors 669
 classification 662
 coronaviruses 352
 culture and isolation 664
 diagnosis 10, 666
 ELISA 679, 680
env gene 665
 envelope 688, 689, 690
 epidemiology 662–4
gag gene 665
 gene transactivation by HHV-6 155–6
 genome 664–6
 detection 666
 HLA sequences 669
 immunoblot methods 5
 isolation 664
JC virus interaction 627
 life cycle 682
 load 666–7
 NASBA 8
nef gene 666
nef proteins 669
 neutralizing antibodies 666
 p24 antigen, ELISA 3
 PCR 8
pol gene 665
 propagation 664
 proteins 664–6
 proviral DNA detection 667
 receptors 669–70
 replication
 attachment to receptors 686
 fusion with cell membrane 686–7
 high-frequency error-prone 685
 resistance 666–7
 marker measurement 667
rev gene 665
 RNA quantitation 3, 12
 serology 666
 subpopulations in different organs 670
 susceptibility assays 14–15
tat gene 665
 vertical transmission 13
vif gene 666
 viraemia detection 666
 virology 664–7
 virus turnover 686
vpr gene 666
vpu gene 666
- see also HIV infection; Kaposi's sarcoma-associated herpesvirus (KSHV)
- Human immunodeficiency virus type 1* (HIV-1) 661, 662
 clades 663–4
 genome map 664–6
 groups 662
 isolation 662
 non-syncytium-inducing 662
 phenotypes 662
 R5 viruses 662
 subtypes 662, 666
 syncytium-inducing 662, 663
 Tat protein 183
 X4 viruses 662
- Human immunodeficiency virus type 2* (HIV-2) 661
 genome map 664–6
 isolation 662
 phenotypes 662
 transmission rate 664
- human immunoglobulin treatment, *B19 virus* 656
- Human papillomavirus* (HPV) 607
 anogenital squamous carcinoma 677
 cross-reactivity 610
 cryotherapy 617
 culture methods 615
 curettage 617
 early (E) proteins 608–10, 611
 electrodiathermy 617
 ELISA 615
 genital cancers 613
 genital tract infections 607, 612
 genital warts 613, 615
 genome 608, 609
 histone (H) proteins 610
 HIV infection 675
 HTLV-I association 704
 hybrid capture methods 616
 infection
 natural history 611–12
 persistence 615
 interferon 617
 laboratory diagnosis 615–16
 laser evaporation 617
 late (L) proteins 610
 loop electrosurgical excision procedure (LEEP) 617
 mapping 611
 mucotropic 612
 oncogenic potential 612–13
 pathogenesis 612–15
 PCR methods 616
 popophyllin 616–17
 premalignant lesions 613, 614
 replication 609–10, 610–11
 serology 610, 615–16
 solid phase assays 6
 transmission 612
- treatment 616–17
 viral coded proteins 608–10
 viral-like particles (VLPs) 610
 virion 607
- Human papillomavirus-6* (HPV-6) 614
Human papillomavirus-11 (HPV-11) 611, 614
Human papillomavirus-16 (HPV-16) 607, 611, 614
Human papillomavirus-31 (HPV-31) 611
 human parvoviruses 645
 see also *B19 virus*
- human polyomaviruses
 antibodies in CSF 640
 asymptomatic activation of infection 633–4
 brain tissue 634
 capsid (P) proteins 619
 capsid (VP) proteins 622
 classification 619
 CNS infection 631–2, 633
 detection 619
 diagnostic evaluation of associated disease 638–40
 disease associations 634–6
 diseases 630
 DNA
 in CSF 638–9
 replication 622–3
 sequence homology 621–2
 in tumours 637–8
 enzyme immunoassay 639–40
 gene expression control 622–7
 genome molecular structure 621–2
 genomic heterogeneity of viral subtypes 627–30
 haemagglutination 619
 inhibition 639
 immune system impairment 628
 immunocompromised patients 634
 infection
 activation 628
 course 631
 treatment 640–1
 interferon therapy 641
 large T antigen (TAg) 620, 621
 late mRNA expression 620
 life cycle 620–38
 neutralization 619
 nuclear factor κ B 624
 nucleoside analogues 640–1
 oncogenicity 636–8
 origin of DNA replication (ORI) 621, 622, 623, 624
 PCR techniques 638–9
 peripheral leucocytes as target cells 632
 phosphorylation events 620
 pregnancy 633
 primary infection 630
 renal transplantation 633
 start codons for early/late genes 622

- subtype control region transcriptional activity 629
 TAG oncogenic potential 636, 637
 transcriptional control region (TCR) domains 623, 624
 transcriptional expression 623–7
 transforming activity 622
 transient viraemia 633
 tumour (T) antigens 622
 viral DNA replication initiation 620
 virion structure/composition 619
see also BK virus (BKV); JC virus (JCV)
 human rabies immune globulin (HRIG) 599–600, 602
Human retrovirus 5 (HRV-5) 661
Human T-cell lymphotropic virus (HTLV) 695–6, 697, 698
Human T-cell lymphotropic virus I (HTLV-I) 661, 695
 associated disease 703–5
 ATLL pathogenesis 705–6
 blood donors 702, 708
 blood products 702
 bone marrow transplant 707
 breast-feeding 702
 carcinogenicity 703–4
 cyclic AMP-response element 705
 diagnosis 698–9
env gene 698
 envelope 696
 epidemiology 696, 699, 702
gag genes 696, 698
 genome 696, 697
 HPV association 704
 lymphocytic infiltration *xxi*, 704
 morphology 696
 mother-to-child transmission 708
 mycosis fungoides association 704
 NF κ B binding site 705, 706
pol gene 698
 reverse transcriptase 696
 Rex protein 698
 seroprevalence *xxi*, 699, 702, 703, 704
 serum responsive element 705
 Sjögren's syndrome association 704
 STLV-I relationship 699, 700–1
Strongyloides stercoralis association 704
 syncytial assay 696
 target sequences 705
Tax gene 698
Tax protein 705–6
 transmission 702
 tuberculosis association 704
 uveitis 704
 viral variation 699
Human T-cell lymphotropic virus II (HTLV-II) 661, 695
 blood donors 702, 708
 diagnosis 698–9
 genome 696, 697
 identification 696
 injecting drug users 699–700, 702
 morphology 696
 Rex protein 698
 seroprevalence *xxi*, 699, 703
Tax protein 698
 transmission 702
 tuberculosis association 704
 viral variation 699
 humoral response 3–4
 Hutchinson's sign 64
Hyalomma ticks, Crimean–Congo haemorrhagic fever 536, 537
 hydrophobia, rabies 594, 596
 hydrops fetalis, *B19 virus* 647, 653, 655
 hypogammaglobulinaemia, enteroviruses 437
 hypoxaemia, respiratory syncytial virus 302

Igbo Ora virus 476
 IgG
 antibody avidity 68
 capture assay 4, 5
 enteroviruses 443
 indirect assay 4, 5
 response 4
 rubella-specific 406, 407, 408–9
 IgM
 capture assay 4, 5
 Coxsackie B virus 443
 indirect assay 4, 5
 response 4
 rubella-specific 405, 406–7, 408, 409
Ilesha virus 518, 523
 immunocompromised patients 96, 104–5
 adenovirus 5 317
 adenoviruses 321–2
B19 virus 653
 CMV 94–5, 105–7
 EBV 117, 124, 128, 136–8
 giant cell pneumonia in measles 369
 herpes zoster 64, 72
 HSV 35
 human polyomaviruses 634
 lymphoma 132, 137
 lymphoproliferative lesions/lymphoma 117, 124, 137
 measles vaccination 383
 varicella 71, 75
 immunodeficiency
BK virus (BKV) 634
 congenital 653
 immunofluorescence 2–3, 4
 immunohumoral transmitters in HIV infection 687
 immunosuppression 12
 herpes zoster risk 47
 HSV infection 29
 respiratory syncytial virus 300, 301
 varicella risk 47
 inclusion bodies, intracytoplasmic *see* viroplasm
 inclusion body encephalitis and measles 369–70, 374
 α -trans-induction factor (α -TIF) 25, 26, 27
 infection
 diagnosis 10–11
 staging 11–12
 infectious mononucleosis 125–31
 anti-VCA IgM test 130, 131
 autoantibodies 126
 cellular immunity 126–7
 children 128
 chronic 129
 clinical features 127–8
 complications 128–9
 convalescence 128
 course of illness 128
 diagnosis 130–1
 elderly 128
Epstein–Barr virus 117, 125, 126, 128, 129–30
 hepatic complications 128–9
 hepatocellular damage 129
 heterophil antibody test 130
 histology 127
 humoral immunity 125–6
 immunocompromised patients 128
 immunological complications 129
 incubation period 127
 laboratory findings 129
 lymphadenopathy 127, 128
 lymphoproliferative disease 128
 monospot test 130–1
 mortality 128
 neurological complications 128
 pathogenesis 125–7
 peripheral blood mononuclear cells *xviii*, 126
 pharyngeal obstruction 129
 physical signs 127–8
 pregnancy 128
 PVFS 128, 129
 seroconversion 125
 seropositivity 125
 splenic rupture 129
 symptoms 127
 tracheal obstruction 129
 transmission 125
 treatment 131
 vaccination 138
 VCA antibodies 126
 virus-associated antigens 126
 influenza 253–4
 amantadine 269, 270
 bronchitis 263
 clinical features 262–3
 congenital malformations 264–5
 diabetes mellitus 265

- influenza (*cont.*)
 diagnosis 265–8
 encephalitis 265
 encephalopathy 264
 epidemics 253, 257, 258, 260
 4–guanidine-neu5Ac 2en (GG167) 269, 271
 Guillain–Barré syndrome 265
 immune status of population 259, 260, 261
 immunity 271–2
 incubation period 263
 myalgia 264
 myoglobinuria 264
 myositis 264
 pandemics 253, 257–8, 259, 260
 pathogenesis 262
 pathological specimens 266
 patterns 258
 pneumonia 263–4
 pregnancy 264–5
 prevention 268–9, 271–5
 Reye's syndrome 264, 265, 270
 ribavirin 269, 271
 rimantadine 269, 270
 Spanish 257–8
Staphylococcus aureus 265
 sudden infant death syndrome 265
 symptoms 263
 toxic shock syndrome 265
 tracheobronchitis 263
 treatment 268–71
 antiviral compounds 269, 270–1
 symptoms 269–70
 vaccination 272–5
- Influenza virus*
 A strain 255, 259, 261, 263, 264
 acute respiratory infection 285
 abortive infection 255
 antigenic drift 260–1
 antigenic shift 258–60
 avian 260
 B strain 255, 259, 261, 263, 264
 C strain and
 haemagglutinin-esterase-fusion (HEF) protein 348, 350
 cap snatching 257
 classification 261–2
 complement fixation 267
 composition 254
 culture in embryonated eggs 266
 ELISA 267
 glycoproteins 254–5
 haemadsorption 267
 inhibition test 268
 haemagglutination 266
 haemagglutinin (HA) 254–5, 256, 257, 258–9
 host response 271
 pathogenesis 262
 virus classification 261
 virus recognition 267
 haemagglutinin inhibition (HI) antibody 271, 272, 273
 tests 258, 259, 267, 268, 271
 identification 266–7
 immunofluorescence 267
 immunoreactions 267
 isolation 253, 266–7
 matrix protein (M1) 254, 257
 molecular biology 267–8
 mRNA synthesis 256–7
 mutations 259
 neuraminidase (NA) 255, 257, 261, 262, 267
 antigen 272, 275
 host response 271
 neuraminidase-inhibiting (NI) antibody 272, 274
 new subtypes 259, 260
 non-structural (NS) proteins 255, 256
 nucleoprotein (NP) 254, 256, 257
 P-proteins 255, 256
 pathogenesis 262
 PCR 268
 permissive infection 255–6
 pyrogenicity 262
 rapid diagnosis 267–8
 recognition 267
 replication 256–7
 RNA 268
 serology 268
 single radial haemolysis technique 268
 strain classification 267
 structure 254–5
 subtypes 259
 classification 267
 tissue culture 266–7
 vaccine 272–5
 attenuated 274
 genetic engineering 274
 live virus 273–4
 split virus 272–3
 subunit virus 273
 Vaccinia virus 274–5
 whole virus 272
 virus
 isolation 1
 variation 257–62
 Von Magnus phenomenon 255
 injecting drug users, HTLV-II 699–700, 702
Inkoo virus 518, 526
 insertional mutagenesis 218–19
 integrase inhibitors 684
 intercellular adhesion molecule 1 (ICAM-1) 332, 341
 interferon
 contraindications to therapy 213
 hepatitis B therapy 212–13, 226
 HPV therapy 617
 human polyomavirus infection
 treatment 641
 Mumps virus 421–2
 interleukin-1 (IL-2) 160
 interleukin-2 (IL-2)
 HAART combination in HIV 687
 HIV propagation 664
 interleukin-2 receptor (IL-2R), ATLL 705–6
 interleukin-2 receptor (IL-2R α) gene, ATLL 705–6
 interleukin-6 (IL-6) 171, 184
 interleukin-10 (IL-10) 122
 interleukin-12 (IL-12)
 chronic hepatitis B therapy 215–16
 Measles virus (MV) 372
 synthesis inhibition 365
 intracellular naked virus (INV) 452, 453
 intranuclear inclusions
 adenoviruses 313, 314
 owl's eye of CMV 79, 96–7
 VZV infection 52, 53
 intrauterine growth retardation, congenitally-acquired rubella 402
 intussusception, adenoviruses 321
 iridocyclitis
 herpetic 44
 HSV 33
Isospora belli 675
Issyk-Kul virus 546, 547
Itaqui virus 518, 524–5
Ixodes ticks
 Bunyaviridae vectors 519, 520
 Central European encephalitis (CEE) virus vector 509
 Nairobi sheep disease virus vector 539
 Omsk haemorrhagic fever vector 510–11
 Powassan virus vector 512
 Russian spring–summer encephalitis (RSSE) virus 509

Jamestown Canyon virus 518, 526
 Japanese encephalitis 485, 491, 502–5
 host range 502–3
Japanese encephalitis virus
 clinical features 503–4
 control 504
 diagnosis 504
 dissemination 503
 epidemiology 503
 features 502–3
 pathology 503
 prognosis 503
 target cells 503
 vaccines 504
 vector control 504
JC virus (JCV) 619, 620
 antibodies in serum and CSF 639–40
 BK virus (BKV) concomitant infection 632–3
 brain tissue 632, 633

- cell specificity 621
 CMV interaction 627
 CNS infection 633, 634
 CNS spread in PML 631–2
 CRE binding protein (CREB) 626
 cyclic AMP-responsive element (CRE) 626
 disease associations 635–6
 DNA
 in human infection 631, 632
 replication 623
 in tumours 637
 genomic heterogeneity of viral subtypes 627–30
 genotypes 628
 glial cell specificity 636
 glial factor 1 (GF-1) 626
 GRS motif 625–6
 heterologous transactivation of transcription 627
 high mobility group (HMG) proteins 625
 HIV interaction 627
 human infection 630
 IgM assays 640
 life cycle 620–1
 lytic control element (LCE) 625, 626
 minimal core promoter (MCP) 625
 NF-1 binding sites 626
 non-coding region changes 628
 nuclear factor κ B 624, 626–7
 oncogenicity 636
 origin of DNA replication (ORI) 624–5
 persistent infection 630–2
 PML 635–6, 674
 diagnosis 638
 specific antibodies 640
 promoters 623–4
 pur α 625, 626
 subtype control region transcriptional activity 629
 TAg 625, 626
 transcriptional control elements (TCR) 621, 627, 628–9
 transforming activity 622
 Tst-1 proteins 625, 626
 YB-1 625, 626–7
 joints, *B19 virus* infection 651
Junin virus 555, 557, 559, 562
 pathogenesis 560–1
 reservoir hosts 563
 transmission 563
 vaccine 564, 568
 Kaposi's sarcoma 19
 AIDS-associated 175, 181, 182, 662, 673, 675
 antiretroviral therapy 175
 classical 179–80, 181, 182
 cofactors for development 182–3
 endemic 179
 haemophilia 182
 HHV-7 144
 HIV/AIDS 675–7
 KSHV 181–2
 latency-associated nuclear antigen (LANA) 173
 presentation 676
 spindle cells *xix*, 171, 172, 173
 treatment 676–7
 Kaposi's sarcoma-associated herpesvirus (KSHV) 167, 168–9
 antibody assays 176–7, 179
 antiviral therapy 175
 Bcl-2 homologue 172
 bone marrow transplantation 180
 cellular proliferation interference 181
 culture 167–8
 cytokines encoded by 171–2, 175
 D-type cyclin 173
 distribution with HIV transmission risk 180–1
 DNA detection by PCR 176
 epidemiology 177, 179–81
 FLICE-inhibitor protein (v-FLIP) 172, 173
 G-protein-coupled receptors 171
 genes 169
 classes 174–5
 conserved viral 169–70
 latent *xix*, 181
 genome 170
 organization 168–9
 geographical distribution 177, 179
 IL-6 homologue 171, 184
 immunofluorescence assay 177, 178, 179
 interferon regulatory factors (v-IRFs) 172, 175
 Kaposi's sarcoma 181–2
 latency-associated nuclear antigen (LANA) 177, 178
 latent infection *xix*, 181
 latent membrane proteins (LMP) 171
 latent nuclear antigen (LNA) 173, 177
 latent persistence 173–5
 lytic replication *xix*, 173–5, 177
 MIP homologues 171, 172, 182, 184
 morphology 167–8
 multicentric Castleman's disease 183
 neoplastic disease 181–4
 non-conserved 170–3
 ORF K15/LAMP transcript 170, 171, 175
 ORF proteins 170–3, 175
 organ transplantation 180
 PCR 179
 PEL 183
 phylogeny 168–9
 proteins 182
 with antiapoptotic properties 172
 serological assays 176, 177
 seroprevalence 179, 182
 sexual transmission 180–1
 subtypes 175
 transmembrane proteins 170–1
 transmission 180
 untranslated RNA 173
 v-cyclin 173
 vascular endothelial growth factor 171
 Vcl-2 homologue 172
 virion 167–8
 Karelian disease 470
Kasokero virus 546, 547
 keratitis, ocular HSV 33, 44
 keratoconjunctivitis
 adenoviruses 317, 320, 325
 HSV 33
Keterah virus 546, 547
Keystone virus 518, 526
 kinins, rhinoviruses 334
 Koplik's spots 368, 372
 Korean haemorrhagic fever *see*
 haemorrhagic fever with renal syndrome (HFRS)
Kotonkan virus 584
 Kuf's disease 719
Kunjin virus 506, 508
 Kupffer cells, hepatitis 188
 kuru 711, 712–13, 713–14, 725–7
 amyloid plaques 731, 732
 clinical features 725–6
 clinical signs 726
 dementia 725–6
 diagnosis 725
 disappearance of epidemic 716
 epidemiology 725
 Gerstmann–Sträussler–Scheinker disease association 728–9
 incubation 725, 727
 infection 723
 neurological signs 726
 neuropathology *xxiv*, 717, 732
 oral transmission 727
 origin 727
 transmission 717–18, 727
 to animals 727
 Kyananur Forest disease 485, 511–12
Kyananur Forest disease virus 508, 511
 La Crosse encephalitis 521
La Crosse virus 518, 525
 lactose intolerance, adenoviruses 321
 Lafora bodies 719
Lagos bat disease 584
 laryngeal warts
 interferon therapy 617
 recurrence rates 615
 laryngotracheobronchitis 280, 281–2
 adenoviruses 318
 management 289
 laser evaporation for HPV treatment 617

- Lassa fever
 abortion 567
 antiviral therapy 538
 clinical features 566
 diagnosis 567–8
 endemic 567
 epidemiology 567
 history 565–6
 immune plasma 568
 outbreaks 565–6
 paediatric 567
 pathology 560, 561
 pregnancy 568
 prognostic markers 568
 ribavirin therapy 538
 therapy 568–9
- Lassa virus* 551–2, 554, 557, 558
 disease spectrum 566–7
 laboratory culture 567–8
 rodent reservoir 567
 serological tests 568
- latency-associated transcripts (LATs) 26
 HSV 27
 VZV 57
- latex agglutination 3, 4
- Lee-Davidsohn test *see* heterophil antibody test
- Lentiviridae* 248
- Lepus americanus* 526
- leucoencephalopathy, perivascular 35
- ligase chain reaction (LCR) 9–10
- LightCycler system 8
- line probe assays 15
- liver
 acute hepatitis 187–8
 fatty degeneration 264
 fibrosis 225
- liver function
 bilirubin 189
 biochemical tests 188–9
- liver transplantation, HDV 219
- loop electrosurgical excision procedure (LEEP) for HPV treatment 617
- low density lipoprotein receptors (LDLR), rhinoviruses 332
- Lumbo virus* 518, 526
- lung disease, hyperlucent 319
- lymphoblastic leukaemia 653
- lymphocyte-function associated antigen-1 (LFA-1) 332
- lymphocytes, HIV infection 667
- lymphocytic choriomeningitis (LCM) 561–2
 clinical features 561
 epidemiology 562
 pathology 561
- Lymphocytic choriomeningitis (LCM) virus* 551, 552, 553
 antibodies 559–60
 antigenic relationships 557–8
 cell-mediated immunity 559, 560
 cytotoxic T cell response 559
 immune response 558–9
 interferon induction 558–9
 L RNA strand 556
 persistent infection 559–60
- lymphoepithelioma 135, 136
- lymphoma
 immunocompromised patients 132
 nasal T cell 124
see also primary effusion lymphoma (PEL)
- lymphoproliferative syndrome, X-linked (X-LPS) 128, 137, 138
- Lyssa bodies, rabies 598
- Lyssavirus*
 antigenic relationships 585
 genotypes 583–4
 N protein 585
see also rabies
- lyssaviruses 583–4
- Machupo virus* 557, 562
 isolation 564
 pathogenesis 561
 rodent reservoir 564
- α_2 -macroglobulin receptor/LDLR-related protein (α 2MR/LRP) 332
- macrophages, HSV cell-mediated immunity 28–9
- maculopapular rash of erythema infectiosum xx, 650
- Madrid virus* 518, 524–5
- Maguari virus* 518, 523
- major capsid antigen (MCA), VZV 49
- malaria, Burkitt's lymphoma 132, 134
- Mansonia africana* 475
- Marburg virus* 571
 antigens 575
 clinical features 579
 divergence from *Ebola virus* 574
 epidemiology 576
 genome sequence 573–4
 glycoproteins 574
 inactivation susceptibility 573
 pathology 579–80
 proteins 574
 serology 575
 treatment 580
 ultrastructure 573
 virion 572
- Marituba virus* 518, 524–5
- Mastomys* rat 567
- Mayaro virus* 473, 477
- Me Tri virus 482
- measles 357
 acute 371–2
 acute postinfectious encephalitis 370, 371, 374, 379
 incidence 381
 adenovirus pneumonia 319
 atypical 369, 377
- central nervous system 370
 clinical course 367–8
 complications 369–71
 diagnosis 377–9
 elimination 366
 epidemiology 365–7
 developing countries 383
 eradication attempts 379–80
 giant cell pneumonia 369
 immunity persistence 380
 incidence 357
 inclusion body encephalitis 369–70, 374
 Koplik's spots 368, 372
 lymphopenia 372
 management 379
 modified 369
 mortality 357
 multinucleate giant cells 377
 osteitis deformans 371
 otosclerosis 371
 pathogenesis 371–7
 pneumonia 369, 379
 prevention 379–83
 rash 368, 372
 subacute sclerosing panencephalitis (SSPE) 370–1, 374–7
 symptoms 368
 vaccination 357, 377
 adverse reactions 380, 382
 combined with rubella 414
 contraindications 382–3
 developing countries 383
 Edmonston Zagreb strain 380
 effectiveness in control 381–2
 failure 381
 HIV infection 383
 immunocompromised patients 383
 inactivated 380
 live 380–1
 optimum age 383
 schedule 381
 side effects 382
 virus isolation 378
- Measles virus* (MV) 357
 attenuation marker 363
 biological properties 364–5
 budding mechanism 364
 C protein 361
 CD46 362–3, 365
 cell-mediated immunity (CMI) 377, 379, 381
 cellular RNA 361
 central nervous system persistence 358
 cytopathic effects (CPEs) 378
 dendritic cells 373–4
 direct examination 377
 envelope proteins 361–2
 F gene 360
 fluorescence microscopy 377
 fusion (F) protein 358, 361–2, 364, 365, 369

- genome structure 358, 359, 360
genomic RNA 358, 360
haemagglutination test 365
haemagglutinin 364–5
haemagglutinin (H) protein 358, 361, 365
haemolysis 365
HIV infection in children 678
hyperimmunity 371, 376
IL-12 372
 synthesis inhibition 365
immunity 357
immunosuppression 372–4
isolation 378
L protein 361
M gene 360
M protein 362, 364
moesin 362
morphology 358
mRNA 359, 360, 361, 363, 364
multinucleate giant cells 364, 368
myelin basic protein (MBP) 374
N gene 364
N protein 361, 366, 374, 375
P gene 360
P protein 361, 374, 375
Paget's disease 371
pathogenesis 371–7
peplomers 358
persistence 357
projections 358, 360
protein functions 358, 360–2
R protein 361
receptor complex 362
receptor usage 362–3
replication 363–4, 368, 371, 372, 376
 cycle 362–4
RNP complex 358, 363, 374
sample collection 378
serology 377–8
serotype 366
spread prevention 379
stability 364
subacute sclerosing panencephalitis
 364, 366
T cells 372, 373, 381
thermolability 364
transmission 366
tropism 362–3
V protein 361
vaccine strains 363, 366–7
viral RNA detection 378
viral transmembrane proteins 358, 359
virion envelope 358
 Warthin–Finkeldy cells 368
meat and bone meal (MBM) 715, 716, 717
megakaryocytopoiesis, *B19 virus* 649
meningitis
 genital HSV-2 infection 32
 herpetic 44
 infectious mononucleosis 128
 mumps 423
 meningoencephalitis
 mumps 422
 varicella 62
mice, transgenic
 Hu prion transmission 737–8
 prion production 734–5
Microsporidium encephalozitoozon 675
Middleburg virus 469
mink encephalopathy 711
MIP-1 α and MIP-1 β 669
MMR vaccine 395, 411, 413
Mobala virus 557
moesin 362
Mokola virus 584
molecular mimicry, HSV nucleocapsid 25
molecular techniques, clinical use 10–13
molluscum contagiosum 461–2
 clinical features 462
 control 462
 diagnosis 462
 epidemiology 462
 Henderson–Patterson bodies 461
 HIV infection 675
 pathogenesis 461
 prevention 462
Molluscum contagiosum virus (MCV)
 453–4
monkeypox 454–7
 clinical features 456
 control 457
 diagnosis 456
 pathogenesis 455
 reservoir hosts 457
 vaccinia vaccination 457
Monkeypox virus 454–5
 human infection 455, 456
monkeys
 Ebola virus infections 578, 580
 Tanapox virus reservoir 463
 yellow fever reservoir hosts 492
Mononegavirales 358, 571
mononucleosis 94, 101, 103
 CMV 86–7
 see also infectious mononucleosis
Mopeia virus 557
Morbillivirus 358
mosquito-borne encephalitis 491
mosquitoes
 bite control 480, 482
 bite protection 470, 471, 472, 479
 Japanese encephalitis virus 505
 St Louis encephalitis 506
 flavivirus vectors 485
 yellow fever transmission 490
 see also *Aedes* mosquito; *Anopheles*
 mosquito; *Culex* mosquito;
 Culiseta mosquito; *Haemagogus*
 mosquito
Mucambo virus 480
multicentric Castleman's disease (MCD)
 183–4
multiple sclerosis
 coronavirus 352–3
 HHV-6 152
mumps 279, 419
 antibodies 422
 arthralgia 424
 cell-mediated immune reaction 422
 clinical picture 422–4
 clinical symptoms 425
 CNS 422
 complications 423–4
 control 425–6
 deafness 423
 encephalitis 423
 endocardial fibroelastosis 424
 epidemiology 425–6
 immunization 425
 meningitis 423
 meningoencephalitis 422
 myocarditis 424
 orchitis 423–4
 outbreaks in vaccinated populations
 425–6
 pancreatitis 424
 parotid gland 421, 422–3
 parotitis 422–3
 pathogenesis 421–2
 pregnancy 424
 renal dysfunction 424
 vaccination 422, 425, 426
 strains 426
Mumps virus
 actin in virion 419
 antibody assays 424
 antigenic structure 420–1
 excretion 421
 fusion (F) proteins 419
 genome 419–20
 IgM antibodies 424
 interferon 421–2
 isolation 424
 laboratory diagnosis 424
 nucleoprotein 419, 420
 pathogenesis 421–2
 proteins 419, 420
 replicative cycle 421
 RNA 419
 S antigen 421
 serotype 425
 SH genome 420
 supervirions 419
 taxonomy 419
 V antigen 421
 virion 421
 envelope 419
 virus detection 424
 virus shedding into saliva 423
Murine hepatitis virus (MHV) 347
 cellular receptor 349
 central nervous system 353

- Murine hepatitis virus* (MHV) (*cont.*)
 myelin basic protein 353
 tropisms 351
- Murine polyomavirus* 619
- Murray Valley encephalitis 507–8
 clinical features 508
 diagnosis 508
 epidemiology 508
- Murray Valley encephalitis virus* 502, 508
- Murutucu virus* 518, 524–5
- muskrat, Omsk haemorrhagic fever host 511
- mutation detection, individual 15
- myalgia, influenza 262, 264
- Mycobacterium avium*, AIDS 674, 675
- Mycobacterium intracellulare*, AIDS 674, 675
- Mycobacterium tuberculosis*, AIDS 673
- Mycoplasma pneumoniae* 36
- mycosis fungoides, HTLV-I association 704
- myelin basic protein (MBP)
Measles virus (MV) 374
Murine hepatitis virus (MHV) 353
- myelitis, herpes zoster 65
- myocarditis
 neonatal Coxsackie 439
 varicella 62
- myoclonus, Creutzfeldt–Jakob disease 717, 726
- myoglobinuria, influenza 264
- myopericarditis, enteroviruses 438–9
- myositis, influenza 264
- Nairobi sheep disease virus* 536, 539–40
 vaccines 539–40
- Nairobi sheep disease serogroup 536, 539–40
 serology 522
 structure 516
- Nairovirus* 515
 Crimean–Congo haemorrhagic fever serogroup 535
 genus 535–40
- nasal T cell lymphoma 124
- nasopharyngeal aspirate 2
- nasopharyngeal carcinoma 19, 117, 124, 134–6
 clinical factors 135
 cofactors 135
 diagnosis 135, 136
 distribution 131
 EBV antigen 135
 EBV association 134–5
 genetic aetiology 135
 histological types 135
 IgA antibodies to VCA 134, 135
 pathogenesis 134–5
 prevention 136
 seroepidemiology 134
 treatment 136
- vaccination 136
- natural killer cells, HSV cell-mediated immunity 28
- Ndumu virus* 469
- necrotizing enterocolitis, coronavirus 248
- Negri bodies, rabies 597, 598
- neonatal herpes 33–4, 39
 management 44
 perinatal infection 32, 33
- nephropathia epidemica *see*
 haemorrhagic fever with renal syndrome (HFRS)
- Nepuyo virus* 518, 524–5
- neuralgia, herpes zoster 65
- neuraminidase (NA)
Influenza virus 255, 257, 261, 262, 267
 antigen 272, 275
 host response 271
 parainfluenza viruses 287
- neuraminidase-inhibiting (NI) antibody 272, 274
- neurons, spongiform degeneration 729–30
- neurotissue vaccines, rabies 600, 602
- Newcastle disease virus* 279, 419
- Nezelof syndrome 653
- Nidovirales* 345
- non-Hodgkin's lymphoma 127
 HIV/AIDS 677
- normal human immunoglobulin, intravenous (iv-NHIG) 73
- normoblasts, *B19 virus* 649
- Norwalk virus* (NV) 242, 243
 antibodies 245
 prevalence 245
- Norwalk-like viruses 242–3
- nuclear factor (NF) κ B 624, 626–7
 binding site in HTLV-I 705, 706
- nucleic acid detection 6–10
- nucleic acid sequence-based amplification (NASBA) 8, 9–10
- nucleic acid sequencing 15–16
- nucleoside analogues, human polyomavirus infection treatment 640–1
- nucleoside reverse transcriptase inhibitors (NRTI) 682–3
- Nyando virus* 519, 527
- Obodhiang virus* 584
- Ockelbo disease 470, 471
- octamer-binding protein (OCT) 26, 27
- ocular herpes 32
 HSV management 43–4
- Oka vaccine strain, VZV 53, 60
- Oliveros virus* 569
- Omsk haemorrhagic fever 485, 510–11
- Omsk haemorrhagic fever virus* 508
- oncogenic associations, *Herpesviridae* 19
- oncoviruses 660
- Ondatra zibethica* 511
- O'Nyong-Nyong virus* 476
- ophoritis 423–4
- ophthalmic zoster 65
 contralateral hemiparesis 65
 management 72
- oral hairy leucoplakia 124, 138, 673
- oral lesions, AIDS 673
- oral rehydration fluids 236
- orchitis, mumps 423–4
- orf 459, 460
 vaccine for sheep 461
- organ transplantation
 CMV 87–9, 89–90, 91, 94, 151
 antiviral therapy 109
 prevention 105–7
- EBV 137–8
- HCMV 151
- HDV 219
- HHV-6 and HHV-7 141, 151
- KSHV 181
- Oriboca virus* 518, 524–5
- Oropouche virus* 519, 527
- orthopoxvirus 453
 species-specific genome sequences 456
- Ossa virus* 518, 524–5
- osteitis deformans, measles 371
- otitis media
 respiratory syncytial virus 300
 rhinoviruses 337
- otosclerosis, measles 371
- p100 antigen 157
- P antigen 648–9
- Paget's disease 371
- pancreatitis and enteroviruses 440–1
- papillomaviruses 607
 classification 607, 608
 genome 607–8, 609
 oncogenic potential 612–14
 skin lesion electron microscopy 3
 structure 607
see also Human papillomavirus (HPV)
- Papovaviridae* 619
- parainfluenza viruses 279
 acute lower respiratory tract infection 283, 284
 adult infection 282, 285–6
 airways obstruction 282
 antibody conversion 288
 antisera 287, 288
 biological properties 280
 cDNA clone libraries 288
 clinical features 281–6
 croup 280, 281–2, 282–5
 cytoplasmic inclusions 280
 dissemination 289, 290
 economic factors in testing 289
 electron microscopy 287
 enveloped virion 280, 287
 epidemiology 282–6
 fusion (F) glycoprotein 279, 280
 glycoproteins 279–80

- haemadsorption 288
 haemagglutination inhibition 281, 288, 289
 haemagglutinin 287
 haemagglutinin neuraminidase (HN) glycoprotein 279–80
 host cell entry 280
 immunofluorescence 2, 287
 immunology 281
 incubation time for virus growth 288
 isolation tests 286
 laboratory diagnosis 285, 286
 management 289
 morphology 279
 neuraminidase 287
 neutralizing antibodies 284, 288–9
 nosocomial spread limitation 290
 nucleocapsid 280
 pathogenesis 281
 prevention 289–90
 prophylaxis 290
 prototypes 280–1
 radioimmunoassay 289
 RNA 279, 280
 Sendai strain 280
 serological tests 286–7
 serology 288–9
 serotyping of isolate 288
 specimen collection 286
 strains 280–1
 types 283–4
 syncytia induction 280
 taxonomy 279
 tests
 preparation 286–7
 rapid non-cultural 287
 virus isolation 1, 287–8
Paramyxoviridae 279, 358, 571
 electron microscopy 287
 paramyxovirus 419
 group 279
 parapoxvirus 451–2, 459, 460–1
 clinical features 460–1
 control 461
 diagnosis 461
 epidemiology 461
 immune response 460, 461
 pathogenesis 460
Parvoviridae 235, 645
 classification 646
Parvovirinae 645
 parvovirus 235, 244, 248
 autonomous 648
 genomes 646
 particles 646
 see also *B19 virus*
 Paul–Bunnell test see heterophil antibody test
 penciclovir
 herpes zoster 72
 HSV 41
 penile cancers 614–15
 peplomers
 Bunyavirus 516
 Measles virus 358
 peripheral blood mononuclear cells (PBMNs) 3
 peripheral leucocytes, human
 polyomavirus target cells 632
 persistent viral fatigue syndrome (PVFS), infectious mononucleosis 128, 129
 pertussis syndrome, adenoviruses 319
Peste de petit ruminants virus (PPRV) 358
Pestivirus 485, 486
 antigenic properties 490
 biochemical/biophysical properties 489
 genome 488
 pharyngoconjunctival fever, adenoviruses 317, 319–20
 phenotypic assays, drug resistance 15
Phlebotomus papatasi 528
Phlebotomus perniciosus 528–9
Phlebovirus 515
 genome 517
 genus 528–35
 sandfly fever serogroup 528–35
 Uukuniemi serogroup 529, 535
Phocine distemper virus (PDV) 358
 phytohaemagglutinin, HIV propagation 664
Pichinde virus 552, 553, 557
 picobirnavirus 235, 248
Picornaviridae 192, 235, 247, 427
 picornavirus 244
 pituitary, prion concentration 723
 placenta, VZV crossing 63
 plaque reduction assay (PRA) 14
 plasmids 7
 pleurodynia, epidemic 438
Pneumocystis carinii pneumonia 662, 671, 673–4
 pneumonia
 adenoviruses 318–19, 319, 325
 bacterial 263–4
 giant cell in measles 369
 influenza 263–4
 measles 369, 379
 parabacterial 4
 respiratory syncytial virus 299, 301
Pneumovirus 293
 see also respiratory syncytial virus (RSV)
 Pogosta disease 470
 point mutation assays 15
 poisoning, rabies differential diagnosis 597
 poliomyelitis 436
 rabies differential diagnosis 597
 poliovirus 247, 427, 428, 434, 435
 CNS access 444
 elimination 446
 genome 433
 hypogammaglobulinaemia 446
 infection 436
 prevention 444–6
 replication strategy 432
 type 3 431
 vaccine
 developing countries 445
 inactivated 444–5, 446
 live attenuated administered orally 445–6
 virus shedding 446
 wild-type 446
 polymerase chain reactions (PCR) 3, 6–9
 amplification 7
 clinical specimen preparation 7
 contamination 8–9
 control reactions 8–9
 control sequence 7–8
 kinetic 8
 multiplex 7
 nested 38
 physical requirements 9
 primers 6
 product detection 7
 quality control 9
 quantitation 7–8
 real-time 8
 polyomaviruses see human polyomaviruses
Pongola virus 524
 popovyllin 616–17
Porcine epidemic diarrhoea virus (PEDV) 347
Porcine haemagglutinating encephalomyelitis virus (HEV) 347
Porcine transmissible gastroenteritis (TGEV) 347
Porpoise morbillivirus (PMV) 358
 postpolio syndrome 436
Porassan virus 508, 512
Poxvirus, HIV infection 675
 poxviruses 451
 A-type inclusions 453, 455
 antigenic structure 452–3
 B-type inclusions 453
 C (capsule) form 452, 453
 chemical structure 452
 cultivation 453–4
 diagnosis 463–4
 EEV 452, 453, 454
 gene expression studies 451
 gene products 454, 455
 genetic hybridization 451
 genome 452
 haemagglutinin 453
 human pathogens 451, 452
 infectivity 464
 INV 452, 453
 M (mulberry) form 452, 453
 morphology 451–2
 pathogenesis 454

- receptors 453
- poxviruses (*cont.*)
- recombinant vaccines 458
- replication 453–4
- skin lesion electron microscopy 3
- vaccine vectors 451
- virion 452
 - membranes 452, 454
- virulence expression 454, 455
- ppUL83* protein 96
 - CMV 91
- pregnancy 88, 89, 90, 91, 95–6
 - B19 virus* 652–3, 654
 - CMV 86
 - future 101–2
 - primary 103, 104
 - termination 103–4
- genital warts 615
- hepatitis 189
- HIV infection 678
- human polyomaviruses 633
- infectious mononucleosis 128
- influenza 264–5
 - secondary bacterial pneumonia 264
- Lassa fever 568
- measles vaccine contraindication 382
- mumps 424
- rubella reinfection 397
- rubella vaccination 411, 412
- varicella 62–4, 71, 74
- VZV contact 74
- yellow fever vaccination 495
- primary effusion lymphoma (PEL) 167, 171, 183
 - latent genes 183
- primates, subhuman as *Dengue virus*
 - hosts 498
- primer sequence design 6
- primer–dimer amplification 6
- prion diseases 711–12
 - amyloid plaques 713
 - animal 711, 714–16
 - gene therapy 723
 - genetic and infectious 740
 - human 712–13, 732–5
 - inherited 735–6
 - human 732–5
 - neuropathology *xxiv*, 729–32
 - PrP gene mutations 733–4
 - selective neuronal targeting 730
 - sporadic 735–6
 - terminology 713–14
- prions
 - BSE 715–17
 - chaperones 742
 - composition 711–12
 - concept 740
 - de novo* generation in transgenic mice 734–5
 - DY strain 739
 - infectivity measurement 714
 - oral route of infection 718
 - passage
 - between species 737
 - in mice 714
 - propagation
 - mechanism 736–7
 - methods 722
 - rate-limiting step in formation 736
 - replication 735–8
 - rate-limiting step 737
 - strains 738–40
 - PrP^{Sc} conformation variation 740, 741
 - templating process 736, 737
 - transgenic mice 714, 717
 - transmission across species barrier 737
- PRNP gene 713
 - mutations 714
 - sporadic Creutzfeldt–Jakob disease 717
 - point mutations in
 - Gerstmann–Sträussler–Scheinker disease 728
- progressive multifocal
 - leucoencephalopathy (PML) 619, 620
- AIDS 636, 641, 674
- diagnosis 638
- HIV infection 631–2
- human polyomavirus infection
 - treatment 640–1
- JC virus* 635–6, 639, 674
 - populations 628
 - primary infection 630
 - specific antibodies 640
 - spread to CNS 631–2
- lesions 635–6
- polyomavirus demonstration in CSF 629, 638–9
- transcriptional control elements (TCR) 629
- promoter insertion hypothesis 218
- Prospect Hill virus* 541, 542
- protease gene 15
- protease inhibitor drugs 683, 684
- protein 14–3–3 levels 719
- protein X
 - binding site *xxiii*, 723
 - CJD therapeutics 722
 - evidence for 737–8
 - molecular chaperone 738
 - PrP^C *xxiii*, 715, 717
 - binding 735
 - PrP^{Sc} 736–7
- proteins, chaperone functions 742
- prothrombin time 189
- PrP*/protein X complex 735
- PrP
 - antiseria 720
 - Bcl-2 interactions 738
 - Hsp60 interactions 738
 - immunostaining of amyloid plaques 721
 - laminin receptor protein binding 738
 - polypeptide chain *xxiii*, 716
 - protective effects of polymorphic residues 738
 - protein aberrant metabolism 741
 - recombinant 735
 - transgenes 714, 730
- PrP gene 711–12
 - 27–30 sequence 732
 - alleles *xxiii*, 716
 - bovine sequence 716
 - conformational templates 736
 - E200K mutations 736
 - genetic ablation 712
 - molecular clone sequencing 732
 - mutations 711, 713, 714, 740–1
 - in familial prion diseases 733–4
 - in Gerstmann–Sträussler–Scheinker disease 729
 - human disease 712, 713–14
 - point mutations in
 - Gerstmann–Sträussler–Scheinker disease 732
 - polymorphisms 716, 734
 - scrapie *xxii*, 715
- ΔPrP(E200K) 736
- PrP^C 713
 - conversion to nascent PrP^{Sc} 739
 - conversion to PrP^{Sc} interference 722
 - mechanism of PrP^{Sc} formation 741
 - protein X *xxiii*, 715, 717
 - binding 735
 - binding site 722
- PrP^{Sc} 711–12
 - barrier to formation 736
 - CNS dysfunction 712
 - conformation
 - in BSE and CJD 725
 - enciphering prion variation 739
 - variation with prion strain 740, 741, 742
 - deposition 730
 - formation
 - in caveolae 722–3
 - in caveolae-like domains (CLDs) 712
 - in vitro* 735
 - immunoassay 717, 721
 - infected hamster brains 740
 - kinetics of accumulation 737
 - mechanism of formation 741
 - prion composition 720
 - protease-resistant 720, 721
 - fragment 739
 - protein X 736–7
 - proteinase K-sensitive fraction 740
 - rate-limiting step in formation 737
 - strain-specific information enciphering 739
 - structure destabilization 723

- template function 739
- tertiary structure *xxiii*, 742
- therapeutic strategies 722–3
- public health
 - diarrhoeal disease 236–7
 - SRSVs 245–6
- Punta Toro virus* 529
- Puumala virus* 541, 542, 543, 544–5
- pyruvate kinase deficiency 652
- Q_{Lim} 39
- rabies 583
 - animal 588–90
 - cardiac dysrhythmias 595
 - cell culture vaccine safety 602–3
 - clinical course 594–5
 - CNS involvement 591–2
 - complications 595–6
 - diagnosis 597–8
 - differential diagnosis 597–8
 - disease patterns 594–5
 - dogs 590
 - dumb 594–5
 - early death phenomenon 593
 - encephalitic 598, 605–6
 - enzootic 588
 - epidemiology 588–90
 - foxes 589
 - furious 594, 595, 605–6
 - heterologous antirabies immune globulin (HRIG) 599–600, 602
 - human 590
 - human disease incidence 590
 - human-to-human transmission 591
 - hydrophobia 594, 596
 - immunity assessment 604–6
 - immunization
 - animals 589, 590
 - passive 599–60
 - incubation 592–3
 - infection
 - factors 592
 - modes 590–1
 - reservoir 589, 590
 - itravitem diagnosis 597
 - laboratory accidents 591, 593
 - Lyssa bodies 598
 - management 598–9
 - mortality 593
 - onset 594, 595
 - paralytic 594–5, 606
 - pathogenesis 591
 - peripheral nerves 591
 - phobia 596
 - postexposure prophylaxis 599–604
 - efficacy 601–2
 - postexposure treatment failure 603–4
 - postmortem diagnosis 597–8
 - pre-exposure immunization 590
 - pre-exposure prophylaxis 604
 - prevention 599–606
 - prodrome 594
 - protection 605
 - racoon 589
 - respiratory disturbance 595–6
 - salivary gland mucosal epithelium 592
 - sylvatic 589
 - transmission 590–2
 - vertical 591
 - urban 589
 - vaccination
 - booster doses 604
 - multisite intradermal 602
 - safety 604
 - vaccine 599–601
 - duck embryo 600
 - human diploid cell (HDCV) 600–1, 602, 603
 - neurotissue 586, 600, 602, 605, 606
 - primary chick embryo cell culture (PCECV) 601, 602, 603
 - primary hamster kidney cell (PHKC) 601, 603
 - production 585, 588
 - purified Vero cell rabies (PVRV) 601, 603
 - reactions 597
 - SMBV 600, 602
 - wound treatment 599
 - see also Lyssavirus*
 - Rabies virus*
 - antibody 605
 - antigen demonstration in brain 598
 - cell-mediated immunity 605–6
 - cerebrospinal fluid examination 597
 - chemical agent effects 588
 - chemical structure 586
 - classification 583
 - corneal transplantation 591, 595
 - cytopathic effect (CPE) 604
 - defective interfering (DI) particles 586
 - ELISA 604–5
 - excretion in saliva 592
 - glycoprotein G 587
 - immunofluorescence testing 597
 - immunofluorescent staining 604
 - in vitro* growth 588
 - L protein 587
 - M1 phosphoprotein 586–7
 - M2 protein 587
 - morphology 585–7
 - mouse neutralization test 604–6
 - N protein 586
 - Negri bodies 597, 598
 - nested PCR methods 598
 - neutralizing antibody 605
 - physical agent effects 588
 - receptors on muscular cells 591
 - replication 587–8
 - RNA 586
 - transcription 588
 - serum antibody detection 597
 - surface projection layer 585
 - translocation to CNS 591–2
 - ultrastructure 586
 - virion 586, 587, 588
 - radiculomyelitis, sacral 32
 - 'rante de laboratoire' 591, 593
 - Ramsay Hunt syndrome 64
 - RANTES 669
 - rapid rabies enzyme immunodiagnosis 598
 - regulators of complement (RCA) gene family 362
 - renal damage, varicella 62
 - renal disease, secondary bacterial pneumonia in influenza 264
 - renal transplantation
 - adenoviruses 320, 321–2
 - human polyomaviruses 633
 - Reoviridae* 235, 247
 - reovirus 235
 - gastrointestinal 247–8
 - resistance, antiviral drug *see* drug resistance
 - respiratory disturbance in rabies 595–6
 - respiratory syncytial virus (RSV) 293
 - acute respiratory infection 285
 - adult infection 301
 - antigenic variations 294
 - apnoea 300
 - atopy 300–1
 - attack rate 295
 - bronchiolar lumina obstruction 296
 - bronchiolitis 286, 296, 297, 299
 - hyperinflation 296
 - bronchitis 299
 - bronchodilators 303
 - bronchopulmonary dysplasia 300
 - cellular immunity 298
 - children at risk from severe disease 300
 - clinical features 298–301
 - complications 300–1
 - contagiousness 295
 - croup 282, 283
 - cytopathic effect 302
 - cytoplasmic inclusions 294
 - diagnosis 301–2
 - elderly 301
 - enzyme immunosorbent assays 301, 302
 - epidemics 295, 304
 - epidemiology 294–6
 - F proteins 293, 294, 297, 298, 304
 - G proteins 297, 298, 304
 - genetic engineering 304
 - hospital staff attack rate 296
 - hyperinflation 299
 - hypoxaemia 299, 302
 - IgE antibody 297
 - immune response 293–4, 298
 - immunity 296–7

- respiratory syncytial virus (RSV) (*cont.*)
immunofluorescence 2, 301
immunoprophylaxis 304
immunosuppression 300, 301
infections 293
 live 298
 older children 301
 primary 299–300
lower respiratory tract infection 295,
 296, 298–9, 300
lung radiology 299
management 302–4
maternal antibody 297
neonates 299–300
neutralizing antibody response 298
nosocomial hazard 295
nosocomial spread prevention 304
otitis media 300
outbreaks 294–5
pathogenesis 296–8
pathology 296
pneumonia 299, 301
prevention 303–4
proteins 293–4
pulmonary function 300–1
rapid assays 301
ribavirin therapy 302–3
self-inoculation 296
serological diagnosis 302
specimen collection 301
spread 296
strains 294
structure 293, 294
syncytia formation 302, 303
taxonomy 293
T_H1 helper cell response 298
tissue culture 294, 301–2
transplant units 295–6
vaccine
 development 303–4
 inactivated 297–8
 virus isolation 1
respiratory tract infection
 adenoviruses 318–19, 325–6
 B19 virus 647–8, 650
 coronaviruses 345, 351
 enteroviruses 438
respiratory syncytial virus 295, 296,
 298–9, 300
Resopovirus 279
Restan virus 518, 524–5
restriction fragment length
 polymorphism (RFLP) assay 15
reticular pattern of erythema infectiosum
 xx, 651
retinal necrosis, acute
 diagnosis 67
 VZV 65
retinal necrosis, progressive outer
 (PORN) 65–6
 diagnosis 67
retinitis 110
 AIDS 155
 CMV 94
 HCMV 155
 HHV-6 155
retinopathy, congenitally-acquired
 rubella 400, 401
Retroviridae 235, 248
retroviruses 659–60
 animal diseases 659
 classification 660–1
 complex genome 661
 core proteins 660
 env 660
 gag gene 660
 genes 660
 genome 660
 human infections 661
 long terminal repeats 660
 outer surface protein 660
 pol 660
 provirus 659
 replication cycle 659
 simple genome 661
Rev-response elements (RREs) 665
reverse transcriptase 9, 659
 gene 15
reverse transcriptase-PCR 15
Reye's syndrome 62
 influenza 264, 265, 270
Rhabdoviridae 571, 583
rhadinoviruses 168
Rhesus monkey papillomavirus 1 612
rheumatoid factor 4, 5
rhinovirus 14 430
rhinoviruses 329
 antigenicity 330–1
 antiviral therapy 340–1
 asthma exacerbation 335, 337
 canyon 330, 331
 capsid 330
 clinical features 336–7
 common cold 329, 336
 complications 337
 cytopathic effect 338
 diagnosis 338–9
 epidemiology 336
 genome 332, 333
 histamine 334
 host range 334
 ICAM-1 332, 341
 IgG and IgA serum antibodies 335
 immune mediators 334, 335
 immune selection 329
 immunity 335–6
 incubation 333–4
 inflammatory mediators 340
 internal ribosome entry site 332
 kinins 334
 LDLR 332
 LFA-1 332
 morbidity 336–7
 α 2-MR/LRP 332
 mutation 329
 nasal mucous membrane
 cytopathology 334
 neural pathway 334
 neutralizing immunogenic sites 330–1
 nucleic acid detection 339
 otitis media 337
 paranasal sinus occlusion 334
 pathogenesis 334–5
 physical properties 333
 pocket factor 330
 prevention 340
 receptors 332, 341
 replication 332–3
 RNA 332–3
 serology 339
 serotypes 329, 331
 sinusitis 337
 structure 330–3
 symptoms 336
 taxonomy 329
 temperature sensitivity 333
 transmission 333–4
 treatment 340–1
 vaccine development 340
 viability 333
 viral proteins 330, 332
 virus eradication 335–6
 virus isolation 1
Rhipicephalus appendiculatus 539
ribavirin therapy
 Lassa fever 538
 respiratory syncytial virus 302–3
Rift Valley fever 520, 529–35
 abortion 533
 benign 535
 encephalitic form 533
 endemic areas 530
 epidemics 530–1, 532
 epidemiology 530
 haemorrhagic form 533
 haemostatic derangement 534
 histopathology 535
 human infection 532–3
 livestock vaccination 531
 mortality 533
 ocular changes 533
 outbreaks 531, 532
 pathogenesis 533–4
 spread to Egypt 531
 symptoms 533
 transmission 531, 532
 treatment 534
Rift Valley fever virus 521, 529
 antibody 535
 maturation 517
 structure 516
 vectors 529, 530, 531
 wild 534

- Rinderpest virus (RPV)* 358
 Rio Bravo virus 491
 RNA polymerase 9
 RNA probes 6
 RNase H 9
Rochambeau virus 584
 Rocio disease 485
Rocio virus 496
 rodents
 arenavirus reservoir 552–3
 cowpox infection 458, 460
 rolling circle mechanism, VZV 51
 roseola infantum *see* exanthem subitum
Ross River virus (RRV) 470, 471–3, 474
 clinical features 472
 diagnosis 473
 epidemiology 472
 host range 472
 pathogenesis 473
 vaccine 473
 rotavirus 235, 236, 236
 classification 237–8
 diagnosis 240–1
 epidemiology 241
 gene proteins 237
 genome 237
 illness 240
 immune response 240
 latex agglutination 3
 pathogenesis 239–40
 protection correlates 240
 protein products 238, 240
 RNA profile 237
 structure 237
 treatment 241
 vaccine 240, 241
 viroplasm 239
 rubella 387–9
 antibody screening 406
 antibody titre rise detection 407
 atypical 396
 congenital infection 394
 congenital malformations 387
 congenitally acquired 389, 395, 398–405
 cardiovascular anomalies 404
 cataract 404, 405
 clinical features 401–5
 CNS 402–3, 403–4
 deafness 403
 developmental defects 403
 glaucoma 404
 late-onset disease 404
 nerve deafness 399
 ocular defects 404
 outlook for children 404–5
 permanent defects 404
 postnatal diagnosis 407–9
 prenatal diagnosis 409
 retinopathy 404
 transient anomalies 402–3
 transmission risk 409
 virological diagnosis 407–9
 diagnosis 406–7
 endothelial cell damage 398
 epidemic 389
 epidemiology 394–5
 fetal anomalies 398, 400
 fetal entry 398
 fetal risk 400
 herd immunity 414
 IgG 396, 397
 immunization
 high-titred rubella immunoglobulin 415
 normal human immunoglobulin 415
 passive 414–15
 post partum 413
 universal childhood 413, 414
 incidence 394
 incubation period 395
 joint involvement 396, 397
 lymphadenopathy 396
 maternal 389
 after first trimester 400–1
 in first trimester 400
 risk 387
 postinfectious encephalopathy 396
 postnatally acquired infection 394–8
 preconceptual 401
 pregnancy
 blood tests 405
 congenital infection testing 406
 serological assessment 405–6
 prevention 410–15
 primary infection 395–7
 products of conception 398
 rash 395–6, 397
 reinfection 397–8
 diagnosis 407
 thrombocytopenia 396
 transmission 395
 vaccination 409–14
 combined with measles 414
 contraindications 411
 developing countries 414
 during pregnancy 412
 failure 411
 HIV infection 411
 immune response 410
 policies 413–14
 pregnancy 411
 programme 395
 reactions 410–11
 reinfection 411–12
 selective 414
 seroconversion 411
 viraemia 412
 virus excretion 410
 viraemia 396
Rubella virus (RV) 419
 antibodies 395
 antigenic characteristics 391, 393
 astrocytes 399
 budding 391
 cell culture growth 393
 cell entry 390
 cell-mediated response 393
 central nervous system 399
 chemical properties 391
 classification 389
 cytopathic effect (CPE) 388, 393, 407
 detection 407
 envelope 389
 genome 389, 392
 haemagglutinin inhibition (HI) test 388–9
 humoral response 393
 immune tolerance 399
 interference 393
 isolation 388
 nucleocapsid 389
 pathogenicity in animals 393–4
 persistence 398–400
 proteins 390–1
 receptor-mediated endocytosis 390
 replication 390–1
 RNA 389, 392
 detection in amniotic fluid 409
 saliva tests 407
 serological tests 395, 406–7
 serology 5
 spikes 389, 390
 stability 391
 structure 389, 390
 T cells 399–400
 teratogenicity 394, 400, 401
 tissue tropism 390
 virions 390, 391
 virology 387–9
 rubella-neutralizing antibodies 388
 rubella-specific IgG 406, 407, 408–9
 rubella-specific IgM 405, 406, 407, 408, 409
 detection 406–7
Russian spring–summer encephalitis (RSSE) virus 508, 509
 clinical features 510
 control 510
 epidemiology 509
 S-100 protein 719
Sabia virus 569
 St Louis encephalitis
 clinical features 505
 control 506
 diagnosis 505
 epidemiology 505
St Louis encephalitis virus 502, 503, 505–6
Salmonella 675
 sandfly fever 528, 529
 scrapie 711, 713
 assay 714

- scrapie (*cont.*)
 eradication programme 715, 723
 incidence 717
 protein X 715
 PrP gene polymorphisms *xxii*, 715
 sheep and goats 714–15
 transmissibility 715
- scrum pox 36
- Semliki Forest virus* 469, 473, 482
- Seoul virus* 541, 542, 543
- sequence relatedness 13
- serology 3–5
- serum responsive element (SRE), HTLV-1 705
- severe combined immunodeficiency (SCID) 29
- SRSVs 245
- sexual transmission
 CMV 87
 HBV 199
 hepatitis C 226
 infectious mononucleosis 125
 KSHV 180–1
- shellfish, SRSVs 244, 245
- Shigella* 675
- shingles *see* herpes zoster
- shipping fever 280, 281
- Shokwe virus* 518, 523
- Shuni virus* 519, 528
- sickle cell anaemia
 aplastic crisis 646
B19 virus 652
- sickle cell trait, Burkitt's lymphoma 132
- Simbu viruses 519
- Simian foamy virus type 6* (SFV-6) 661
- simian immunodeficiency virus (SIV) 669
- simian T-cell lymphotropic virus I (STLV-I), HTLV-I relationship 699, 700–1
- simian T-cell lymphotropic viruses 696
- Simian virus* 5 419
- Simian virus* 40 (SV40) 619
 DNA replication 623
- simian viruses, VZV 54, 55
- Sin Nombre virus* 541, 542
- Sindbis virus* 468, 470–1
- sinusitis, rhinoviruses 337
- Sjögren's syndrome, HTLV-I association 704
- Skalica virus* 510
- skin
 papillomas 607
 VZV lesions 55, 57
- slapped-cheek appearance of erythema
 infectiousum *xx*, 650
- slim disease *see* acquired immune deficiency syndrome (AIDS)
- small round structured virus (SRSV) 235, 236, 242–6
 classification 243–4
 clinical course 244, 245
- diagnosis 244
- epidemiology 245–6
- genome 242–3
- immune response 244–5
- nosocomial infection 245
- prevention 246
- replication 244
- serotypes 244
- structure 242–3
- viral shedding 245–6
- small round virus (SRV) 244
 parvovirus 248
- smallpox 451, 454
 lesions 60–1
 monkeypox differentiation 456
- Snowshoe hare virus* 518, 526
- Songo fever *see* haemorrhagic fever with renal syndrome (HFRS)
- spherocytosis, hereditary 652
- squamous cell carcinoma 607
 epidermodysplasia verruciformis 613
- squamous intraepithelial lesions, low-/high-grade 613, 615
- squirrels, monkeypox reservoir hosts 457
- Staphylococcus aureus* and influenza 263–4, 265
- steroid therapy in HSV 43
- Stevens–Johnson syndrome 36
- Sträussler's disease *see*
 Gerstmann–Sträussler–Scheinker disease
- stroma, herpetic eye disease 44
- stromal derived factor 1 (SDF-1) 669
- Strongyloides stercoralis*, HTLV-I association 704
- subacute sclerosing panencephalitis (SSPE) 364
 diagnosis 378–9
 EEG pattern 370–1
 immunology 376–7
 incidence 381
 isolates 375
 measles 364, 366, 370–1, 374–7
 MV N proteins 375
 MV P proteins 375
 treatment 379
 virology 375–6
 virus isolation 379
- sudden infant death syndrome, influenza 265
- syncytia formation, respiratory syncytial virus 302, 303
- T cells
 EBV seropositivity 136
 HSV cell-mediated immunity 29
 immunotherapy in CMV 107
 infectious mononucleosis 126
Japanese encephalitis virus 503
Measles virus (MV) 372, 373, 381
 response 4
- Rubella virus* (RV) 399–400
 X-LPS 137
- Tacaiuma virus* 518, 524
- Tacaribe virus* 552, 553, 555, 557, 559
- TAg
 JCV 625, 626
 oncogenic potential 636, 637
- Tahyna virus* 518, 526
- Tanapox virus* 462–3
- TaqMan system 8
- Tataguine virus* 546–7
- tetanus, rabies differential diagnosis 597
- Tete serogroup of bunyaviruses 519
- β -thalassaemia intermedia 652
- thrombocytopenic purpura 402, 403
- thymidine kinase 159
 gene mutations 40, 41, 73
 VZV 49
- thymidylate synthetase 49
- tick-borne encephalitis 491, 508–10
 clinical features 510
 control 510
 diagnosis 510
 epidemiology 509
 Far Eastern subtype 508
 infection acquisition 509
 vaccines 510
- tick-borne fever, Crimean–Congo haemorrhagic fever 536
- ticks, flavivirus vectors 485
- α TIF 25, 26, 27
- Tinaroo virus* 519, 527–8
- tissue culture, median infective dose (TCID50) 7
- Togaviridae* 467, 520
- toroviruses 235, 248, 345
 antigenic structure 349
 genome sequencing 354
 haemagglutinin-esterase (HE) protein 347, 348, 349
 human enteric tract 352
 protein sequence 348–9
 spikes 346, 347–8
 structure 346, 347–8
- tropism molecular basis 351
- Toscana virus* 528–9
- toxic shock syndrome, influenza 265
- Toxoplasma gondii* in AIDS 673, 674
- tracheobronchitis 263
- trans-Golgi network* (TGN), VZV 51
- transcapsomeric channels in *Herpesviridae* 24
- transfusion transmitted virus (TTV) 229, 645
- transmission of infection 13
- transplant patients 12
 CMV 11
 protocol for virological monitoring 16
- transplant units, respiratory syncytial virus 295–6
- transverse myelitis, herpes zoster 65

- traumatic herpes 36
tumour necrosis factor (TNF) receptor 667
Turkey coronavirus (TCV) 347
Tzanck cells *see* giant cells, multinucleate
- Uganda S virus 491
UL97 gene 15
uracil-*N*-glycosylase (UNG) 8–9
urban yellow fever 485
urinary tract, herpes zoster 64
Uukuniemi 519
Uukuvirus 515
uveitis, HTLV-1 704
- vaccine vectors, adenoviruses 326
Vaccinia virus 451, 452, 453, 454
 Hind III restriction map of
 Copenhagen strain 452, 455
 influenza vaccine 274–5
vaccination 457
valaciclovir
 herpes zoster 72
 HSV 41, 43
 varicella 70
varicella 47
 active immunization 74–6
 acyclovir therapy 69–70, 73
 adult infections 71
 bacterial infection 61
 childhood infection 71
 clinical features 60–2
 complications 61–2
 congenital infection 63
 congenital syndrome 63, 71
 famciclovir therapy 70
 haemorrhagic chickenpox 62
 IgM antibody detection 69, 70
 immunity 71
 immunization programmes for children 75
 immunocompromised patient 71, 75
 incubation period 60
 intrauterine infection 63, 64
 management 69–71
 meningoencephalitis 62
 passive immunization 73–4
 pneumonia 61–2
 pregnancy 62–4, 71, 74
 prevention 73–6
 prophylaxis 73
 postexposure 75
 rash 60–1
 retinitis 65–6
 sepsis 61
 serological diagnosis 67–8
 vaccination 74–6
 vaccines 47
 valaciclovir therapy 70
 VZIG treatment 63, 73, 74
 see also Varicella zoster virus (VZV)
- varicella zoster immune globulin (VZIG) 63, 73–4
Varicella zoster virus (VZV) 47
 acyclovir prophylaxis 73
 age group shift 59–60
 AIDS 675
 antibodies 54
 antigen sharing with HSV 53–4, 68
 antigenic properties 52–4
 assembling proteinase/assembly protein complex 49
 attachment to cell 50
 capsid 51
 cell culture 51–2
 cell-mediated immunity 58
 clinical features 60–6
 complement fixation 68
 CPE 51, 52, 67
 cytology 66–7
 diagnosis of infection 66–9
 DNA 55
 detection 67
 drug resistance 14, 72–3
 early proteins 50, 51
 electron microscopy 66
 ELISA 69
 envelope 51
 epidemiology 58–60
 exocytosis 51
 FAMA technique 69
 ganglionic damage 58
 gB glycoprotein 53
 gene map 49
 genes 50
 genome 48–9
 nucleotide diversity 52
 glycoproteins 49
 HIV infection in children 678
 HSV cross reactivity 53–4, 68
 IgG antibody avidity 68
 IgM antibody detection 69, 70
 immediate-early proteins 50, 51
 immunity 56
 immunofluorescence 2, 67, 68–9, 68
 incidence 58–9
 intranuclear inclusions 52, 53
 isolate identification 67, 68
 isolation 1, 67, 68
 late proteins 50, 51
 latency 56–8
 latex agglutination 3
 LATs 57
 leucoviraemia 55
 major capsid antigen 49
 management 69–73
 molecular epidemiology 60
 monoclonal antibody staining 67
 multiplex PCR 7
 neutralization 69
 non-human primate infections 54–5
 open reading frames 49
- passive immunization 73–4
pathogenesis 55–6
PCR 67
plaque reduction assay 14
pregnancy 74
prevalence 59
prevention 73–4
proteins 49–50
reinfection 56
replication 50–1
Reye's syndrome 264
RFLPs 60
rolling circle mechanism 51
serological diagnosis 67–9
serological type 52
simian virus cross reactivity 54
skin lesions 55, 57
strain variation 52–4
tegument proteins 50
thymidine kinase 49
thymidylate synthetase 49
trans-Golgi network 51
vaccine 52, 53, 60, 74–6
viral antigen detection 52
virion structure 48
 see also herpes zoster; varicella
Venezuela haemorrhagic fever 569
Venezuelan equine encephalitis (VEE) 469
Venezuelan equine encephalitis virus 480–2
 clinical features 481
 control 482
 diagnosis 481–2
 pathogenesis 481
 prevention 482
Vesiculovirus 583
viraemia, low-level 11
viral encephalitis, rabies differential diagnosis 596–7
viral genome
 qualitative detection 11
 sequencing 13
Virchow–Robin spaces 636
virion host shut-off protein (VHS) 25
viroplasm 239
virus
 isolation 1–2
 qualitative/quantitative detection 11
Von Magnus phenomenon 255
- Wanowrie virus* 547
Warthin–Finkeldy cells 368
Wesselsbron virus 496–7
West Nile disease
 clinical features 507
 control 507
 epidemics 506–7
West Nile virus 485, 487, 502, 503, 506–7
 epidemiology 506–7
 features 506
 host range 506

- Western equine encephalitis (WEE) 469
Western equine encephalitis virus 479–80
 Wiskott–Aldrich syndrome 29
 woodchuck hepatitis virus (WHV) 217
Wyeomyia virus 518, 524
- yellow fever
 clinical features 493–4
 control 494–6
 diagnosis 494
 differential diagnosis 493
 endemic zones 495–6
- enzootic forest cycle 492
 epidemics 492, 494
 host factors 494
 immunization contraindications 495
 international travellers 495
 jungle cycle 492–3
 transmission cycles 492–3
 urban cycle 493, 494
 vaccine 495
 vector control strategies 496
Yellow fever virus 486, 488–9, 490, 491,
 492–6
- epidemiology 492–3
 geographic distribution 492
- zidovudine (ZDV) 682–3
 zoster
 aural 64
 immunoglobulin (ZIG) 73
 ophthalmic 65, 72
 sine herpetic 64
 zoster-associated pain (ZAP) 65,
 71

Index compiled by Jill Halliday